

### General Description

The MIC2224 is a high efficiency 2MHz PWM synchronous buck switching regulator optimized for powering 2.5G and 3G CDMA RF Power Amplifiers. The output voltage of MIC2224 can be dynamically adjusted with an external DAC to maximize PA efficiency versus required output power. When the PA requires the highest power, the DAC can be used to enable a low on-resistance, 40mΩ, bypass switch that powers the PA directly from the battery.

The 2MHz PWM operation of MIC2224 allows the smallest possible components. It also allows the device to easily meet stringent W-CDMA  $V_{OUT}$  response specifications.

The MIC2224 operates from a 2.7V to 5.5V input, making it ideal for single cell Li-Ion applications. The device features built-in power MOSFETs that can supply up to 600mA of output current in PWM mode, or over 1A in bypass mode. The MIC2224 can operate with a maximum duty cycle of 100% for use in low-dropout conditions.

The MIC2224 has a junction temperature range of  $-40^{\circ}\text{C}$  to  $+125^{\circ}\text{C}$  and is available in a 10-pin 3mm x 3mm MLF<sup>®</sup> package.

Data sheets and support documentation can be found on Micrel's web site at [www.micrel.com](http://www.micrel.com).

### Features

- 2.7V to 5.5V input voltage range
- DAC-adjustable output voltage down to 0.3V
- 600mA output current in PWM mode
- Internally protected 40mΩ bypass switch
- Allows direct connection of battery to load
- Over 95% efficient
- Fully integrated MOSFET switches
- Constant 2MHz PWM operation
- Internal soft-start
- 1% line and load regulation
- $<1\mu\text{A}$  shutdown current
- Under-voltage lockout
- Thermal shutdown and current limit protection
- $-40^{\circ}\text{C}$  to  $+125^{\circ}\text{C}$  junction temperature range

### Applications

- Cellular phones
- PDAs

### Typical Application

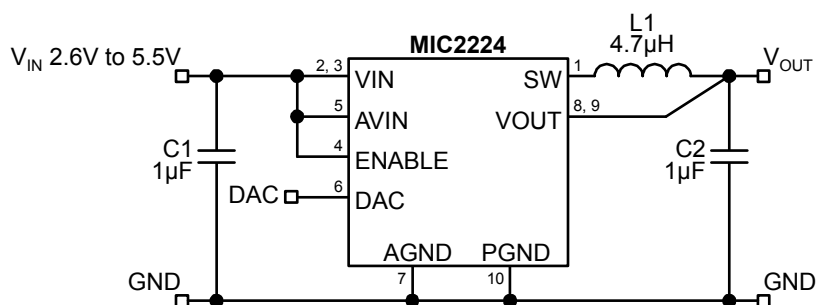

2MHz PWM Converter with DAC Input and 40mΩ Bypass Switch

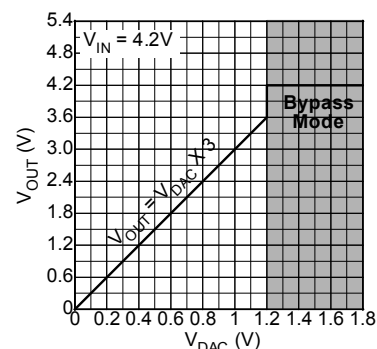

## Ordering Information<sup>(1)</sup>

Part Number	Output Voltage	Junction Temp. Range	Package	Lead Finish
MIC2224YML	Adj.	-40°C to +125°C	10-Pin 3mm x 3mm MLF <sup>®</sup>	Pb-Free

## Pin Configuration

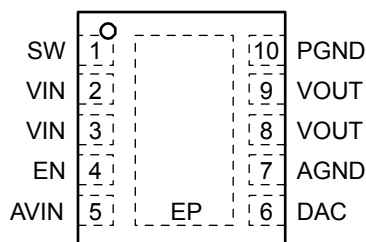

10-Pin MLF<sup>®</sup> (ML)

## Pin Description

Pin Number	Pin Name	Pin Function
1	SW	Switch (Output): Internal power MOSFET output switches.
2, 3	VIN	Supply Voltage (Input): Requires bypass capacitor to GND.
4	EN	A low level EN will power down the device, reducing the quiescent current to under 5 $\mu$ A (typ 1 $\mu$ A).
5	AVIN	Supply Voltage (Input): Requires bypass capacitor to GND.
6	DAC	DAC Control Input. Provides control of output voltage. The output voltage is 3 X the DAC voltage. (Ex. 0.5VDAC = 1.5V <sub>OUT</sub> ). Bypass mode is enabled when the DAC voltage exceeds 1.2V.
7	AGND	Signal Ground of chip.
8, 9	VOUT	Source of Internal P-Channel MOSFET and Feedback of internal PWM regulator.
10	PGND	Power Ground of chip.
EP	Exposed Pad	Connect to ground.

**Absolute Maximum Ratings<sup>(1)</sup>**

Supply Voltage ( $V_{IN}$ )	0V to 6V
Output Switch Voltage ( $V_{SW}$ )	6V
DAC Input Voltage ( $V_{DAC}$ )	0V to $V_{IN} + 0.3V$
Output Switch Current ( $I_{SW}$ )	2.5A
Logic Input Voltage ( $V_{EN}$ )	0V to $V_{IN} + 0.3V$
Storage Temperature ( $T_s$ )	-65°C to +150°C

**Operating Ratings<sup>(2)</sup>**

Supply voltage ( $V_{IN}$ )	2.7V to +5.5V
Output Voltage ( $V_{OUT}$ )	0V to 5.5V
DAC Input Voltage ( $V_{DAC}$ )	0.1V to $V_{IN}$
Junction Temperature ( $T_J$ )	-40°C to +125°C
Thermal Resistance MLF <sup>®</sup> -10 ( $\theta_{JA}$ )	60°C/W

**Electrical Characteristics<sup>(4)</sup>**

$V_{IN} = V_{EN} = 3.6V$ ;  $V_{DAC} = 0.6V$ ;  $L = 4.7\mu H$ ;  $C_{OUT} = 1\mu F$ ;  $T_A = 25^\circ C$ , **bold** values indicate  $-40^\circ C \leq T_J \leq +125^\circ C$ , unless noted.

Parameter	Condition	Min	Typ	Max	Units
Supply Voltage Range		<b>2.7</b>		<b>5.5</b>	V
Total Quiescent Current	$V_{DAC} = 0.6V$ $V_{OUT} = 2.4V$ (regulator on, not switching)		360	<b>450</b>	$\mu A$
Shutdown Current	$V_{EN} = 0V$ (regulator off)		1	<b>5</b>	$\mu A$
Maximum Duty Cycle		<b>100</b>			%
<b>Regulation</b>					
Output Voltage	$V_{DAC} = 0.6V$ , $I_{LOAD} = 0mA$	<b>1.746</b>	1.8	<b>1.854</b>	V
Output Voltage Line Regulation	$3.0V \leq V_{IN} \leq 4.5V$ , $I_{LOAD} = 10mA$		0.05	0.5	%/V
Output Voltage Load Regulation	$0mA < I_{OUT} < 500mA$		0.2		%
<b>Output</b>					
Switch On-Resistance	$I_{SW} = -100mA$ , High-Side Switch $I_{SW} = 100mA$ , Low-Side Switch		0.55 0.6	0.75 0.85	$\Omega$ $\Omega$
Current limit (Peak SW Current)		<b>0.65</b>	0.85	<b>1.6</b>	A
<b>Oscillator</b>					
Frequency		<b>1.8</b>	2	<b>2.2</b>	MHz
<b>Enable / UVLO</b>					
Enable Pin Threshold		<b>0.5</b>	0.9	<b>1.3</b>	V
Enable Pin Hysteresis			30		mV
Enable Pin Input Current			0.01	<b>1</b>	$\mu A$
EN high to 90% $V_{OUT}$			25	<b>50</b>	$\mu s$
Under-Voltage Lockout Threshold	(turn-on)		2.6	<b>2.7</b>	V
UVLO Hysteresis			85		mV
<b>DAC Input</b>					
DAC Input Current			0.15	<b>2</b>	$\mu A$
Output Voltage/DAC Voltage	(internally set)		3		V/V
<b>Bypass Switch</b>					
Bypass Switch Threshold		<b>1.176</b>	1.2	<b>1.224</b>	V
Bypass Switch Hysteresis			35		mV
Bypass Transition Time			10		$\mu s$
Bypass Switch On-Resistance			40		m $\Omega$
Bypass Switch Leakage				<b>5</b>	$\mu A$
Bypass Over-Current Limit		<b>1</b>	1.4	<b>2.5</b>	A
Current Limit Retry Time			32		$\mu s$
Current Limit Retry Duty Cycle			12.5		%

Parameter	Condition	Min	Typ	Max	Units
<b>Over Temperature Shutdown</b>					
Shutdown Temperature			160		°C
Over Temperature Shutdown Hysteresis			20		°C

**Notes:**

1. Exceeding the absolute maximum rating may damage the device.
2. The device is not guaranteed to function outside its operating rating.
3. Devices are ESD sensitive. Handling precautions recommended. Human body model, 1.5k in series with 100pF.
4. Specification for packaged product only.

# Typical Characteristics

**Efficiency 2.7V<sub>OUT</sub>**

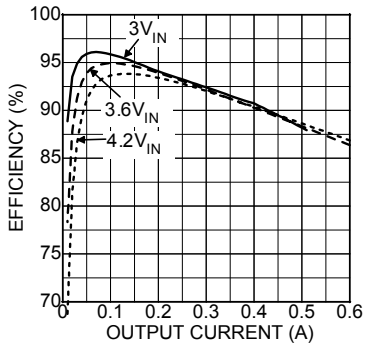

**Efficiency 1.8V<sub>OUT</sub>**

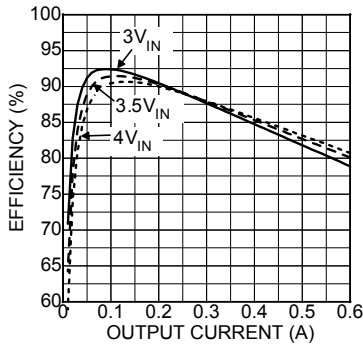

**Efficiency 1.5V<sub>OUT</sub>**

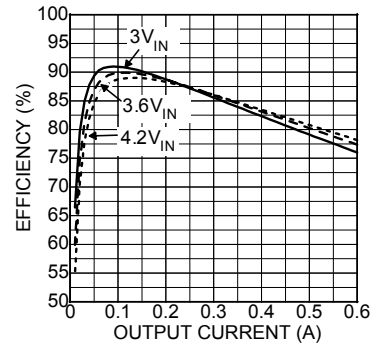

**Efficiency 1.2V<sub>OUT</sub>**

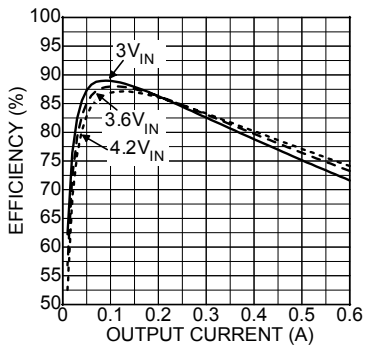

**Efficiency 0.9V<sub>OUT</sub>**

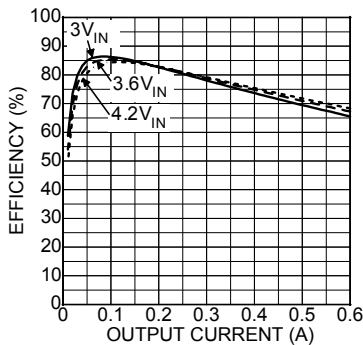

**Efficiency 0.6V<sub>OUT</sub>**

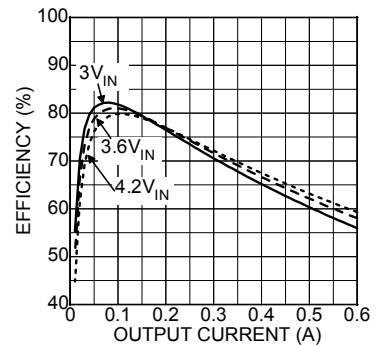

**Load Regulation**

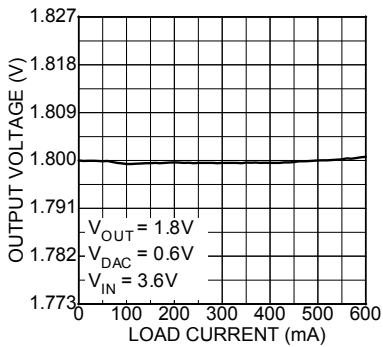

**Output Voltage vs. Temperature**

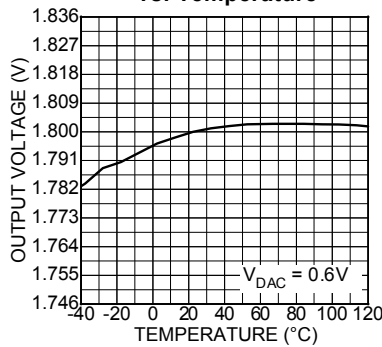

**V<sub>OUT</sub>/DAC vs. Temperature**

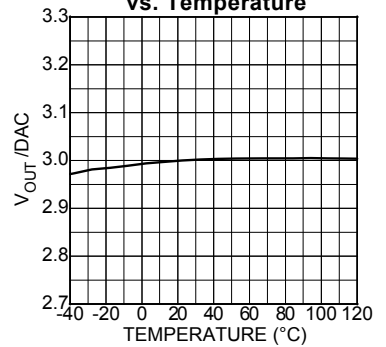

**Output Voltage vs. DAC Voltage**

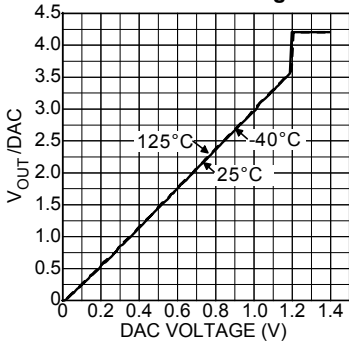

**Frequency vs. Temperature**

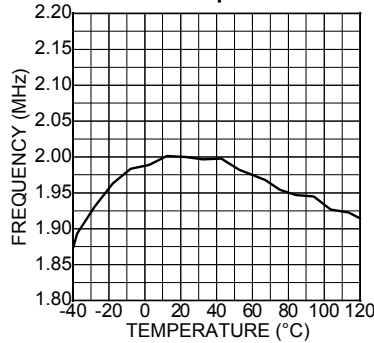

**Quiescent Current vs. Temperature**

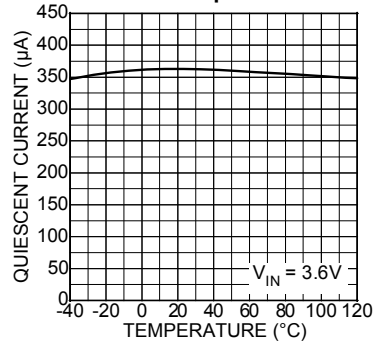

### Typical Characteristics (cont.)

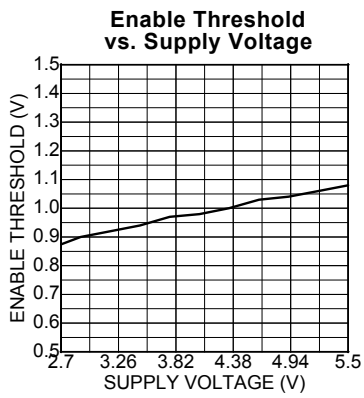
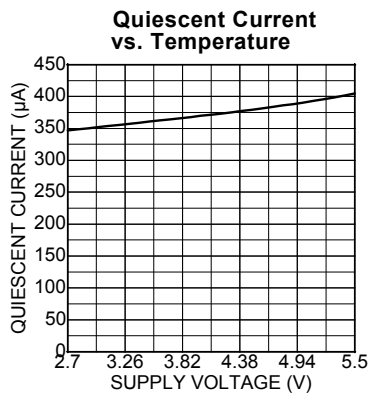

# Functional Characteristics

**Bypass Mode Transient**

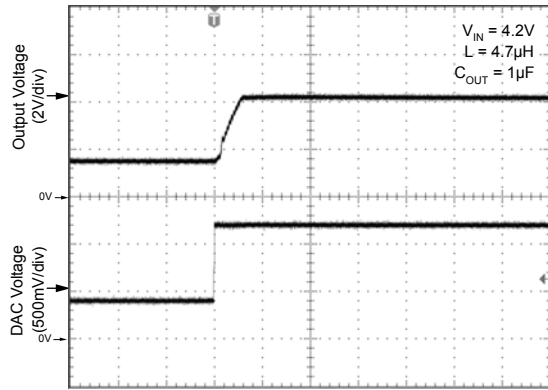

**Bypass Mode Transient**

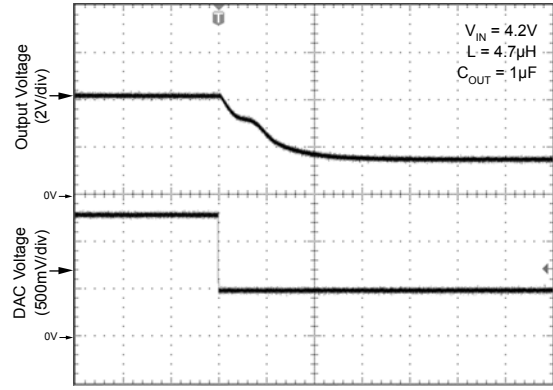

**Current Limit Transient (Bypass Mode)**

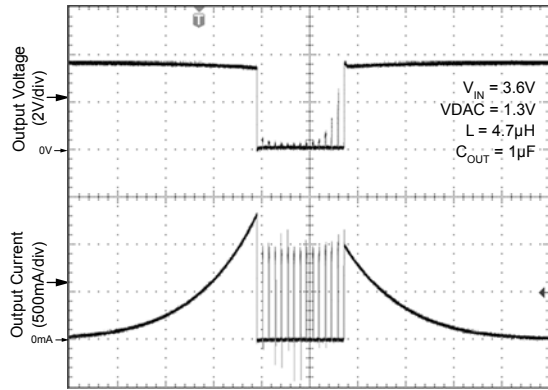

**Current Limit Transient (PWM Mode)**

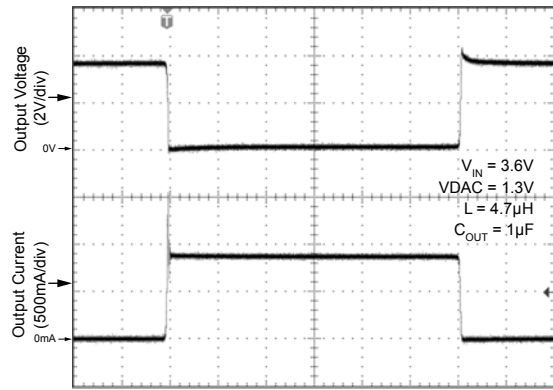

**Enable Transient**

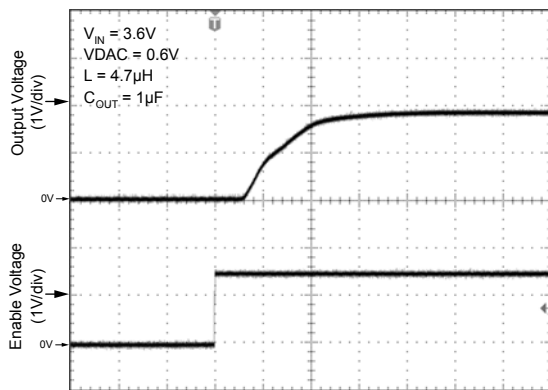

**Load Transient**

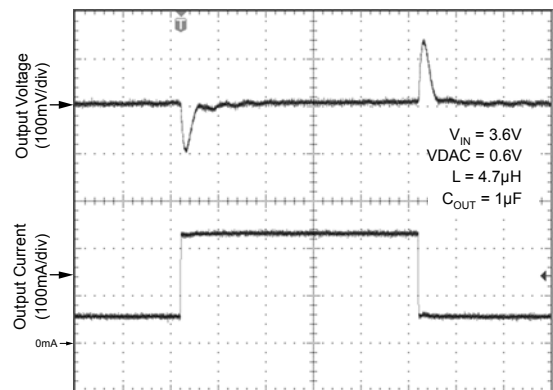

## Functional Characteristics (cont.)

Output Voltage Transient

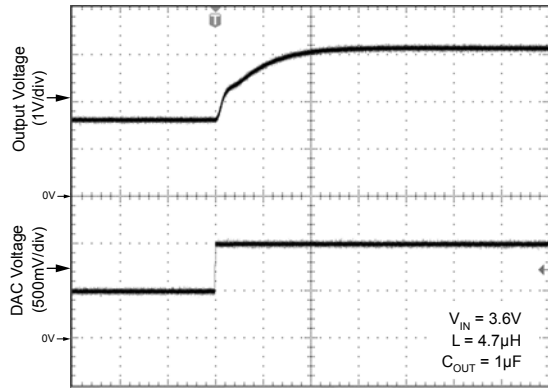

Time 10 $\mu s$

Output Voltage Transient

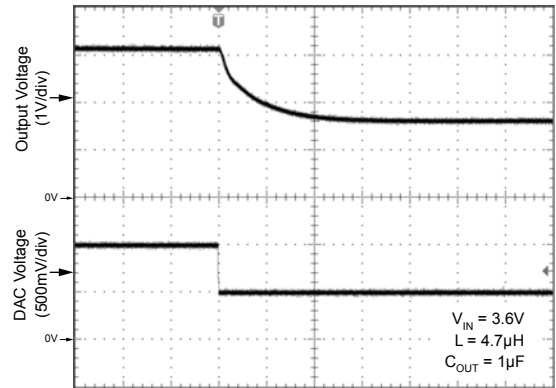

Time 10 $\mu s$

Switch Voltage - Output Ripple

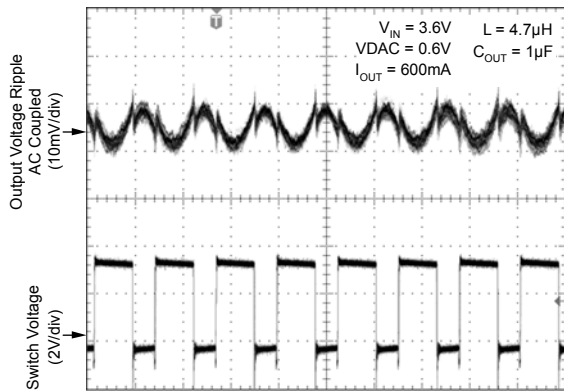

Time 400ns



# Functional Diagram

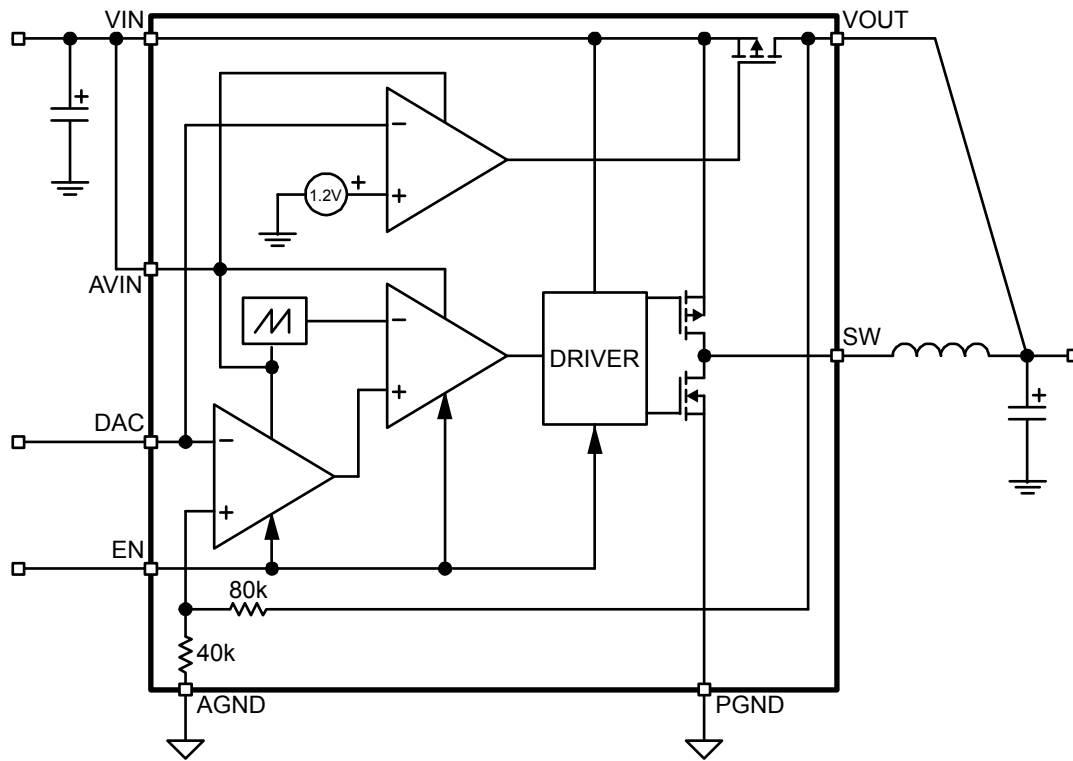

MIC2224 Block Diagram

## Functional Description

### VIN

VIN provides power to the MOSFETs for the switch mode regulator section, along with the current limiting sensing. Due to the high switching speeds, a 1 $\mu$ F capacitor is recommended close to VIN and the power ground (PGND) pin for bypassing.

### AVIN

Analog VIN (AVIN) provides power to the internal reference and control section. AVIN and VIN must be tied together. Careful layout should be considered to ensure high frequency switching noise caused by VIN is reduced before reaching AVIN.

### DAC

The DAC pin is the control pin that sets the output voltage. The Output voltage is 3X the voltage set on the DAC pin. When 1.2V or greater is applied to the DAC pin, the MIC2224 enters bypass mode. In bypass mode, the input supply is connected to the output through a 40m $\Omega$  P-Channel MOSFET.

### EN

The enable pin provides a logic level control of the output. In the off state, supply current of the device is greatly reduced (typically <1 $\mu$ A). Also, in the off state, the output drive and bypass switch are placed in a "tri-stated" condition, where both the high side P-channel Mosfet and the low-side N-channel are in an off or non-conducting state. Do not drive the enable pin above the supply voltage.

### VOUT

The VOUT pin connects the internal bypass drain and the feedback signal to the output. The bypass applies the input voltage through a low resistance (40m $\Omega$  typical) P-Channel MOSFET switch. The feedback signal provides the control path to set the output at 3X the DAC voltage.

### SW

The switch (SW) pin connects directly to the inductor and provides the switching current necessary to operate in PWM mode. Due to the high speed switching on this pin, the switch node should be routed away from sensitive nodes.

### PGND

Power ground (PGND) is the ground path for the high current PWM mode. The current loop for the power ground should be as small as possible and separate from the Analog ground (AGND) loop.

### AGND

Signal ground (AGND) is the ground path for the biasing and control circuitry. The current loop for the signal ground should be separate from the Power ground (PGND) loop.

## Application Information

The MIC2224 is a 600mA PWM power supply that utilizes a dynamically adjustable output voltage for powering RF power amplifiers. By dynamically adjusting the output power as necessary, battery life can be dramatically improved in battery powered RF applications. For instances where high power is required, the MIC2224 also has a bypass mode. Bypass mode is enabled by driving the DAC pin above 1.2V. This bypasses the input supply directly to the output through a highly efficient, short circuit protected, 40mΩ P channel MOSFET.

### Input Capacitor

A minimum 1μF ceramic is recommended on the VIN pin for bypassing. X5R or X7R dielectrics are recommended for the input capacitor. Y5V dielectrics lose most of their capacitance over temperature and are therefore not recommended. A minimum 1μF is recommended close to the VIN and PGND pins for high frequency filtering. Smaller case size capacitors are recommended due to their lower ESR and ESL.

### Output Capacitor

The MIC2224 is optimized for a 1μF ceramic output capacitor. The MIC2224 utilizes type III internal compensation and utilizes internal high frequency zeros to compensate for the double pole roll off of the LC filter. For this reason, larger output capacitors can create

instabilities. X5R or X7R dielectrics are recommended for the output capacitor. Y5V dielectrics lose most of their capacitance over temperature and are therefore not recommended. In addition to a 1μF, a small 10nF is recommended close to the load for high frequency filtering. Smaller case size capacitors are recommended due to their lower ESR and ESL.

### Inductor Selection

The MIC2224 is designed for use with a 4.7μH inductor. Proper selection should ensure the inductor can handle the maximum average and peak currents required by the load. Maximum current ratings of the inductor are generally given in two methods; permissible DC current and saturation current. Permissible DC current can be rated either for a 40°C temperature rise or a 10% to 20% loss in inductance. Ensure the inductor selected can handle the maximum operating current. When saturation current is specified, make sure that there is enough margin that the peak current will not saturate the inductor. Peak inductor current can be calculated as follows:

$$I_{PK} = I_{OUT} + \frac{V_{OUT} \left( 1 - \frac{V_{OUT}}{V_{IN}} \right)}{2 \times f \times L}$$

## Bill of Materials

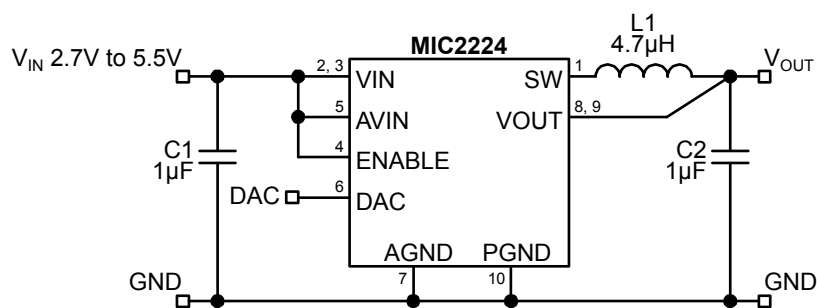

Item	Part Number	Manufacturer	Description	Qty.
C1, C2	06036D105MAT2	AVX <sup>(1)</sup>	1µF Ceramic Capacitor X5R, 6.3V 0603	2
	C1608X5R0J105K	TDK <sup>(2)</sup>		
	GRM185R60J105KE21D	Murata <sup>(3)</sup>		
L1	LQH32CN4R7M53K	Murata <sup>(3)</sup>	4.7µH 3.2mm x 2.5mm x 1.55mm	1
	CDRH2D14-4R7	Sumida <sup>(4)</sup>	4.7µH Inductor 94mΩ 3.2mm x 3.2mm x 1.55mm	
	GLF201208T4R7M*	TDK <sup>(2)</sup>	4.7µH Inductor 660mΩ	
U1	<b>MIC2224YML</b>	<b>Micrel<sup>(5)</sup></b>	<b>Micrel Data Sheet Title Here</b>	<b>1</b>

**Notes:**

1. AVX Tel: 843-448-9411
  2. TDK. Tel: 714-508-8800
  3. Murata Tel: 949-916-4000
  4. Sumida Tel: 408-982-9660
  5. Micrel Semiconductor Tel: 408-944-0800
- \* For maximum load currents less than 200mA

# Package Information

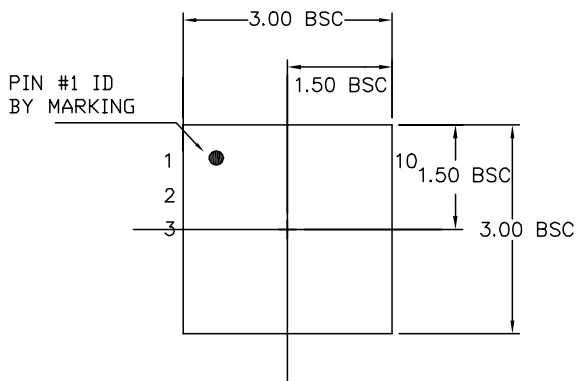

TOP VIEW

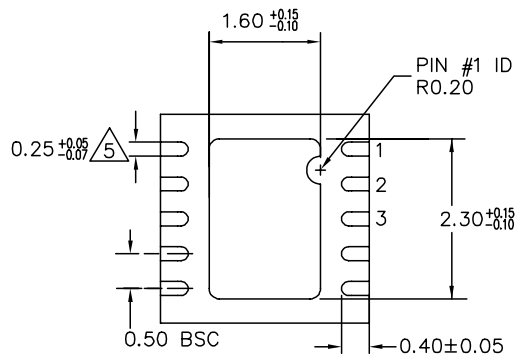

BOTTOM VIEW

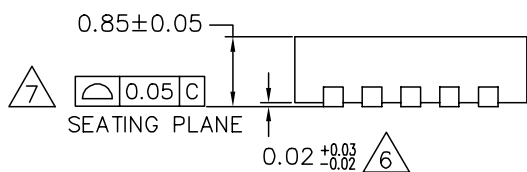

SIDE VIEW

NOTE:

1. ALL DIMENSIONS ARE IN MILLIMETERS.
2. MAX. PACKAGE WARPAGE IS 0.05 mm.
3. MAXIMUM ALLOWABLE BURRS IS 0.076 mm IN ALL DIRECTIONS.
4. PIN #1 ID ON TOP WILL BE LASER/INK MARKED.
5. DIMENSION APPLIES TO METALIZED TERMINAL AND IS MEASURED BETWEEN 0.20 AND 0.25 mm FROM TERMINAL TIP.
6. APPLIED ONLY FOR TERMINALS.
7. APPLIED FOR EXPOSED PAD AND TERMINALS.

## 10-Pin MLF® (ML)

**MICREL, INC. 2180 FORTUNE DRIVE SAN JOSE, CA 95131 USA**  
 TEL +1 (408) 944-0800 FAX +1 (408) 474-1000 WEB <http://www.micrel.com>

The information furnished by Micrel in this data sheet is believed to be accurate and reliable. However, no responsibility is assumed by Micrel for its use. Micrel reserves the right to change circuitry and specifications at any time without notification to the customer.

Micrel Products are not designed or authorized for use as components in life support appliances, devices or systems where malfunction of a product can reasonably be expected to result in personal injury. Life support devices or systems are devices or systems that (a) are intended for surgical implant into the body or (b) support or sustain life, and whose failure to perform can be reasonably expected to result in a significant injury to the user. A Purchaser's use or sale of Micrel Products for use in life support appliances, devices or systems is a Purchaser's own risk and Purchaser agrees to fully indemnify Micrel for any damages resulting from such use or sale.

© 2005 Micrel, Incorporated.

## X-ON Electronics

Largest Supplier of Electrical and Electronic Components

*Click to view similar products for [Voltage Regulators - Switching Regulators](#) category:*

*Click to view products by [Microchip](#) manufacturer:*

Other Similar products are found below :

[LX7186A](#) [622616F](#) [632259F](#) [MP2148GQD-33-P](#) [MP2374DS-LF-Z](#) [EN6310QA](#) [NCP81108MNTXG](#) [NCP81109BMNTXG](#) [L79M05TL-E](#)  
[FAN48610BUC45X](#) [R3](#) [LV5710GP-TE-L-H](#) [430464BB](#) [455605G](#) [MIC4930YFL-T5](#) [KE177614](#) [418569H](#) [455596X](#) [511087D](#) [030908C](#)  
[063375FB](#) [067501FB](#) [099508GB](#) [EP5358LUA](#) [NCP81102MNTXG](#) [715715H](#) [FAN48611UC53X](#) [FAN53611AUC12X](#) [MAX809TTR](#)  
[MAX77596ETBC+T](#) [MAX77596ETBB+T](#) [MAX16905AUE/V+](#) [NCP6332CMTAATBG](#) [NCV890203MWTXG](#) [LX7176A](#) [MP2162AGQH-Z](#)  
[MAX17544ATP+T](#) [MCP1623T-IMC](#) [MCP1642B-18IMC](#) [MCP1642BT-30I/MS](#) [MCP1642D-50IMC](#) [MCP1642D-50IMS](#) [MCP1642D-ADJIMC](#) [MC34063LBBGEVB](#) [MCP1252T-33X50IMS](#) [MCP1259-EMF](#) [MCP1602-250IMF](#) [MCP1640CT-IMC](#) [MCP1642B-30IMC](#)  
[MCP1642B-50IMC](#)