



MIC23603 Evaluation Board

4MHz PWM 6A Buck Regulator with
Hyper Light Load[®]

General Description

The MIC23603 evaluation board allows the customer to evaluate the MIC23603, a fully-integrated 6A, 4MHz switching regulator that features Hyper Light Load[®] mode, a power good output indicator, and programmable soft-start. The MIC23603 is highly efficient throughout the output current range, drawing just 24 μ A of quiescent current in operation. The tiny 4mm \times 5mm DFN package saves precious board space and requires few external components. The MIC23603 provides accurate output voltage regulation under the most demanding conditions and responds extremely quickly to a load transient with exceptionally small output voltage ripple.

Requirements

The MIC23603 evaluation board requires a single 40W bench power source adjustable from 2.7V to 5.5V. The loads can be either active (electronic load) or passive (resistor), and must be able to dissipate 30W. It is ideal, but not essential, to have an oscilloscope available to view the circuit waveforms. The simplest tests require two voltage meters to measure input and output voltage. Efficiency measurements require two voltage meters and two ammeters to prevent errors caused by measurement inaccuracies.

Precautions

There is no reverse input protection on this board. Be careful when connecting the input source to make sure correct polarity is observed.

Datasheets and support documentation are available on Micrel's web site at: www.micrel.com.

Getting Started

1. Connect an external supply to the V_{IN} (J1) terminal and GND (J2).

With the output of the power supply disabled, set its voltage to the desired input test voltage ($2.7V \leq V_{IN} \leq 5.5V$). An ammeter may be placed between the input supply and the V_{IN} (J1) terminal. Be sure to monitor the supply voltage at the V_{IN} (J1) terminal, as the ammeter and/or power lead resistance can reduce the voltage supplied to the device.

2. Connect a load to the V_{OUT} (J4) and ground (J3) terminals.

The load can be either active passive (resistive) or active (electronic load). An ammeter may be placed between the load and the output terminal. Make sure the output voltage is monitored at the V_{OUT} (J4) terminal. The board has a 2-pin connector (TP1) to allow for output voltage monitoring.

3. Enable the MIC23603.

The MIC23603 evaluation board has a pull-up resistor to V_{IN} . By default, the output voltage is enabled when the input supply of $>2.7V$ is applied. To disable the device, apply a voltage below 0.4V to the EN (J6) terminal.

4. Power Good.

The board provides a power good test point (J5) to monitor the power good function. The power good output goes high (V_{OUT}) approximately 40 μ s after the output voltage reaches 90% of its nominal voltage.

Ordering Information

Part Number	Description
MIC23603YML EV	Adjustable Output Evaluation Board

Hyper Light Load is a registered trademark of Micrel, Inc.

Micrel Inc. • 2180 Fortune Drive • San Jose, CA 95131 • USA • tel +1 (408) 944-0800 • fax + 1 (408) 474-1000 • <http://www.micrel.com>

Evaluation Board

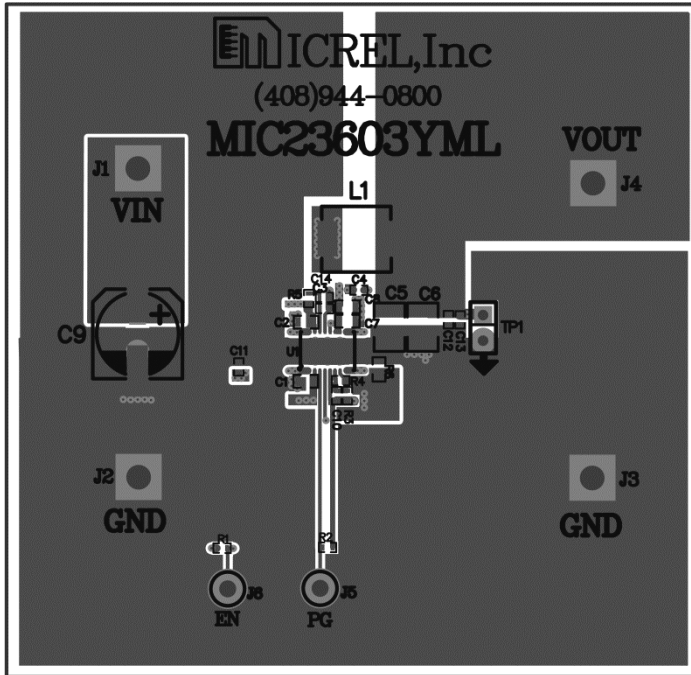

Figure 1. MIC23603 Evaluation Board – Top Layer

Other Features

Soft-Start Capacitor

The soft-start (SS) pin is used to control the output voltage ramp-up time. Setting C4 to 2.2nF sets the start-up time to the minimum. The start-up time can be determined by:

$$T_{SS} = 250 \times 10^3 \times \ln(10) \times C_{SS} \quad \text{Eq. 1}$$

The soft-start capacitor controls the rise time of the internal reference voltage between 0% and 100% of its nominal steady state value.

Feedback Resistors (R3, R4) for Adjustable Output

The output voltage is set nominally to 1.8V. This output can be changed by adjusting the upper resistor, R3, in the feedback potential divider. Therefore:

$$R3 = R4 \times (V_O - V_{REF})/V_{REF} \quad \text{Eq. 2}$$

where $V_{REF} = 0.62V$.

Examples of values are illustrated in Table 1.

Table 1. Example Values for V_{OUT} , R3, and R4

V_{OUT}	R3	R4
1.2V	274k Ω	294k Ω
1.5V	316k Ω	221k Ω
1.8V	560k Ω	294k Ω
2.5V	324k Ω	107k Ω
3.3V	464k Ω	107k Ω

The feed-forward capacitor, C10, can be fitted to improve transient performance. This improves transients by injecting fast output voltage deviations directly into the feedback comparator. This improved load regulation is at the expense of slightly increasing the amount of noise on the output at higher loads. A typical value range of 33pF to 68pF is recommended.

Power Good (PG)

The evaluation board has a test point provided to the right of EN for testing PG. This is an open-drain connection to the output voltage with an on-board pull-up resistor of 100k Ω . This is asserted high approximately 40 μ s after the output voltage passes 90% of the nominal set voltage.

Hyper Light Load Mode

MIC23603 uses a minimum on and off time proprietary control loop (patented by Micrel). When the output voltage falls below the regulation threshold, the error comparator begins a switching cycle that turns the PMOS on and keeps it on for the duration of the minimum-on-time. This increases the output voltage. If the output voltage is over the regulation threshold, then the error comparator turns the PMOS off for a minimum-off-time until the output drops below the threshold. The NMOS acts as an ideal rectifier that conducts when the PMOS is off. Using an NMOS switch instead of a diode allows for lower voltage drop across the switching device when it is on. The asynchronous switching combination between the PMOS and the NMOS allows the control loop to work in discontinuous mode for light load operations. In discontinuous mode, the MIC23603 works in pulse frequency modulation (PFM) to regulate the output. As the output current increases, the off-time decreases, which provides more energy to the output. This switching scheme improves the efficiency of MIC23603 during light load currents by switching only when it is needed. As the load current increases, the MIC23603 goes into continuous conduction mode (CCM) and switches at a frequency centered at 4MHz.

Refer to Equation 3 to calculate the load when the MIC23603 goes into continuous conduction mode:

$$I_{\text{LOAD}} > \left(\frac{V_{\text{IN}} - V_{\text{OUT}} \times D}{2L \times f} \right) \quad \text{Eq. 3}$$

Equation 3 illustrates that the load at which MIC23603 transitions from Hyper Light Load mode to PWM mode is a function of the input voltage (V_{IN}), output voltage (V_{OUT}), duty cycle (D), inductance (L), and frequency (f). The “Switching Frequency vs. Load” graph (see [Evaluation Board Performance](#) section) shows that, as the output current increases, the switching frequency also increases until the MIC23603 goes from Hyper Light Load mode to PWM mode at approximately 300mA. The MIC23603 will switch at a relatively constant frequency around 4MHz after the output current is over 300mA.

Evaluation Board Performance

Switching Frequency Vs Load Current

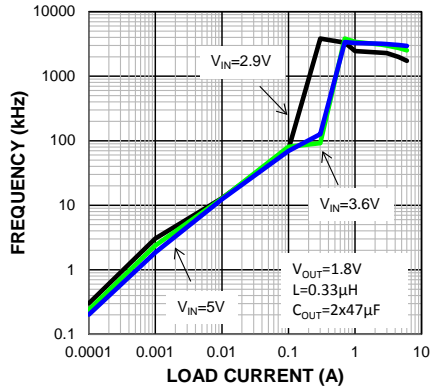

Efficiency Vs. Output Current

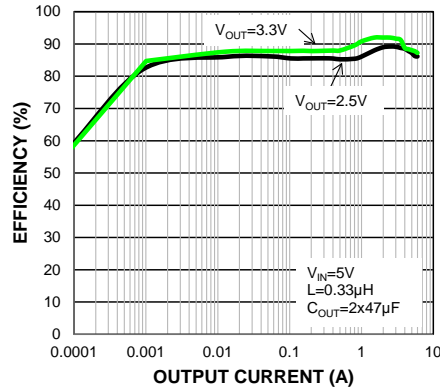

Efficiency vs. Load 1.8vout

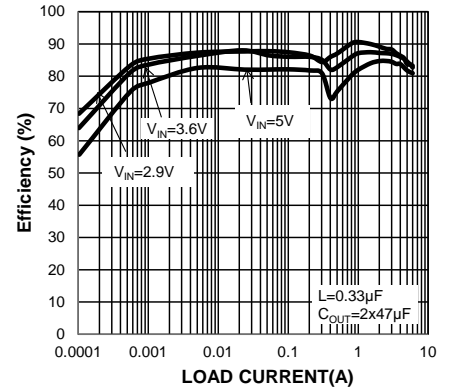

VOUT Rise Time vs C_{SS}

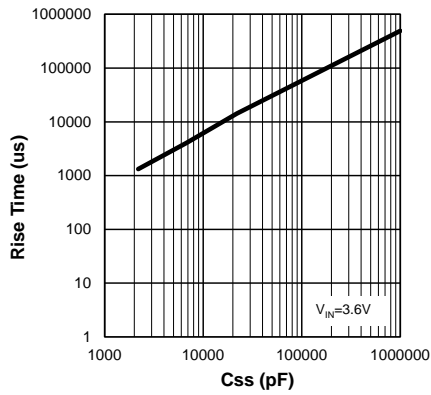

Enable Thresholds Vs. Input Voltage

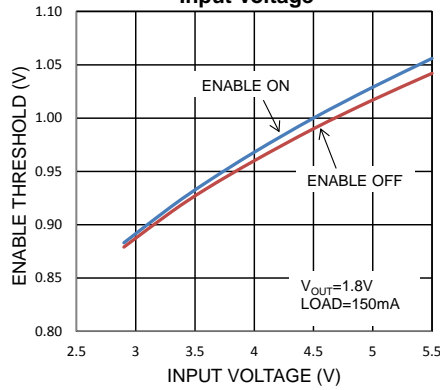

Evaluation Board Schematic

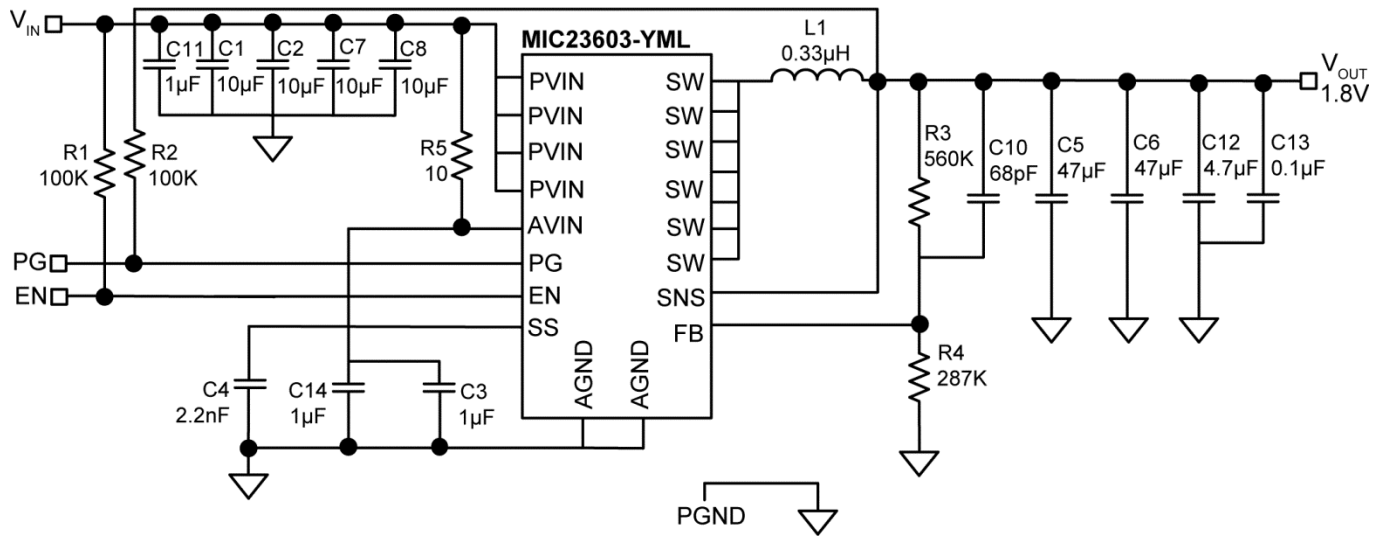

Bill of Materials

Item	Part Number	Manufacturer	Description	Qty.
C1, C2, C7, C8	06036D106MAT2A	AVX ⁽¹⁾	10μF/6.3V, X5R, 0603	4
	GRM188R60J106ME47D	Murata ⁽²⁾		
	C1608X5R0J106M	TDK ⁽³⁾		
C3, C11, C14	04026D105KAT2A	AVX	1μF/6.3V, X5R, 0402	4
	GRM155R60J105KE19D	Murata		
	C1005X5R0J105K	TDK		
C4	04025A223JAT2A	AVX	2.2nF/50V, 0402	1
	GRM1555C1H223JA01D	Murata		
	C1005C0G1H223J	TDK		
C5,C6	12066D476MAT2A	AVX	47μF/6.3V, X5R,1206	2
	C3216X6S1A476M	TDK		
	GRM31CR60J476ME19L	Murata		
C9	ECA-1AHG221	Panasonic ⁽⁴⁾	Capacitor, Alum, 220μF, 10V, 20% Radial	1
C10	04025A680JAT2A	AVX	68pF, 50V, NPO,0402	1
	C1005C0G1H680J	TDK		
	GRM1555C1H680JZ01D	Murata		
C12	GRM155R60J475ME47D	Murata	4.7μF, 6.3V, X5R, 0402	1
	04026D475KAT2A	AVX		
C13	04026C104KAT2A	AVX	0.1μF/6.3V, X7R, 0402	1
	C1005X7R0J104K	TDK		
	GRM155R70J104KA01D	Murata		
L1	IHLP2020CZERR33M01	Vishay ⁽⁵⁾	0.33μH, 13.7A , 4.3mΩ	1
	CDMC6D28NP-R30MC	Sumida ⁽⁶⁾	0.3μH, 16.1A, 2.7mΩ	
R1, R2	CRCW0402100KFKED	Vishay/Dale	100KΩ, 1%, 1/16W, 0402	2
R3	CRCW0402560KFKEA	Vishay/Dale	560KΩ, 1%, 1/6W, 0402	1
R4	CRCW0402294KFKEA	Vishay/Dale	294KΩ, 1%, 1/10W, 0402	1
R5	CRCW040210R0FKED	Vishay/Dale	10Ω, 1%, 1/16W, 0402	1
R6		Vishay/Dale	3Ω, 1%, 1/10W, 0603	1
U1	MIC23603YML	Micrel, Inc. ⁽⁷⁾	4MHz PWM 6A Buck Regulator with Hyper Light Load	1

Notes:

1. AVX: www.avx.com.
2. Murata: www.murata.com.
3. TDK: www.tdk.com.
4. Panasonic: www.panasonic.com.
5. Vishay: www.vishay.com.
6. Sumida: www.sumida.com.
7. Micrel, Inc.: www.micrel.com.

PCB Layout Recommendations

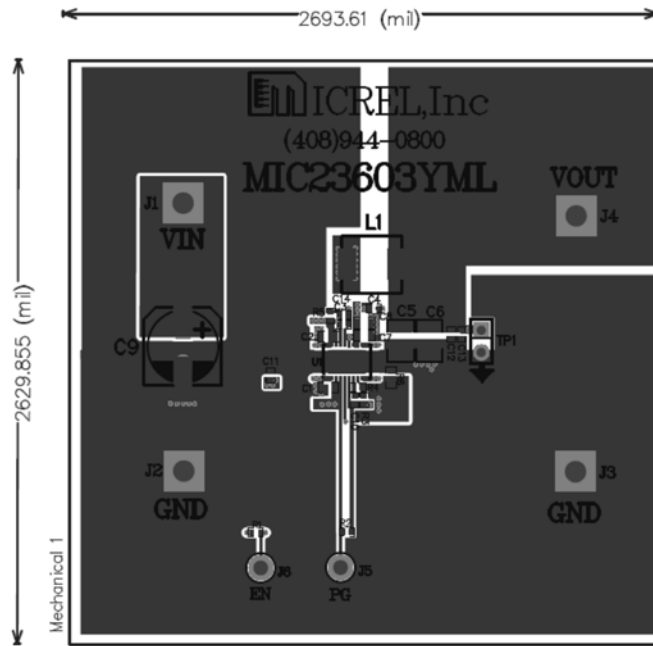

Top Layer

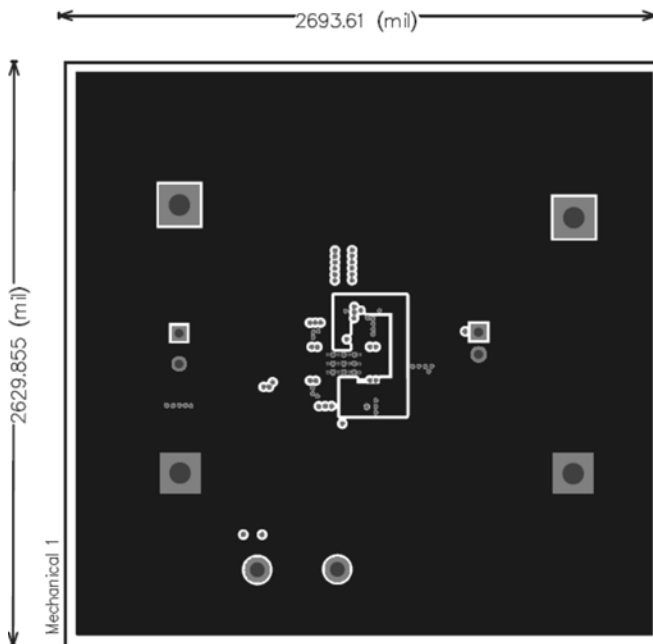

Layer 2

PCB Layout Recommendations (Continued)

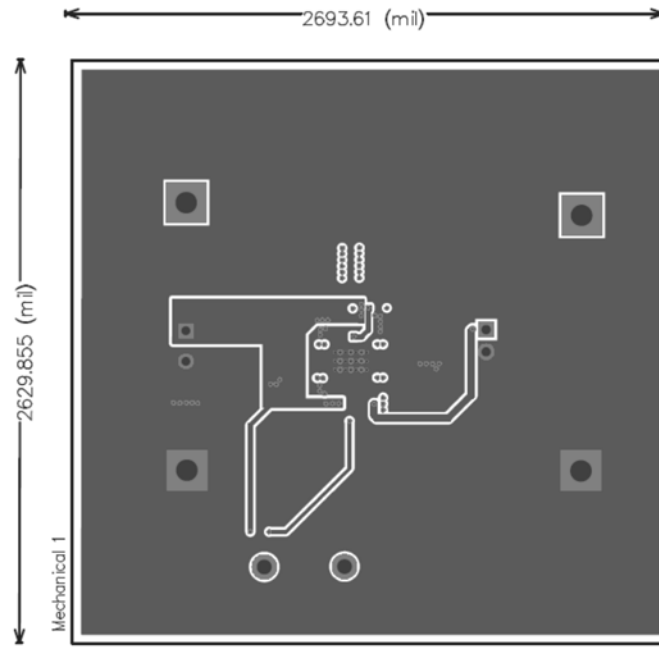

Layer 3

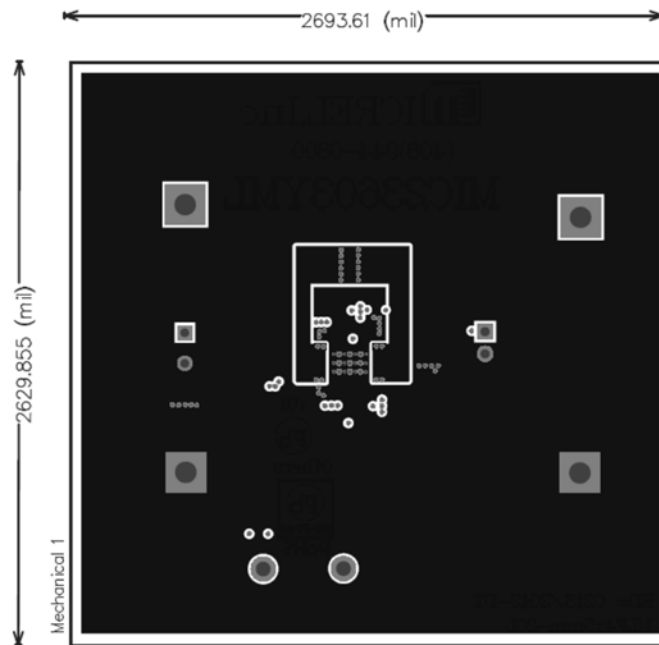

Bottom Layer

MICREL, INC. 2180 FORTUNE DRIVE SAN JOSE, CA 95131 USATEL +1 (408) 944-0800 FAX +1 (408) 474-1000 WEB <http://www.micrel.com>

Micrel, Inc. is a leading global manufacturer of IC solutions for the worldwide high performance linear and power, LAN, and timing & communications markets. The Company's products include advanced mixed-signal, analog & power semiconductors; high-performance communication, clock management, MEMs-based clock oscillators & crystal-less clock generators, Ethernet switches, and physical layer transceiver ICs. Company customers include leading manufacturers of enterprise, consumer, industrial, mobile, telecommunications, automotive, and computer products. Corporation headquarters and state-of-the-art wafer fabrication facilities are located in San Jose, CA, with regional sales and support offices and advanced technology design centers situated throughout the Americas, Europe, and Asia. Additionally, the Company maintains an extensive network of distributors and reps worldwide.

Micrel makes no representations or warranties with respect to the accuracy or completeness of the information furnished in this datasheet. This information is not intended as a warranty and Micrel does not assume responsibility for its use. Micrel reserves the right to change circuitry, specifications and descriptions at any time without notice. No license, whether express, implied, arising by estoppel or otherwise, to any intellectual property rights is granted by this document. Except as provided in Micrel's terms and conditions of sale for such products, Micrel assumes no liability whatsoever, and Micrel disclaims any express or implied warranty relating to the sale and/or use of Micrel products including liability or warranties relating to fitness for a particular purpose, merchantability, or infringement of any patent, copyright, or other intellectual property right.

Micrel Products are not designed or authorized for use as components in life support appliances, devices or systems where malfunction of a product can reasonably be expected to result in personal injury. Life support devices or systems are devices or systems that (a) are intended for surgical implant into the body or (b) support or sustain life, and whose failure to perform can be reasonably expected to result in a significant injury to the user. A Purchaser's use or sale of Micrel Products for use in life support appliances, devices or systems is a Purchaser's own risk and Purchaser agrees to fully indemnify Micrel for any damages resulting from such use or sale."

© 2014 Micrel, Incorporated.

X-ON Electronics

Largest Supplier of Electrical and Electronic Components

Click to view similar products for [Power Management IC Development Tools](#) category:

Click to view products by [Microchip](#) manufacturer:

Other Similar products are found below :

[EVAL6482H-DISC](#) [EVAL-AD5522EBUZ](#) [EVAL-ADM1060EBZ](#) [EVAL-ADM1073MEBZ](#) [EVAL-ADM1166TQEBZ](#) [EVAL-ADM1168LQEBZ](#) [EVAL-ADM1171EBZ](#) [EVAL-ADM1276EBZ](#) [EVB-EN5319QI](#) [EVB-EN5365QI](#) [EVB-EN6347QI](#) [EVB-EP5348UI](#) [MIC23158YML EV](#) [MIC23451-AAAYFL EV](#) [MIC5281YMME EV](#) [124352-HMC860LP3E](#) [ADM00513](#) [ADM8611-EVALZ](#) [ADM8612-EVALZ](#) [ADM8613-EVALZ](#) [ADP1046ADC1-EVALZ](#) [ADP1055-EVALZ](#) [ADP122-3.3-EVALZ](#) [ADP130-0.8-EVALZ](#) [ADP130-1.2-EVALZ](#) [ADP130-1.5-EVALZ](#) [ADP130-1.8-EVALZ](#) [ADP160UJZ-REDYKIT](#) [ADP166UJ-EVALZ](#) [ADP1712-3.3-EVALZ](#) [ADP1714-3.3-EVALZ](#) [ADP1715-3.3-EVALZ](#) [ADP1716-2.5-EVALZ](#) [ADP1740-1.5-EVALZ](#) [ADP1752-1.5-EVALZ](#) [ADP1754-1.5-EVALZ](#) [ADP1828LC-EVALZ](#) [ADP1870-0.3-EVALZ](#) [ADP1871-0.6-EVALZ](#) [ADP1873-0.6-EVALZ](#) [ADP1874-0.3-EVALZ](#) [ADP1876-EVALZ](#) [ADP1879-1.0-EVALZ](#) [ADP1882-1.0-EVALZ](#) [ADP1883-0.6-EVALZ](#) [ADP197CB-EVALZ](#) [ADP199CB-EVALZ](#) [ADP2102-1.25-EVALZ](#) [ADP2102-1.2-EVALZ](#) [ADP2102-1.875EVALZ](#)