



MIC24054 Evaluation Board

9A, High-Efficiency, Synchronous DC/DC Buck Regulator with HyperLight Load[®]

SuperSwitcher II[™]

General Description

The MIC24054 DC/DC synchronous buck regulator operates over an input supply range of 4.5V to 19V and provides a regulated output at up to 9A of load current. The output voltage is adjustable down to 0.8V with a typical accuracy of $\pm 1\%$.

Micrel's HyperLight Load[®] architecture maintains high efficiency under light load conditions by transitioning to variable frequency, discontinuous mode operation. The Hyper Speed Control[™] allows smaller output capacitance. The device operates at a switching frequency of 600kHz, which remains relatively constant with changes in input voltage and output load.

The MIC24054 uses an adaptive T_{ON} ripple control architecture. An undervoltage lockout feature is provided to ensure proper operation under power-sag conditions. An internal soft-start feature is provided to reduce the inrush current. Foldback current limit and "hiccup" mode short-circuit protection, and thermal shutdown ensures protection of the IC during fault conditions.

The HyperLight Load and Hyper Speed Control features allow ideal transition from light load to full load and vice versa. The 19V operating rating of the device provides ample design safety margin for 12V input applications.

The basic parameters of the MIC24051 evaluation board are a VIN supply of 5V to 19V, output voltage of 0.8V to 5V at 6A⁽¹⁾, and 600kHz switching frequency.

Note:

1. Refer to the temperature curves shown in [Evaluation Board Performance](#). The typical minimum input voltage to maximum output voltage conversion is limited by the maximum duty cycle.

Datasheets and support documentation are available on Micrel's web site at: www.micrel.com.

Requirements

The MIC24054 evaluation board requires only a single power supply with at least 10A current capability. The MIC24054 has internal VDD LDO so no external linear regulator is required to power the internal biasing of the IC. When $V_{IN} < 5.5V$, VDD should be tied to PVIN pins to bypass the internal linear regulator by a jumper. The output load can be either active or passive.

HyperLight Load is a registered trademark of Micrel, Inc.

Hyper Speed Control, SuperSwitcher II, and Any Capacitor are trademarks of Micrel, Inc.

Micrel Inc. • 2180 Fortune Drive • San Jose, CA 95131 • USA • tel +1 (408) 944-0800 • fax + 1 (408) 474-1000 • <http://www.micrel.com>

February 11, 2013

Revision 1.1

Power-Up Precautions

The evaluation board does not have reverse polarity protection. Applying a negative voltage to the VIN terminal may damage the device. The maximum VIN operating voltage of the MIC24054 evaluation board is 19V. The evaluation board has two different layout designs, one optimized for evaluation ([Figure 1](#)) and another one optimized for smaller footprint ([Figure 2](#)). The evaluation board is only populated with components shown in schematic [Figure 1](#).

Getting Started

1. VIN Supply.

Connect a supply to the VIN and GND terminals, paying careful attention to the polarity and the supply range ($5V < V_{IN} < 19V$). An ammeter may be placed between the input supply and the VIN terminal to the evaluation board. Make sure that the supply voltage is monitored at the VIN terminal. The ammeter and/or power lead resistance can reduce the voltage supplied to the input. Do not apply power until Step 4.

2. Connect the load to the V_{OUT} and ground terminals.

The load can be either passive (resistive) or active (as in an electronic load). An ammeter can be placed between the load and the V_{OUT} terminal. Make sure that the output voltage is monitored at the V_{OUT} terminal.

3. Enable Input.

An EN connector is provided on the evaluation board so that users can easily access the enable feature. The output of the MIC24054 turns on when VDD exceeds the UVLO threshold. The output of the MIC24054 may be turned off by shorting the EN pin to ground.

4. Turn on the Power.

Turn on VIN power supply and verify that the output voltage is regulated to 1.8V.

Ordering Information

Part Number	Description
MIC24054YJL EV	9A HLL DC/DC Buck Regulator Evaluation Board

Output Voltage

The output voltage on the MIC24054 evaluation board is adjustable. It is set by adjusting the feedback resistors, as shown in Equation 1:

$$V_{\text{OUT}} = V_{\text{FB}} \times \left(1 + \frac{R4}{R_{\text{BOTTOM}}} \right) \quad \text{Eq. 1}$$

where $V_{\text{FB}} = 0.8\text{V}$ and R_{BOTTOM} is one of the R5, R6, R7, R8, R9, R10, R11, R12, which corresponds to 0.9V, 1.0V, 1.2V, 1.5V, 1.8V, 2.5V, 3.3V, or 5V, respectively. Leaving R_{BOTTOM} open gives a 0.8V output voltage. The output voltage is set at the factory for a 1.8V output, but it can easily be changed by moving the jumper to the corresponding position to get an indicated voltage on the board. If a desired voltage is not shown on the board, it is easily changed by removing R_{BOTTOM} and replacing it with the values that yield the desired output voltage. After R4 is selected, R_{BOTTOM} can be calculated using Equation 2.

$$R_{\text{BOTTOM}} = \frac{R4 \times V_{\text{FB}}}{V_{\text{OUT}} - V_{\text{FB}}} \quad \text{Eq. 2}$$

For $V_{\text{FB}} = 0.8\text{V}$:

$$R_{\text{BOTTOM}} = \frac{R4 \times 0.8\text{V}}{V_{\text{OUT}} - 0.8\text{V}} \quad \text{Eq. 3}$$

Do not set the output voltage to exceed 5V because of the 6.3V rating of the output capacitor and the limitation of the line regulation. Please refer to the "Setting Output Voltage" and "Ripple Injection" subsections of the "Application Information" section of the MIC24054 datasheet for detailed information.

Evaluation Board Performance

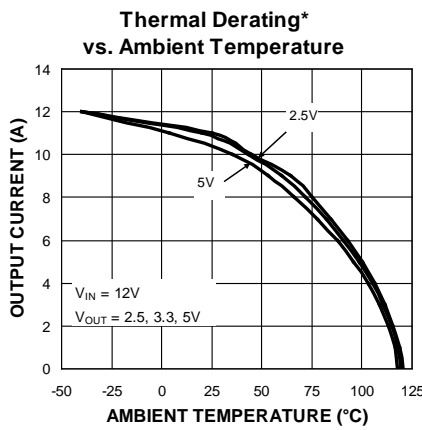
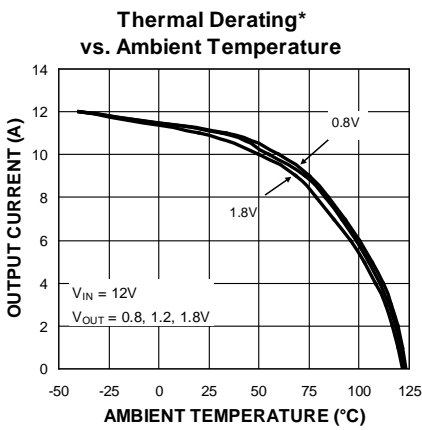
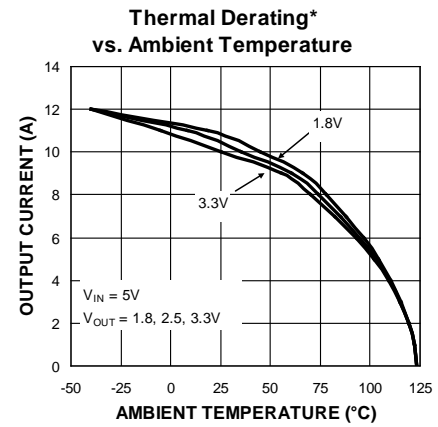
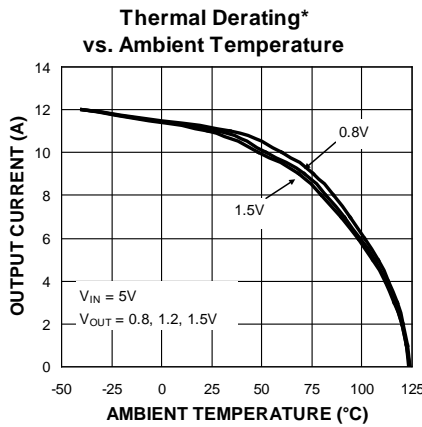
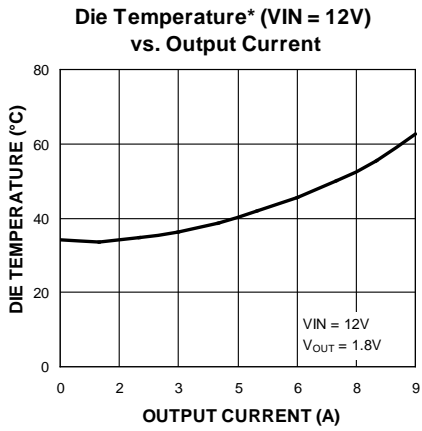
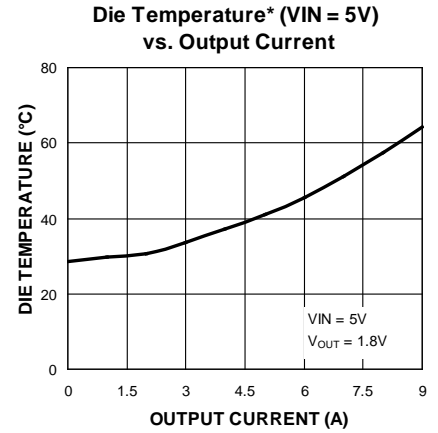
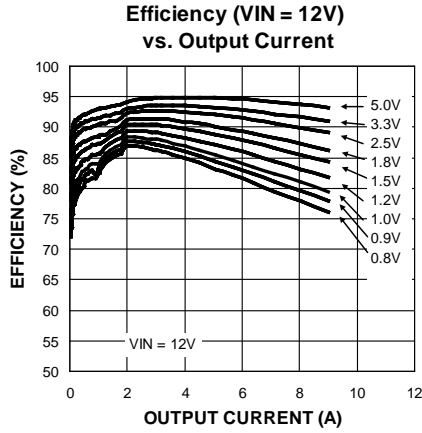
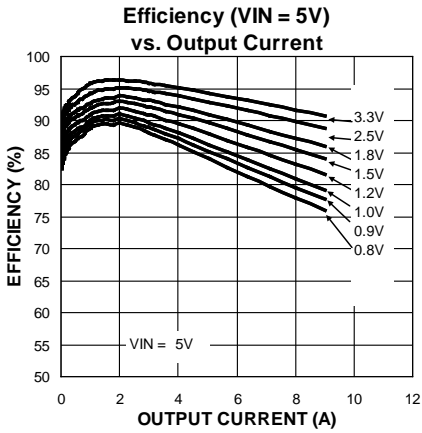

Die Temperature* : The temperature measurement was taken at the hottest point on the MIC24054, which was case mounted on a 5 square inch, 4 layer, 0.62", FR-4 PCB with 2oz finish copper weight per layer, see the *Thermal Measurement* section of the MIC24054 datasheet. Actual results will depend upon the size of the PCB, ambient temperature and proximity to other heat emitting components.

Evaluation Board Schematic

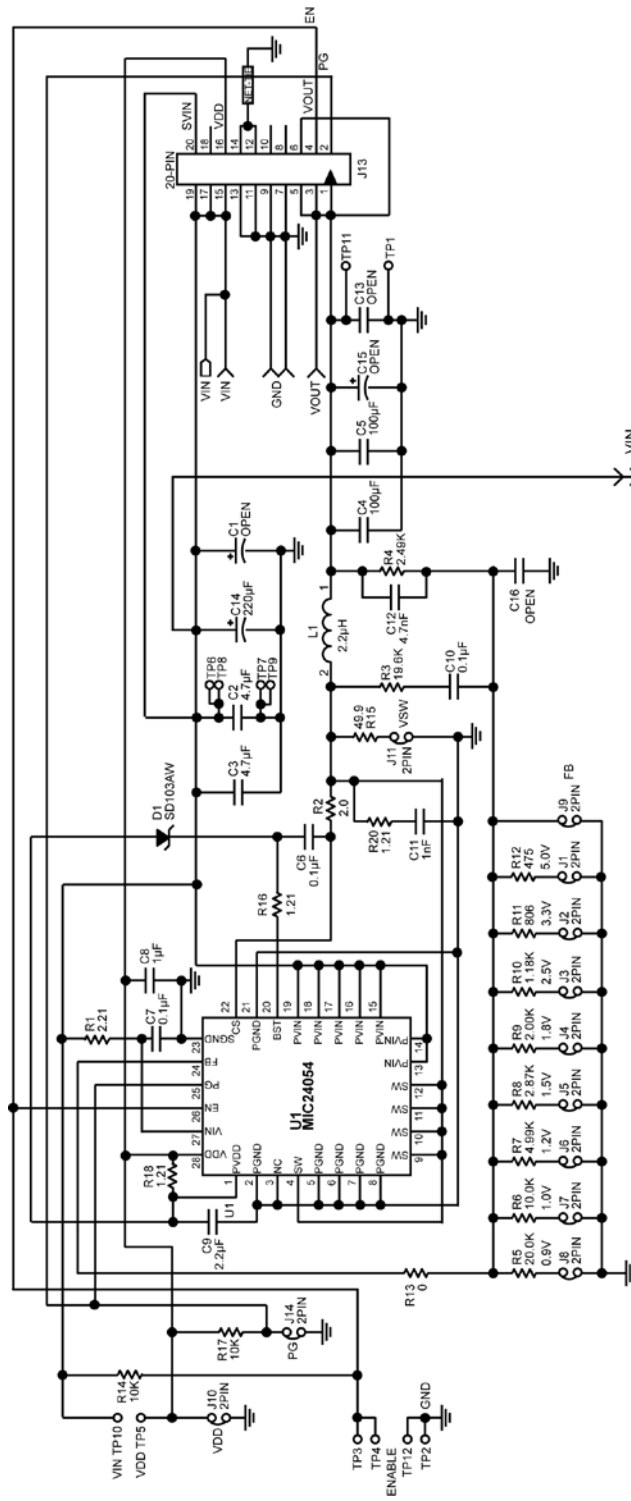

Figure 1. Schematic of MIC24054 Evaluation Board (J11, R13, R15 are for testing purposes)

Evaluation Board Schematic (Continued)

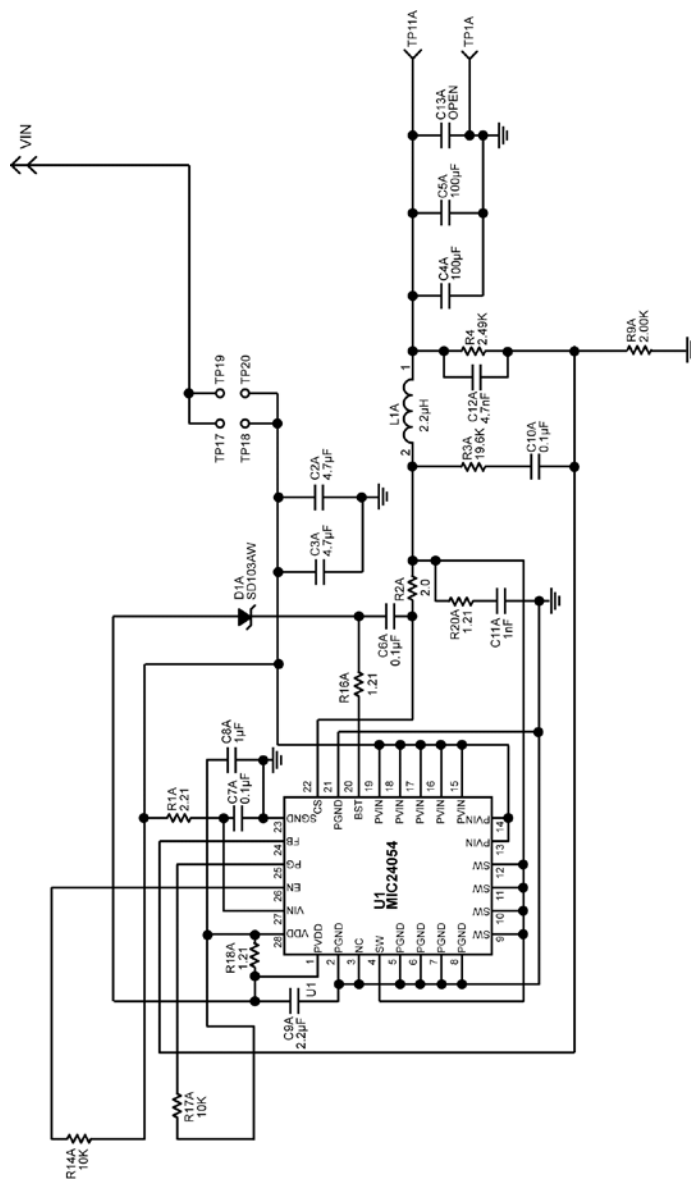

Figure 2. Schematic of MIC24054 Evaluation Board – Optimized for Smaller Footprint (J11, R13, R15 are for testing purposes)

Bill of Materials

Item	Part Number	Manufacturer	Description	Qty.
C1	Open			
C2, C3	12103C475KAT2A	AVX ⁽¹⁾	4.7 μ F Ceramic Capacitor, X7R, Size 1210, 25V	2
	GRM32DR71E475KA61K	Murata ⁽²⁾		
	C3225X7R1E475K	TDK ⁽³⁾		
C13, C15	Open			
C4, C5	12106D107MAT2A	AVX	100 μ F Ceramic Capacitor, X5R, Size 1210, 6.3V	2
	GRM32ER60J107ME20L	Murata		
	C3225X5R0J107M	TDK		
C6, C7, C10	06035C104KAT2A	AVX	0.1 μ F Ceramic Capacitor, X7R, Size 0603, 50V	3
	GRM188R71H104KA93D	Murata		
	C1608X7R1H104K	TDK		
C8	0603ZC105KAT2A	AVX	1.0 μ F Ceramic Capacitor, X7R, Size 0603, 10V	1
	GRM188R71A105KA61D	Murata		
	C1608X7R1A105K	TDK		
C9	0603ZD225KAT2A	AVX	2.2 μ F Ceramic Capacitor, X5R, Size 0603, 10V	1
	GRM188R61A225KE34D	Murata		
	C1608X5R1A225K	TDK		
C12	06035C472KAZ2A	AVX	4.7nF Ceramic Capacitor, X7R, Size 0603, 50V	1
	GRM188R71H472K	Murata		
	C1608X7R1H472K	TDK		
C14	B41851F7227M	EPCOS ⁽⁴⁾	220 μ F Aluminum Capacitor, 35V	1
C11, C16	Open			
D1	SD103AWS	MCC ⁽⁵⁾	40V, 350mA, Schottky Diode, SOD323	1
	SD103AWS-7	Diodes Inc. ⁽⁶⁾		
	SD103AWS	Vishay ⁽⁷⁾		
L1	HCF1305-2R2-R	Cooper Bussmann ⁽⁸⁾	2.2 μ H Inductor, 15A Saturation Current	1
R1	CRCW06032R21FKEA	Vishay Dale	2.21 Ω Resistor, Size 0603, 1%	1
R2	CRCW06032R00FKEA	Vishay Dale	2.00 Ω Resistor, Size 0603, 1%	1
R3	CRCW060319K6FKEA	Vishay Dale	19.6k Ω Resistor, Size 0603, 1%	1
R4	CRCW06032K49FKEA	Vishay Dale	2.49k Ω Resistor, Size 0603, 1%	1
R5	CRCW060320K0FKEA	Vishay Dale	20.0k Ω Resistor, Size 0603, 1%	1

Notes:

1. AVX: www.avx.com.
2. Murata: www.murata.com.
3. TDK: www.tdk.com
4. EPCOS: www.epcos.com.
5. MCC: www.mccsemi.com.
6. Diode Inc.: www.diodes.com.
7. Vishay: www.vishay.com.
8. Cooper Bussmann: www.cooperbussmann.com.

Bill of Materials (Continued)

Item	Part Number	Manufacturer	Description	Qty.
R6, R14, R17	CRCW060310K0FKEA	Vishay Dale	10.0k Ω Resistor, Size 0603, 1%	3
R7	CRCW06034K99FKEA	Vishay Dale	4.99k Ω Resistor, Size 0603, 1%	1
R8	CRCW06032K87FKEA	Vishay Dale	2.87k Ω Resistor, Size 0603, 1%	1
R9	CRCW06032K006FKEA	Vishay Dale	2.00k Ω Resistor, Size 0603, 1%	1
R10	CRCW06031K18FKEA	Vishay Dale	1.18k Ω Resistor, Size 0603, 1%	1
R11	CRCW0603806RFKEA	Vishay Dale	806 Ω Resistor, Size 0603, 1%	1
R12	CRCW0603475RFKEA	Vishay Dale	475 Ω Resistor, Size 0603, 1%	1
R13	CRCW06030000FKEA	Vishay Dale	0 Ω Resistor, Size 0603, 5%	1
R15	CRCW060349R9FKEA	Vishay Dale	49.9 Ω Resistor, Size 0603, 1%	1
R16, R18	CRCW06031R21FKEA	Vishay Dale	1.21 Ω Resistor, Size 0603, 1%	2
R20	Open			
All Reference designators ending with "A"	Open			
U1	MIC24054YJL	Micrel, Inc.⁽⁹⁾	9A, High-Efficiency, Synchronous DC/DC Buck Regulator with HyperLight Load	1

Note:

9. Micrel, Inc.: www.micrel.com.

PCB Layout Recommendations⁽¹⁾

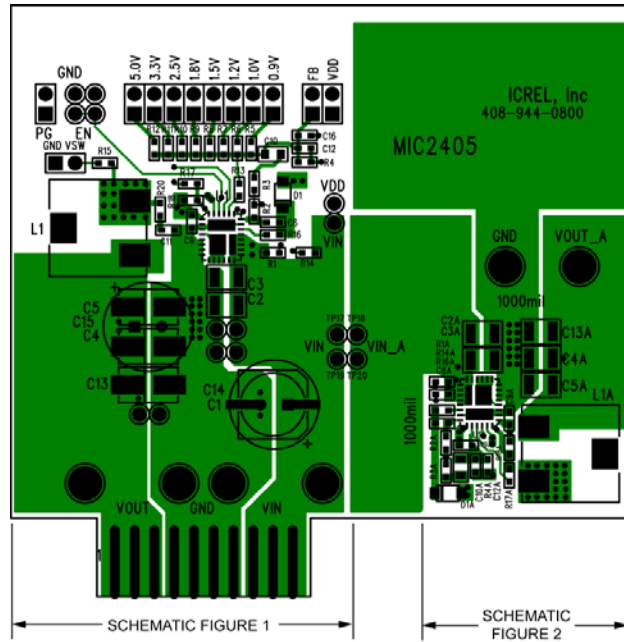

Top Layer

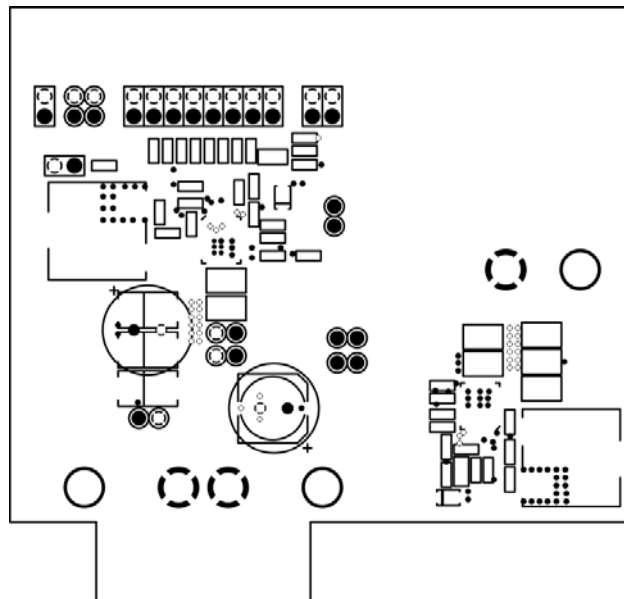

Mid-Layer 1 (Power Ground Plane)

Note:

1. Refer to "PCB Layout Guideline" section for component placement and layout in MIC24054 datasheet on Micrel web page (www.micrel.com)

PCB Layout Recommendations⁽¹⁾ (Continued)

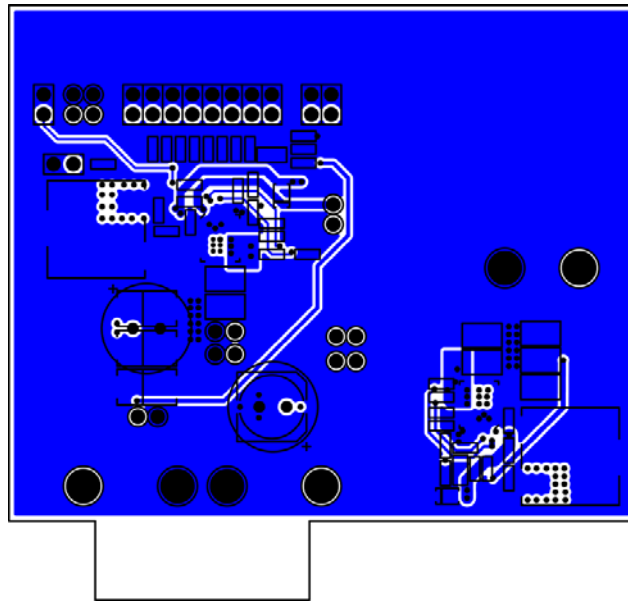

Mid-Layer 2

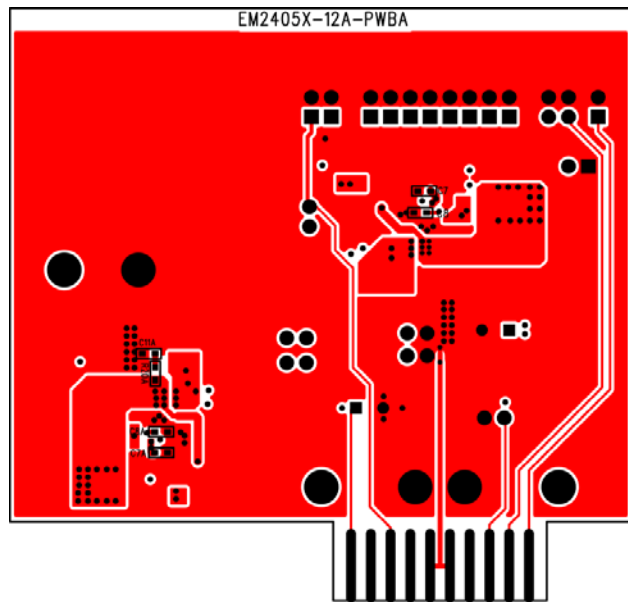

Bottom Layer

MICREL, INC. 2180 FORTUNE DRIVE SAN JOSE, CA 95131 USA
TEL +1 (408) 944-0800 FAX +1 (408) 474-1000 WEB <http://www.micrel.com>

Micrel makes no representations or warranties with respect to the accuracy or completeness of the information furnished in this data sheet. This information is not intended as a warranty and Micrel does not assume responsibility for its use. Micrel reserves the right to change circuitry, specifications and descriptions at any time without notice. No license, whether express, implied, arising by estoppel or otherwise, to any intellectual property rights is granted by this document. Except as provided in Micrel's terms and conditions of sale for such products, Micrel assumes no liability whatsoever, and Micrel disclaims any express or implied warranty relating to the sale and/or use of Micrel products including liability or warranties relating to fitness for a particular purpose, merchantability, or infringement of any patent, copyright or other intellectual property right.

Micrel Products are not designed or authorized for use as components in life support appliances, devices or systems where malfunction of a product can reasonably be expected to result in personal injury. Life support devices or systems are devices or systems that (a) are intended for surgical implant into the body or (b) support or sustain life, and whose failure to perform can be reasonably expected to result in a significant injury to the user. A Purchaser's use or sale of Micrel Products for use in life support appliances, devices or systems is a Purchaser's own risk and Purchaser agrees to fully indemnify Micrel for any damages resulting from such use or sale.

© 2013 Micrel, Incorporated.

X-ON Electronics

Largest Supplier of Electrical and Electronic Components

Click to view similar products for [Switching Voltage Regulators](#) category:

Click to view products by [Microchip](#) manufacturer:

Other Similar products are found below :

[FAN53610AUC33X](#) [FAN53611AUC123X](#) [FAN48610BUC33X](#) [FAN48610BUC45X](#) [FAN48617UC50X](#) [R3](#) [430464BB](#) [KE177614](#)
[MAX809TTR](#) [NCV891234MW50R2G](#) [NCP81103MNTXG](#) [NCP81203PMNTXG](#) [NCP81208MNTXG](#) [NCP81109GMNTXG](#)
[SCY1751FCCT1G](#) [NCP81109JMNTXG](#) [AP3409ADNTR-G1](#) [NCP81241MNTXG](#) [LTM8064IY](#) [LT8315EFE#TRPBF](#) [LTM4668AIY#PBF](#)
[NCV1077CSTBT3G](#) [XCL207A123CR-G](#) [MPM54304GMN-0002](#) [MPM54304GMN-0003](#) [XDPE132G5CG000XUMA1](#) [MP8757GL-P](#)
[MIC23356YFT-TR](#) [LD8116CGL](#) [HG2269M/TR](#) [OB2269](#) [XD3526](#) [U6215A](#) [U6215B](#) [U6620S](#) [LTC3803ES6#TR](#) [LTC3803ES6#TRM](#)
[LTC3412IFE](#) [LT1425IS](#) [MAX25203BATJA/VY+](#) [MAX77874CEWM+](#) [XC9236D08CER-G](#) [ISL95338IRTZ](#) [MP3416GJ-P](#) [BD9S201NUX-CE2](#) [MP5461GC-Z](#) [MPQ4415AGQB-Z](#) [MPQ4590GS-Z](#) [MCP1603-330IMC](#) [MCP1642B-18IMC](#)