

## 60V<sub>IN</sub>, 3A Synchronous Buck Regulator

### Features

- 4.6V to 60V Operating Input Voltage Supply
- Up to 3A Output Current
- Integrated High-Side and Low-Side N-Channel MOSFETs
- HyperLight Load<sup>®</sup> (MIC28511-1) and Hyper Speed Control<sup>®</sup> (MIC28511-2) Architecture
- Enable Input and Power Good (PGOOD) Output
- Programmable Current-Limit and Foldback “Hiccup” Mode Short-Circuit Protection
- Built-In 5V Regulator for Single-Supply Operation
- Adjustable 200 kHz to 680 kHz Switching Frequency
- Fixed 5 ms Soft-Start
- Internal Compensation and Thermal Shutdown
- Thermally-Enhanced 24-Pin 3 mm x 4 mm FQFN Package
- -40°C to +125°C Junction Temperature Range

### Applications

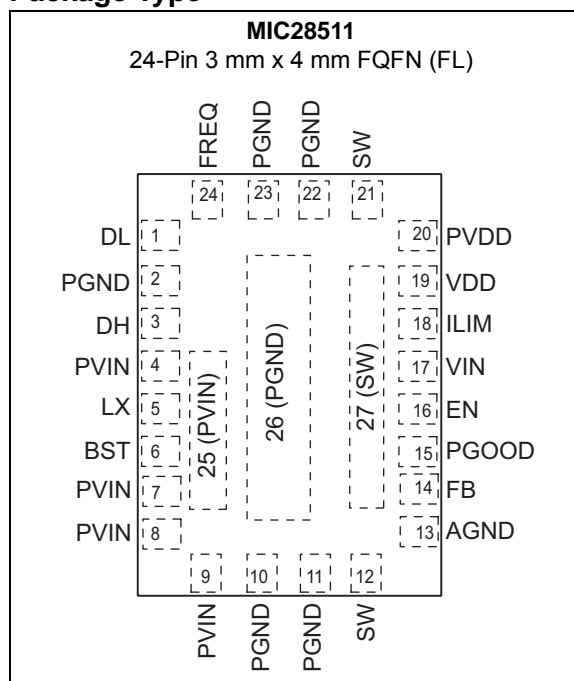
- Industrial Power Supplies
- Distributed Supply Regulation
- Base Station Power Supplies
- Wall Transformer Regulation
- High-Voltage Single-Board Systems

### General Description

The MIC28511 is a synchronous step-down switching regulator with internal power switches capable of providing up to 3A output current from a wide input supply range from 4.6V to 60V. The output voltage is adjustable down to 0.8V with a guaranteed accuracy of ±1%. A constant switching frequency can be programmed from 200 kHz to 680 kHz. The Hyper Speed Control<sup>®</sup> and HyperLight Load<sup>®</sup> architectures of the MIC28511 allow for high V<sub>IN</sub> (low V<sub>OUT</sub>) operation and ultra-fast transient response while reducing the required output capacitance and providing very good light-load efficiency.

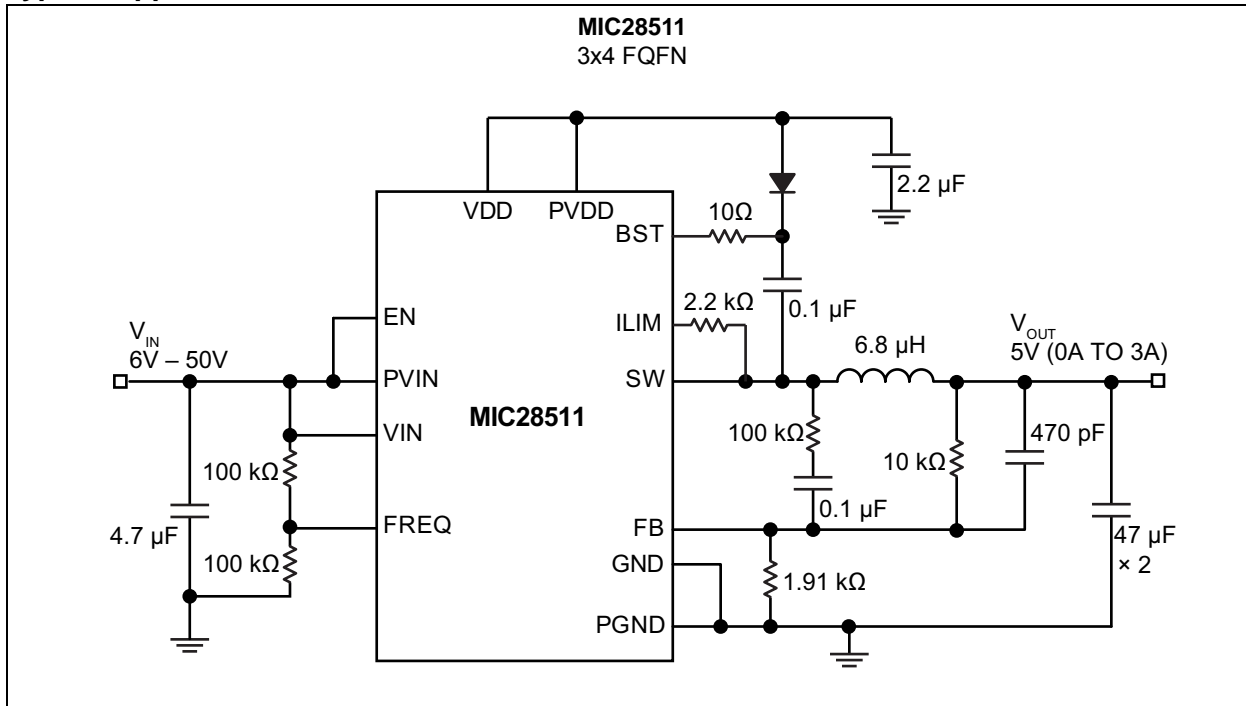
The MIC28511 offers a full suite of features to ensure protection under fault conditions. These include undervoltage lockout to ensure proper operation under power sag conditions, internal soft-start to reduce inrush current, foldback current-limit, “hiccup” mode short-circuit protection and thermal shutdown.

### Package Type

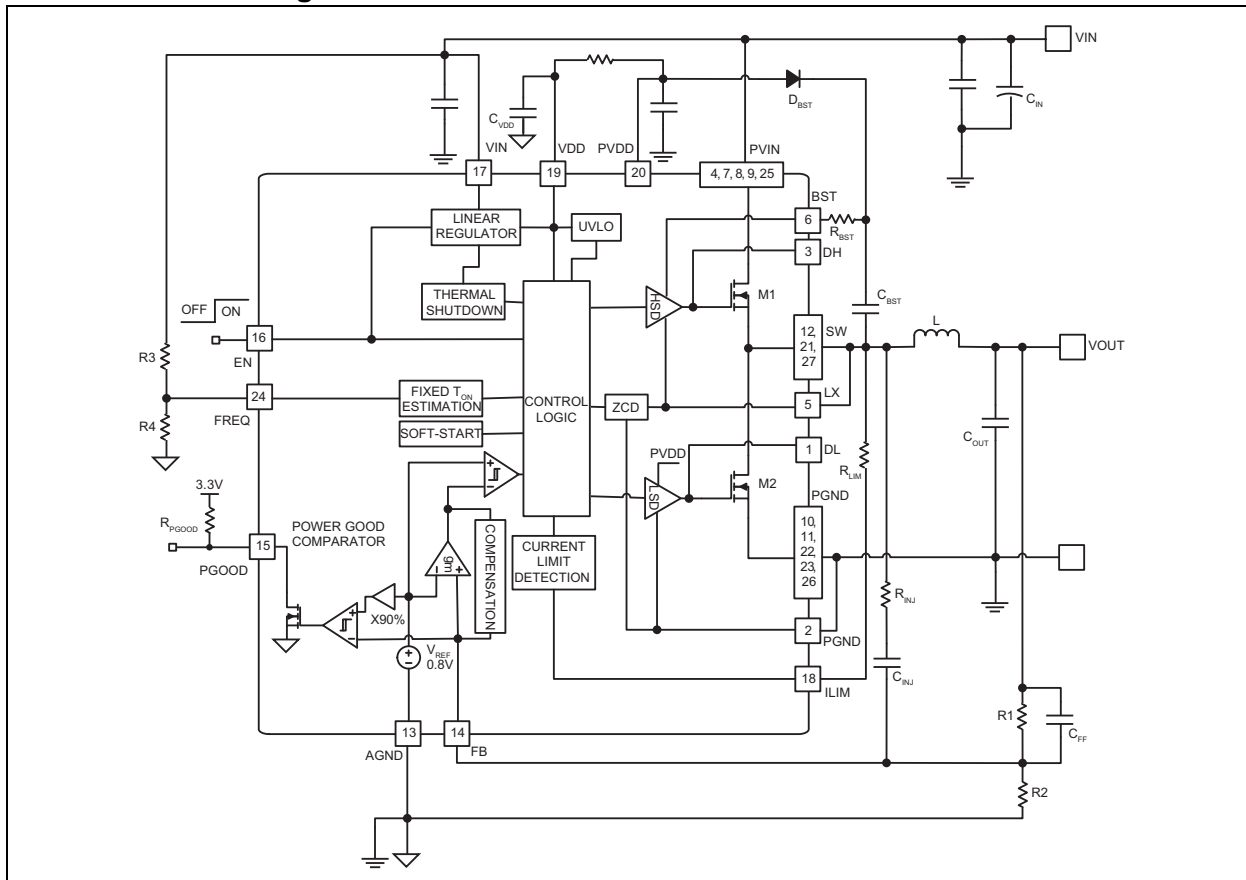


# MIC28511

## Typical Application Circuit



## Functional Block Diagram



## 1.0 ELECTRICAL CHARACTERISTICS

### Absolute Maximum Ratings †

$PV_{IN}, V_{IN}$ to PGND.....	-0.3V to +65V
$V_{DD}, P_{VDD}$ to PGND.....	-0.3V to +6V
$V_{BST}$ to $V_{SW}, V_{LX}$ .....	-0.3V to +6V
$V_{BST}$ to PGND.....	-0.3V to ( $V_{IN} + 6V$ )
$V_{SW}$ to PGND.....	-0.3V to ( $V_{IN} + 0.3V$ )
$V_{LX}, V_{FREQ}, V_{ILIM}, V_{EN}$ to AGND.....	-0.3V to ( $V_{IN} + 0.3V$ )
$V_{FB}, V_{PG}$ to AGND.....	-0.3V to ( $V_{DD} + 0.3V$ )
PGND to AGND.....	-0.3V to +0.3V
ESD Rating <sup>(1)</sup> (HBM).....	1.5 kV
ESD Rating <sup>(1)</sup> (MM).....	150V

### Operating Ratings ‡

Supply Voltage ( $PV_{IN}, V_{IN}$ ).....	+4.6V to +60V
Enable Input ( $V_{EN}$ ).....	0V to $V_{IN}$
$V_{SW}, V_{FREQ}, V_{ILIM}$ .....	0V to $V_{IN}$

† **Notice:** Stresses above those listed under “Absolute Maximum Ratings” may cause permanent damage to the device. This is a stress rating only and functional operation of the device at those or any other conditions above those indicated in the operational sections of this specification is not intended. Exposure to maximum rating conditions for extended periods may affect device reliability.

‡ **Notice:** The device is not guaranteed to function outside its operating ratings.

**Note 1:** Devices are ESD sensitive. Handling precautions are recommended. Human body model, 1.5 kΩ in series with 100 pF.

# MIC28511

**TABLE 1-1: ELECTRICAL CHARACTERISTICS**

Electrical Characteristics: $V_{IN} = 12V$ , $T_A = 25^\circ C$ , unless noted. <b>Bold</b> values indicate $-40^\circ C \leq T_J \leq +125^\circ C$ . (Note 1).					
Parameters	Min.	Typ.	Max.	Units	Conditions
<b>Power Supply Input</b>					
Input Voltage Range ( $PV_{IN}$ , $V_{IN}$ )	<b>4.6</b>	—	<b>60</b>	V	—
Quiescent Supply Current	—	0.4	<b>0.75</b>	mA	$V_{FB} = 1.5V$ (MIC28511-1)
	—	0.7	<b>1.5</b>		$V_{FB} = 1.5V$ (MIC28511-2)
Shutdown Supply Current	—	0.1	<b>10</b>	$\mu A$	SW unconnected, $V_{EN} = 0V$
<b><math>V_{DD}</math> Supply</b>					
$V_{DD}$ Output Voltage	<b>4.8</b>	5.2	<b>5.4</b>	V	$V_{IN} = 7V$ to $60V$ , $I_{VDD} = 10$ mA
$V_{DD}$ UVLO Threshold	<b>3.8</b>	4.2	<b>4.6</b>	V	$V_{DD}$ rising
$V_{DD}$ UVLO Hysteresis	—	400	—	mV	—
Load Regulation at 40 mA	0.6	2	4.0	%	—
<b>Reference</b>					
Feedback Reference Voltage	<b>0.792</b>	0.8	<b>0.808</b>	V	$0^\circ C \leq T_J \leq +85^\circ C$ ( $\pm 1.0\%$ )
	<b>0.784</b>	0.8	<b>0.816</b>		$-40^\circ C \leq T_J \leq +125^\circ C$ ( $\pm 2\%$ )
FB Bias Current	—	5	<b>500</b>	nA	$V_{FB} = 0.8V$
<b>Enable Control</b>					
EN Logic Level High	<b>1.8</b>	—	—	V	—
EN Logic Level Low	—	—	<b>0.6</b>		—
EN Hysteresis	—	200	—	mV	—
EN Bias Current	—	5	<b>40</b>	$\mu A$	$V_{EN} = 12V$
<b>Oscillator</b>					
Switching Frequency	<b>450</b>	680	<b>800</b>	kHz	$V_{FREQ} = V_{IN}$
	—	340	—		$V_{FREQ} = 50\% \times V_{IN}$
Maximum Duty Cycle	—	85	—	%	—
Minimum Duty Cycle	—	0	—		$V_{FB} > 0.8V$
Minimum Off-Time	110	200	270	ns	—
<b>Internal MOSFET</b>					
High-Side NMOS On-Resistance	—	51	—	m $\Omega$	—
Low-Side NMOS On-Resistance	—	28	—		—
<b>Short-Circuit Protection</b>					
Current-Limit Threshold	-30	-14	0	mV	$V_{FB} = 0.79V$
Short-Circuit Threshold	-24	-7	8		$V_{FB} = 0V$
Current-Limit Source Current	50	70	90	$\mu A$	$V_{FB} = 0.79V$
Short-Circuit Source Current	25	36	43		$V_{FB} = 0V$

**Note 1:** Specification for packaged product only.

**TABLE 1-1: ELECTRICAL CHARACTERISTICS (CONTINUED)**

Electrical Characteristics: $V_{IN} = 12V$ , $T_A = 25^\circ C$ , unless noted. <b>Bold</b> values indicate $-40^\circ C \leq T_J \leq +125^\circ C$ . (Note 1).					
Parameters	Min.	Typ.	Max.	Units	Conditions
<b>Leakage</b>					
SW, BST Leakage Current	—	—	50	$\mu A$	—
<b>Power Good (PGOOD)</b>					
PGOOD Threshold Voltage	<b>85</b>	90	<b>95</b>	% $V_{OUT}$	Sweep $V_{FB}$ from low to high
PGOOD Hysteresis	—	6	—		Sweep $V_{FB}$ from high to low
PGOOD Delay Time	—	100	—	$\mu s$	Sweep $V_{FB}$ from low to high
PGOOD Low Voltage	—	70	<b>200</b>	mV	$V_{FB} < 90\% \times V_{NOM}$ , $I_{PGOOD} = 1\text{ mA}$
<b>Thermal Protection</b>					
Overtemperature Shutdown	—	160	—	$^\circ C$	$T_J$ Rising
Overtemperature Shutdown Hysteresis	—	15	—	$^\circ C$	—
<b>Soft-Start</b>					
Soft-Start Time	—	5	—	ms	—

**Note 1:** Specification for packaged product only.

# MIC28511

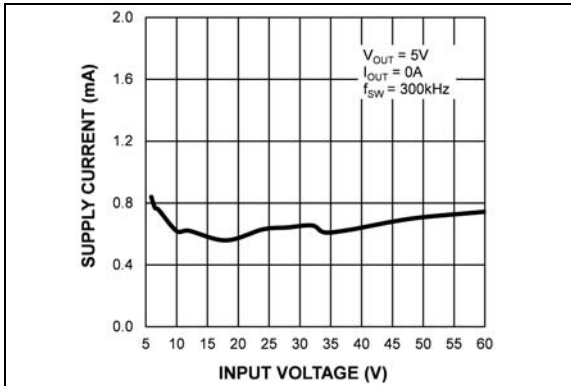
## TEMPERATURE SPECIFICATIONS

Parameters	Sym.	Min.	Typ.	Max.	Units	Conditions
<b>Temperature Ranges</b>						
Junction Operating Temperature	$T_J$	-40	—	+125	°C	Note 1
Storage Temperature Range	$T_S$	-65	—	+150	°C	—
Maximum Junction Temperature	$T_J$	—	—	+150	°C	—
Lead Temperature	—	—	—	+300	°C	Soldering, 10s
<b>Package Thermal Resistances</b>						
Thermal Resistance 3 mm x 4 mm FQFN-24LD	$\theta_{JA}$	—	30	—	°C/W	—

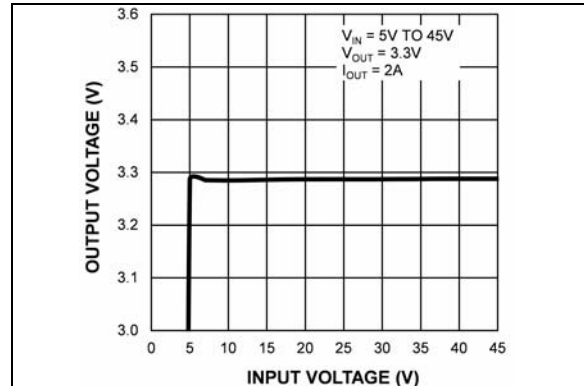
**Note 1:** The maximum allowable power dissipation is a function of ambient temperature, the maximum allowable junction temperature and the thermal resistance from junction to air (i.e.,  $T_A$ ,  $T_J$ ,  $\theta_{JA}$ ). Exceeding the maximum allowable power dissipation will cause the device operating junction temperature to exceed the maximum +125°C rating. Sustained junction temperatures above +125°C can impact the device reliability.

## 2.0 TYPICAL PERFORMANCE CURVES

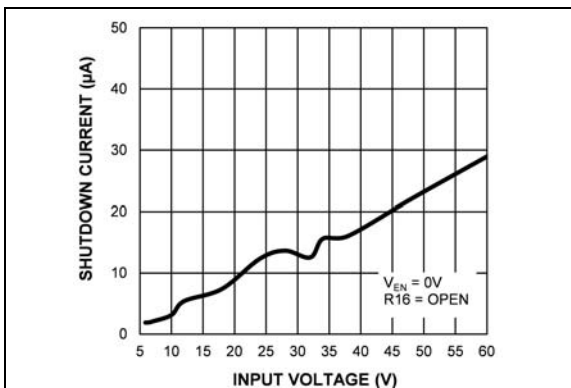
**Note:** The graphs and tables provided following this note are a statistical summary based on a limited number of samples and are provided for informational purposes only. The performance characteristics listed herein are not tested or guaranteed. In some graphs or tables, the data presented may be outside the specified operating range (e.g., outside specified power supply range) and therefore outside the warranted range.



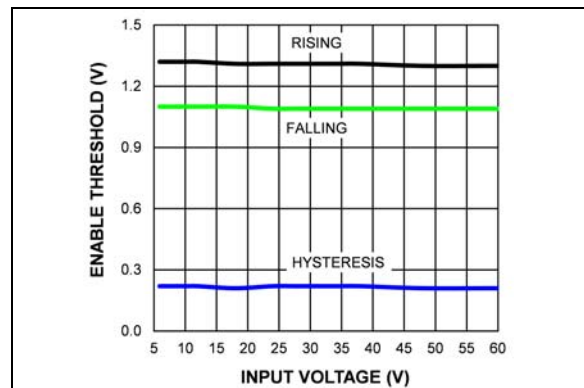
**FIGURE 2-1:**  $V_{IN}$  Operating Supply Current vs. Input Voltage (MIC28511-1).



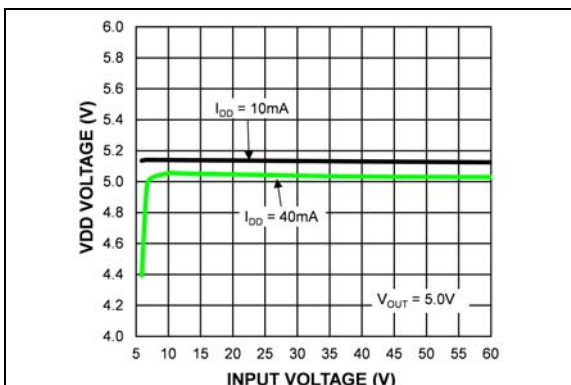
**FIGURE 2-4:** Output Voltage vs. Input Voltage (MIC28511-1).



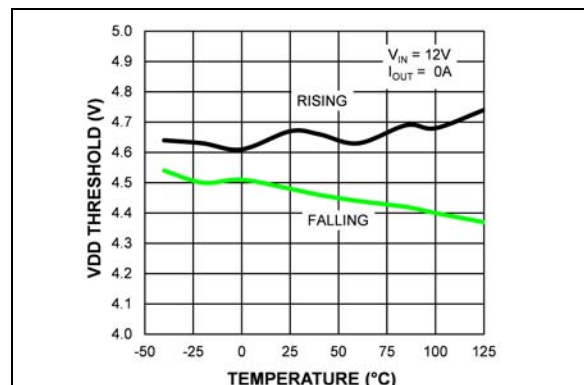
**FIGURE 2-2:**  $V_{IN}$  Shutdown Current vs. Input Voltage.



**FIGURE 2-5:** Enable Threshold vs. Input Voltage (MIC28511-1).

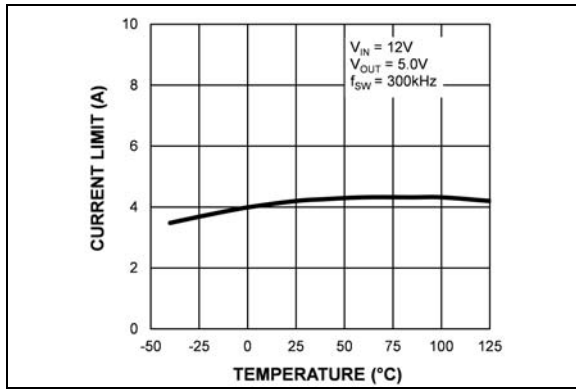


**FIGURE 2-3:**  $V_{DD}$  Voltage vs. Input Voltage (MIC28511-1).

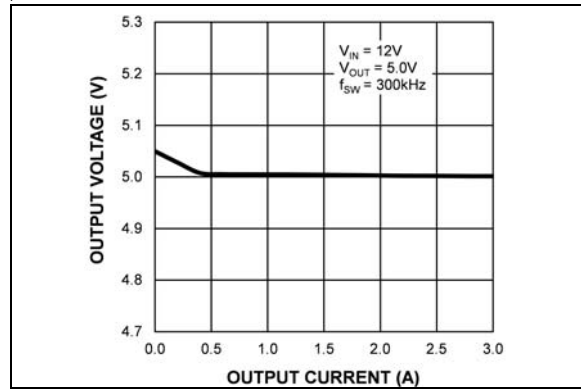


**FIGURE 2-6:**  $V_{DD}$  UVLO Threshold vs. Temperature (MIC28511-1).

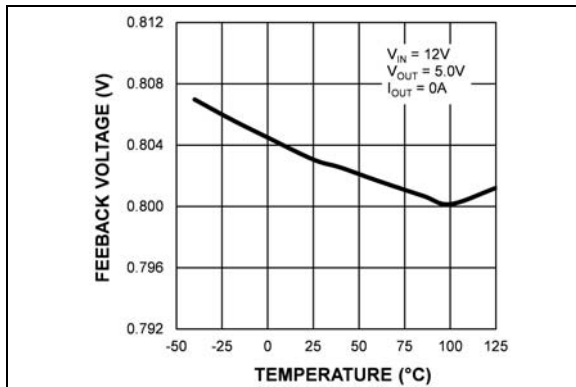
# MIC28511



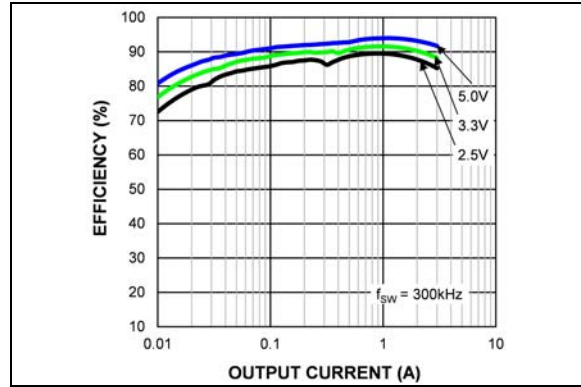
**FIGURE 2-7:** Output Peak Current Limit vs. Temperature (MIC28511-1).



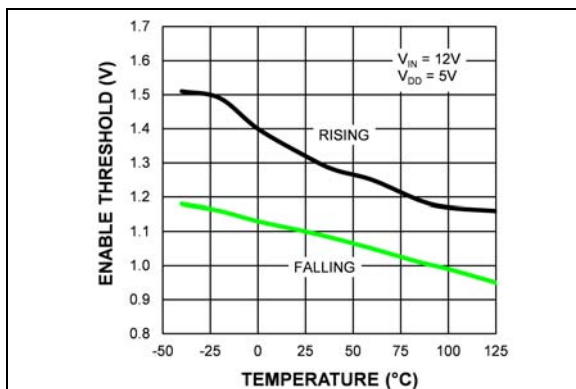
**FIGURE 2-10:** Output Voltage vs. Output Current (MIC28511-1).



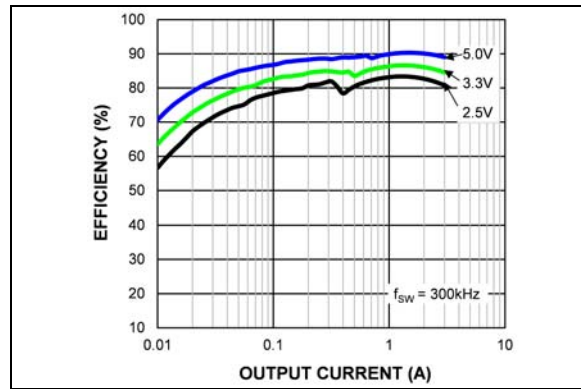
**FIGURE 2-8:** Feedback Voltage vs. Temperature (MIC28511-1).



**FIGURE 2-11:** Efficiency ( $V_{IN} = 12V$ ) vs. Output Current (MIC28511-1).

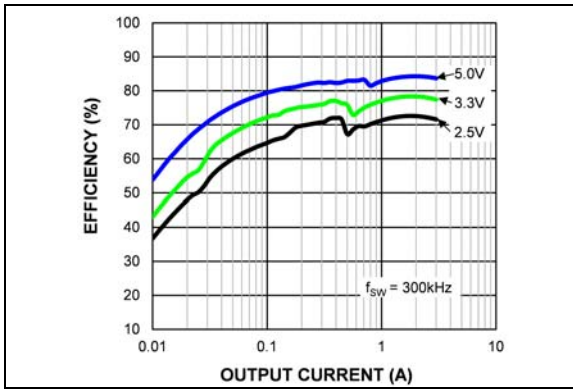


**FIGURE 2-9:** Enable Threshold vs. Temperature (MIC28511-1).

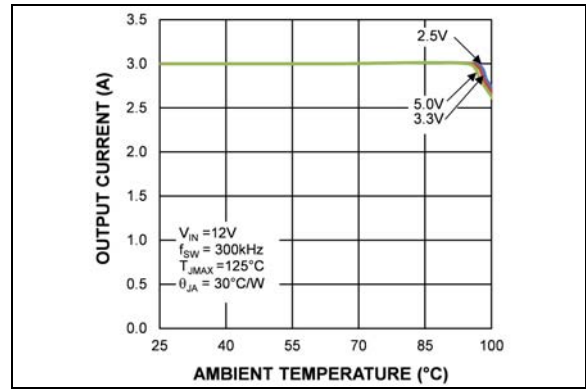


**FIGURE 2-12:** Efficiency ( $V_{IN} = 24V$ ) vs. Output Current (MIC28511-1).

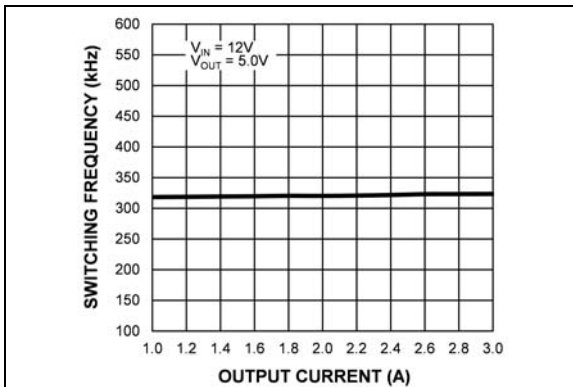




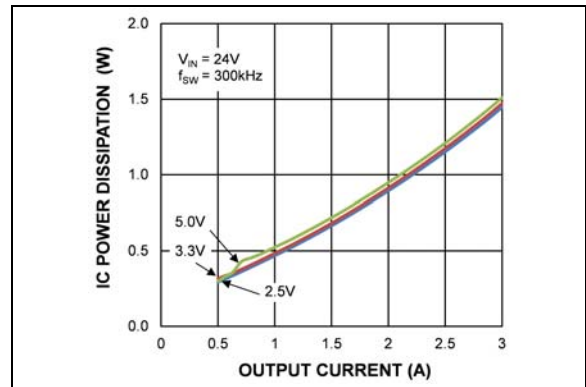
**FIGURE 2-13:** Efficiency ( $V_{IN} = 48V$ ) vs. Output Current (MIC28511-1).



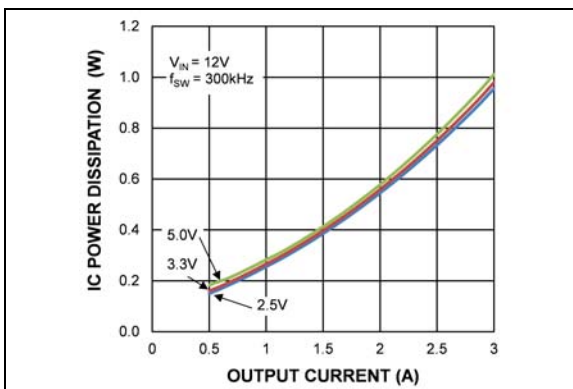
**FIGURE 2-16:** 12V Input Thermal Derating (MIC28511-1).



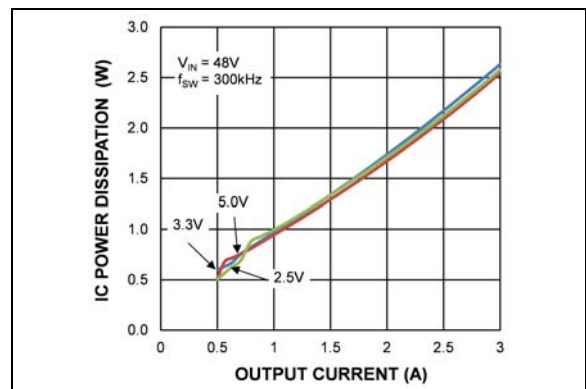
**FIGURE 2-14:** Switching Frequency vs. Output Current (MIC28511-1).



**FIGURE 2-17:** IC Power Dissipation vs. Output Current (MIC28511-1).

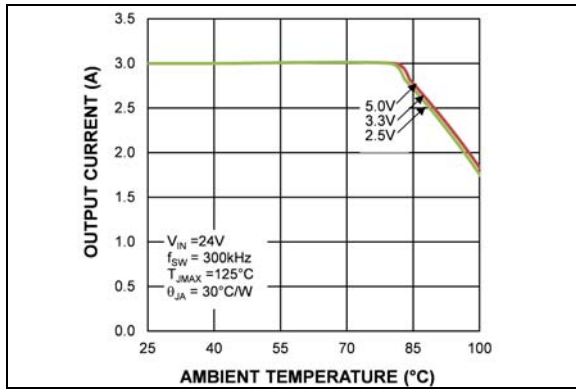


**FIGURE 2-15:** IC Power Dissipation vs. Output Current (MIC28511-1).

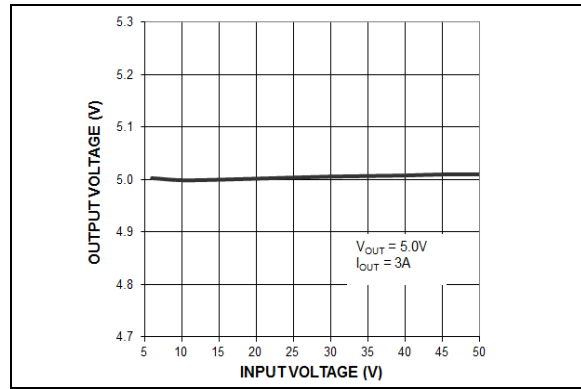


**FIGURE 2-18:** IC Power Dissipation vs. Output Current (MIC28511-1).

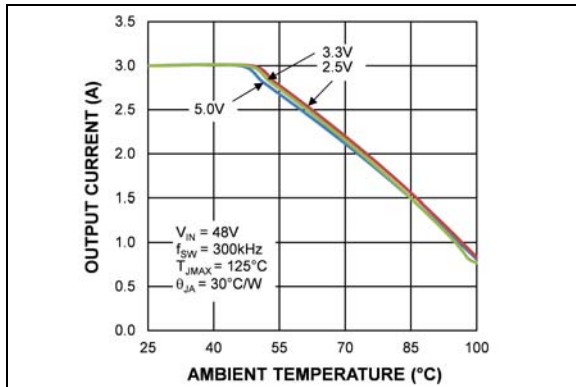
# MIC28511



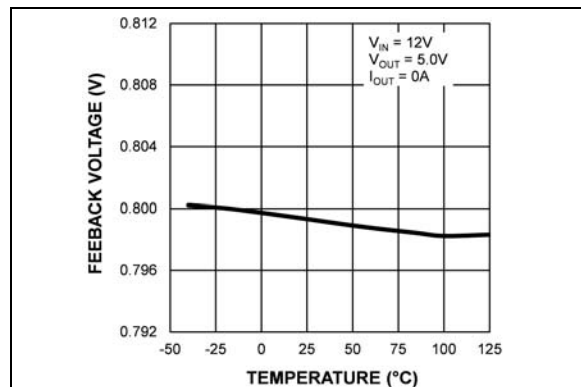
**FIGURE 2-19:** 24V Input Thermal Derating (MIC28511-1).



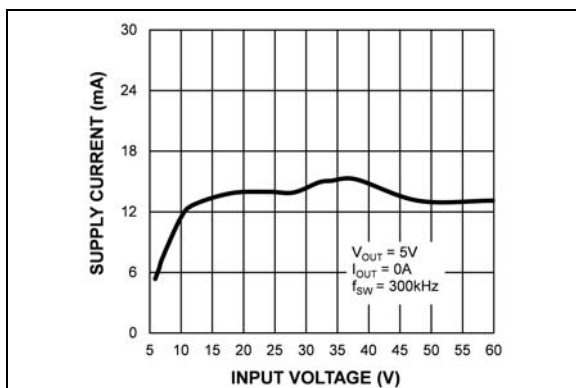
**FIGURE 2-22:** Output Voltage vs. Input Voltage (MIC28511-2).



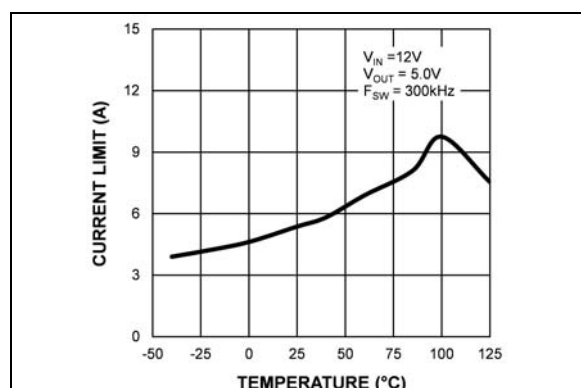
**FIGURE 2-20:** 48V Input Thermal Derating (MIC28511-1).



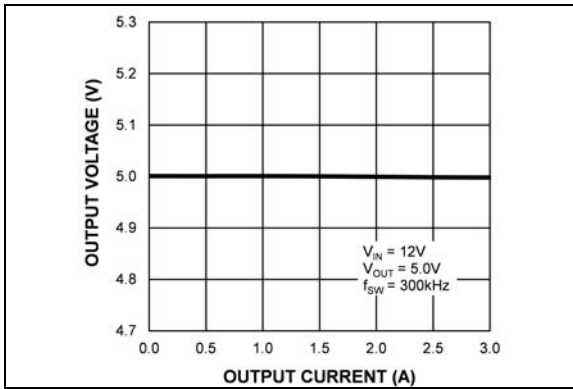
**FIGURE 2-23:** Feedback Voltage vs. Temperature (MIC28511-2).



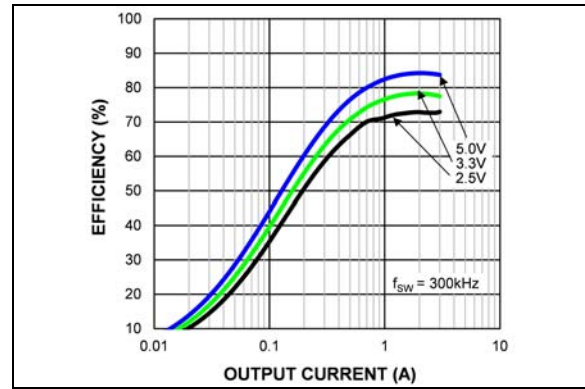
**FIGURE 2-21:**  $V_{IN}$  Operating Supply Current vs. Input Voltage (MIC28511-2).



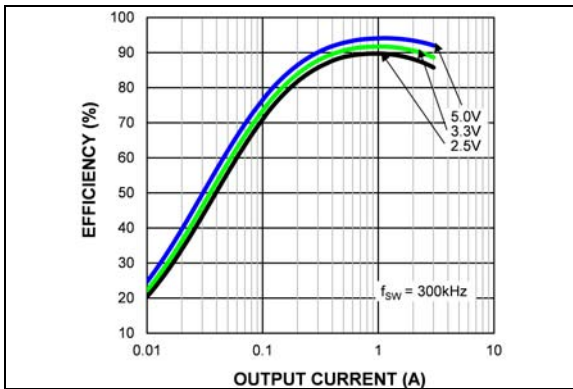
**FIGURE 2-24:** Output Peak Current Limit vs. Temperature (MIC28511-2).



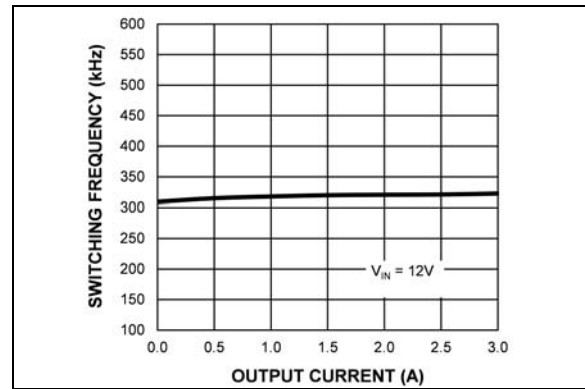
**FIGURE 2-25:** Output Voltage vs. Output Current (MIC28511-2).



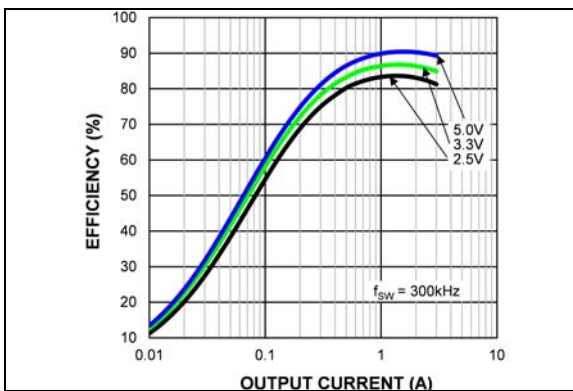
**FIGURE 2-28:** Efficiency ( $V_{IN} = 48V$ ) vs. Output Current (MIC28511-2).



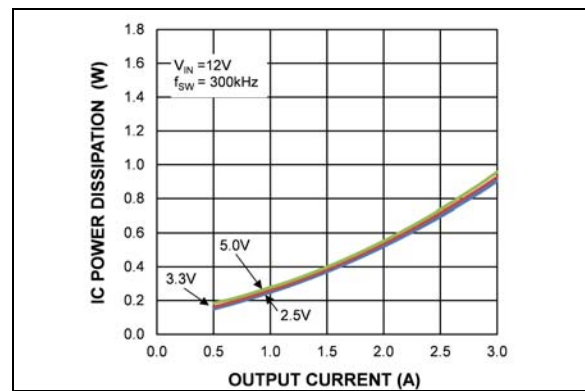
**FIGURE 2-26:** Efficiency ( $V_{IN} = 12V$ ) vs. Output Current (MIC28511-2).



**FIGURE 2-29:** Switch Frequency vs. Output Current (MIC28511-2).

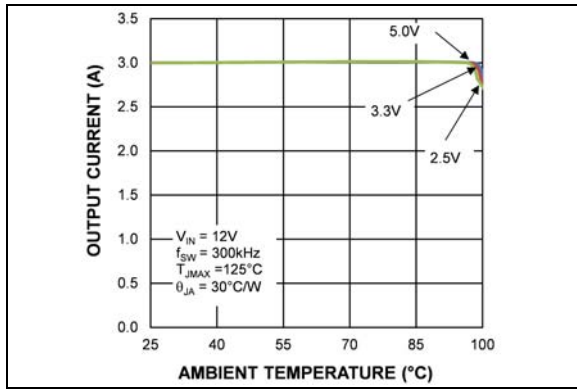


**FIGURE 2-27:** Efficiency ( $V_{IN} = 24V$ ) vs. Output Current (MIC28511-2).

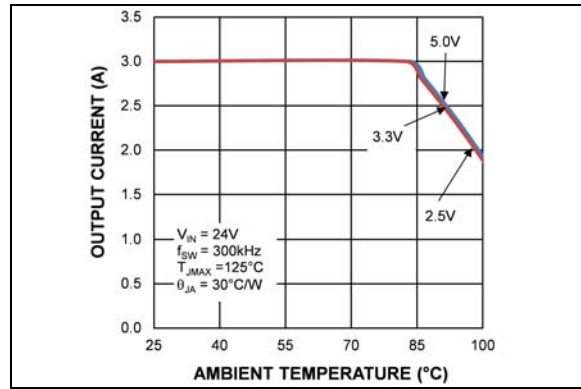


**FIGURE 2-30:** IC Power Dissipation vs. Output Current (MIC28511-2).

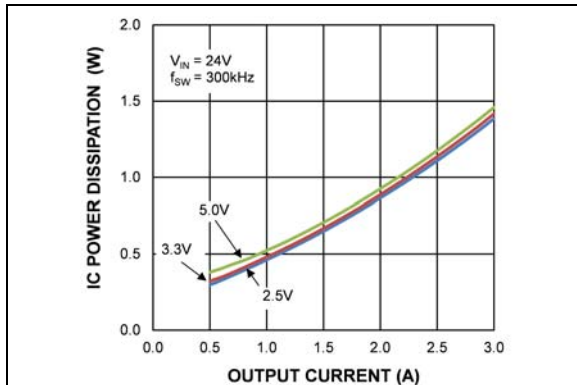
# MIC28511



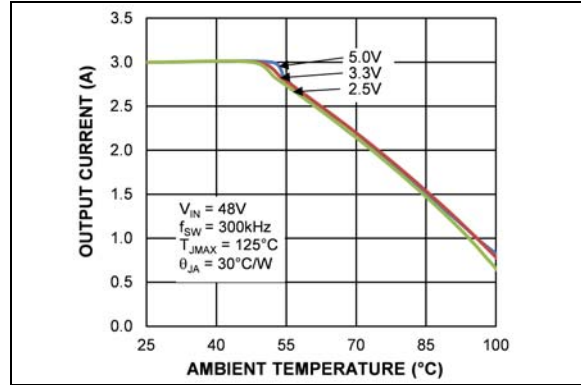
**FIGURE 2-31:** 12V Input Thermal Derating (MIC28511-2).



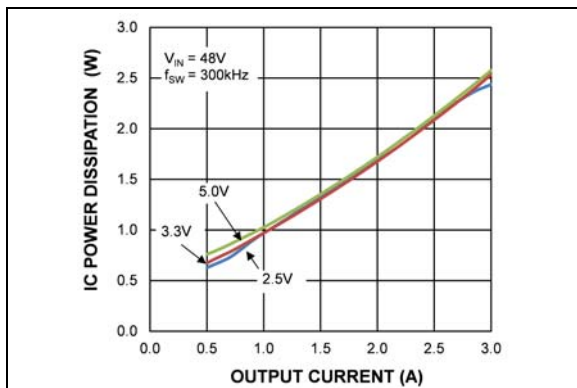
**FIGURE 2-34:** 24V Input Thermal Derating (MIC28511-2).



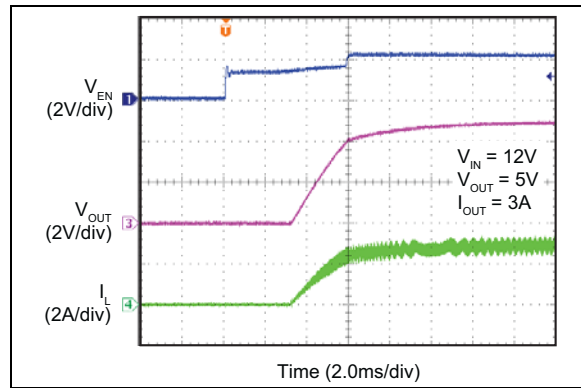
**FIGURE 2-32:** IC Power Dissipation vs. Output Current (MIC28511-2).



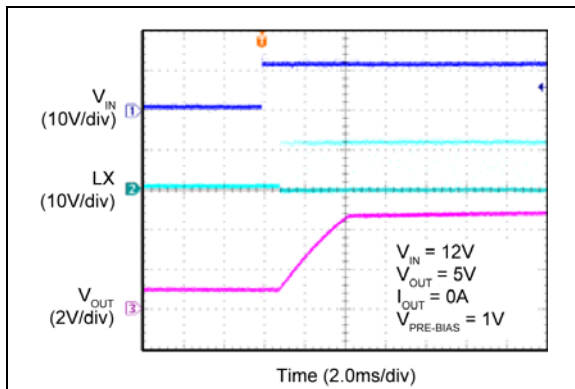
**FIGURE 2-35:** 48V Input Thermal Derating (MIC28511-2).



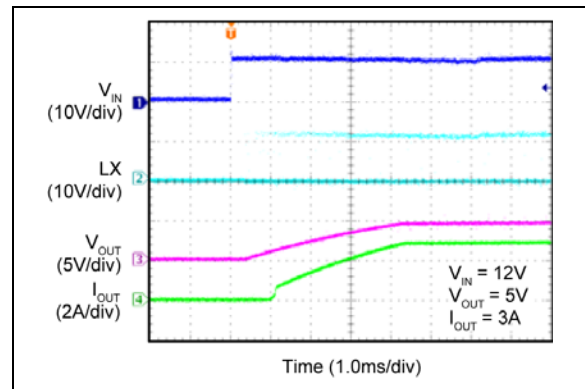
**FIGURE 2-33:** IC Power Dissipation vs. Output Current (MIC28511-2).



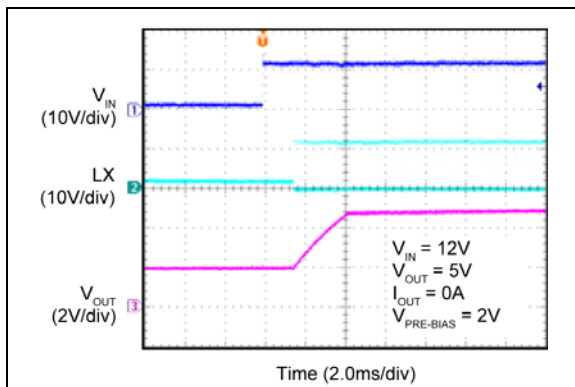
**FIGURE 2-36:** Enable Turn-On Delay and Rise Time.



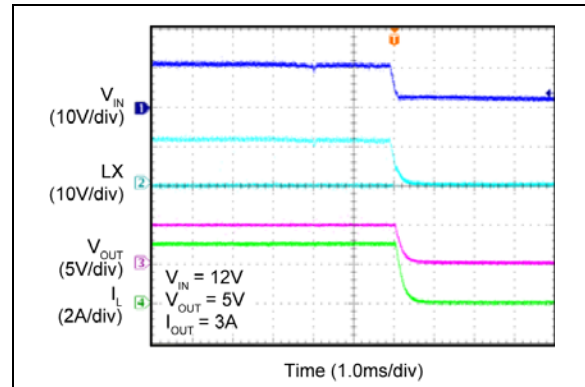
**FIGURE 2-37:** Start-Up with Pre-Biased Output at 1V.



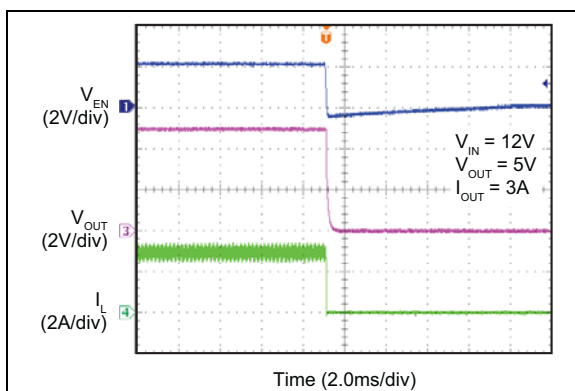
**FIGURE 2-40:**  $V_{IN}$  Turn-On.



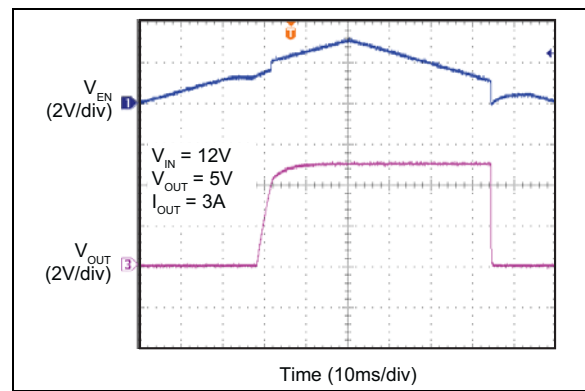
**FIGURE 2-38:** Start-Up with Pre-Biased Output at 2V.



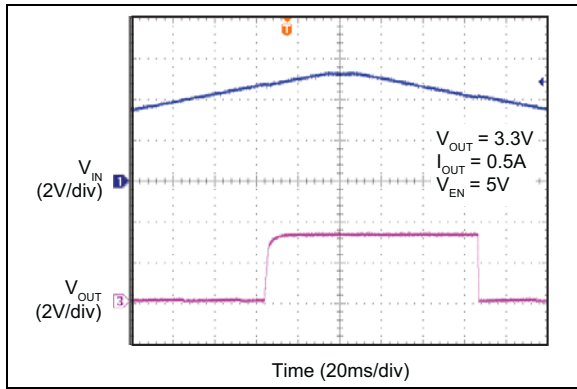
**FIGURE 2-41:**  $V_{IN}$  Turn-Off.



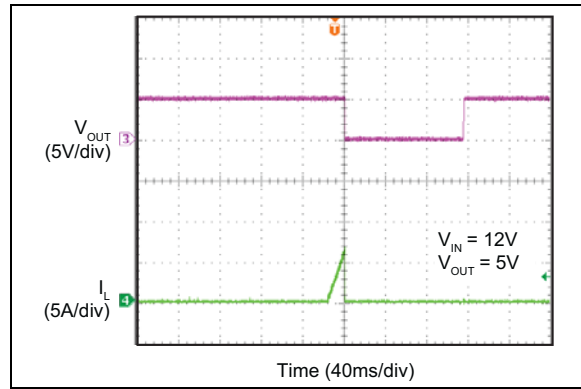
**FIGURE 2-39:** Enable Turn-Off Delay and Fall Time.



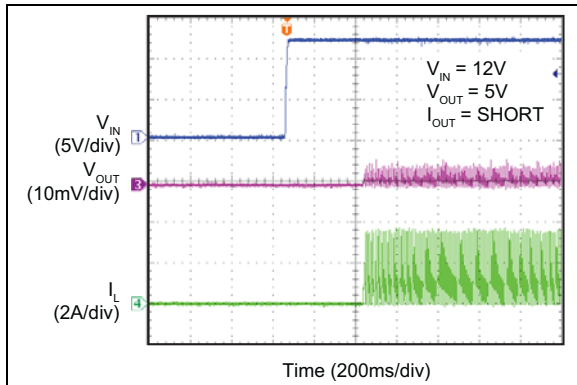
**FIGURE 2-42:** Enable Turn-On/Turn-Off.



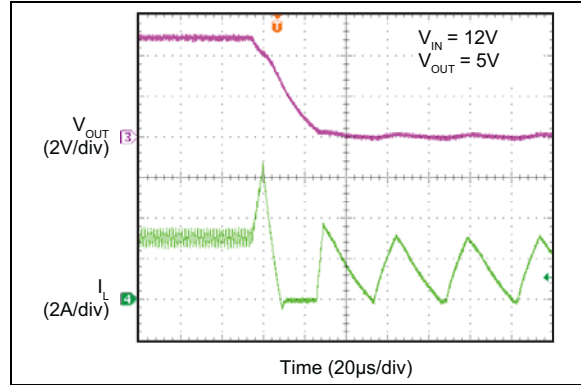
**FIGURE 2-43:**  $V_{IN}$  UVLO Thresholds.



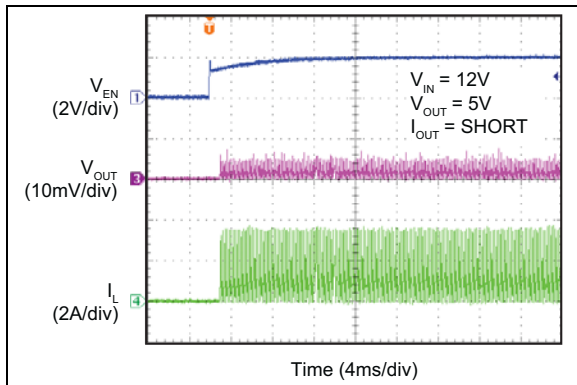
**FIGURE 2-46:** Output Peak Current-Limit Threshold.



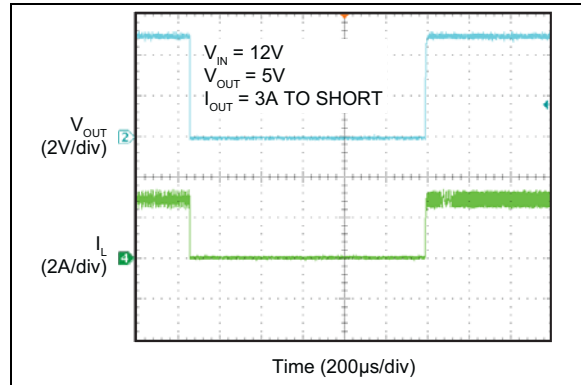
**FIGURE 2-44:** Power-Up into Short-Circuit.



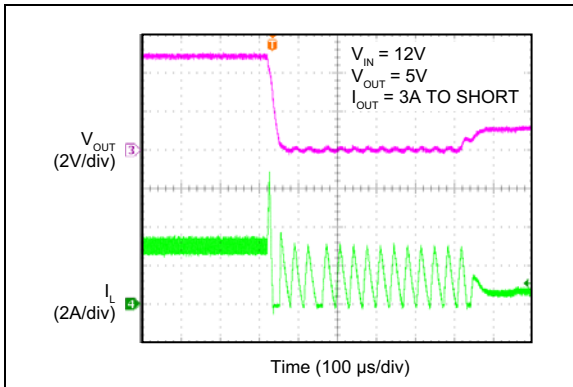
**FIGURE 2-47:** Short-Circuit.



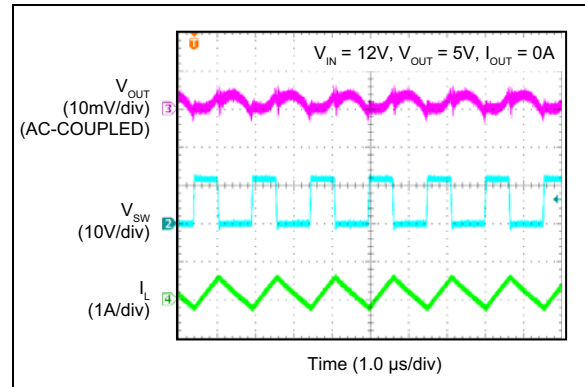
**FIGURE 2-45:** Enabled into Short.



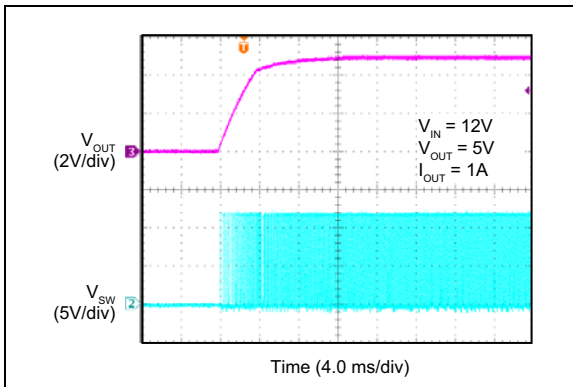
**FIGURE 2-48:** Output Recovery from Short-Circuit.



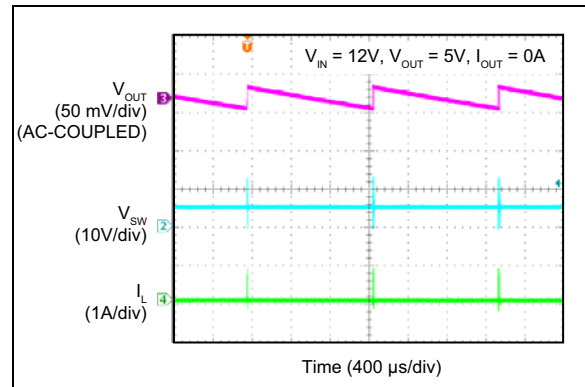
**FIGURE 2-49:** Output Recovery from Short-Circuit (Zoomed-In Version).



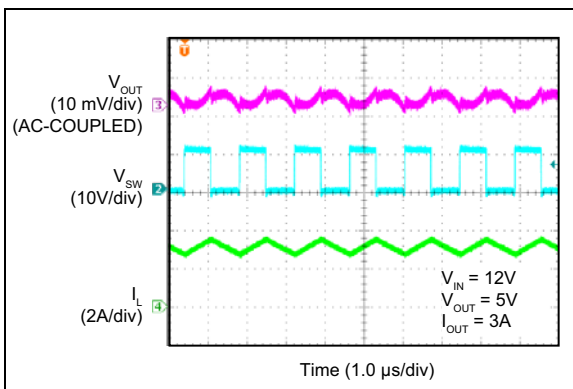
**FIGURE 2-52:** MIC28511-2 Switching Waveforms,  $I_{OUT} = 0A$ .



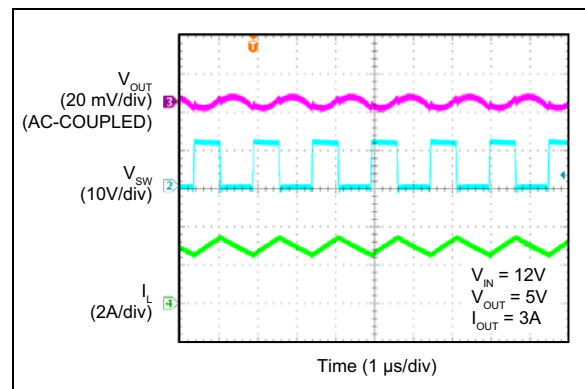
**FIGURE 2-50:** Output Recovery from Thermal Shutdown.



**FIGURE 2-53:** MIC28511-1 Switching Waveforms,  $I_{OUT} = 0A$ .

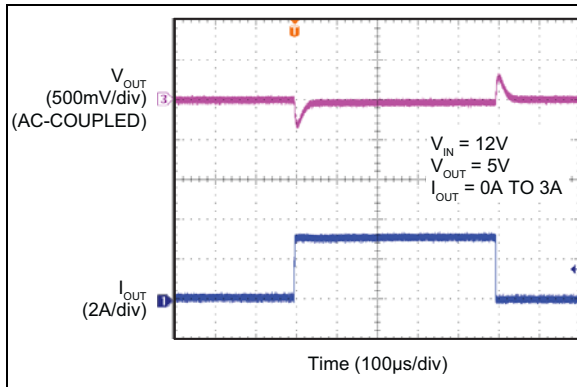


**FIGURE 2-51:** MIC28511-2 Switching Waveforms,  $I_{OUT} = 3A$ .

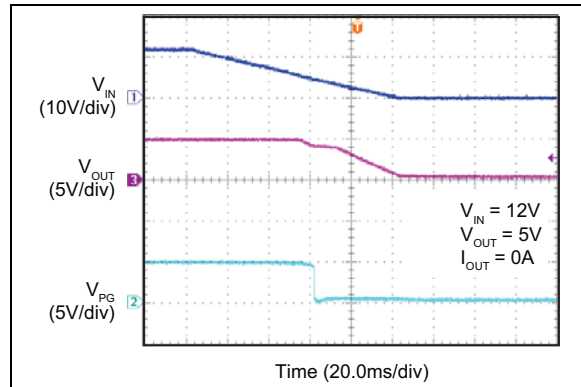


**FIGURE 2-54:** MIC28511-1 Switching Waveforms,  $I_{OUT} = 3A$ .

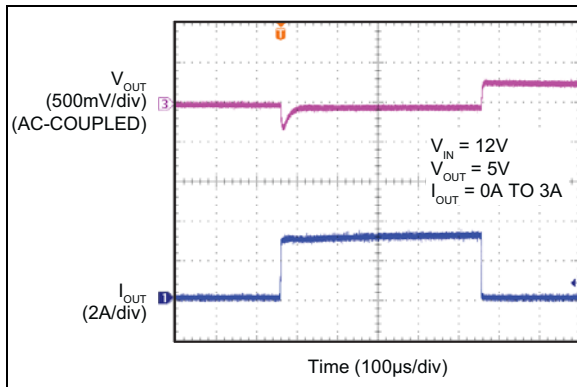
# MIC28511



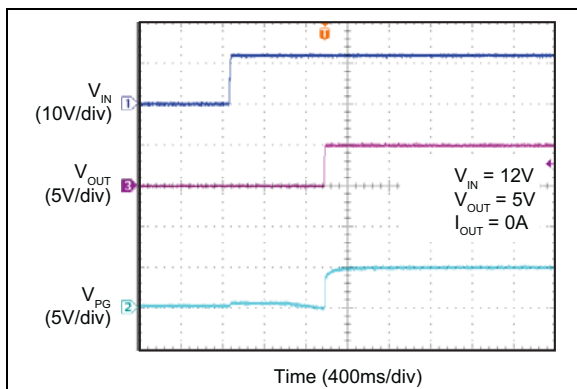
**FIGURE 2-55:** MIC28511-2 Transient Response.



**FIGURE 2-58:** Power Good at  $V_{IN}$  Soft Turn-Off.



**FIGURE 2-56:** MIC28511-1 Transient Response.



**FIGURE 2-57:** Power Good at  $V_{IN}$  Soft Turn-On.



## 3.0 PIN DESCRIPTIONS

The descriptions of the pins are listed in [Table 3-1](#).

**TABLE 3-1: PIN FUNCTION TABLE**

Pin Number	Symbol	Description
1	DL	Low-Side Gate Drive. Internal low-side power MOSFET gate connection. This pin must be left unconnected or floating.
2	PGND	PGND is the return path for the low-side driver circuit. Connect to the source of low-side MOSFETs (PGND, pins 10, 11, 22, 23 and 26) through a low-impedance path.
3	DH	High-Side Gate Drive. Internal high-side power MOSFET gate connection. This pin must be left unconnected or floating.
4, 7, 8, 9, 25 (25 is ePad)	PV <sub>IN</sub>	Power Input Voltage. The PV <sub>IN</sub> pins supply power to the internal power switch. Connect all PV <sub>IN</sub> pins together and bypass locally with ceramic capacitors. The positive terminal of the input capacitor should be placed as close as possible to the PV <sub>IN</sub> pins, the negative terminal of the input capacitor should be placed as close as possible to the PGND pins 10, 11, 22, 23, and 26.
5	LX	The LX pin is the return path for the high-side driver circuit. Connect the negative terminal of the bootstrap capacitor directly to this pin. Also connect this pin to the SW pins 12, 21, and 27, with a low-impedance path. The controller monitors voltages on this and PGND for zero current detection.
6	BST	Bootstrap Pin. This pin provides bootstrap supply for the high-side gate driver circuit. Connect a 0.1 $\mu$ F capacitor and an optional resistor in series from the LX (pin 5) to the BST.
10, 11, 22, 23, 26 (26 is ePad)	PGND	Power Ground. These pins are connected to the source of the low-side MOSFET. They are the return path for the step-down regulator power stage and should be tied together. The negative terminal of the input decoupling capacitor should be placed as close as possible to these pins.
12, 21, 27 (27 is ePad)	SW	Switch Node. The SW pins are the internal power switch outputs. These pins should be tied together and connected to the output inductor.
13	AGND	Analog Ground. The analog ground for V <sub>DD</sub> and the control circuitry. The analog ground return path should be separate from the power ground (PGND) return path.
14	FB	Feedback Input. The FB pin sets the regulated output voltage relative to the internal reference. This pin is connected to a resistor divider from the regulated output such that the FB pin is at 0.8V when the output is at the desired voltage.
15	PGOOD	The power good output is an open drain output requiring an external pull-up resistor to external bias. This pin is a high impedance open circuit when the voltage at FB pin is higher than 90% of the feedback reference voltage (typically 0.8V).
16	EN	Enable Input. The EN pin enables the regulator. When the pin is pulled below the threshold, the regulator will shut down to an ultra-low current state. A precise threshold voltage allows the pin to operate as an accurate UVLO. Do not tie EN to V <sub>DD</sub> .
17	V <sub>IN</sub>	Supply voltage for the internal LDO. The V <sub>IN</sub> operating voltage range is from 4.6V to 60V. A ceramic capacitor from V <sub>IN</sub> to AGND is required for decoupling. The decoupling capacitor should be placed as close as possible to the supply pin.
18	I <sub>LIM</sub>	Current Limit Setting. Connect a resistor from this pin to the SW pin node to allow for accurate current limit sensing programming of the internal low-side power MOSFET.
19	V <sub>DD</sub>	Internal +5V Linear Regulator: V <sub>DD</sub> is the internal supply bus for the IC. Connect to an external 1 $\mu$ F bypass capacitor. When V <sub>IN</sub> is <5.5V, this regulator operates in drop-out mode. Connect V <sub>DD</sub> to V <sub>IN</sub> .
20	PV <sub>DD</sub>	A 5V supply input for the low-side N-channel MOSFET driver circuit, which can be tied to V <sub>DD</sub> externally. A 1 $\mu$ F ceramic capacitor from PV <sub>DD</sub> to PGND is recommended for decoupling.
24	FREQ	Switching Frequency Adjust pin. Connect this pin to V <sub>IN</sub> to operate at 680 kHz. Place a resistor divider network from V <sub>IN</sub> to the FREQ pin to program the switching frequency.

# MIC28511

## 4.0 FUNCTIONAL DESCRIPTION

The MIC28511 is an adaptive on-time synchronous buck regulator with integrated high-side and low-side MOSFETs suitable for high-input voltage to low-output voltage conversion applications. It is designed to operate over a wide input voltage range (4.6V to 60V), which is suitable for automotive and industrial applications. The output is adjustable with an external resistive divider. An adaptive on-time control scheme is employed to produce a constant switching frequency in continuous-conduction mode and reduced switching frequency in discontinuous-operation mode, improving light-load efficiency. Overcurrent protection is implemented by sensing low-side MOSFET's  $R_{DS(ON)}$ . The device features internal soft-start, enable, UVLO, and thermal shutdown.

### 4.1 Theory of Operation

As illustrated in the [Functional Block Diagram](#), the output voltage of the MIC28511 is sensed by the feedback (FB) pin via voltage dividers R1 and R2, and compared to a 0.8V reference voltage  $V_{REF}$  at the error comparator through a low-gain transconductance ( $g_M$ ) amplifier. If the feedback voltage decreases and the amplifier output is below 0.8V, then the error comparator will trigger the control logic and generate an ON-time period. The ON-time period length is predetermined by the fixed  $t_{ON}$  estimator circuitry:

#### EQUATION 4-1:

$$t_{ON(ESTIMATED)} = \frac{V_{OUT}}{V_{IN} \times f_{SW}}$$

Where:

$V_{OUT}$	Output Voltage
$V_{IN}$	Power Stage Input Voltage
$f_{SW}$	Switching Frequency

At the end of the ON-time period, the internal high-side driver turns off the high-side MOSFET and the low-side driver turns on the low-side MOSFET. The OFF-time period length depends upon the feedback voltage in most cases. When the feedback voltage decreases and the output of the  $g_M$  amplifier is below 0.8V, then the ON-time period is triggered and the OFF-time period ends. If the OFF-time period determined by the feedback voltage is less than the minimum OFF-time  $t_{OFF(MIN)}$ , which is about 200 ns (typical), the MIC28511 control logic will apply the  $t_{OFF(MIN)}$  instead. The  $t_{OFF(MIN)}$  is required to maintain enough energy in the boost capacitor ( $C_{BST}$ ) to drive the high-side MOSFET.

The maximum duty cycle is obtained from [Equation 4-2](#).

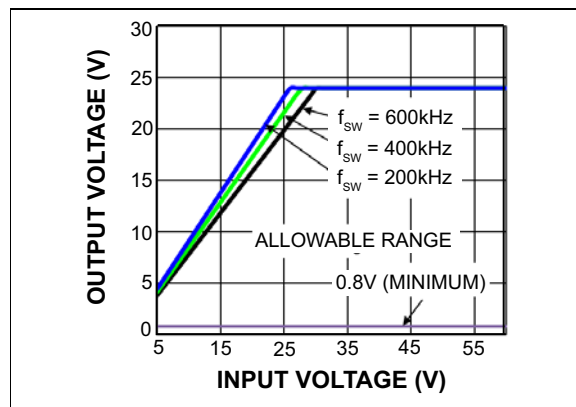
#### EQUATION 4-2:

$$D_{MAX} = 1 - t_{OFF(MIN)} \times f_{SW}$$

It is not recommended to use MIC28511 with an OFF-time close to  $t_{OFF(MIN)}$  during steady-state operation.

The adaptive ON-time control scheme results in a constant switching frequency in the MIC28511. The actual ON-time and resulting switching frequency will vary with the different rising and falling times of the external MOSFETs. Also, the minimum  $t_{ON}$  results in a lower switching frequency in high  $V_{IN}$  to  $V_{OUT}$  applications. During load transients, the switching frequency is changed due to the varying OFF-time.

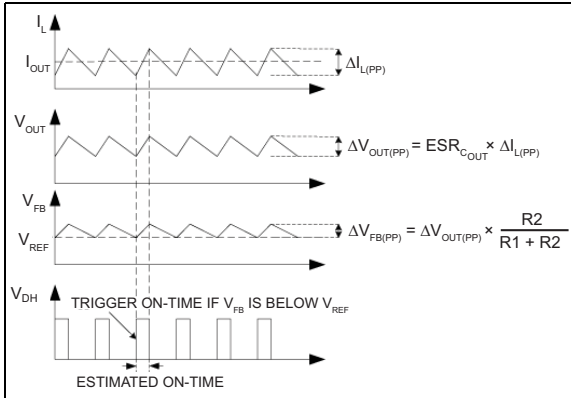
[Figure 4-1](#) shows the allowable range of the output voltage versus the input voltage. The minimum output voltage is 0.8V, which is limited by the reference voltage. The maximum output voltage is 24V, which is limited by the internal circuitry.



**FIGURE 4-1:** Allowable Output Voltage Range vs. Input Voltage.

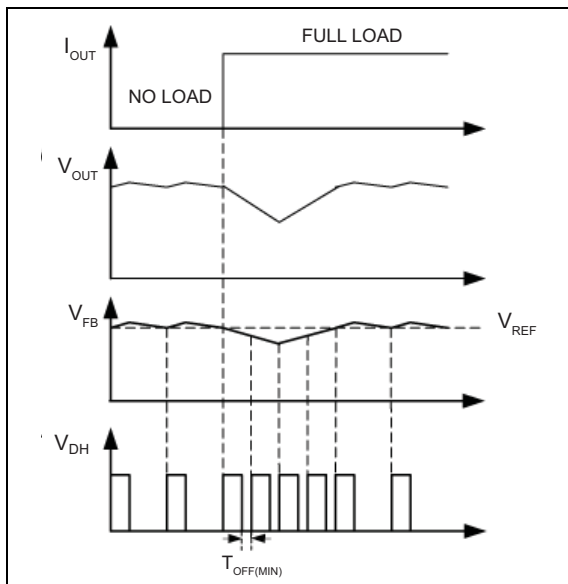
To illustrate the control loop operation, both the steady-state and load transient scenarios will be analyzed.

[Figure 4-2](#) shows the MIC28511 control loop timing during steady-state operation. During steady-state, the  $g_M$  amplifier senses the feedback voltage ripple, which is proportional to the output voltage ripple and the inductor current ripple, to trigger the ON-time period. The ON-time is predetermined by the  $t_{ON}$  estimator. The termination of the OFF-time is controlled by the feedback voltage. At the valley of the feedback voltage ripple, which occurs when  $V_{FB}$  falls below  $V_{REF}$ , the OFF period ends and the next ON-time period is triggered through the control logic circuitry.



**FIGURE 4-2:** MIC28511 Control Loop Timing.

Figure 4-3 shows the operation of the MIC28511 during a load transient. The output voltage drops due to the sudden load increase, which causes the  $V_{FB}$  to be less than  $V_{REF}$ . This will cause the error comparator to trigger an ON-time period. At the end of the ON-time period, a minimum OFF-time  $t_{OFF(MIN)}$  is generated to charge  $C_{BST}$  because the feedback voltage is still below  $V_{REF}$ . Then, the next ON-time period is triggered due to the low feedback voltage. Therefore, the switching frequency changes during the load transient, but returns to the nominal fixed frequency once the output has stabilized at the new load current level. With the varying duty cycle and switching frequency, the output recovery time is fast and the output voltage deviation is small in MIC28511 converter.



**FIGURE 4-3:** MIC28511 Load Transient Response.

Unlike true current-mode control, the MIC28511 uses the output voltage ripple to trigger an ON-time period. The output voltage ripple is proportional to the inductor

current ripple if the ESR of the output capacitor is large enough. The MIC28511 control loop has the advantage of eliminating the need for slope compensation.

In order to meet the stability requirements, the MIC28511 feedback voltage ripple should be in phase with the inductor current ripple and large enough to be sensed by the  $g_M$  amplifier and the error comparator. The recommended feedback voltage ripple is 20 mV ~ 100 mV.

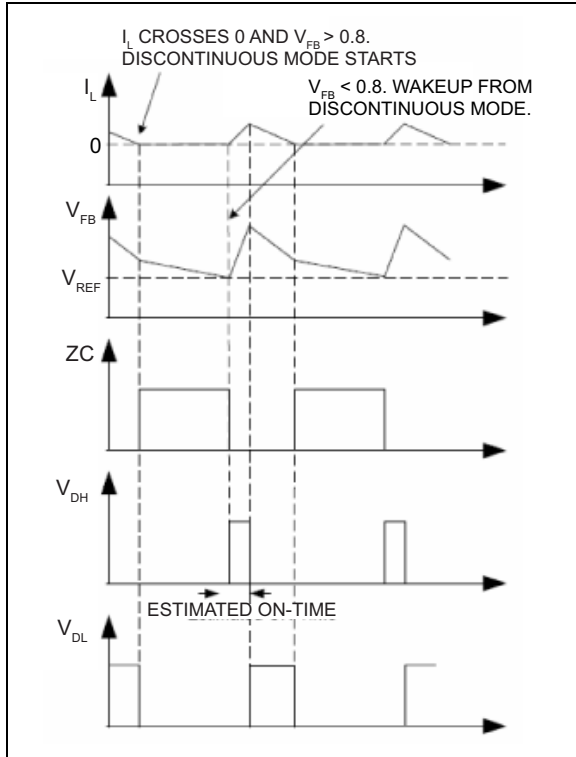
If a low-ESR output capacitor is selected, then the feedback voltage ripple may be too small to be sensed by the  $g_M$  amplifier and the error comparator. Also, if the ESR of the output capacitor is very low, the output voltage ripple and the feedback voltage ripple are not necessarily in phase with the inductor current ripple. In these cases, ripple injection is required to ensure proper operation. Please refer to the [Ripple Injection](#) subsection for more details about the ripple injection technique.

## 4.2 Discontinuous Mode (MIC28511-1 Only)

In continuous mode, the inductor current is always greater than zero; however, at light loads the MIC28511-1 is able to force the inductor current to operate in discontinuous mode. Discontinuous mode occurs when the inductor current falls to zero, as indicated by trace ( $I_L$ ) shown in [Figure 4-4](#). During this period, the efficiency is optimized by shutting down all the non-essential circuits and minimizing the supply current. The MIC28511-1 wakes up and turns on the high-side MOSFET when the feedback voltage  $V_{FB}$  drops below 0.8V.

The MIC28511-1 has a zero crossing comparator that monitors the inductor current by sensing the voltage drop across the low-side MOSFET during its ON-time. If the  $V_{FB} > 0.8V$  and the inductor current goes slightly negative, then the MIC28511-1 automatically powers down most of the IC circuitry and goes into a low-power mode.

Once the MIC28511-1 goes into discontinuous mode, both DH and DL are low, which turns off the high-side and low-side MOSFETs. The load current is supplied by the output capacitors and  $V_{OUT}$  drops. If the drop of  $V_{OUT}$  causes  $V_{FB}$  to go below  $V_{REF}$ , then all the circuits will wake up into normal continuous mode. First, the bias currents of most circuits reduced during the discontinuous mode are restored, and then a  $t_{ON}$  pulse is triggered before the drivers are turned on to avoid any possible glitches. Finally, the high-side driver is turned on. [Figure 4-4](#) shows the control loop timing in discontinuous mode.



**FIGURE 4-4:** MIC28511-1 Control Loop Timing (Discontinuous Mode).

During discontinuous mode, the bias current of most circuits are reduced. As a result, the total power supply current during discontinuous mode is only about 450  $\mu$ A, allowing the MIC28511-1 to achieve high efficiency in light load applications.

### 4.3 V<sub>DD</sub> Regulator

The MIC28511 provides a 5V regulated V<sub>DD</sub> to bias internal circuitry for V<sub>IN</sub> ranging from 5.5V to 60V. When V<sub>IN</sub> is less than 5.5V, V<sub>DD</sub> should be tied to V<sub>IN</sub> pins to bypass the internal linear regulator.

### 4.4 Soft-Start

Soft-start reduces the power supply inrush current at startup by controlling the output voltage rise time while the output capacitor charges.

The MIC28511 implements an internal digital soft-start by ramping up the 0.8V reference voltage (V<sub>REF</sub>) from 0 to 100% in about 5 ms with 9.7 mV steps. This controls the output voltage rate of rise at turn on, minimizing inrush current and eliminating output voltage overshoot. Once the soft-start cycle ends, the related circuitry is disabled to reduce current consumption.

### 4.5 Current Limit

The MIC28511 uses the R<sub>DS(ON)</sub> of the internal low-side power MOSFET to sense overcurrent conditions. In each switching cycle, the inductor current is sensed by monitoring the low-side MOSFET during its ON period. The sensed voltage, V<sub>(ILIM)</sub>, is compared with the power ground (PGND) after a blanking time of 150 ns.

The voltage drop of the resistor R<sub>ILIM</sub> is compared with the low-side MOSFET voltage drop to set the overcurrent trip level. The small capacitor connected from the I<sub>LIM</sub> pin to PGND can be added to filter the switching node ringing, allowing a better short limit measurement. The time constant created by R<sub>ILIM</sub> and the filter capacitor should be much less than the minimum off time.

The overcurrent limit can be programmed by using Equation 4-3:

#### EQUATION 4-3:

$$R_{ILIM} = \frac{(I_{CLIM} + 0.5 \times \Delta I_{L(PP)}) \times R_{DS(ON)} + V_{CL}}{I_{CL}}$$

Where:

I <sub>CLIM</sub>	Desired Output Current Limit
$\Delta I_{L(PP)}$	Inductor Current Peak-to-Peak Use Equation 4-4 to calculate the inductor ripple current
R <sub>DS(ON)</sub>	On-Resistance of Low-Side Power MOSFET
V <sub>CL</sub>	Current-limit threshold. 14 mV (typical). See the Electrical Characteristics table.
I <sub>CL</sub>	Current-limit source current. 70 $\mu$ A (typical). See the Electrical Characteristics table.

The peak-to-peak inductor current ripple is calculated with Equation 4-4.

#### EQUATION 4-4:

$$\Delta I_{L(PP)} = \frac{V_{OUT} \times (V_{IN(MAX)} - V_{OUT})}{V_{IN(MAX)} \times f_{SW} \times L}$$

The MOSFET R<sub>DS(ON)</sub> varies 30% to 40% with temperature; therefore, it is recommended to use the R<sub>DS(ON)</sub> at maximum junction temperature with a 20% margin to calculate R<sub>ILIM</sub> in Equation 4-3.

In case of hard short, the current-limit threshold is folded down to allow an indefinite hard short on the output without any destructive effect. It is mandatory to make sure that the inductor current used to charge the output capacitor during soft-start is under the folded

short limit; otherwise the supply will go into hiccup mode and may not be finishing the soft-start successfully.

When operating at higher input voltages, it is recommended to look at the safe operating area (SOA) curves while selecting the output current limit threshold. SOA curves for MIC28511 are given through [Figure 2-19](#) and [Figure 2-20](#) in [Section 2.0, Typical Performance Curves](#).

## 4.6 Output Current Thermal Derating

MIC28511 is packaged in 3 mm x 4 mm FQFN package. The output current derates with temperature when operated with higher input voltage at higher temperature as shown in typical operating curves in [Figure 2-19](#) and [Figure 2-20](#) for MIC28511-1, and [Figure 2-34](#) and [Figure 2-35](#) for MIC28511-2.

## 4.7 Power Good (PGOOD)

The power good (PGOOD) pin is an open-drain output that indicates logic-high when the output is nominally 90% of its steady state voltage.

## 4.8 MOSFET Gate Drive

The [Functional Block Diagram](#) shows a bootstrap circuit, consisting of  $D_{BST}$ ,  $C_{BST}$ , and  $R_{BST}$ . This circuit supplies energy to the high-side drive circuit. Capacitor  $C_{BST}$  is charged, while the low-side MOSFET is on, and the voltage on the SW pin is approximately 0V. When the high-side MOSFET driver is turned on, energy from  $C_{BST}$  is used to turn the MOSFET on. As the high-side MOSFET turns on, the voltage on the SW pin increases to approximately  $V_{IN}$ . Diode  $D_{BST}$  is reverse-biased and  $C_{BST}$  floats high while continuing to bias the high-side gate driver. The bias current of the high-side driver is less than 10 mA, so a 0.1  $\mu$ F to 1  $\mu$ F capacitor is sufficient to hold the gate voltage with minimal droop for the power stroke (high-side switching) cycle, i.e.

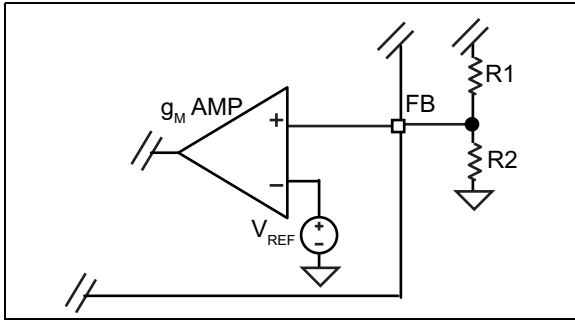
$\Delta_{BST} = 10 \text{ mA} \times 1.25 \mu\text{s} / 0.1 \mu\text{F} = 125 \text{ mV}$ . When the low-side MOSFET is turned back on,  $C_{BST}$  is then recharged through the boost diode. A 30 $\Omega$  resistor  $R_{BST}$ , which is in series with the BST pin, is required to slow down the turn-on time of the high-side N-channel MOSFET.

# MIC28511

## 5.0 APPLICATION INFORMATION

### 5.1 Output Voltage Setting Components

The MIC28511 requires two resistors to set the output voltage as shown in Figure 5-1.



**FIGURE 5-1:** Voltage Divider Configuration.

The output voltage is determined by Equation 5-1.

#### EQUATION 5-1:

$$V_{OUT} = V_{FB} \times \left(1 + \frac{R1}{R2}\right)$$

Where:

$$V_{FB} = 0.8V$$

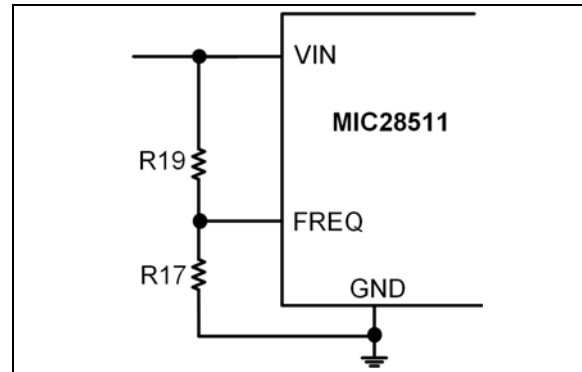
A typical value of R1 used on the standard evaluation board is 10 kΩ. If R1 is too large, it may allow noise to be introduced into the voltage feedback loop. If R1 is too small in value, it will decrease the efficiency of the buck converter, especially at light loads. Once R1 is selected, R2 can be calculated using Equation 5-2:

#### EQUATION 5-2:

$$R2 = \frac{V_{FB} \times R1}{V_{OUT} - V_{FB}}$$

### 5.2 Setting the Switching Frequency

The MIC28511 switching frequency can be adjusted by changing the resistor divider network from V<sub>IN</sub>.



**FIGURE 5-2:** Switching Frequency Adjustment.

Equation 5-3 gives the estimated switching frequency.

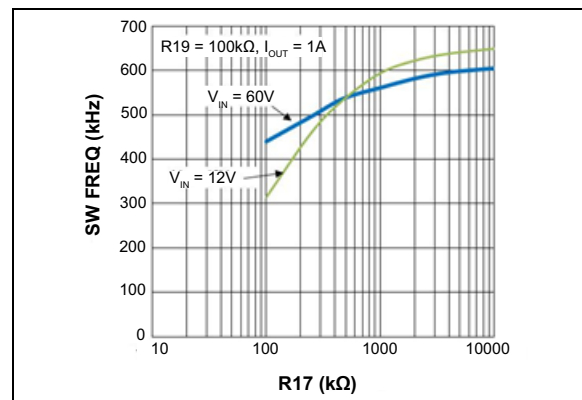
#### EQUATION 5-3:

$$f_{SW} = f_0 \times \left(\frac{R17}{R17 + R19}\right)$$

Where:

$$f_0 = \text{Switching frequency when R17 is open; typically 680 kHz.}$$

Figure 5-3 shows the switching frequency versus the resistor R17 when R19 = 100 kΩ.



**FIGURE 5-3:** Switching Frequency vs. R17.

### 5.3 Inductor Selection

Values for inductance, peak and RMS currents are required to select the output inductor. The input and output voltages and the inductance value determine the peak-to-peak inductor ripple current. Generally, higher inductance values are used with higher input voltages. Larger peak-to-peak ripple currents will increase the power dissipation in the inductor and

MOSFETs. Larger output ripple currents will also require more output capacitance to smooth out the larger ripple current. Smaller peak-to-peak ripple currents require a larger inductance value and therefore a larger and more expensive inductor. A good compromise between size, loss and cost is to set the inductor ripple current to be equal to 20% of the maximum output current. The inductance value is calculated by:

#### EQUATION 5-4:

$$L = \frac{V_{OUT} \times (V_{IN(MAX)} - V_{OUT})}{V_{IN(MAX)} \times \Delta I_{L(PP)} \times f_{SW}}$$

Where:

$f_{SW}$	Switching Frequency
$\Delta I_{L(PP)}$	The peak-to-peak inductor current ripple; typically 20% of the maximum output current

In continuous conduction mode, the peak inductor current is equal to the average output current plus one half of the peak-to-peak inductor current ripple.

#### EQUATION 5-5:

$$I_{L(PK)} = I_{OUT} + 0.5 \times \Delta I_{L(PP)}$$

The RMS inductor current is used to calculate the  $I^2R$  losses in the inductor.

#### EQUATION 5-6:

$$I_{L(RMS)} = \sqrt{I_{OUT(MAX)}^2 + \frac{\Delta I_{L(PP)}^2}{12}}$$

Maximizing efficiency requires the proper selection of core material and minimizing the winding resistance. The high-frequency operation of the MIC28511 requires the use of ferrite materials for all but the most cost-sensitive applications. Lower-cost iron powder cores may be used but the increase in core loss will reduce the efficiency of the buck converter. This is especially noticeable at low output power. The winding resistance decreases efficiency at the higher output current levels.

The winding resistance must be minimized although this usually comes at the expense of a larger inductor. The power dissipated in the inductor is equal to the sum of the core and copper losses. At higher output loads, the core losses are usually insignificant and can be ignored. At lower output currents, the core losses can be a significant contributor. Core loss information is usually available from the magnetics vendor. Copper loss in the inductor is calculated by [Equation 5-7](#):

#### EQUATION 5-7:

$$P_{L(CU)} = I_{L(RMS)}^2 \times DCR$$

The resistance of the copper wire, DCR, increases with the temperature. The value of the winding resistance used should be at the operating temperature.

#### EQUATION 5-8:

$$DCR_{(HT)} = DCR_{(20C)} \times (1 + 0.0042 \times [T_H - T_{20C}])$$

Where:

$T_H$	Temperature of wire under full load
$T_{20C}$	Ambient temperature
$DCR_{(20C)}$	Room temperature winding resistance (usually specified by the manufacturer)

## 5.4 Output Capacitor Selection

The type of the output capacitor is usually determined by its equivalent series resistance (ESR). Voltage and RMS current capability are also important factors in selecting an output capacitor. Recommended capacitor types are ceramic, tantalum, low-ESR aluminum electrolytic, OS-CON and POSCAP. For high ESR electrolytic capacitors, ESR is the main cause of the output ripple. The output capacitor ESR also affects the control loop from a stability point of view. For a low ESR ceramic output capacitor, ripple is dominated by the reactive impedance. The maximum value of ESR is calculated by [Equation 5-9](#).

#### EQUATION 5-9:

$$ESR_{COUT} \leq \frac{\Delta V_{OUT(PP)}}{\Delta I_{L(PP)}}$$

Where:

$\Delta V_{OUT(PP)}$	Peak-to-Peak Output Voltage Ripple
$\Delta I_{L(PP)}$	Peak-to-Peak Inductor Current Ripple

The total output ripple is a combination of voltage ripples caused by the ESR and output capacitance. The total ripple is calculated by [Equation 5-10](#).

#### EQUATION 5-10:

$$\Delta V_{OUT(PP)} = \sqrt{\left(\frac{\Delta I_{L(PP)}}{C_{OUT} \times f_{SW} \times 8}\right)^2 + (\Delta I_{L(PP)} \times ESR_{COUT})^2}$$

Where:

$C_{OUT}$	Output Capacitance Value
$f_{SW}$	Switching Frequency

# MIC28511

As described in the [Theory of Operation](#) subsection of the [Functional Description](#), the MIC28511 requires at least 20 mV peak-to-peak ripple at the FB pin for the  $g_M$  amplifier and the error comparator to operate properly. Also, the ripple on FB pin should be in phase with the inductor current. Therefore, the output voltage ripple caused by the output capacitors value should be much smaller than the ripple caused by the output capacitor ESR. If low-ESR capacitors, such as ceramic capacitors, are selected as the output capacitors, a ripple injection method should be applied to provide the enough feedback voltage ripple. Refer to the [Ripple Injection](#) subsection for details.

The voltage rating of the capacitor should be twice the output voltage for a tantalum and 20% greater for aluminum electrolytic or OS-CON. The output capacitor RMS current is calculated in [Equation 5-11](#).

## EQUATION 5-11:

$$I_{C_{OUT}(RMS)} = \frac{\Delta I_{L(PP)}}{\sqrt{12}}$$

The power dissipated in the output capacitor is:

## EQUATION 5-12:

$$P_{DISS(COUT)} = I_{COUT(RMS)}^2 \times ESR_{COUT}$$

## 5.5 Input Capacitor Selection

The input capacitor for the power stage input  $V_{IN}$  should be selected for ripple current rating and voltage rating. Tantalum input capacitors may fail when subjected to high inrush currents, caused by turning the input supply on. A tantalum input capacitor's voltage rating should be at least two times the maximum input voltage to maximize reliability. Aluminum electrolytic, OS-CON, and multilayer polymer film capacitors can handle the higher inrush currents without voltage de-rating. The input voltage ripple will primarily depend on the input capacitor's ESR. The peak input current is equal to the peak inductor current, so:

## EQUATION 5-13:

$$\Delta V_{IN} = I_{L(PK)} \times ESR_{CIN}$$

The input capacitor must be rated for the input current ripple. The RMS value of input capacitor current is determined at the maximum output current. Assuming the peak-to-peak inductor current ripple is low:

## EQUATION 5-14:

$$I_{CIN(RMS)} \approx I_{OUT(MAX)} \times \sqrt{D \times (1 - D)}$$

The power dissipated in the input capacitor is:

## EQUATION 5-15:

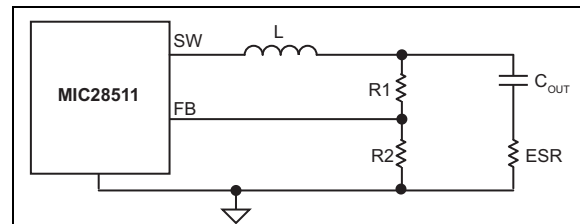
$$P_{DISS(CIN)} = I_{CIN(RMS)}^2 \times ESR_{CIN}$$

## 5.6 Ripple Injection

The  $V_{FB}$  ripple required for proper operation of the MIC28511's  $g_M$  amplifier and error comparator is 20 mV to 100 mV. However, the output voltage ripple is generally designed as 1% to 2% of the output voltage. If the feedback voltage ripple is so small that the  $g_M$  amplifier and error comparator can't sense it, then the MIC28511 will lose control and the output voltage is not regulated. In order to have some amount of  $V_{FB}$  ripple, a ripple injection method is applied for low output voltage ripple applications.

The applications are divided into three situations according to the amount of the feedback voltage ripple:

- Enough ripple at the feedback voltage due to the large ESR of the output capacitors ([Figure 5-4](#)). The converter is stable without any ripple injection.



**FIGURE 5-4:** Enough Ripple at FB.

The feedback voltage ripple is:

## EQUATION 5-16:

$$\Delta V_{FB(PP)} = \frac{R2}{R1 + R2} \times ESR_{COUT} \times \Delta I_{L(PP)}$$

Where:

$\Delta I_{L(PP)}$  Peak-to-Peak Value of the Inductor Current Ripple

- Inadequate ripple at the feedback voltage due to the small ESR of the output capacitors.

The output voltage ripple is fed into the FB pin through a feed-forward capacitor,  $C_{FF}$  in this situation, as shown in [Figure 5-5](#). The typical  $C_{FF}$  value is selected by using [Equation 5-17](#).



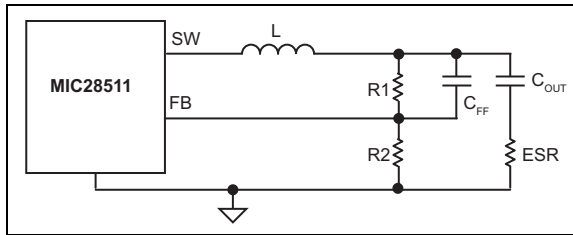
## EQUATION 5-17:

$$R1 \times C_{FF} \approx \frac{10}{f_{SW}}$$

With the feed-forward capacitor, the feedback voltage ripple is very close to the output voltage ripple.

## EQUATION 5-18:

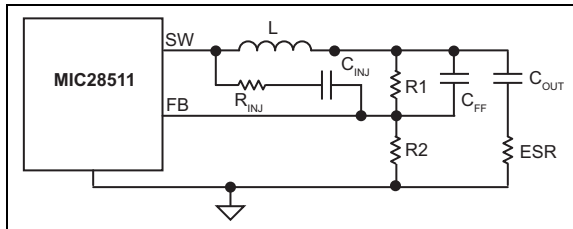
$$\Delta V_{FB(PP)} \approx ESR \times \Delta I_{L(PP)}$$



**FIGURE 5-5:** Inadequate Ripple at FB.

- Virtually no ripple at the FB pin voltage due to the very low ESR of the output capacitors.

In this situation, the output voltage ripple is less than 20 mV. Therefore, additional ripple is injected into the FB pin from the switching node SW via a resistor  $R_{INJ}$  and a capacitor  $C_{INJ}$ , as shown in Figure 5-6.



**FIGURE 5-6:** Invisible Ripple at FB.

The injected ripple is calculated via:

## EQUATION 5-19:

$$\Delta V_{FB(PP)} = V_{IN} \times K_{div} \times D \times (1 - D) \times \frac{1}{f_{SW} \times \tau}$$

Where:

$V_{IN}$	Power stage input voltage
$D$	Duty cycle
$f_{SW}$	Switching frequency
$\tau$	$(R1//R2//R_{INJ}) \times C_{FF}$

## EQUATION 5-20:

$$K_{div} = \frac{R1//R2}{R_{INJ} + R1//R2}$$

In Equation 5-19 and Equation 5-20, it is assumed that the time constant associated with  $C_{FF}$  must be much greater than the switching period:

## EQUATION 5-21:

$$\frac{1}{f_{SW} \times \tau} = \frac{T}{\tau} \ll 1$$

If the voltage divider resistors  $R1$  and  $R2$  are in the  $k\Omega$  range, a  $C_{FF}$  of 1 nF to 100 nF can easily satisfy the large time constant requirements. Also, a 100 nF injection capacitor  $C_{INJ}$  is used in order to be considered as short for a wide range of the frequencies.

The process of sizing the ripple injection resistor and capacitors is as follows.

- Select  $C_{FF}$  to feed all output ripples into the feedback pin and make sure the large time constant assumption is satisfied. Typical choice of  $C_{FF}$  is 1 nF to 100 nF if  $R1$  and  $R2$  are in the  $k\Omega$  range.
- Select  $R_{INJ}$  according to the expected feedback voltage ripple using Equation 5-22:

## EQUATION 5-22:

$$K_{div} = \frac{\Delta V_{FB(PP)}}{V_{IN}} \times \frac{f_{SW} \times \tau}{D \times (1 - D)}$$

The value of  $R_{INJ}$  is calculated using Equation 5-23.

## EQUATION 5-23:

$$R_{INJ} = (R1//R2) \times \left( \frac{1}{K_{div}} - 1 \right)$$

- Select  $C_{INJ}$  as 100 nF, which could be considered as short for a wide range of the frequencies.

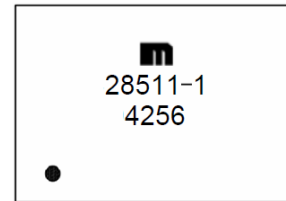
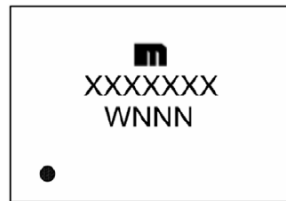


## 7.0 PACKAGING INFORMATION

### 7.1 Package Marking Information

24-lead FQFN (3 x 4 mm)

Example



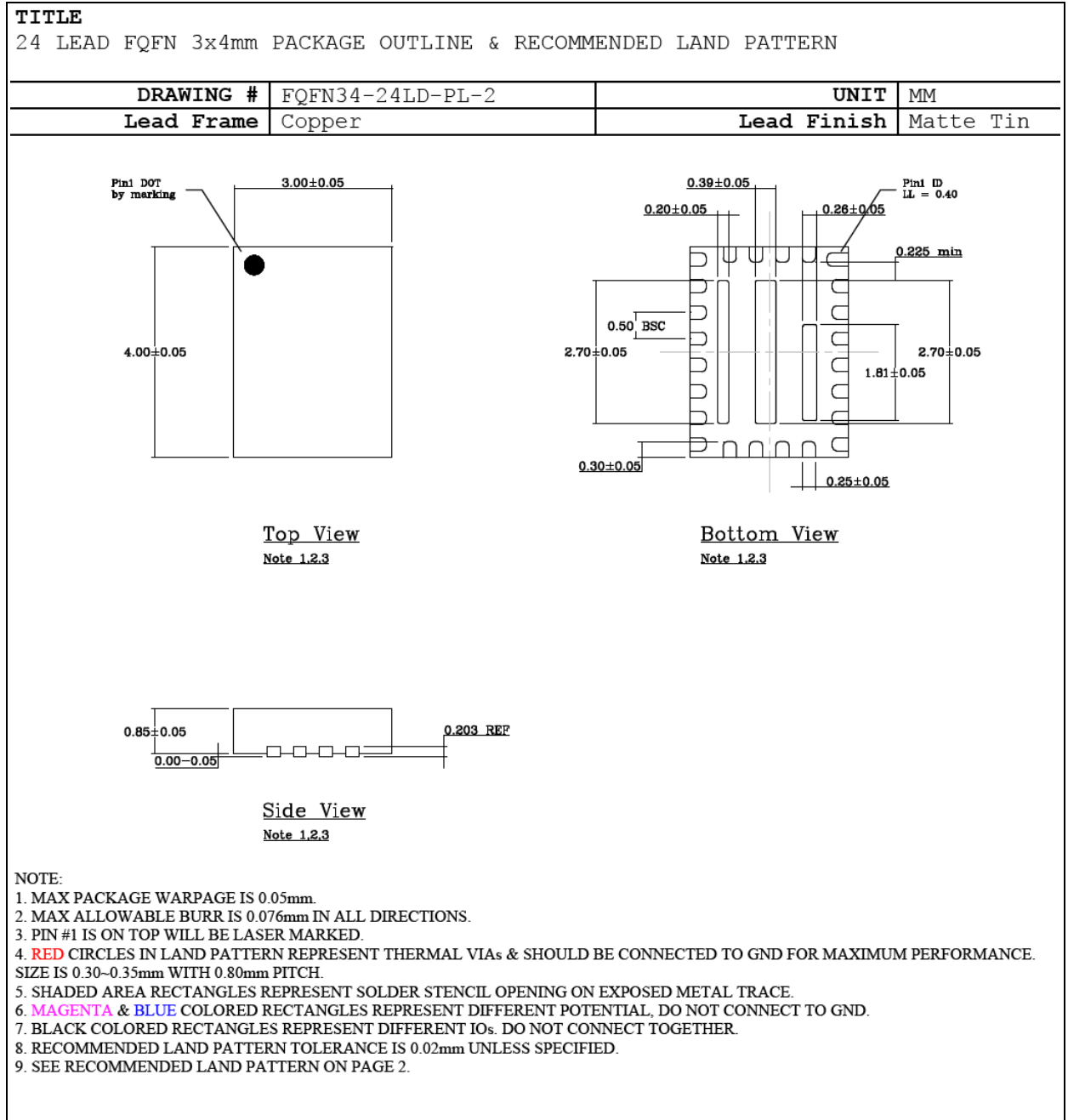
<b>Legend:</b>	XX...X	Customer-specific information
	Y	Year code (last digit of calendar year)
	YY	Year code (last 2 digits of calendar year)
	WW	Week code (week of January 1 is week '01')
	NNN	Alphanumeric traceability code
	(e3)	Pb-free JEDEC® designator for Matte Tin (Sn)
	*	This package is Pb-free. The Pb-free JEDEC designator (e3) can be found on the outer packaging for this package.

**Note:** In the event the full Microchip part number cannot be marked on one line, it will be carried over to the next line, thus limiting the number of available characters for customer-specific information.

# MIC28511

## 24-Lead QFN 3 mm x 4 mm Package Outline and Recommended Land Pattern

**Note:** For the most current package drawings, please see the Microchip Packaging Specification located at <http://www.microchip.com/packaging>

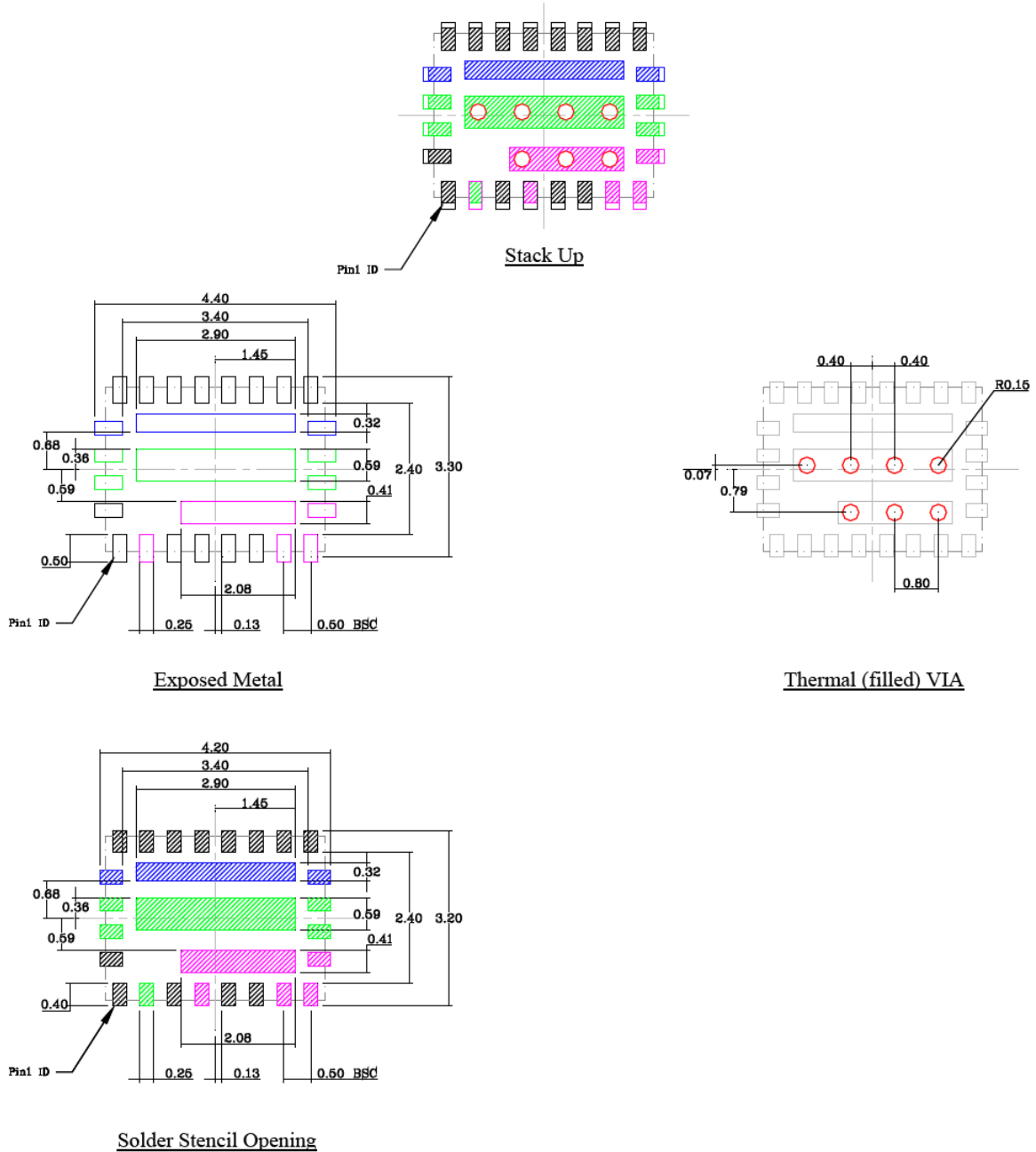


**Note:** For the most current package drawings, please see the Microchip Packaging Specification located at <http://www.microchip.com/packaging>

POD-Land Pattern Doc #: FQFN34-24LD-PL-2-E

## Recommended Land Pattern

Note: 4,5,6,7





## APPENDIX A: REVISION HISTORY

### Revision B (November 2017)

The following is the list of modifications:

- Updated [Absolute Maximum Ratings †](#).
- Updated [Figure 2-22](#), [Equation 4-3](#) and [Equation 5-10](#).
- Updated [Section 4.5, Current Limit](#).
- Added [Section 4.6, Output Current Thermal Derating](#).
- Various typographical edits.

### Revision A (May 2016)

- Converted Micrel document MIC28511 to Microchip data sheet template DS20005520A.
- Minor text changes throughout.

# MIC28511

---

NOTES:



## PRODUCT IDENTIFICATION SYSTEM

To order or obtain information, e.g., on pricing or delivery, contact your local Microchip representative or sales office.

<u>PART NO.</u>		X	X	XX
Device	Architecture	Temperature	Package	
<b>Device:</b>	MIC28511:	60V <sub>IN</sub> , 3A Synchronous Buck Regulator		
<b>Architecture:</b>	1 =	HyperLight Load		
	2 =	Hyper Speed Control		
<b>Temperature:</b>	Y =	-40°C to +125°C		
<b>Package:</b>	FL =	24-Pin 3 mm x 4 mm QFN; <a href="#">Note 1</a>		

**Examples:**

a) MIC28511-1YFL: 60V<sub>IN</sub>, 3A Synchronous Buck Regulator, HyperLight Load, -40°C to +125°C Junction Temperature Range, 24LD QFN

b) MIC28511-2YFL: 60V<sub>IN</sub>, 3A Synchronous Buck Regulator, Hyper Speed Control, -40°C to +125°C Junction Temperature Range, 24LD QFN

**Note 1:** QFN is a lead-free package. Pb-Free lead finish is Matte Tin.

# MIC28511

---

NOTES:

---

**Note the following details of the code protection feature on Microchip devices:**

- Microchip products meet the specification contained in their particular Microchip Data Sheet.
- Microchip believes that its family of products is one of the most secure families of its kind on the market today, when used in the intended manner and under normal conditions.
- There are dishonest and possibly illegal methods used to breach the code protection feature. All of these methods, to our knowledge, require using the Microchip products in a manner outside the operating specifications contained in Microchip's Data Sheets. Most likely, the person doing so is engaged in theft of intellectual property.
- Microchip is willing to work with the customer who is concerned about the integrity of their code.
- Neither Microchip nor any other semiconductor manufacturer can guarantee the security of their code. Code protection does not mean that we are guaranteeing the product as “unbreakable.”

Code protection is constantly evolving. We at Microchip are committed to continuously improving the code protection features of our products. Attempts to break Microchip's code protection feature may be a violation of the Digital Millennium Copyright Act. If such acts allow unauthorized access to your software or other copyrighted work, you may have a right to sue for relief under that Act.

---

Information contained in this publication regarding device applications and the like is provided only for your convenience and may be superseded by updates. It is your responsibility to ensure that your application meets with your specifications. MICROCHIP MAKES NO REPRESENTATIONS OR WARRANTIES OF ANY KIND WHETHER EXPRESS OR IMPLIED, WRITTEN OR ORAL, STATUTORY OR OTHERWISE, RELATED TO THE INFORMATION, INCLUDING BUT NOT LIMITED TO ITS CONDITION, QUALITY, PERFORMANCE, MERCHANTABILITY OR FITNESS FOR PURPOSE. Microchip disclaims all liability arising from this information and its use. Use of Microchip devices in life support and/or safety applications is entirely at the buyer's risk, and the buyer agrees to defend, indemnify and hold harmless Microchip from any and all damages, claims, suits, or expenses resulting from such use. No licenses are conveyed, implicitly or otherwise, under any Microchip intellectual property rights unless otherwise stated.

*Microchip received ISO/TS-16949:2009 certification for its worldwide headquarters, design and wafer fabrication facilities in Chandler and Tempe, Arizona; Gresham, Oregon and design centers in California and India. The Company's quality system processes and procedures are for its PIC® MCUs and dsPIC® DSCs, KEELoC® code hopping devices, Serial EEPROMs, microperipherals, nonvolatile memory and analog products. In addition, Microchip's quality system for the design and manufacture of development systems is ISO 9001:2000 certified.*

**QUALITY MANAGEMENT SYSTEM  
CERTIFIED BY DNV  
= ISO/TS 16949 =**

### Trademarks

The Microchip name and logo, the Microchip logo, AnyRate, AVR, AVR logo, AVR Freaks, BeaconThings, BitCloud, CryptoMemory, CryptoRF, dsPIC, FlashFlex, flexPWR, Heldo, JukeBlox, KEELoC, KEELoC logo, Klear, LANCheck, LINK MD, maXStylus, maXTouch, MediaLB, megaAVR, MOST, MOST logo, MPLAB, OptoLyzer, PIC, picoPower, PICSTART, PIC32 logo, Prochip Designer, QTouch, RightTouch, SAM-BA, SpyNIC, SST, SST Logo, SuperFlash, tinyAVR, UNI/O, and XMEGA are registered trademarks of Microchip Technology Incorporated in the U.S.A. and other countries.

ClockWorks, The Embedded Control Solutions Company, EtherSynch, Hyper Speed Control, HyperLight Load, IntelliMOS, mTouch, Precision Edge, and Quiet-Wire are registered trademarks of Microchip Technology Incorporated in the U.S.A.

Adjacent Key Suppression, AKS, Analog-for-the-Digital Age, Any Capacitor, AnyIn, AnyOut, BodyCom, chipKIT, chipKIT logo, CodeGuard, CryptoAuthentication, CryptoCompanion, CryptoController, dsPICDEM, dsPICDEM.net, Dynamic Average Matching, DAM, ECAN, EtherGREEN, In-Circuit Serial Programming, ICSP, Inter-Chip Connectivity, JitterBlocker, KlearNet, KlearNet logo, Mindi, MiWi, motorBench, MPASM, MPF, MPLAB Certified logo, MPLIB, MPLINK, MultiTRAK, NetDetach, Omniscient Code Generation, PICDEM, PICDEM.net, PICKit, PICtail, PureSilicon, QMatrix, RightTouch logo, REAL ICE, Ripple Blocker, SAM-ICE, Serial Quad I/O, SMART-I.S., SQI, SuperSwitcher, SuperSwitcher II, Total Endurance, TSHARC, USBCheck, VariSense, ViewSpan, WiperLock, Wireless DNA, and ZENA are trademarks of Microchip Technology Incorporated in the U.S.A. and other countries.

SQTP is a service mark of Microchip Technology Incorporated in the U.S.A.

Silicon Storage Technology is a registered trademark of Microchip Technology Inc. in other countries.

GestIC is a registered trademark of Microchip Technology Germany II GmbH & Co. KG, a subsidiary of Microchip Technology Inc., in other countries.

All other trademarks mentioned herein are property of their respective companies.

© 2016-2017, Microchip Technology Incorporated, All Rights Reserved.

ISBN: 978-1-5224-2403-1



# MICROCHIP

## Worldwide Sales and Service

### AMERICAS

**Corporate Office**  
2355 West Chandler Blvd.  
Chandler, AZ 85224-6199  
Tel: 480-792-7200  
Fax: 480-792-7277  
Technical Support:  
<http://www.microchip.com/support>  
Web Address:  
[www.microchip.com](http://www.microchip.com)

**Atlanta**  
Duluth, GA  
Tel: 678-957-9614  
Fax: 678-957-1455

**Austin, TX**  
Tel: 512-257-3370

**Boston**  
Westborough, MA  
Tel: 774-760-0087  
Fax: 774-760-0088

**Chicago**  
Itasca, IL  
Tel: 630-285-0071  
Fax: 630-285-0075

**Dallas**  
Addison, TX  
Tel: 972-818-7423  
Fax: 972-818-2924

**Detroit**  
Novi, MI  
Tel: 248-848-4000

**Houston, TX**  
Tel: 281-894-5983

**Indianapolis**  
Noblesville, IN  
Tel: 317-773-8323  
Fax: 317-773-5453  
Tel: 317-536-2380

**Los Angeles**  
Mission Viejo, CA  
Tel: 949-462-9523  
Fax: 949-462-9608  
Tel: 951-273-7800

**Raleigh, NC**  
Tel: 919-844-7510

**New York, NY**  
Tel: 631-435-6000

**San Jose, CA**  
Tel: 408-735-9110  
Tel: 408-436-4270

**Canada - Toronto**  
Tel: 905-695-1980  
Fax: 905-695-2078

### ASIA/PACIFIC

**Australia - Sydney**  
Tel: 61-2-9868-6733

**China - Beijing**  
Tel: 86-10-8569-7000

**China - Chengdu**  
Tel: 86-28-8665-5511

**China - Chongqing**  
Tel: 86-23-8980-9588

**China - Dongguan**  
Tel: 86-769-8702-9880

**China - Guangzhou**  
Tel: 86-20-8755-8029

**China - Hangzhou**  
Tel: 86-571-8792-8115

**China - Hong Kong SAR**  
Tel: 852-2943-5100

**China - Nanjing**  
Tel: 86-25-8473-2460

**China - Qingdao**  
Tel: 86-532-8502-7355

**China - Shanghai**  
Tel: 86-21-3326-8000

**China - Shenyang**  
Tel: 86-24-2334-2829

**China - Shenzhen**  
Tel: 86-755-8864-2200

**China - Suzhou**  
Tel: 86-186-6233-1526

**China - Wuhan**  
Tel: 86-27-5980-5300

**China - Xian**  
Tel: 86-29-8833-7252

**China - Xiamen**  
Tel: 86-592-2388138

**China - Zhuhai**  
Tel: 86-756-3210040

### ASIA/PACIFIC

**India - Bangalore**  
Tel: 91-80-3090-4444

**India - New Delhi**  
Tel: 91-11-4160-8631

**India - Pune**  
Tel: 91-20-4121-0141

**Japan - Osaka**  
Tel: 81-6-6152-7160

**Japan - Tokyo**  
Tel: 81-3-6880-3770

**Korea - Daegu**  
Tel: 82-53-744-4301

**Korea - Seoul**  
Tel: 82-2-554-7200

**Malaysia - Kuala Lumpur**  
Tel: 60-3-7651-7906

**Malaysia - Penang**  
Tel: 60-4-227-8870

**Philippines - Manila**  
Tel: 63-2-634-9065

**Singapore**  
Tel: 65-6334-8870

**Taiwan - Hsin Chu**  
Tel: 886-3-577-8366

**Taiwan - Kaohsiung**  
Tel: 886-7-213-7830

**Taiwan - Taipei**  
Tel: 886-2-2508-8600

**Thailand - Bangkok**  
Tel: 66-2-694-1351

**Vietnam - Ho Chi Minh**  
Tel: 84-28-5448-2100

### EUROPE

**Austria - Wels**  
Tel: 43-7242-2244-39  
Fax: 43-7242-2244-393

**Denmark - Copenhagen**  
Tel: 45-4450-2828  
Fax: 45-4485-2829

**Finland - Espoo**  
Tel: 358-9-4520-820

**France - Paris**  
Tel: 33-1-69-53-63-20  
Fax: 33-1-69-30-90-79

**Germany - Garching**  
Tel: 49-8931-9700

**Germany - Haan**  
Tel: 49-2129-3766400

**Germany - Heilbronn**  
Tel: 49-7131-67-3636

**Germany - Karlsruhe**  
Tel: 49-721-625370

**Germany - Munich**  
Tel: 49-89-627-144-0  
Fax: 49-89-627-144-44

**Germany - Rosenheim**  
Tel: 49-8031-354-560

**Israel - Ra'anana**  
Tel: 972-9-744-7705

**Italy - Milan**  
Tel: 39-0331-742611  
Fax: 39-0331-466781

**Italy - Padova**  
Tel: 39-049-7625286

**Netherlands - Drunen**  
Tel: 31-416-690399  
Fax: 31-416-690340

**Norway - Trondheim**  
Tel: 47-7289-7561

**Poland - Warsaw**  
Tel: 48-22-3325737

**Romania - Bucharest**  
Tel: 40-21-407-87-50

**Spain - Madrid**  
Tel: 34-91-708-08-90  
Fax: 34-91-708-08-91

**Sweden - Gothenberg**  
Tel: 46-31-704-60-40

**Sweden - Stockholm**  
Tel: 46-8-5090-4654

**UK - Wokingham**  
Tel: 44-118-921-5800  
Fax: 44-118-921-5820

## X-ON Electronics

Largest Supplier of Electrical and Electronic Components

*Click to view similar products for [Switching Voltage Regulators](#) category:*

*Click to view products by [Microchip](#) manufacturer:*

Other Similar products are found below :

[FAN53610AUC33X](#) [FAN53611AUC123X](#) [FAN48610BUC33X](#) [FAN48610BUC45X](#) [FAN48617UC50X](#) [R3](#) [430464BB](#) [MIC45116-1YMP-T1](#) [KE177614](#) [MAX809TTR](#) [NCV891234MW50R2G](#) [NCP81103MNTXG](#) [NCP81203PMNTXG](#) [NCP81208MNTXG](#) [NCP81109GMNTXG](#) [SCY1751FCCT1G](#) [NCP81109JMNTXG](#) [AP3409ADNTR-G1](#) [LTM8064IY](#) [LT8315EFE#TRPBF](#) [NCV1077CSTBT3G](#) [XCL207A123CR-G](#) [MPM54304GMN-0002](#) [MPM54304GMN-0003](#) [XDPE132G5CG000XUMA1](#) [DA9121-B0V76](#) [LTC3644IY#PBF](#) [MP8757GL-P](#) [MIC23356YFT-TR](#) [LD8116CGL](#) [HG2269M/TR](#) [OB2269](#) [XD3526](#) [U6215A](#) [U6215B](#) [U6620S](#) [LTC3803ES6#TR](#) [LTC3803ES6#TRM](#) [LTC3412IFE](#) [LT1425IS](#) [MAX25203BATJA/VY+](#) [MAX77874CEWM+](#) [XC9236D08CER-G](#) [ISL95338IRTZ](#) [MP3416GJ-P](#) [BD9S201NUX-CE2](#) [MP5461GC-Z](#) [MPQ4415AGQB-Z](#) [MPQ4590GS-Z](#) [MCP1603-330IMC](#)