



MIC29150/29300/29500/29750

High-Current Low-Dropout Regulators

General Description

The MIC29150/29300/29500/29750 are high current, high accuracy, low-dropout voltage regulators. Using Micrel's proprietary Super β PNP[®] process with a PNP pass element, these regulators feature 350mV to 425mV (full load) typical dropout voltages and very low ground current. Designed for high current loads, these devices also find applications in lower current, extremely low dropout-critical systems, where their tiny dropout voltage and ground current values are important attributes.

The MIC29150/29300/29500/29750 are fully protected against overcurrent faults, reversed input polarity, reversed lead insertion, overtemperature operation, and positive and negative transient voltage spikes. Five pin fixed voltage versions feature logic level ON/OFF control and an error flag which signals whenever the output falls out of regulation. Flagged states include low input voltage (dropout), output current limit, overtemperature shutdown, and extremely high voltage spikes on the input.

On the MIC29xx1 and MIC29xx2, the ENABLE pin may be tied to VIN if it is not required for ON/OFF control. The MIC29150/29300/29500 are available in 3-pin and 5-pin TO-220 and surface mount TO-263 (D²Pak) packages. The MIC29750 7.5A regulators are available in 3-pin and 5-pin TO-247 packages. The 1.5A, adjustable output MIC29152 is available in a 5-pin power D-Pak (TO-252) package.

For applications with input voltage 6V or below, see MIC37xxx LDOs.

Data sheets and support documentation can be found on Micrel's web site at www.micrel.com.

Features

- High current capability:
 - MIC29150/29151/29152/29153..... 1.5A
 - MIC29300/29301/29302/29303..... 3A
 - MIC29500/29501/29502/29503..... 5A
 - MIC29750/29751/29752..... 7.5A
- Low-dropout voltage
- Low ground current
- Accurate 1% guaranteed tolerance
- Extremely fast transient response
- Reverse-battery and "Load Dump" protection
- Zero-current shutdown mode (5-pin versions)
- Error flag signals output out-of-regulation (5-pin versions)
- Also characterized for smaller loads with industry-leading performance specifications
- Fixed voltage and adjustable versions

Applications

- Battery-powered equipment
- High-efficiency "Green" computer systems
- Automotive electronics
- High-efficiency linear lower supplies
- High-efficiency lost-regulator for switching supply

Typical Application**

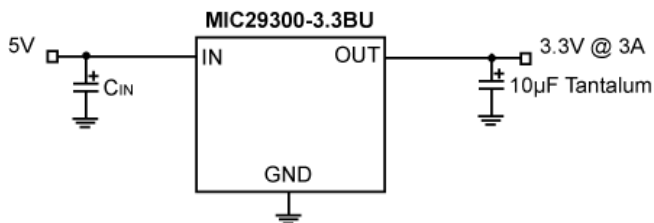

Fixed Output Voltage

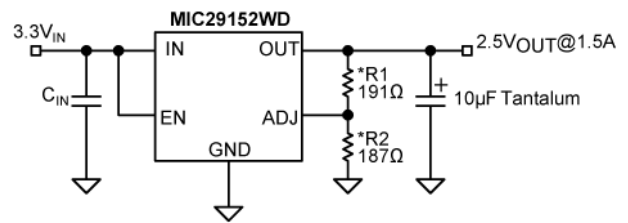

Adjustable Output Voltage

(*See Minimum Load Current Section)

Super β PNP is a registered trademark of Micrel, Inc.

**See Thermal Design Section

Ordering Information

Part Number		Junction Temperature Range ⁽¹⁾	Voltage	Current	Package
Standard	RoHS Compliant ⁽²⁾				
MIC29150-3.3BT	MIC29150-3.3WT ⁽²⁾	-40°C to +125°C	3.3	1.5A	3-Pin TO-220
MIC29150-3.3BU	MIC29150-3.3WU ⁽²⁾	-40°C to +125°C	3.3	1.5A	3-Pin TO-263
MIC29150-5.0BT	MIC29150-5.0WT ⁽²⁾	-40°C to +125°C	5	1.5A	3-Pin TO-220
MIC29150-5.0BU	MIC29150-5.0WU ⁽²⁾	-40°C to +125°C	5	1.5A	3-Pin TO-263
MIC29150-12BT	MIC29150-12WT ⁽²⁾	-40°C to +125°C	12	1.5A	3-Pin TO-220
MIC29150-12BU	MIC29150-12WU ⁽²⁾	-40°C to +125°C	12	1.5A	3-Pin TO-263
MIC29151-3.3BT	MIC29151-3.3WT ⁽²⁾	-40°C to +125°C	3.3	1.5A	5-Pin TO-220
MIC29151-3.3BU	MIC29151-3.3WU ⁽²⁾	-40°C to +125°C	3.3	1.5A	5-Pin TO-263
MIC29151-5.0BT	MIC29151-5.0WT ⁽²⁾	-40°C to +125°C	5	1.5A	5-Pin TO-220
MIC29151-5.0BU	MIC29151-5.0WU ⁽²⁾	-40°C to +125°C	5	1.5A	5-Pin TO-263
MIC29151-12BT	MIC29151-12WT ⁽²⁾	-40°C to +125°C	12	1.5A	5-Pin TO-220
MIC29151-12BU	MIC29151-12WU ⁽²⁾	-40°C to +125°C	12	1.5A	5-Pin TO-263
MIC29152BT	MIC29152WT ⁽²⁾	-40°C to +125°C	Adjustable	1.5A	5-Pin TO-220
MIC29152BU	MIC29152WU ⁽²⁾	-40°C to +125°C	Adjustable	1.5A	5-Pin TO-263
—	MIC29152WD ⁽²⁾	-40°C to +125°C	Adjustable	1.5A	5-Pin TO-252
MIC29153BT ⁽³⁾	Contact Factory	-40°C to +125°C	Adjustable	1.5A	5-Pin TO-220
MIC29153BU ⁽³⁾	Contact Factory	-40°C to +125°C	Adjustable	1.5A	5-Pin TO-263
MIC29300-3.3BT	MIC29300-3.3WT ⁽²⁾	-40°C to +125°C	3.3	3.0A	3-Pin TO-220
MIC29300-3.3BU	MIC29300-3.3WU ⁽²⁾	-40°C to +125°C	3.3	3.0A	3-Pin TO-263
MIC29300-5.0BT	MIC29300-5.0WT ⁽²⁾	-40°C to +125°C	5	3.0A	3-Pin TO-220
MIC29300-5.0BU	MIC29300-5.0WU ⁽²⁾	-40°C to +125°C	5	3.0A	3-Pin TO-263
MIC29300-12BT	MIC29300-12WT ⁽²⁾	-40°C to +125°C	12	3.0A	3-Pin TO-220
MIC29300-12BU	MIC29300-12WU ⁽²⁾	-40°C to +125°C	12	3.0A	3-Pin TO-263
MIC29301-3.3BT	MIC29301-3.3WT ⁽²⁾	-40°C to +125°C	3.3	3.0A	5-Pin TO-220
MIC29301-3.3BU	MIC29301-3.3WU ⁽²⁾	-40°C to +125°C	3.3	3.0A	5-Pin TO-263
MIC29301-5.0BT	MIC29301-5.0WT ⁽²⁾	-40°C to +125°C	5	3.0A	5-Pin TO-220
MIC29301-5.0BU	MIC29301-5.0WU ⁽²⁾	-40°C to +125°C	5	3.0A	5-Pin TO-263
MIC29301-12BT	MIC29301-12WT ⁽²⁾	-40°C to +125°C	12	3.0A	5-Pin TO-220
MIC29301-12BU	MIC29301-12WU ⁽²⁾	-40°C to +125°C	12	3.0A	5-Pin TO-263
MIC29302BT	MIC29302WT ⁽²⁾	-40°C to +125°C	Adjustable	3.0A	5-Pin TO-220
MIC29302BU	MIC29302WU ⁽²⁾	-40°C to +125°C	Adjustable	3.0A	5-Pin TO-263
MIC29303BT	MIC29303WT ⁽²⁾	-40°C to +125°C	Adjustable	3.0A	5-Pin TO-220
MIC29303BU	MIC29303WU ⁽²⁾	-40°C to +125°C	Adjustable	3.0A	5-Pin TO-263
MIC29500-3.3BT	MIC29500-3.3WT ⁽²⁾	-40°C to +125°C	3.3	5.0A	3-Pin TO-220

Notes:

1. Junction temperature.
2. RoHS compliant with 'high-melting solder' exemption.
3. Special Order; please contact factory for availability.

Ordering Information (Continued)

Part Number		Junction Temperature Range ⁽¹⁾	Voltage	Current	Package
Standard	RoHS Compliant ⁽²⁾				
MIC29500-5.0BT	MIC29500-5.0WT ⁽²⁾	-40°C to +125°C	5	5.0A	3-Pin TO-220
MIC29501-3.3BT	MIC29501-3.3WT ⁽²⁾	-40°C to +125°C	3.3	5.0A	5-Pin TO-220
MIC29501-3.3BU	MIC29501-3.3WU ⁽²⁾	-40°C to +125°C	3.3	5.0A	5-Pin TO-263
MIC29501-5.0BT	MIC29501-5.0WT ⁽²⁾	-40°C to +125°C	5	5.0A	5-Pin TO-220
MIC29501-5.0BU	MIC29501-5.0WU ⁽²⁾	-40°C to +125°C	5	5.0A	5-Pin TO-263
MIC29502BT	MIC29502WT ⁽²⁾	-40°C to +125°C	Adj.	5.0A	5-Pin TO-220
MIC29502BU	MIC29502WU ⁽²⁾	-40°C to +125°C	Adj.	5.0A	5-Pin TO-263
MIC29503BT	MIC29503WT ⁽²⁾	-40°C to +125°C	Adj.	5.0A	5-Pin TO-220
MIC29503BU	MIC29503WU ⁽²⁾	-40°C to +125°C	Adj.	5.0A	5-Pin TO-263
MIC29750-3.3BWT ⁽⁴⁾	Contact Factory ⁽⁴⁾	-40°C to +125°C	3.3	7.5A	3-Pin TO-247
MIC29750-5.0BWT ⁽⁴⁾	Contact Factory ⁽⁴⁾	-40°C to +125°C	5	7.5A	3-Pin TO-247
MIC29751-3.3BWT ⁽⁴⁾	Contact Factory ⁽⁴⁾	-40°C to +125°C	3.3	7.5A	5-Pin TO-247
MIC29751-5.0BWT ⁽⁴⁾	Contact Factory ⁽⁴⁾	-40°C to +125°C	5	7.5A	5-Pin TO-247
MIC29752BWT ⁽⁴⁾	MIC29752WWT ^(2, 4)	-40°C to +125°C	Adjustable	7.5A	5-Pin TO-247

Note:

4. Not recommended for design.

Pin Configuration

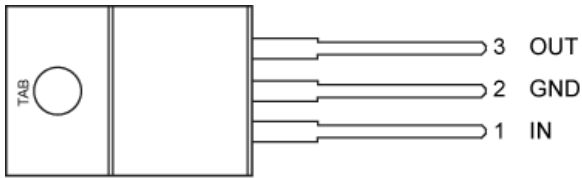

3-Pin TO-220 (T)
MIC29150/29300/29500

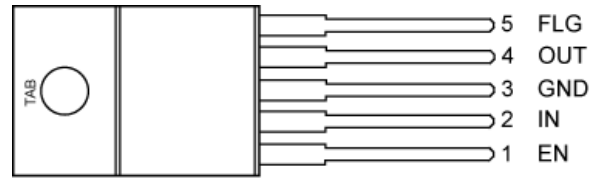

5-Pin TO-220 Fixed Voltage (T)
MIC29151/29301/29501/29751

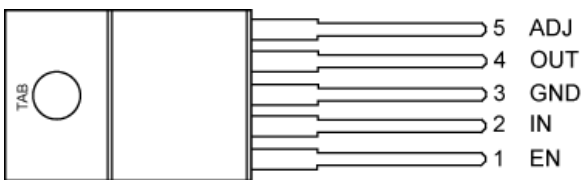

5-Pin TO-220 Adjustable Voltage (T)
MIC29152/29302/29502

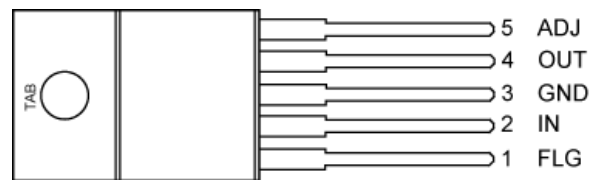

5-Pin TO-220 Adjustable with Flag (T)
MIC29153/29303/29503

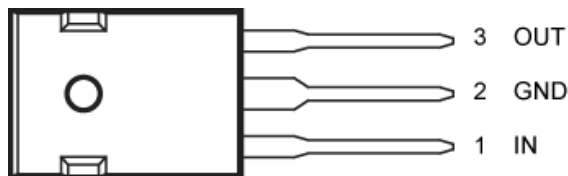

3-Pin TO-247 (WT)
MIC29750

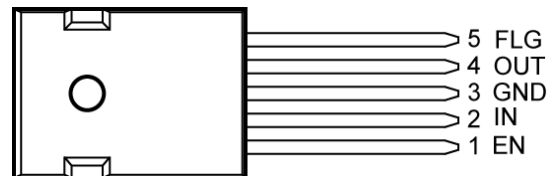

5-Pin TO-247 Fixed Voltage (WT)
MIC29751

Pin Configuration (Continued)

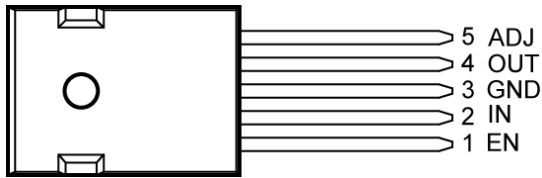

5-Pin TO-247 Adjustable Voltage (WT)
MIC29752

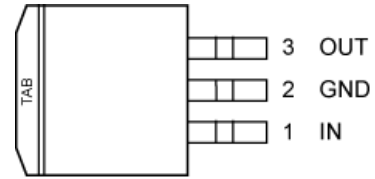

3-Pin TO-263 (D²Pak) (UT)
MIC29150/29300

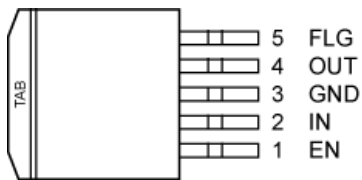

5-Pin TO-263 (D²Pak) Fixed Voltage (U)
MIC29151/29301/29501

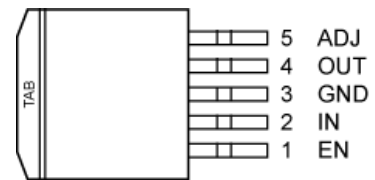

5-Pin TO-263 (D²Pak) Adjustable Voltage (U)
MIC29302/29502

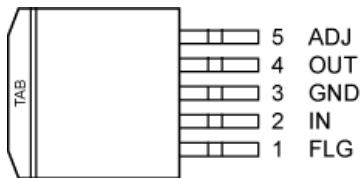

5-Pin TO-263 (D²Pak) Adjustable with Flag (U)
MIC29153/29303/29503

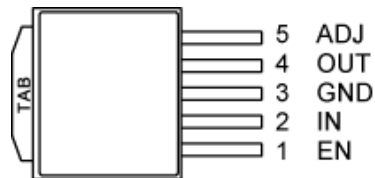

5-Pin TO-252 (D-Pak) Adjustable Voltage (D)
MIC29152

Pin Description

Pin Number TO-220 TO-247 TO-263	Pin Name
1	INPUT: Supplies the current to the output power device.
2	GND: TAB is also connected internally to the IC's ground on D-PAK.
3	OUTPUT: The regulator output voltage.

Pin Description

Pin Number Fixed TO-220 TO-247 TO-263	Pin Number Adjustable TO-220 TO-247 TO-252 TO-263	Pin Number Adj. with Flag TO-220 TO-247 TO-263	Pin Name
1	1	—	ENABLE: CMOS compatible control input. Logic high = enable, logic low = shutdown.
2	2	2	INPUT: Supplies the current to the output power device
3, TAB	3, TAB	3, TAB	GND: TAB is also connected internally to the IC's ground on D-PAK.
4	4	4	OUTPUT: The regulator output voltage
—	5	5	ADJUST: Adjustable regulator feedback input that connects to the resistor voltage divider that is placed from OUTPUT to GND in order to set the output voltage.
5	—	1	FLAG: Active low error flag output signal that indicates an output fault condition

Absolute Maximum Ratings⁽¹⁾

Input Supply Voltage (V_{IN}) ⁽¹⁾	-20V to +60V
Enable Input Voltage (V_{EN})	-0.3V to V_{IN}
Lead Temperature (soldering, 5sec.)	260°C
Power Dissipation	Internally Limited
Storage Temperature Range	-65°C to +150°C
ESD Rating	Note 3

Operating Ratings⁽²⁾

Operating Junction Temperature	-40°C to +125°C
Maximum Operating Input Voltage	26V
Package Thermal Resistance	
TO-220 (θ_{JC})	2°C/W
TO-263 (θ_{JC})	2°C/W
TO-247 (θ_{JC})	1.5°C/W
TO-252 (θ_{JC})	3°C/W
TO-252 (θ_{JA})	56°C/W

Electrical Characteristics^(4, 13)

$V_{IN} = V_{OUT} + 1V$; $I_{OUT} = 10mA$; $T_J = 25^\circ C$. **Bold** values indicate $-40^\circ C \leq T_J \leq +125^\circ C$, unless noted.

Parameter	Condition	Min.	Typ.	Max.	Units
Output Voltage	$I_{OUT} = 10mA$	-1		1	%
	$10mA \leq I_{OUT} \leq I_{FL}$, $(V_{OUT} + 1V) \leq V_{IN} \leq 26V$ ⁽⁵⁾	-2		2	
Line Regulation	$I_{OUT} = 10mA$, $(V_{OUT} + 1V) \leq V_{IN} \leq 26V$		0.06	0.5	%
Load Regulation	$V_{IN} = V_{OUT} + 1V$, $10mA \leq I_{OUT} \leq 1.5A$ ^(5,9)		0.2	1	%
$\frac{\Delta V_o}{\Delta T}$	Output Voltage ⁽⁹⁾ Temperature Coefficient.		20	100	ppm/°C
Dropout Voltage	$\Delta V_{OUT} = -1\%$ ⁽⁶⁾				mV
	MIC29150	$I_{OUT} = 100mA$	80	200	
		$I_{OUT} = 750mA$	220		
		$I_{OUT} = 1.5A$	350	600	
	MIC29300	$I_{OUT} = 100mA$	80	175	
		$I_{OUT} = 1.5A$	250		
		$I_{OUT} = 3A$	370	600	
	MIC29500	$I_{OUT} = 250mA$	125	250	
		$I_{OUT} = 2.5A$	250		
		$I_{OUT} = 5A$	370	600	
	MIC29750	$I_{OUT} = 250mA$	80	200	
		$I_{OUT} = 4A$	270		
	$I_{OUT} = 7.5A$	425	750		

Notes:

- Maximum positive supply voltage of 60V must be of limited duration (<100msec) and duty cycle ($\leq 1\%$). The maximum continuous supply voltage is 26V. Exceeding the absolute maximum rating may damage the device.
- The device is not guaranteed to function outside its operating rating.
- Devices are ESD sensitive. Handling precautions recommended.
- Specification for packaged product only.
- Full load current (I_{FL}) is defined as 1.5A for the MIC29150, 3A for the MIC29300, 5A for the MIC29500, and 7.5A for the MIC29750 families.
- Dropout voltage is defined as the input-to-output differential when the output voltage drops to 99% of its normal value with $V_{OUT} + 1V$ applied to V_{IN} .
- $V_{IN} = V_{OUT(nominal)} + 1V$. For example, use $V_{IN} = 4.3V$ for a 3.3V regulator or use 6V for a 5V regulator. Employ pulse-testing procedures to pin current.
- Ground pin current is the regulator quiescent current. The total current drawn from the source is the sum of the load current plus the ground pin current.
- Output voltage temperature coefficient is defined as the worst case voltage change divided by the total temperature range.
- Thermal regulation is defined as the change in output voltage at a time T after a change in power dissipation is applied, excluding load or line regulation effects. Specifications are for a 200mA load pulse at $V_{IN} = 20V$ (a 4W pulse) for $T = 10ms$.
- Comparator thresholds are expressed in terms of a voltage differential at the Adjust terminal below the nominal reference voltage measured at 6V input. To express these thresholds in terms of output voltage change, multiply by the error amplifier gain $= V_{OUT}/V_{REF} = (R1 + R2)/R2$. For example, at a programmed output voltage of 5V, the Error output is guaranteed to go low when the output drops by $95mV \times 5V/1.240V = 384mV$. Thresholds remain constant as a percent of V_{OUT} as V_{OUT} is varied, with the dropout warning occurring at typically 5% below nominal, 7.7% guaranteed.
- $V_{EN} \leq 0.8V$ and $V_{IN} \leq 26V$, $V_{OUT} = 0$.
- When used in dual supply systems where the regulator load is returned to a negative supply, the output voltage must be diode clamped to ground.

Electrical Characteristics^(4, 13) (Continued)

$V_{IN} = V_{OUT} + 1V$; $I_{OUT} = 10mA$; $T_J = 25^\circ C$. **Bold** values indicate $-40^\circ C \leq T_J \leq +125^\circ C$, unless noted.

Parameter	Condition	Min.	Typ.	Max.	Units
Ground Current	MIC29150	$I_{OUT} = 750mA, V_{IN} = V_{OUT} + 1V$ $I_{OUT} = 1.5A$ $I_{OUT} = 1.5A, V_{IN} = V_{OUT} + 1V$ $I_{OUT} = 3A$ $I_{OUT} = 2.5A, V_{IN} = V_{OUT} + 1V$ $I_{OUT} = 5A$ $I_{OUT} = 4A, V_{IN} = V_{OUT} + 1V$ $I_{OUT} = 7.5A$	8	20	mA
	MIC29300		22		
	MIC29500		10		
	MIC29750		37		
	Note 8		15		
			70	50	
			35	75	
			120		
I_{GRNDDO} Ground Pin Current at Dropout	$V_{IN} = 0.5V$ less than specified $V_{OUT} \times I_{OUT} = 10mA$				
	MIC29150		0.9		mA
	MIC29300		1.7		
	MIC29500		2.1		
MIC29750		3.1			
Current Limit	MIC29150	$V_{OUT} = 0V^{(7)}$ $V_{OUT} = 0V^{(7)}$ $V_{OUT} = 0V^{(7)}$ $V_{OUT} = 0V^{(7)}$		2.1	A
	MIC29300		4.5	3.5	
	MIC29500		7.5	5.0	
	MIC29750		9.5	10.0	
				15	
e_n , Output Noise Voltage (10Hz to 100kHz) $I_L = 100mA$	$C_L = 10\mu F$			400	μV (rms)
	$C_L = 33\mu F$			260	
Ground Current in Shutdown	MIC29150/1/2/3 only $V_{EN} = 0.4V$		2	10	μA
				30	
Reference – MIC29xx2/MIC29xx3					
Reference Voltage		1.228 1.215	1.240	1.252 1.265	V
Reference Voltage		1.203		1.277	V
Adjust Pin Bias Current			40	80 120	nA
Reference Voltage Temperature Coefficient	Note 10		20		ppm $^\circ C$
Adjust Pin Bias Current Temperature Coefficient			0.1		nA/ $^\circ C$
Flag Output (Error Comparator) – MIC29xx1/29xx3					
Output Leakage Current	$V_{OH} = 26V$		0.01	1.00 2.00	μA
Output Low Voltage	Device set for 5V, $V_{IN} = 4.5V$ $I_{OL} = 250\mu A$		220	300 400	mV
Upper Threshold Voltage	Device set for 5V ⁽¹¹⁾	40 25	60		mV
Lower Threshold Voltage	Device set for 5V ⁽¹¹⁾		75	95 140	mV
Hysteresis	Device set for 5V ⁽¹¹⁾		15		mV

Electrical Characteristics^(4, 13) (Continued)

$V_{IN} = V_{OUT} + 1V$; $I_{OUT} = 10mA$; $T_J = 25^\circ C$. **Bold** values indicate $-40^\circ C \leq T_J \leq +125^\circ C$, unless noted.

Parameter	Condition	Min.	Typ.	Max.	Units
ENABLE Input – MIC29xx1/MIC29xx2					
Input Logic Voltage Low (OFF) High (ON)		2.4		0.8	V
Enable Pin Input Current	$V_{EN} = 26V$		100	600 750	μA
	$V_{EN} = 0.8V$	0.7		2 4	
Regulator Output Current in Shutdown	Note 12		10	500	μA

Typical Characteristics (MIC2915x)

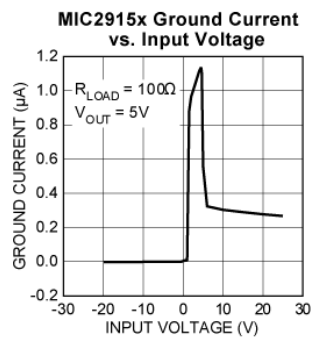
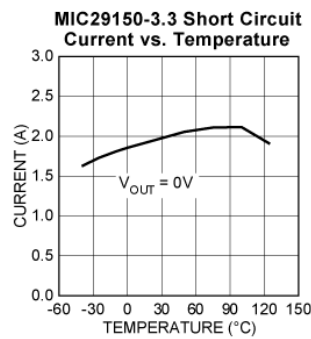
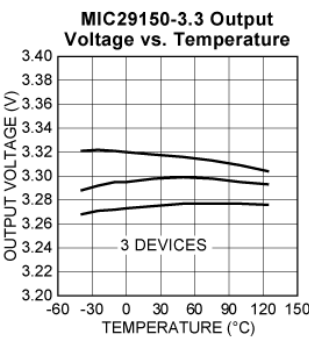
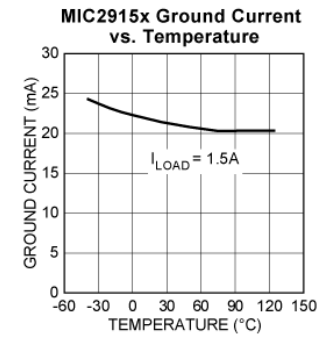
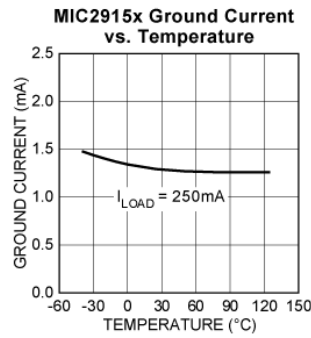
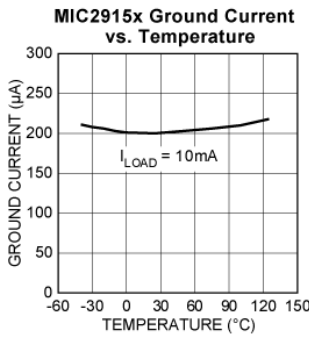
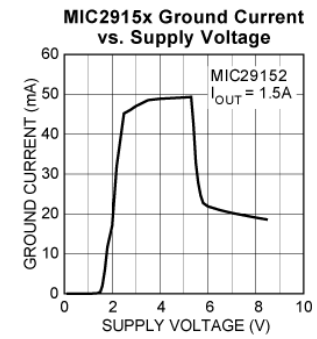
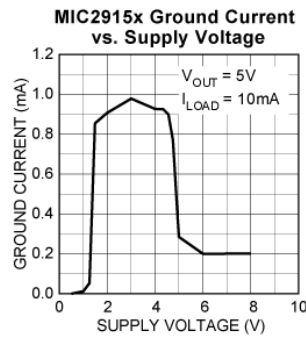
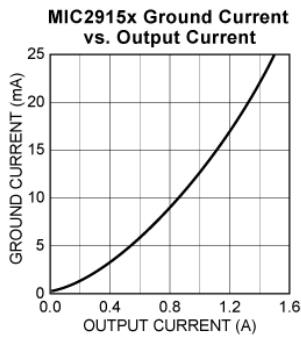
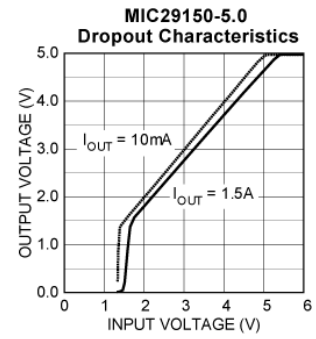
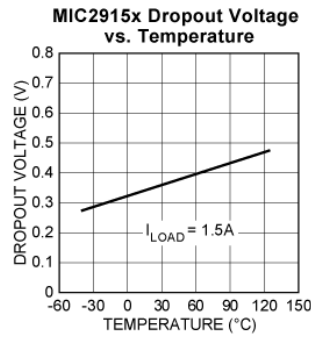
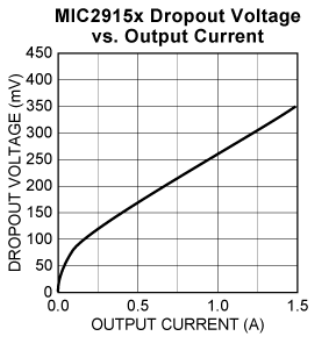

Typical Characteristics (MIC2915x) (Continued)

MIC29151-xx/2 Enable Current vs. Temperature

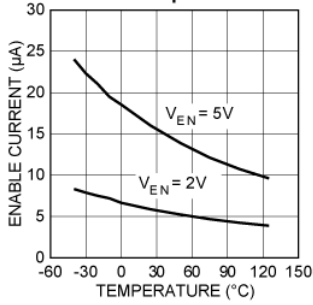

MIC2915x Load Transient

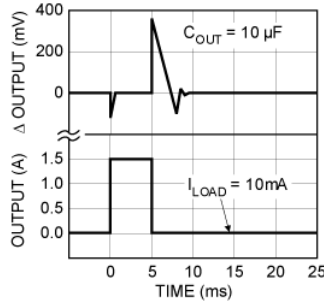

MIC2915x Load Transient

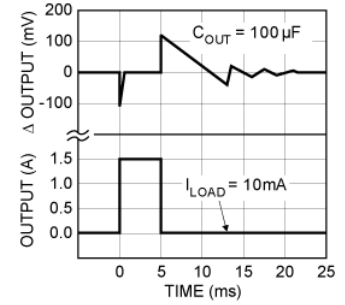

MIC29152/3 Adjust Pin Current vs. Temperature

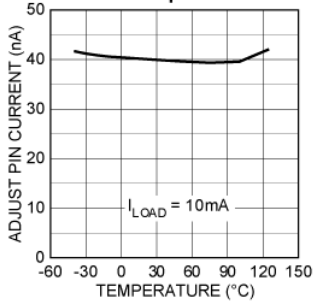

MIC2915x Line Transient

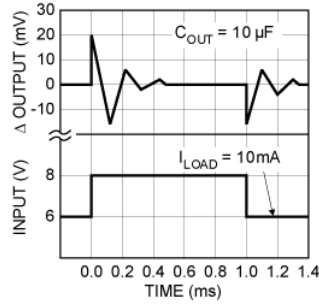

MIC2915x Line Transient

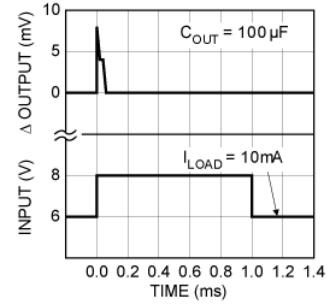

MIC2915x Output Impedance vs. Frequency

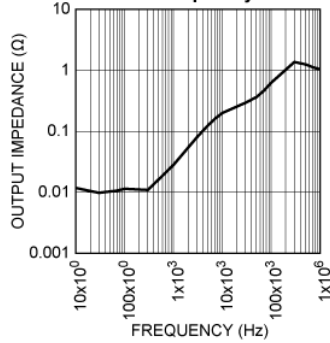

MIC29152 Ground Current vs. Temperature

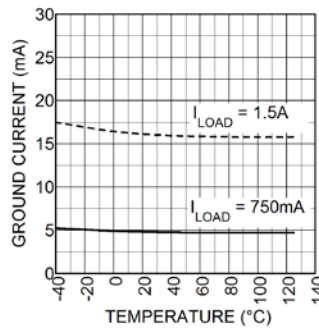

MIC29152 Dropout Voltage vs. Output Current

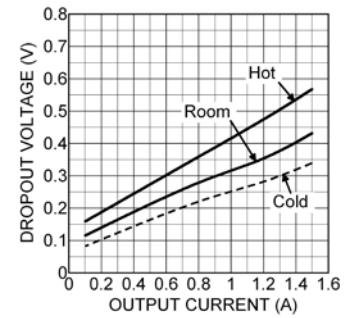

Typical Characteristics (MIC2930x)

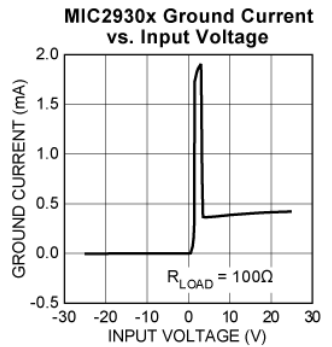
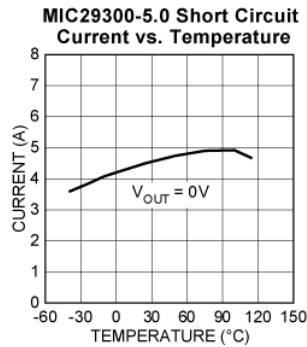
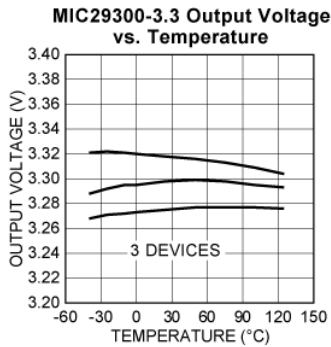
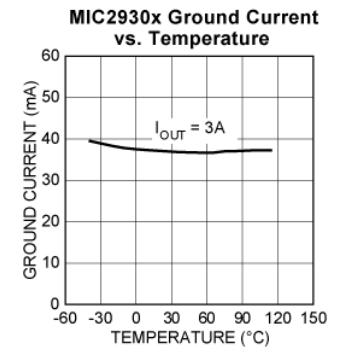
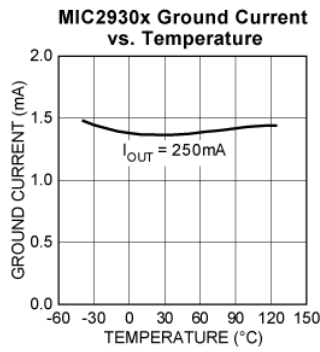
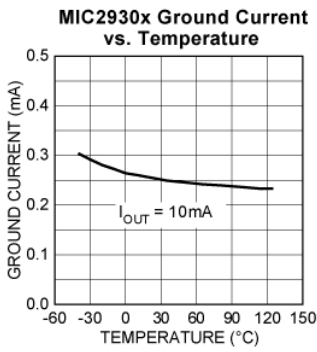
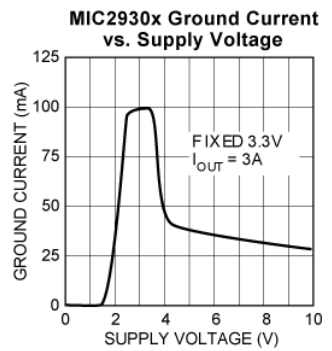
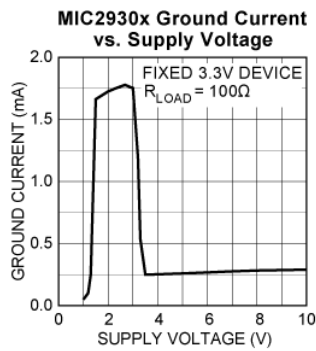
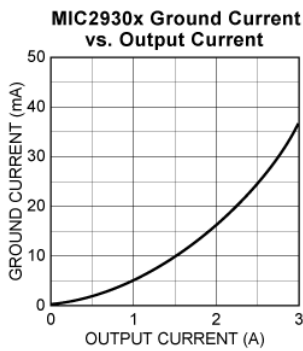
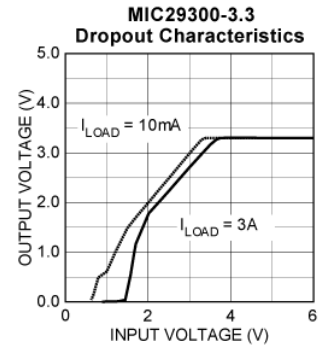
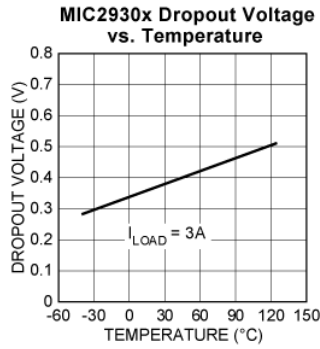
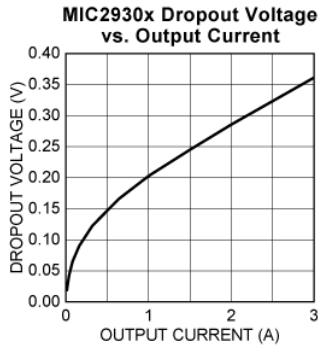

Typical Characteristics (MIC2930x) (Continued)

MIC29301-xx/2 Enable Current vs. Temperature

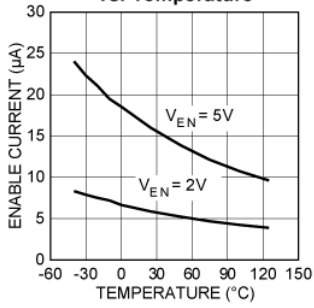

MIC2930x Load Transient

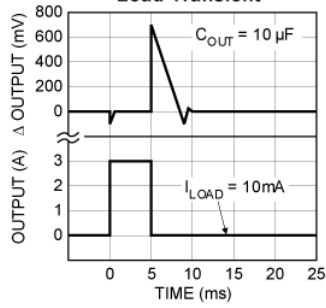

MIC2930x Load Transient

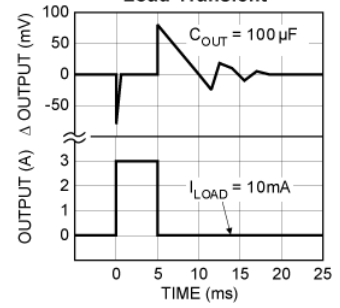

MIC29302/3 Adjust Pin Current vs. Temperature

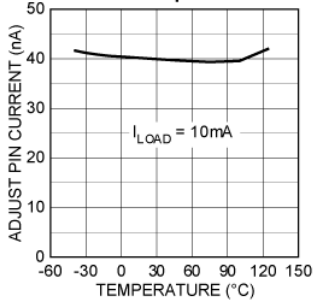

MIC2930x Line Transient

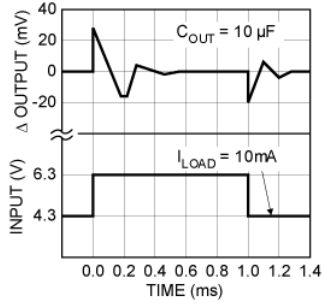

MIC2930x Line Transient

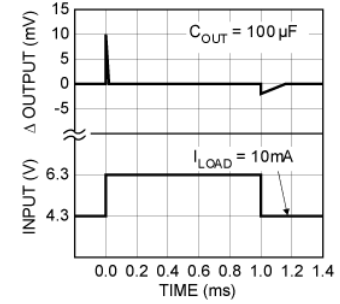

MIC2930x Output Impedance vs. Frequency

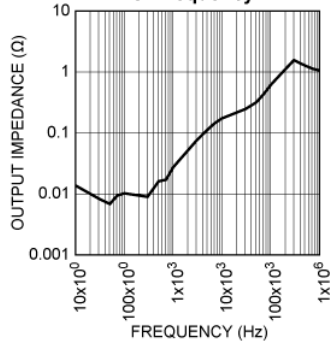

Typical Characteristics (MIC2950x)

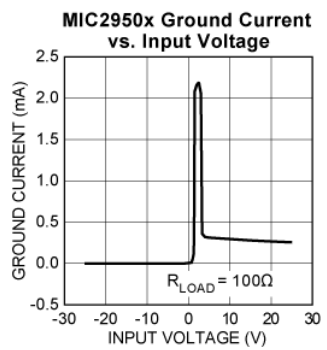
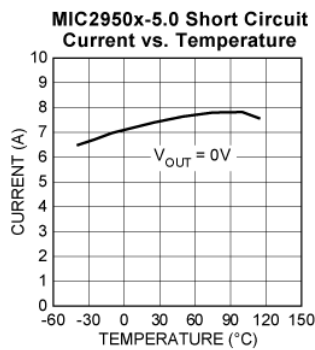
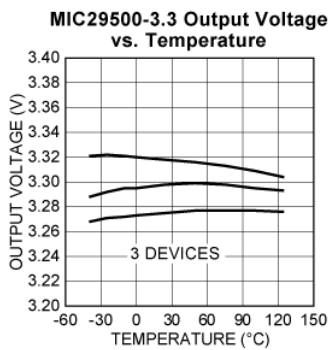
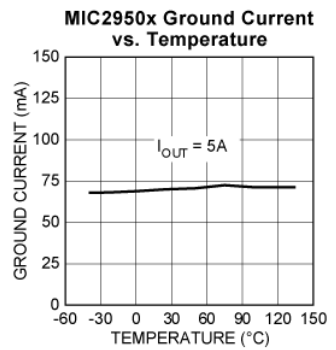
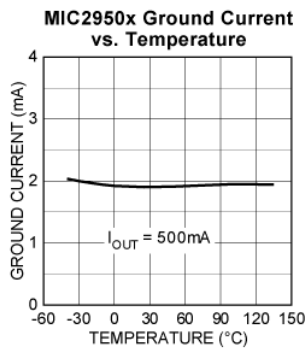
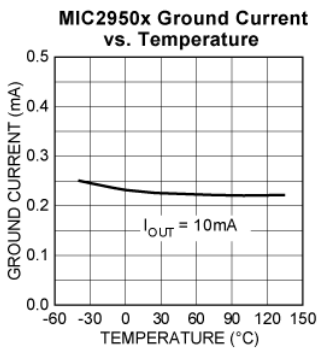
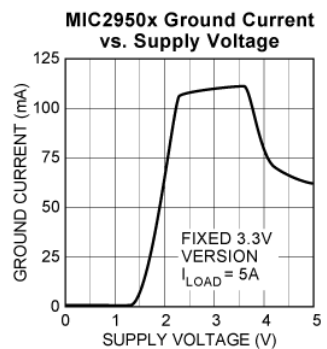
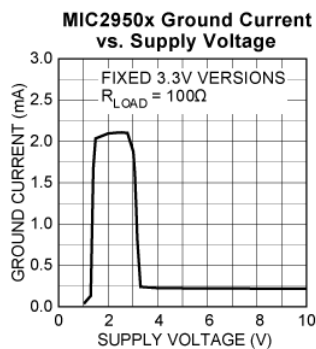
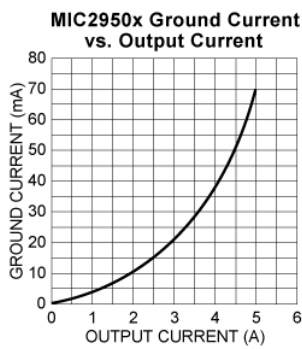
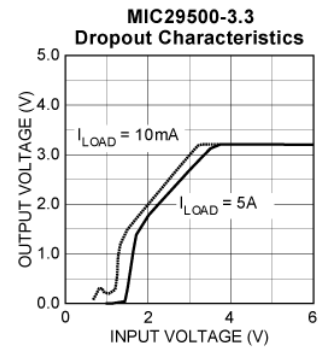
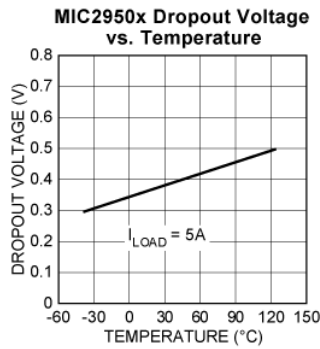
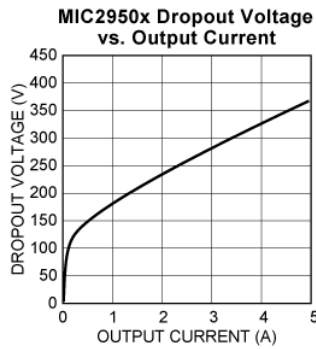

Typical Characteristics (MIC2950x) (Continued)

MIC29501-xx/2 Enable Current vs. Temperature

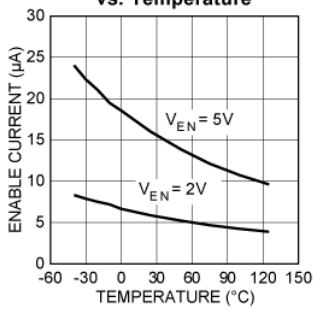

MIC2950x Load Transient

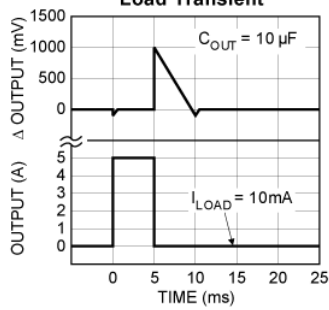

MIC2950x Load Transient

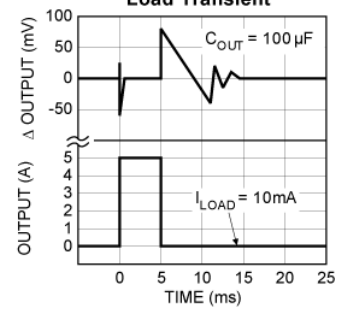

MIC29502/3 Adjust Pin Current vs. Temperature

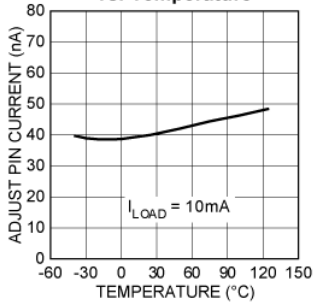

MIC2950x Line Transient

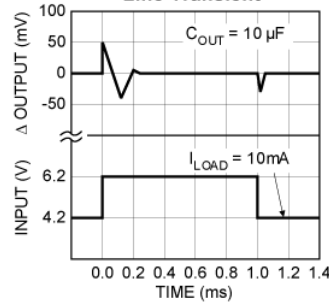

MIC2950x Line Transient

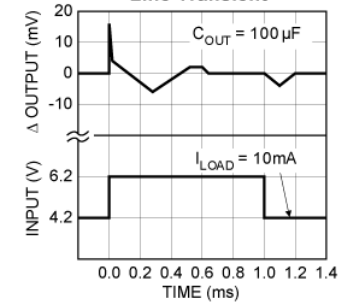

MIC2950x Output Impedance vs. Frequency

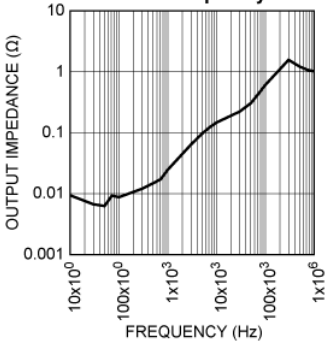

Typical Characteristics – MIC2975x

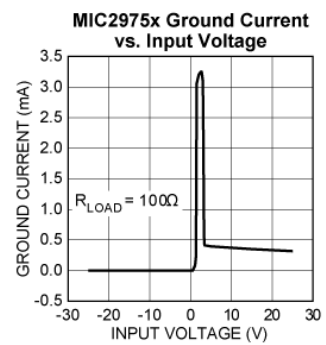
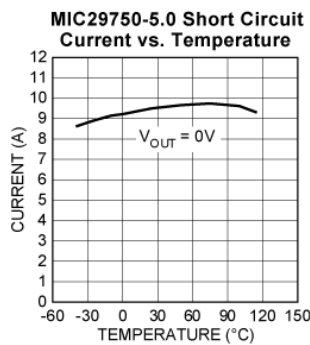
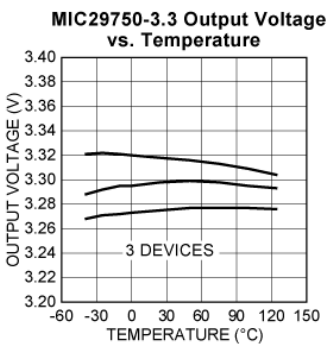
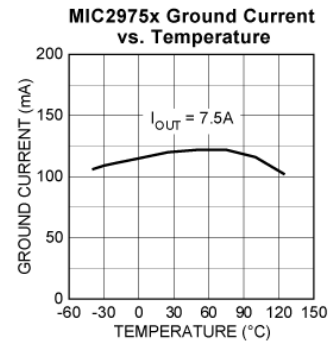
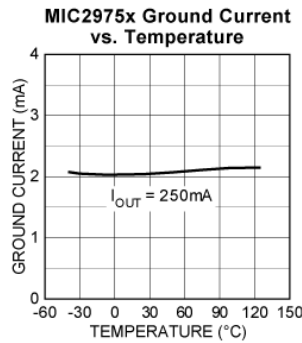
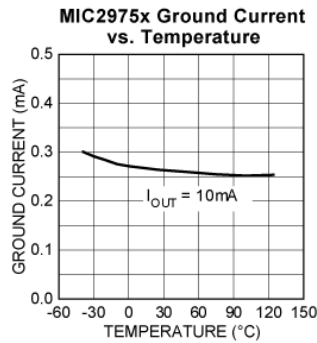
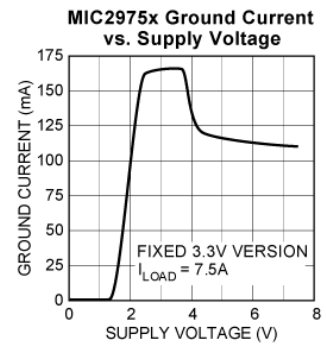
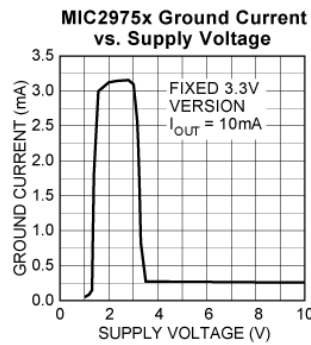
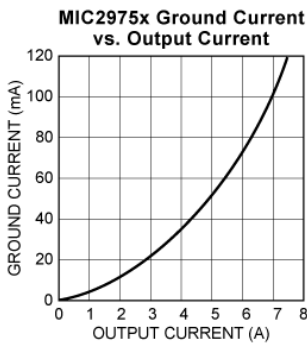
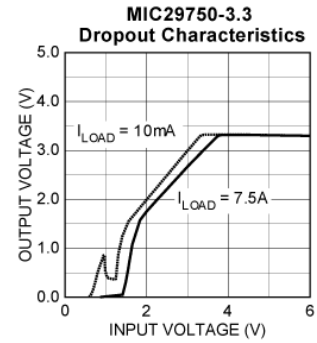
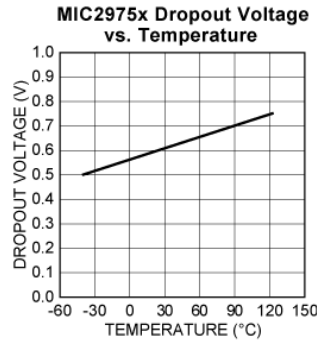
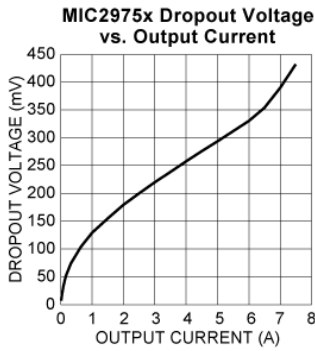

Typical Characteristics – MIC2975x (Continued)

MIC29751-xx/2 Enable Current vs. Temperature

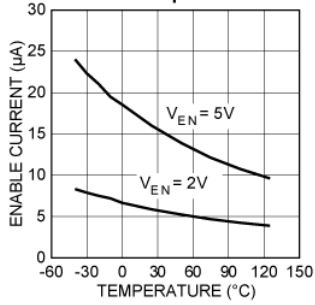

MIC2975x Load Transient

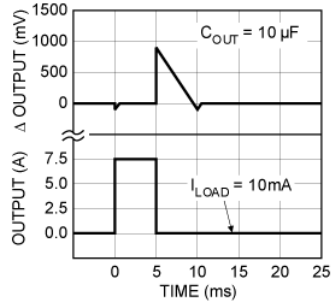

MIC2975x Load Transient

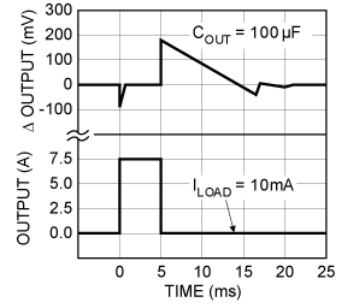

MIC29752/3 Adjust Pin Current vs. Temperature

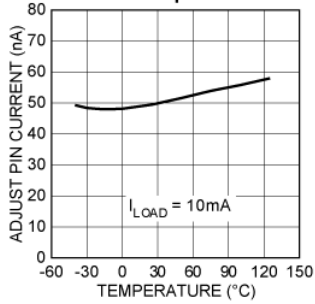

MIC2975x Line Transient

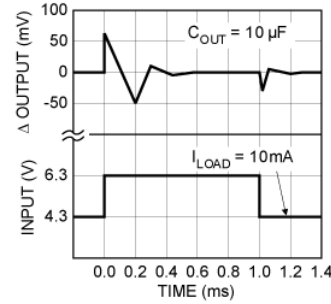

MIC2975x Line Transient

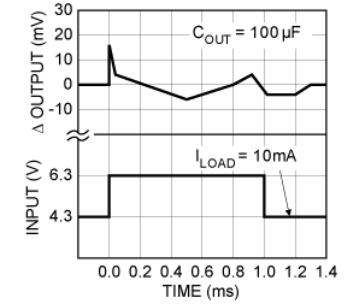

MIC2975x Output Impedance vs. Frequency

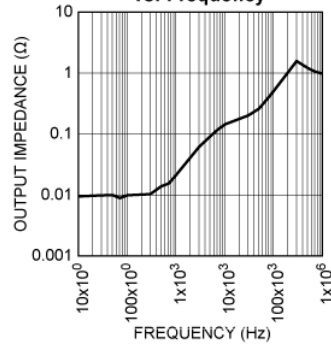

Functional Diagram

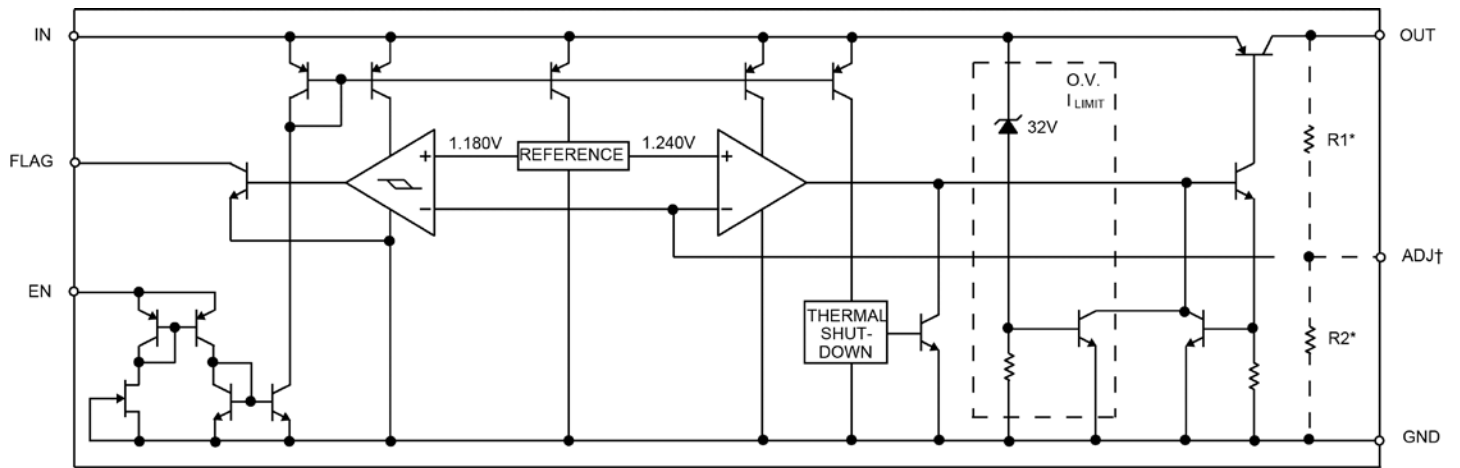

* FEEDBACK NETWORK IN FIXED VERSIONS ONLY
 † ADJUSTABLE VERSION ONLY

Application Information

The MIC29150/29300/29500/29750 are high-performance low-dropout voltage regulators suitable for all moderate to high-current voltage regulator applications. Their 350mV to 425mV typical dropout voltage at full load make them especially valuable in battery powered systems and as high efficiency noise filters in “post-regulator” applications. Unlike older NPN-pass transistor designs, where the minimum dropout voltage is limited by the base-emitter voltage drop and collector-emitter saturation voltage, dropout performance of the PNP output of these devices is limited merely by the low V_{CE} saturation voltage.

A trade-off for the low-dropout voltage is a varying base driver requirement. But Micrel's Super β PNP[®] process reduces this drive requirement to merely 1% of the load current.

The MIC29150/29300/29500/29750 family of regulators are fully protected from damage due to fault conditions. Current limiting is provided. This limiting is linear; output current under overload conditions is constant. Thermal shutdown disables the device when the die temperature exceeds the 125°C maximum safe operating temperature. Line transient protection allows device (and load) survival even when the input voltage spikes between -20V and +60V. When the input voltage exceeds approximately 32V, the over voltage sensor disables the regulator. The output structure of these regulators allows voltages in excess of the desired output voltage to be applied without reverse current flow. MIC29xx1 and MIC29xx2 versions offer a logic level ON/OFF control: when disabled, the devices draw nearly zero current.

An additional feature of this regulator family is a common pinout: a design's current requirement may change up or down yet use the same board layout, as all of these regulators have identical pinouts.

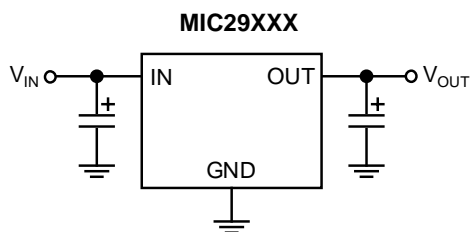

Figure 3. Linear Regulators Require Only Two Capacitors for Operation

Thermal Design

Linear regulators are simple to use. The most complicated design parameters to consider are thermal characteristics. Thermal design requires the following application-specific parameters:

- Maximum ambient temperature, T_A
- Output Current, I_{OUT}
- Output Voltage, V_{OUT}
- Input Voltage, V_{IN}

First, we calculate the power dissipation of the regulator from these numbers and the device parameters from this datasheet.

$$P_D = I_{OUT}(1.01 V_{IN} - V_{OUT}) \quad \text{Eq. 1}$$

where the ground current is approximated by 1% of I_{OUT} . Then the heat sink thermal resistance is determined with Equation 2:

$$\theta_{SA} = \frac{T_{JMAX} - T_A}{P_D} - (\theta_{JC} + \theta_{CS}) \quad \text{Eq. 2}$$

where $T_{JMAX} \leq 125^\circ\text{C}$ and θ_{CS} is between 0 and 2°C/W .

The heat sink may be significantly reduced in applications where the minimum input voltage is known and is large compared with the dropout voltage. Use a series input resistor to drop excessive voltage and distribute the heat between this resistor and the regulator. The low-dropout properties of Micrel Super β PNP[®] regulators allow very significant reductions in regulator power dissipation and the associated heat sink without compromising performance. When this technique is employed, a capacitor of at least $0.1\mu\text{F}$ is needed directly between the input and regulator ground.

Please refer to Application Note 9 and Application Hint 17 for further details and examples on thermal design and heat sink specification.

With no heat sink in the application, calculate the junction temperature to determine the maximum power dissipation that will be allowed before exceeding the maximum junction temperature of the MIC29152. The maximum power allowed can be calculated using the thermal resistance (θ_{JA}) of the D-Pak adhering to the following criteria for the PCB design: 2 oz. copper and 100mm^2 copper area for the MIC29152.

For example, given an expected maximum ambient temperature (T_A) of 75°C with $V_{IN} = 3.3V$, $V_{OUT} = 2.5V$, and $I_{OUT} = 1.5A$, first calculate the expected P_D using Equation 3:

$$P_D = (3.3V - 2.5V)1.5A - (3.3V)(0.016A) = 1.1472W \quad \text{Eq. 3}$$

Next, calculate the junction temperature for the expected power dissipation.

$$T_J = (\theta_{JA} \times P_D) + T_A = (56^\circ\text{C/W} \times 1.1472W) + 75^\circ\text{C} = 139.24^\circ\text{C} \quad \text{Eq. 4}$$

Now determine the maximum power dissipation allowed that would not exceed the IC's maximum junction temperature (125°C) without the use of a heat sink by:

$$P_{D(MAX)} = (T_{J(MAX)} - T_A) / \theta_{JA} = (125^\circ\text{C} - 75^\circ\text{C}) / (56^\circ\text{C/W}) = 0.893W \quad \text{Eq. 5}$$

Capacitor Requirements

For stability and minimum output noise, a capacitor on the regulator output is necessary. The value of this capacitor is dependent upon the output current; lower currents allow smaller capacitors. The MIC29150/29300/29500/29750 regulators are stable with the following minimum capacitor values at full load, as noted in Table 1:

Device	Full Load Capacitor
MIC29150	10µF
MIC29300	10µF
MIC29500	10µF
MIC29750	22µF

Table 1. Minimum Capacitor Values at Full Load

This capacitor need not be an expensive low ESR type: aluminum electrolytics are adequate. In fact, extremely low ESR capacitors may contribute to instability. Tantalum capacitors are recommended for systems where fast load transient response is important.

Where the regulator is powered from a source with high AC impedance, a 0.1µF capacitor connected between Input and GND is recommended. This capacitor should have good characteristics to above 250kHz.

Minimum Load Current

The MIC29150–29750 regulators are specified between finite loads. If the output current is too small, leakage currents dominate and the output voltage rises. The following minimum load current swamps any expected leakage current across the operating temperature range, as shown in Table 2:

Device	Minimum Load
MIC29150	5mA
MIC29300	7mA
MIC29500	10mA
MIC29750	10mA

Table 2. Minimum Load Currents

Adjustable Regulator Design

The adjustable regulator versions, MIC29xx2 and MIC29xx3, allow programming the output voltage anywhere between 1.25V and the 25V. Two resistors are used. The resistor values are calculated by Equation 6:

$$R_1 = R_2 \times \left(\frac{V_{OUT}}{1.240} - 1 \right) \quad \text{Eq. 6}$$

where V_{OUT} is the desired output voltage. Figure 4 shows component definition. Applications with widely varying load currents may scale the resistors to draw the minimum load current required for proper operation (see "Minimum Load Current" sub-section).

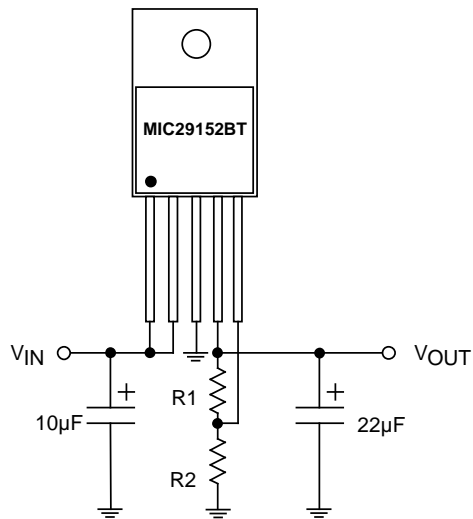

Figure 4. Adjustable Regulator with Resistors

Error Flag

MIC29xx1 and MIC29xx3 versions feature an Error Flag, which looks at the output voltage and signals an error condition when this voltage drops 5% below its expected value. The error flag is an open-collector output that pulls low under fault conditions. It may sink 10mA. Low output voltage signifies a number of possible problems, including an overcurrent fault (the device is in current limit) and low input voltage. The flag output is inoperative during overtemperature shutdown conditions.

Enable Input

MIC29xx1 and MIC29xx2 versions feature an enable (EN) input that allows ON/OFF control of the device. Special design allows “zero” current drain when the device is disabled—only microamperes of leakage current flows. The EN input has TTL/CMOS compatible thresholds for simple interfacing with logic, or may be directly tied to $\leq 30V$. Enabling the regulator requires approximately 20 μA of current.

Package Information⁽¹⁾

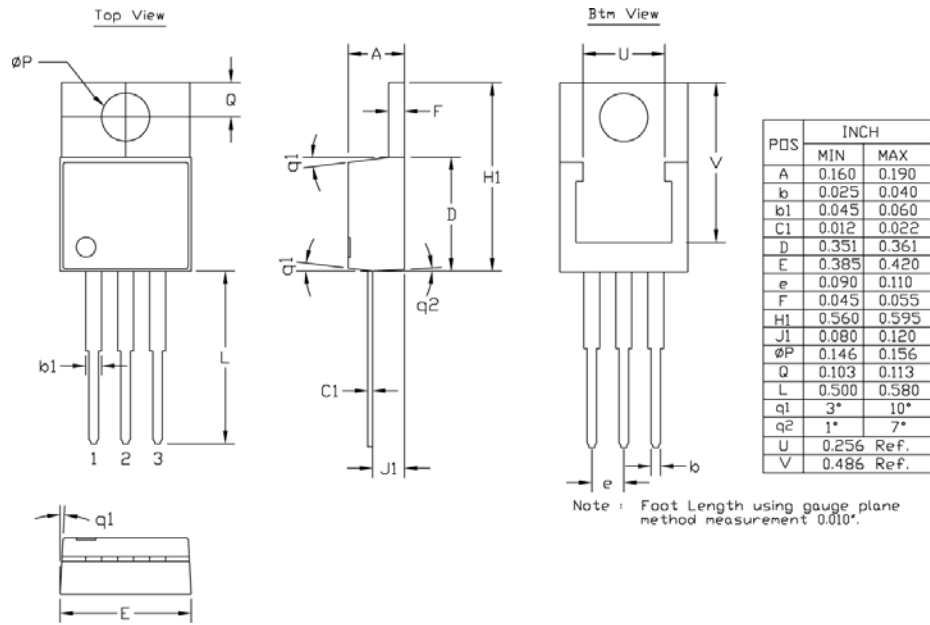

3-Pin TO-220 (T)

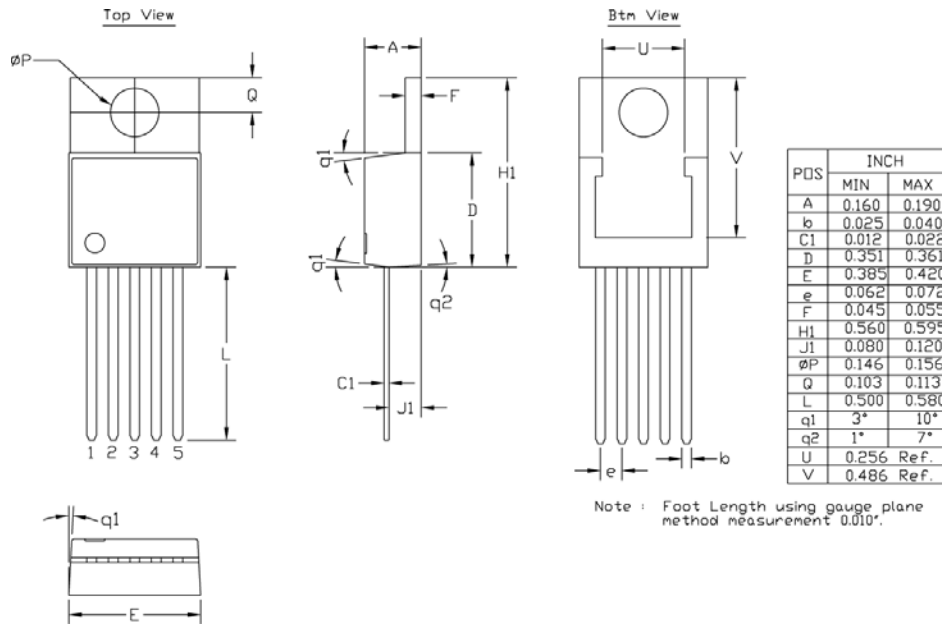

5-Pin TO-220 (T)

Note:

1. Package information is correct as of the publication date. For updates and most current information, go to www.micrel.com.

Package Information⁽¹⁾ (Continued)

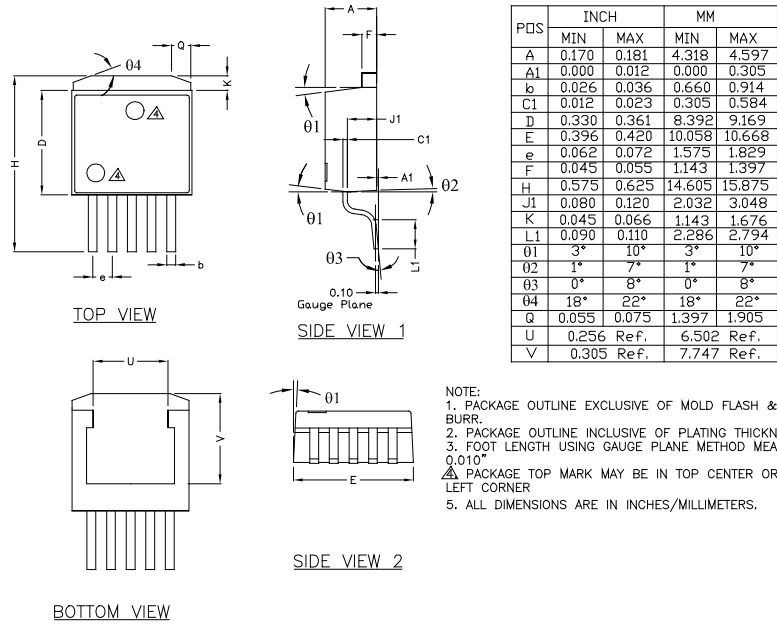

5-Pin TO-263 (U)

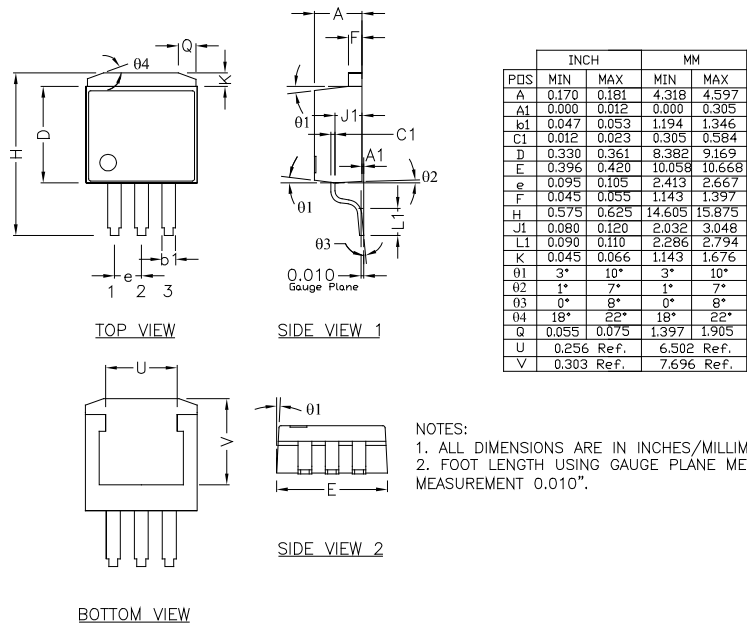

3-Pin TO-263 (U)

Package Information⁽¹⁾ (Continued)

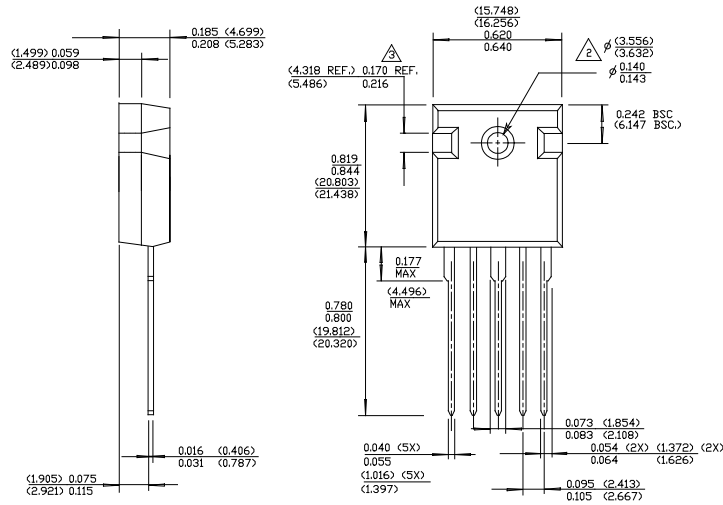

NOTE
 1. CONTROLLED DIMENSION IS INCH. DIMENSION IN BRACKET IS MILLIMETER.
 2. DIMENSIONS DO NOT INCLUDE END FLASH, MOLD FLASH, MATERIAL PROTRUSIONS.

5-Pin TO-247 (WT)

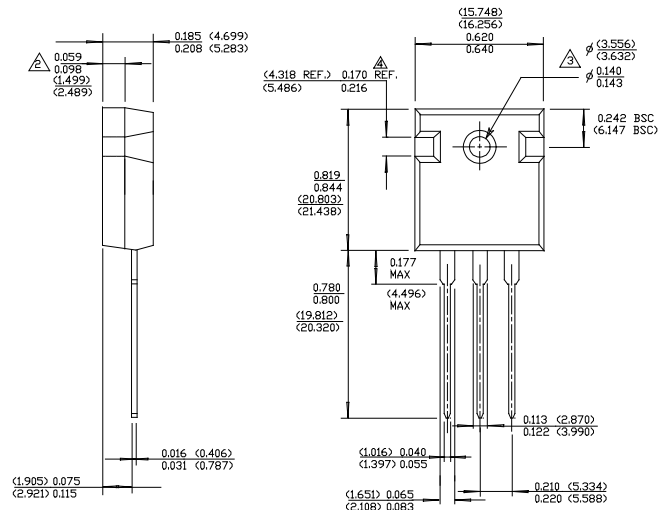

NOTE
 1. CONTROLLED DIMENSION IS INCH. DIMENSION IN BRACKET IS MILLIMETER.
 2. DIMENSIONS DO NOT INCLUDE END FLASH, MOLD FLASH, MATERIAL PROTRUSIONS.

3-Pin TO-247 (WT)

Package Information⁽¹⁾ (Continued)

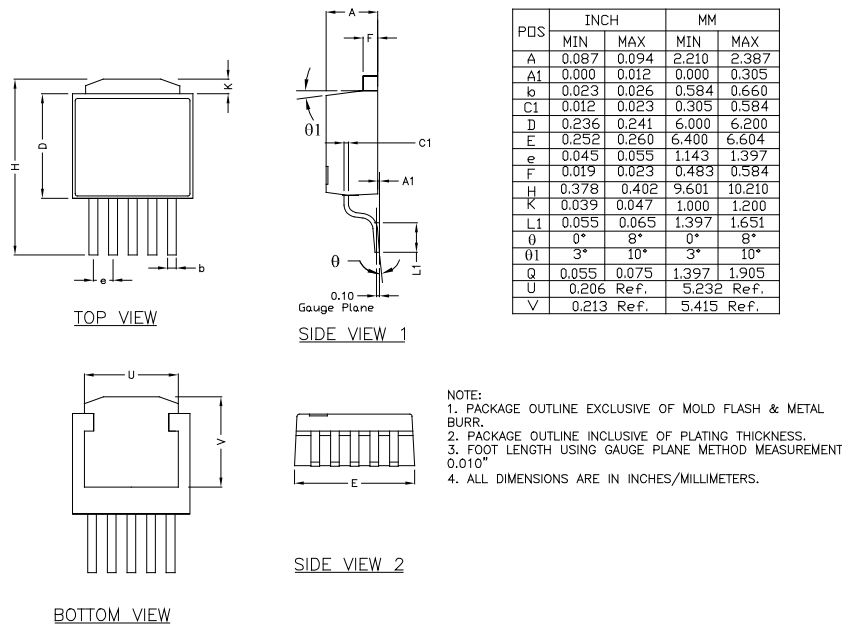

5-Pin TO-252 (D)

MICREL, INC. 2180 FORTUNE DRIVE SAN JOSE, CA 95131 USA
 TEL +1 (408) 944-0800 FAX +1 (408) 474-1000 WEB <http://www.micrel.com>

Micrel makes no representations or warranties with respect to the accuracy or completeness of the information furnished in this data sheet. This information is not intended as a warranty and Micrel does not assume responsibility for its use. Micrel reserves the right to change circuitry, specifications and descriptions at any time without notice. No license, whether express, implied, arising by estoppel or otherwise, to any intellectual property rights is granted by this document. Except as provided in Micrel's terms and conditions of sale for such products, Micrel assumes no liability whatsoever, and Micrel disclaims any express or implied warranty relating to the sale and/or use of Micrel products including liability or warranties relating to fitness for a particular purpose, merchantability, or infringement of any patent, copyright or other intellectual property right.

Micrel Products are not designed or authorized for use as components in life support appliances, devices or systems where malfunction of a product can reasonably be expected to result in personal injury. Life support devices or systems are devices or systems that (a) are intended for surgical implant into the body or (b) support or sustain life, and whose failure to perform can be reasonably expected to result in a significant injury to the user. A Purchaser's use or sale of Micrel Products for use in life support appliances, devices or systems is a Purchaser's own risk and Purchaser agrees to fully indemnify Micrel for any damages resulting from such use or sale.

X-ON Electronics

Largest Supplier of Electrical and Electronic Components

Click to view similar products for [LDO Voltage Regulators](#) category:

Click to view products by [Microchip](#) manufacturer:

Other Similar products are found below :

[AP7363-SP-13](#) [L79M05TL-E](#) [PT7M8202B12TA5EX](#) [TCR3DF185,LM\(CT](#) [TCR3DF24,LM\(CT](#) [TCR3DF285,LM\(CT](#) [TCR3DF31,LM\(CT](#)
[TCR3DF45,LM\(CT](#) [MP2013GQ-33-Z](#) [059985X](#) [NCP4687DH15T1G](#) [701326R](#) [TCR2EN28,LF\(S](#) [NCV8170AXV250T2G](#)
[TCR3DF27,LM\(CT](#) [TCR3DF19,LM\(CT](#) [TCR3DF125,LM\(CT](#) [TCR2EN18,LF\(S](#) [AP7315-25W5-7](#) [IFX30081LDVGRNXUMA1](#)
[NCV47411PAAJR2G](#) [AP2113KTR-G1](#) [AP2111H-1.2TRG1](#) [ZLDO1117QK50TC](#) [AZ1117IH-1.8TRG1](#) [TCR3DG12,LF](#) [MIC5514-3.3YMT-](#)
[T5](#) [MIC5512-1.2YMT-T5](#) [MIC5317-2.8YM5-T5](#) [SCD7912BTG](#) [NCP154MX180270TAG](#) [SCD33269T-5.0G](#) [NCV8170BMX330TCG](#)
[NCV8170AMX120TCG](#) [NCP706ABMX300TAG](#) [NCP153MX330180TCG](#) [NCP114BMX075TCG](#) [MC33269T-3.5G](#) [CAT6243-ADJCMT5T](#)
[TCR3DG33,LF](#) [AP2127N-1.0TRG1](#) [TCR4DG35,LF](#) [LT1117CST-3.3](#) [LT1117CST-5](#) [TAR5S15U\(TE85L,F\)](#) [TAR5S18U\(TE85L,F\)](#)
[TCR3UG19A,LF](#) [TCR4DG105,LF](#) [NCV8170AMX360TCG](#) [MIC94310-NYMT-T5](#)