

---

---

## 4 MHz 1.2A Internal Inductor PWM Buck Regulator with HyperLight Load<sup>®</sup> and Power Good

---

---

### Features

- Internal Inductor
- Simplifies Design to Two External Capacitors
- Input Voltage: 2.7V to 5.5V
- Output Voltage: Fixed or Adjustable (0.62V to 3.6V)
- Up to 1.2A Output Current
- Up to 93% Peak Efficiency
- 85% Typical Efficiency at 1 mA
- Power Good (PG) Output
- Programmable Soft-Start
- 22  $\mu$ A Typical Quiescent Current
- 4 MHz PWM Operation in Continuous Mode
- Ultra-Fast Transient Response
- Low Ripple Output Voltage
  - 35 mV<sub>PP</sub> Ripple in HyperLight Load<sup>®</sup> Mode
  - 7 mV Output Voltage Ripple in Full PWM Mode
- 0.01  $\mu$ A Shutdown Current
- Thermal Shutdown and Current Limit Protection
- 14-pin 3.0 x 3.5 x 1.1 mm TDFN Package
- -40°C to +125°C Junction Temperature Range

### Applications

- Solid State Drives (SSD)
- Mobile Handsets
- Portable Media/MP3 Players
- Portable Navigation Devices (GPS)
- WiFi/WiMax/WiBro Modules
- Wireless LAN Cards
- Portable Applications

### General Description

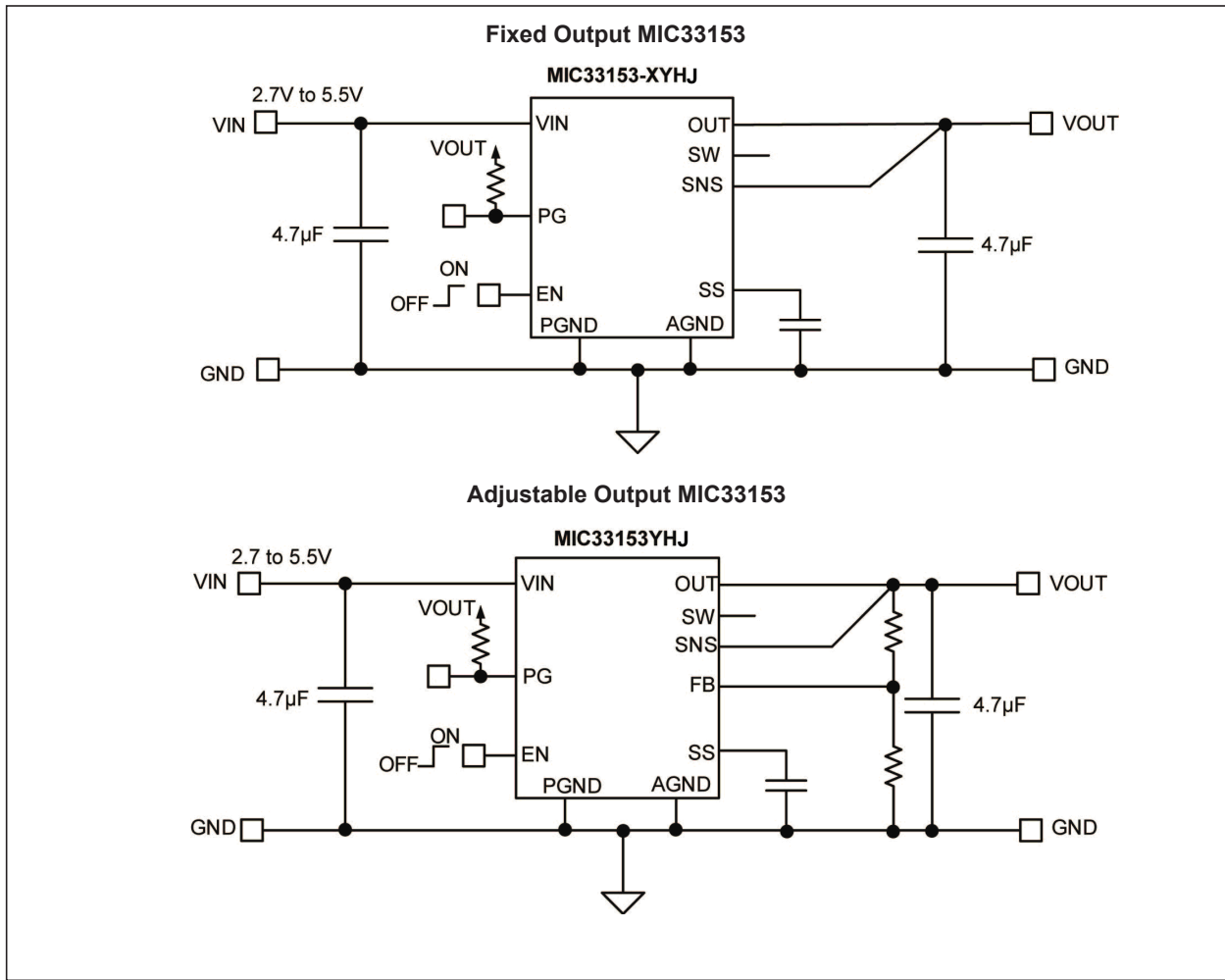
The MIC33153 is a high-efficiency 4 MHz 1.2A synchronous buck regulator with an internal inductor, HyperLight Load<sup>®</sup> mode, Power Good (PG) output indicator, and programmable soft-start. HyperLight Load<sup>®</sup> provides very high efficiency at light loads and ultra-fast transient response which makes the MIC33153 perfectly suited for supplying processor core voltages. An additional benefit of this proprietary architecture is very low output ripple voltage throughout the entire load range with the use of small output capacitors.

The MIC33153 is designed so that only two external capacitors as small as 2.2  $\mu$ F are needed for stability. This gives the MIC33153 the ease of use of an LDO with the efficiency of a HyperLight Load<sup>®</sup> DC converter. The MIC33153 achieves efficiency in HyperLight Load<sup>®</sup> mode as high as 85% at 1 mA, with a very low quiescent current of 22  $\mu$ A. At higher loads, the MIC33153 provides a constant switching frequency up to 4 MHz.

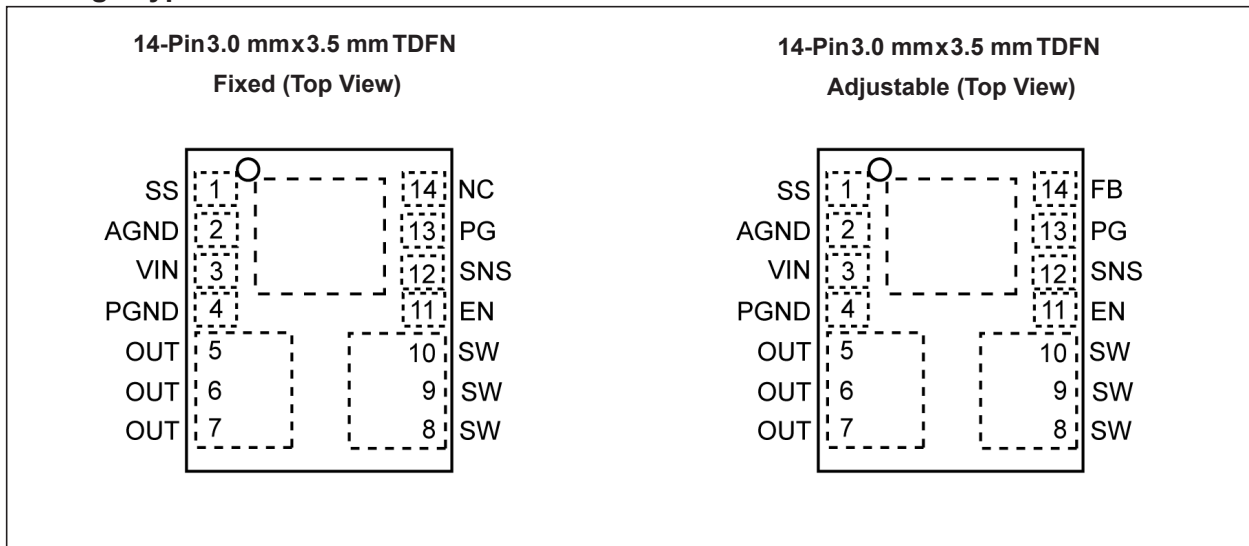
The MIC33153 is available in 14-pin 3.0 mm x 3.5 mm TDFN package with an operating junction temperature range from -40°C to +125°C.

# MIC33153

## Typical Application Circuits

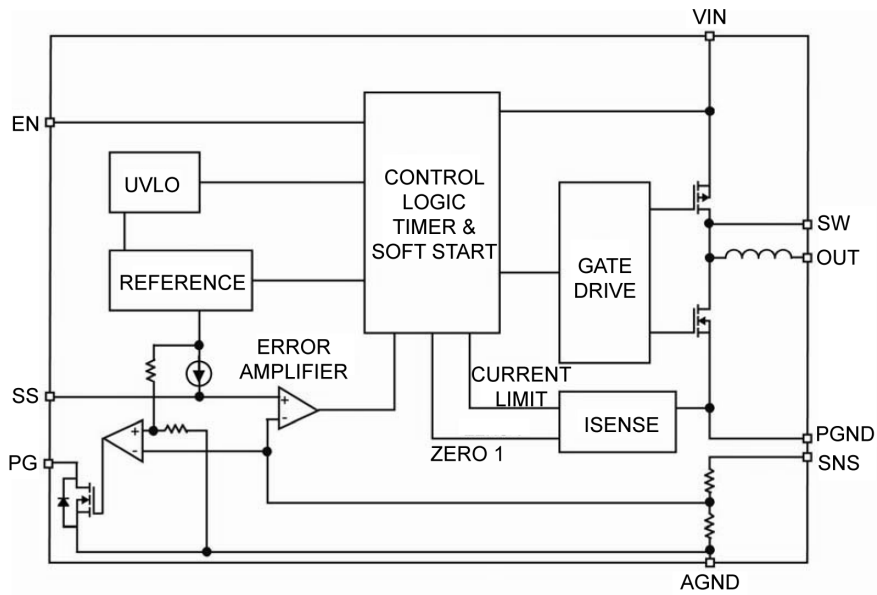


## Package Types

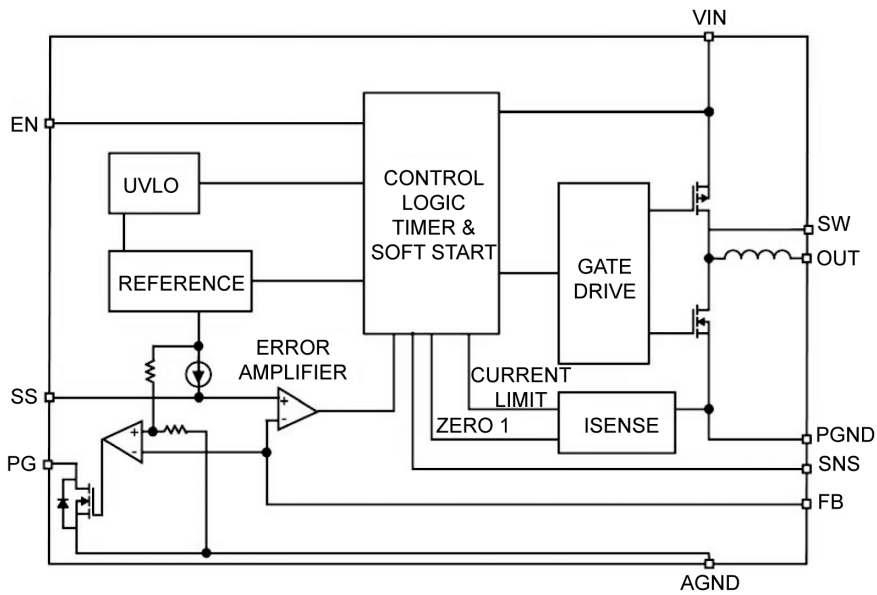


## Functional Block Diagrams

**Simplified MIC33153 Fixed Output Functional Block**



**Simplified MIC33153 Adjustable Output Functional Block**



# MIC33153

## 1.0 ELECTRICAL CHARACTERISTICS

### Absolute Maximum Ratings †

|  |                  |
|--|------------------|
| Supply Voltage ( $V_{IN}$ ).....           | -0.3 to +6V      |
| Sense Voltage ( $V_{SNS}$ ) .....          | -0.3 to $V_{IN}$ |
| Output Switch Voltage ( $V_{SW}$ ) .....   | -0.3 to $V_{IN}$ |
| Enable Input Voltage ( $V_{EN}$ ) .....    | -0.3 to $V_{IN}$ |
| Power Good (PG) Voltage ( $V_{PG}$ ).....  | -0.3 to $V_{IN}$ |
| ESD Rating (Note 1).....                   | ESD Sensitive    |
| Storage Temperature Range ( $T_S$ ) .....  | -65°C to +150°C  |
| Lead Temperature (soldering, 10 sec.)..... | 260°C            |

### Operating Ratings ‡

|   |                        |
|---|------------------------|
| Supply Voltage ( $V_{IN}$ ).....                | +2.7V to +5.5V         |
| Enable Input Voltage ( $V_{EN}$ ) .....         | 0V to $V_{IN}$         |
| Sense Voltage ( $V_{SNS}$ ) .....               | 0.62V to 3.6V          |
| Junction Temperature Range ( $T_J$ ) .....      | -40°C ≤ $T_J$ ≤ +125°C |
| Thermal Resistance                              |                        |
| 3.0 mm x 3.5 mm TDFN-14 ( $\theta_{JA}$ ) ..... | 55°C/W                 |

† **Notice:** Stresses above those listed under “Absolute Maximum Ratings” may cause permanent damage to the device. This is a stress rating only and functional operation of the device at those or any other conditions above those indicated in the operational sections of this specification is not intended. Exposure to maximum rating conditions for extended periods may affect device reliability. Specifications are for packaged product only.

‡ **Notice:** The device is not guaranteed to function outside its operating ratings.

**Note 1:** Devices are ESD sensitive. Handling precautions are recommended. Human body model, 1.5 kΩ in series with 100 pF.

## ELECTRICAL CHARACTERISTICS

**Electrical Characteristics:**  $T_A = 25^\circ\text{C}$ ,  $V_{IN} = V_{EN} = 3.6\text{V}$ ;  $C_{OUT} = 4.7 \mu\text{F}$ ; unless otherwise specified. **Bold** values indicate  $-40^\circ\text{C} \leq T_J \leq +125^\circ\text{C}$ .

| Parameter                       | Symbol | Min.        | Typ. | Max.        | Units | Conditions  |
|---------------------------------|--------|-------------|------|-------------|-------|---|
| Supply Voltage Range            | —      | <b>2.7</b>  | —    | <b>5.5</b>  | V     | —   |
| Undervoltage Lockout Threshold  | —      | <b>2.45</b> | 2.55 | <b>2.65</b> | V     | Turn-On   |
| Undervoltage Lockout Hysteresis | —      | —           | 75   | —           | mV    | —   |
| Quiescent Current               | —      | —           | 22   | <b>45</b>   | μA    | $I_{OUT} = 0 \text{ mA}$ , $SNS > 1.2 * V_{OUT(NOM)}$   |
| Shutdown Current                | —      | —           | 0.01 | <b>5</b>    | μA    | $V_{EN} = 0\text{V}$ ; $V_{IN} = 5.5\text{V}$   |
| Output Voltage Accuracy         | —      | -2.5        | —    | +2.5        | %     | $V_{IN} = 3.6\text{V}$ if $V_{OUT(NOM)} < 2.5\text{V}$ , $I_{LOAD} = 20 \text{ mA}$                     |
|                                 |        |             |      |             |       | $V_{IN} = 4.5\text{V}$ to $5.5\text{V}$ if $V_{OUT(NOM)} \geq 2.5\text{V}$ , $I_{LOAD} = 20 \text{ mA}$ |
| Feedback Regulation Voltage     | —      | 0.6045      | 0.62 | 0.6355      | V     | $I_{LOAD} = 20 \text{ mA}$  |
| Current Limit                   | —      | <b>2.2</b>  | 3.3  | —           | A     | $SNS = 0.9 * V_{OUT(NOM)}$  |
| Output Voltage Line Regulation  | —      | —           | 0.3  | —           | %V    | $V_{IN} = 3.6\text{V}$ to $5.5\text{V}$ if $V_{OUT(NOM)} < 2.5\text{V}$ , $I_{LOAD} = 20 \text{ mA}$    |
|                                 |        |             |      | —           |       | $V_{IN} = 4.5\text{V}$ to $5.5\text{V}$ if $V_{OUT(NOM)} \geq 2.5\text{V}$ , $I_{LOAD} = 20 \text{ mA}$ |

## ELECTRICAL CHARACTERISTICS (CONTINUED)

**Electrical Characteristics:**  $T_A = 25^\circ\text{C}$ ,  $V_{IN} = V_{EN} = 3.6\text{V}$ ;  $C_{OUT} = 4.7\ \mu\text{F}$ ; unless otherwise specified. **Bold** values indicate  $-40^\circ\text{C} \leq T_J \leq +125^\circ\text{C}$ .

| Parameter                           | Symbol | Min.       | Typ. | Max.       | Units            | Conditions  |
|-------------------------------------|--------|------------|------|------------|------------------|---|
| Output Voltage Load Regulation      | —      | —          | 0.8  | —          | % / A            | $1\ \text{mA} < I_{LOAD} < 1\ \text{A}$ , $V_{IN} = 3.6\text{V}$ if $V_{OUT(NOM)} < 2.5\text{V}$    |
|                                     |        | —          | 0.85 | —          |                  | $1\ \text{mA} < I_{LOAD} < 1\ \text{A}$ , $V_{IN} = 5.0\text{V}$ if $V_{OUT(NOM)} \geq 2.5\text{V}$ |
| PWM Switch On-Resistance            | —      | —          | 0.2  | —          | $\Omega$         | $I_{SW} = 100\ \text{mA}$ PMOS  |
|                                     | —      | —          | 0.19 | —          |                  | $I_{SW} = -100\ \text{mA}$ NMOS   |
| Maximum Switching Frequency         | —      | —          | 4    | —          | MHz              | $I_{OUT} = 300\ \text{mA}$  |
| Soft-Start Time                     | —      | —          | 320  | —          | $\mu\text{s}$    | $V_{OUT} = 90\%$ , $C_{SS} = 470\ \text{pF}$  |
| Soft-Start Current                  | —      | —          | 2.7  | —          | $\mu\text{A}$    | $V_{SS} = 0\text{V}$  |
| PG Threshold (Rising)               | —      | 86         | 92   | 96         | %                | —   |
| PG Threshold Hysteresis             | —      | —          | 7    | —          | %                | —   |
| PG Delay Time                       | —      | —          | 68   | —          | $\mu\text{s}$    | Rising  |
| Enable Threshold                    | —      | <b>0.5</b> | 0.9  | <b>1.2</b> | V                | Turn-On   |
| Enable Input Current                | —      | —          | 0.1  | <b>2</b>   | $\mu\text{A}$    | —   |
| Overtemperature Shutdown            | —      | —          | 160  | —          | $^\circ\text{C}$ | —   |
| Overtemperature Shutdown Hysteresis | —      | —          | 20   | —          | $^\circ\text{C}$ | —   |

# MIC33153

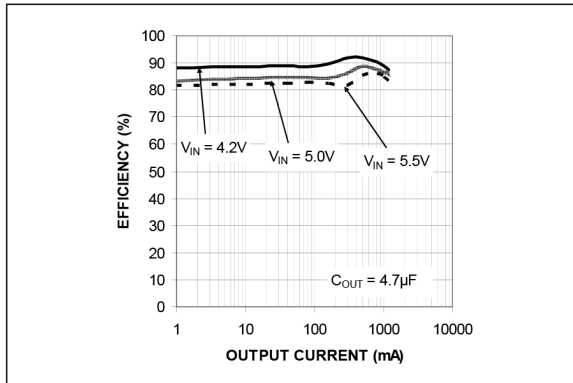
## TEMPERATURE SPECIFICATIONS (Note 1)

| Parameters                           | Symbol        | Min. | Typ. | Max. | Units | Conditions         |
|--------------------------------------|---------------|------|------|------|-------|--------------------|
| <b>Temperature Ranges</b>            |               |      |      |      |       |                    |
| Junction Operating Temperature Range | $T_J$         | -40  | —    | +125 | °C    | —                  |
| Storage Temperature Range            | $T_S$         | -65  | —    | +150 | °C    | —                  |
| Lead Temperature                     | —             | —    | —    | 260  | °C    | Soldering, 10 sec. |
| <b>Package Thermal Resistances</b>   |               |      |      |      |       |                    |
| Thermal Resistance 14-Lead TDFN      | $\theta_{JA}$ | —    | 55   | —    | °C/W  | —                  |

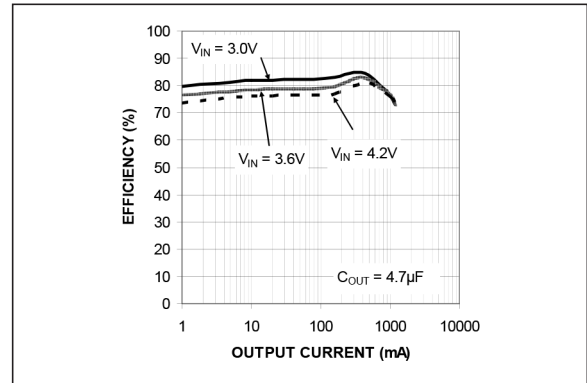
**Note 1:** The maximum allowable power dissipation is a function of ambient temperature, the maximum allowable junction temperature and the thermal resistance from junction to air (i.e.,  $T_A$ ,  $T_J$ ,  $\theta_{JA}$ ). Exceeding the maximum allowable power dissipation will cause the device operating junction temperature to exceed the maximum +125°C rating. Sustained junction temperatures above +125°C can impact the device reliability.

## 2.0 TYPICAL PERFORMANCE CURVES

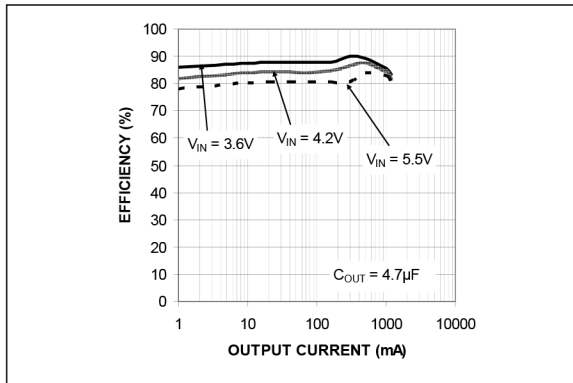
**Note:** The graphs and tables provided following this note are a statistical summary based on a limited number of samples and are provided for informational purposes only. The performance characteristics listed herein are not tested or guaranteed. In some graphs or tables, the data presented may be outside the specified operating range (e.g., outside specified power supply range) and therefore outside the warranted range.



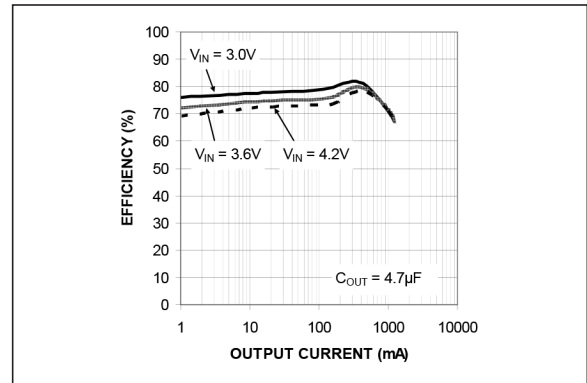
**FIGURE 2-1:** Efficiency ( $V_{OUT} = 3.3V$ ).



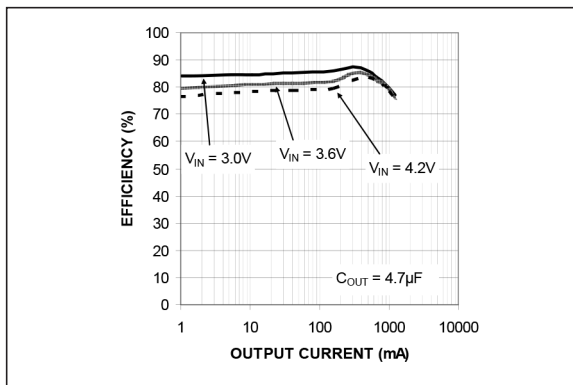
**FIGURE 2-4:** Efficiency ( $V_{OUT} = 1.5V$ ).



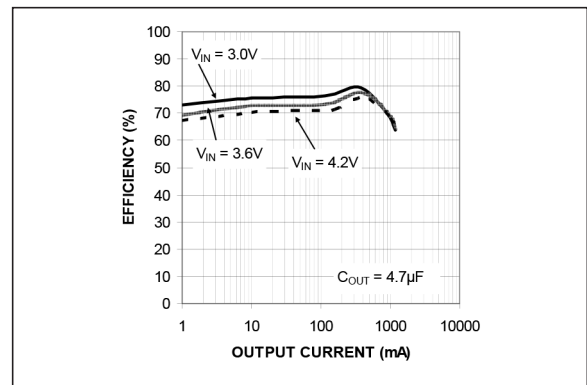
**FIGURE 2-2:** Efficiency ( $V_{OUT} = 2.5V$ ).



**FIGURE 2-5:** Efficiency ( $V_{OUT} = 1.2V$ ).

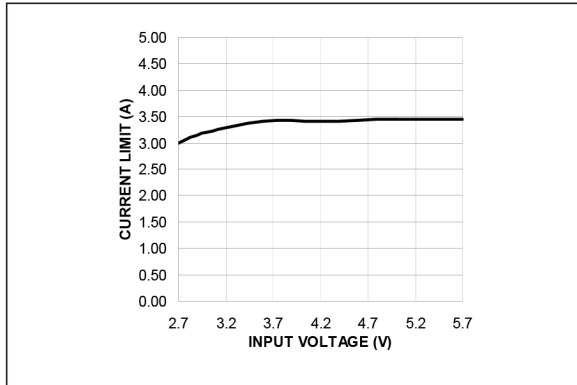


**FIGURE 2-3:** Efficiency ( $V_{OUT} = 1.8V$ ).

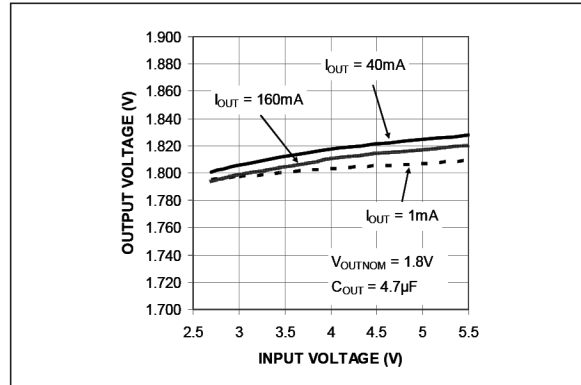


**FIGURE 2-6:** Efficiency ( $V_{OUT} = 1.0V$ ).

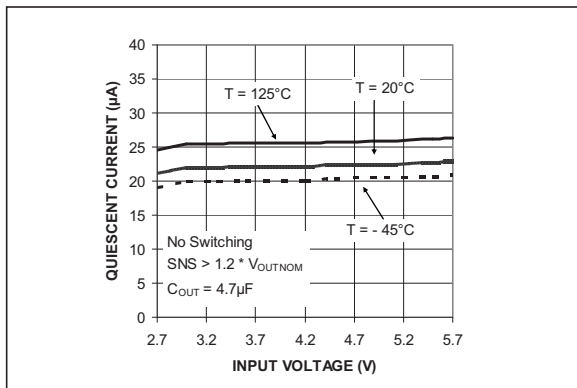
# MIC33153



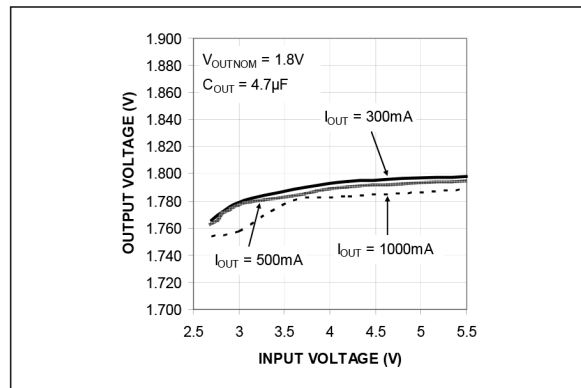
**FIGURE 2-7:** Current-Limit vs. Output Voltage.



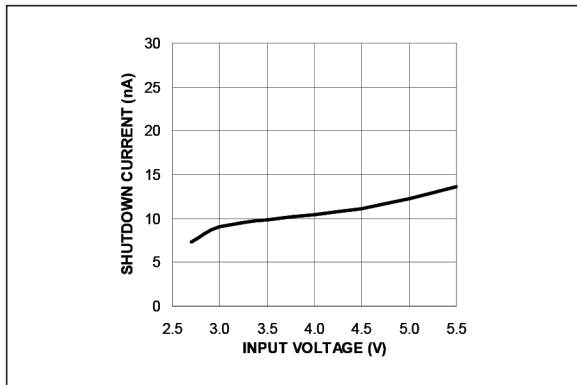
**FIGURE 2-10:** Line Regulation (Light Load).



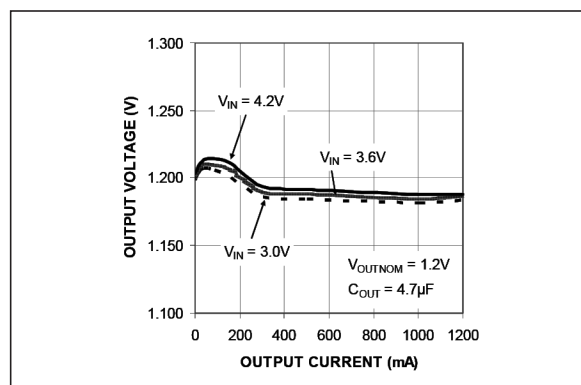
**FIGURE 2-8:** Quiescent Current vs. Input Voltage.



**FIGURE 2-11:** Line Regulation (Heavy Load).

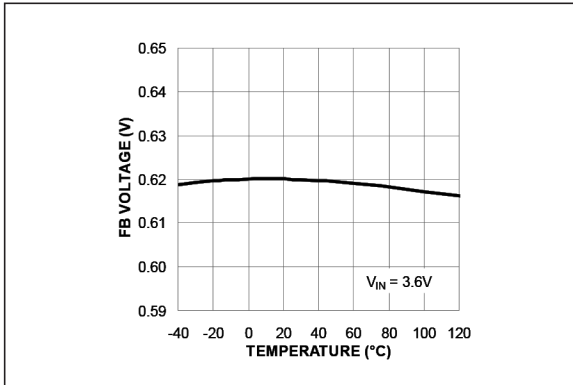


**FIGURE 2-9:** Shutdown Current vs. Input Voltage.

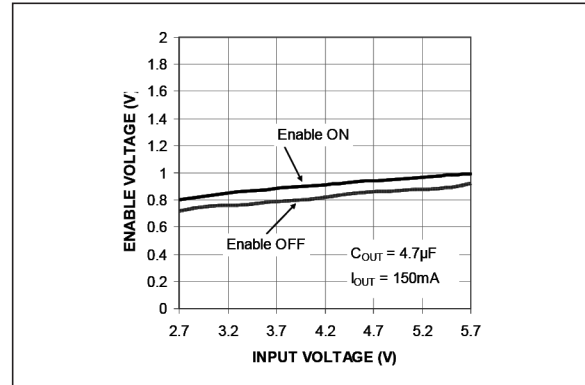


**FIGURE 2-12:** Load Regulation.

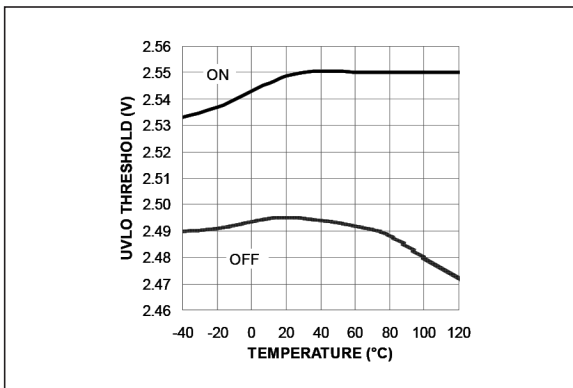




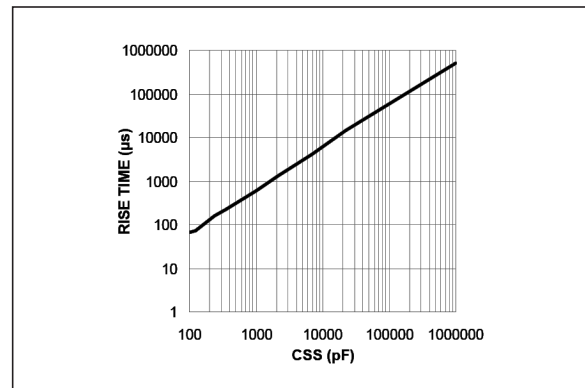
**FIGURE 2-13:** Feedback Voltage vs. Temperature.



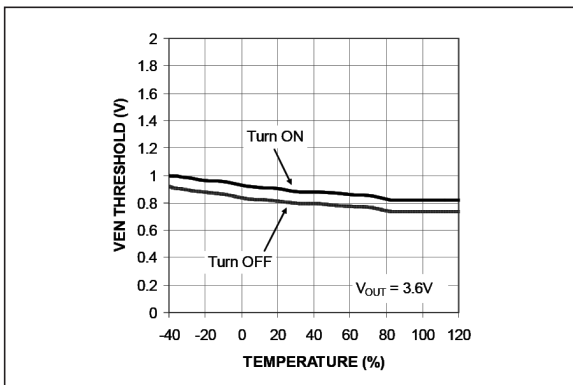
**FIGURE 2-16:** Enable Voltage vs. Input Voltage.



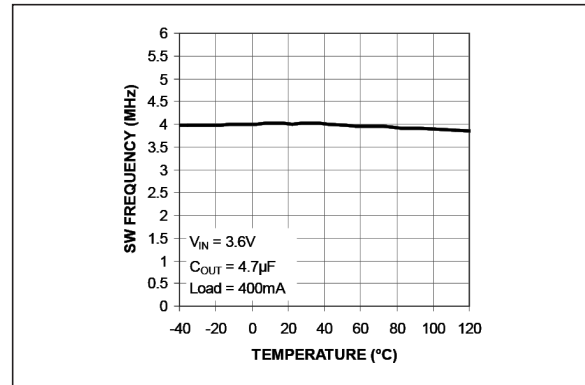
**FIGURE 2-14:** UVLO Threshold vs. Temperature.



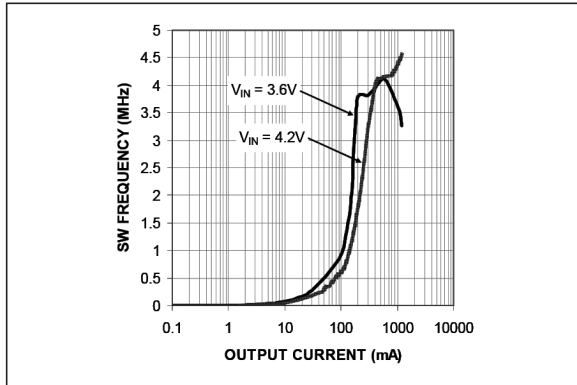
**FIGURE 2-17:**  $V_{OUT}$  Rise Time vs.  $C_{SS}$ .



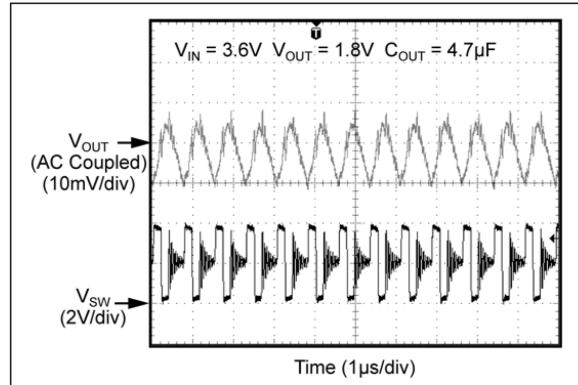
**FIGURE 2-15:** Enable Threshold vs. Temperature.



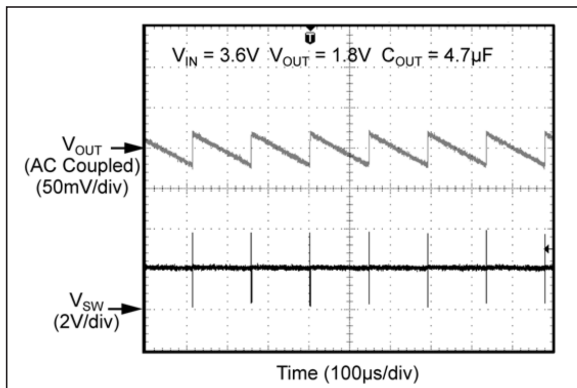
**FIGURE 2-18:** SW Frequency vs. Temperature.



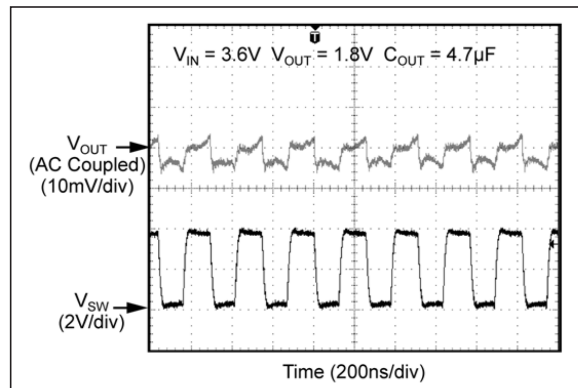
**FIGURE 2-19:** Switching Frequency vs. Output Current.



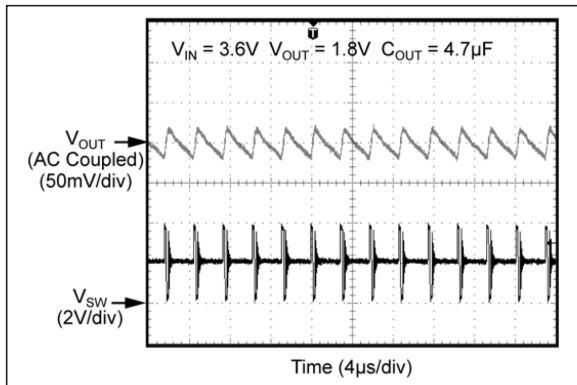
**FIGURE 2-22:** Switching Waveform Discontinuous Mode (Load = 150 mA).



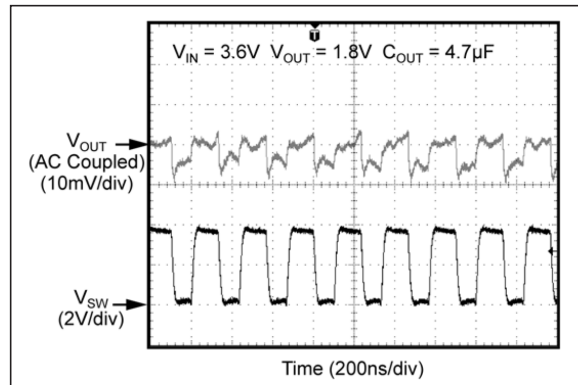
**FIGURE 2-20:** Switching Waveform Discontinuous Mode (Load = 1 mA).



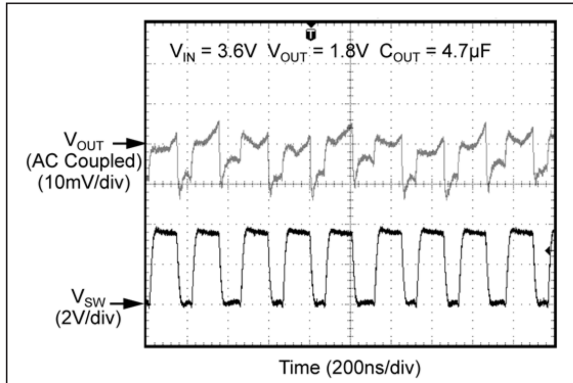
**FIGURE 2-23:** Switching Waveform Continuous Mode (Load = 300 mA).



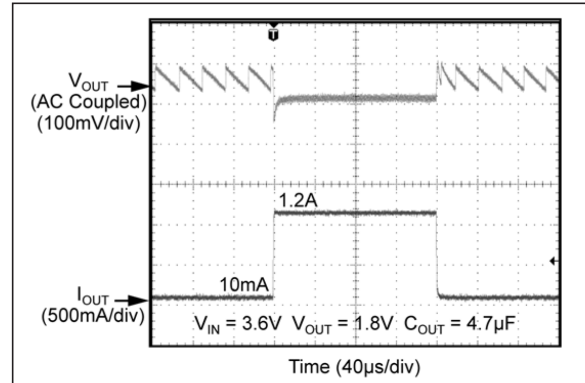
**FIGURE 2-21:** Switching Waveform Discontinuous Mode (Load = 50 mA).



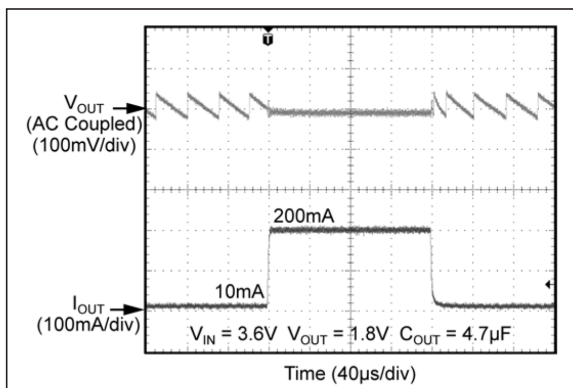
**FIGURE 2-24:** Switching Waveform Continuous Mode (Load = 800 mA).



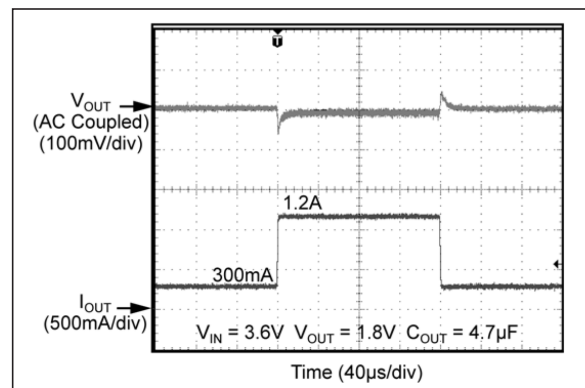
**FIGURE 2-25:** Switching Waveform Continuous Mode (Load = 1.2A).



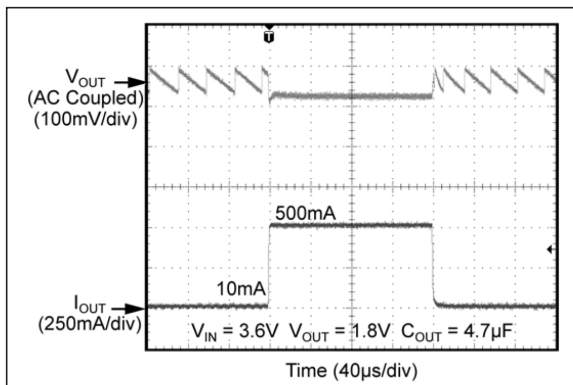
**FIGURE 2-28:** Load Transient (10 mA to 1.2A).



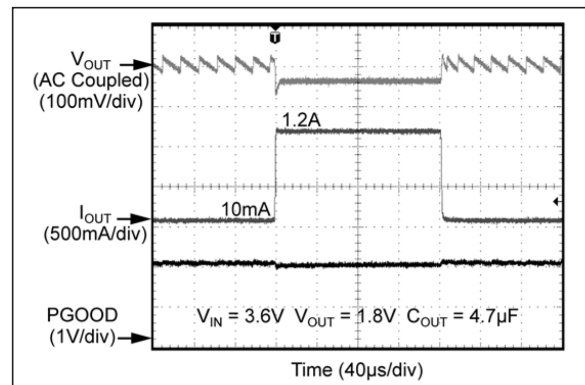
**FIGURE 2-26:** Load Transient (10 mA to 200 mA).



**FIGURE 2-29:** Load Transient (300 mA to 1.2A).

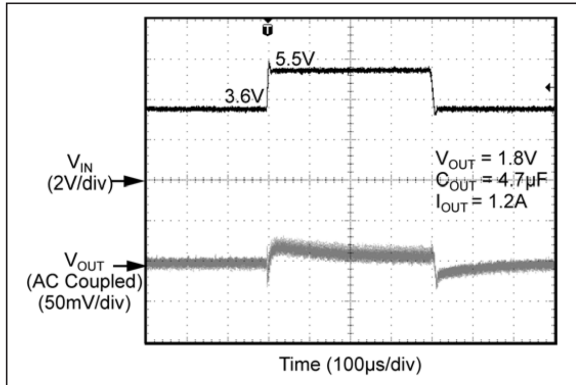


**FIGURE 2-27:** Load Transient (10 mA to 500 mA).

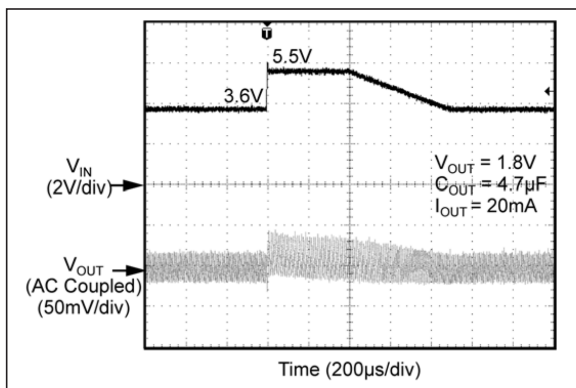


**FIGURE 2-30:** Load Transient (10 mA to 1.2A) with PGOOD.

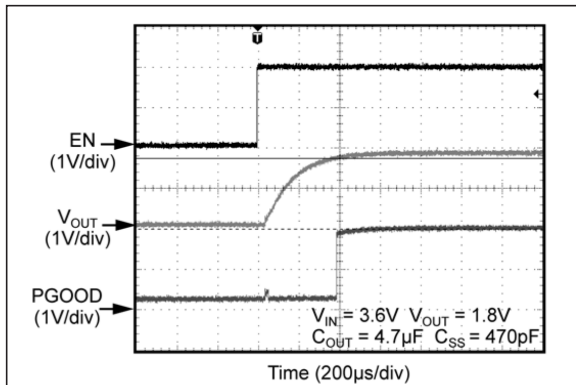
# MIC33153



**FIGURE 2-31:** Line Transient (3.6V to 5.5V) at 1.2A.



**FIGURE 2-32:** Line Transient (3.6V to 5.5V) at 20 mA.



**FIGURE 2-33:** Start-Up with PGOOD ( $C_{SS} = 470 pF$ ).

## 3.0 PIN DESCRIPTIONS

The descriptions of the pins are listed in [Table 3-1](#).

**TABLE 3-1: PIN FUNCTION TABLE**

| Pin Number (Fixed) | Pin Number (Adjustable) | Pin Name | Description   |
|--------------------|-------------------------|----------|---|
| 1                  | 1                       | SS       | Soft-Start: Place a capacitor from this pin to ground to program the soft start time. Do not leave floating, 100 pF minimum $C_{SS}$ is required.           |
| 2                  | 2                       | AGND     | Analog Ground: Connect to central ground point where all high current paths meet ( $C_{IN}$ , $C_{OUT}$ , PGND) for best operation.                         |
| 3                  | 3                       | VIN      | Input Voltage: Connect a capacitor to ground to decouple the noise.   |
| 4                  | 4                       | PGND     | Power Ground.   |
| 5, 6, 7            | 5, 6, 7                 | OUT      | Output Voltage: The output of the regulator. Connect to SNS pin. For adjustable option, connect to feedback resistor network.                               |
| 8, 9, 10           | 8, 9, 10                | SW       | Switch: Internal power MOSFET output switches before inductor.  |
| 11                 | 11                      | EN       | Enable: Logic high enables operation of the regulator. Logic low will shut down the device. Do not leave floating.  |
| 12                 | 12                      | SNS      | Sense: Connect to $V_{OUT}$ as close to output capacitor as possible to sense output voltage.   |
| 13                 | 13                      | PG       | Power Good: Open-drain output for the Power Good (PG) indicator. Use a pull-up resistor from this pin to a voltage source to detect a power good condition. |
| 14                 | —                       | NC       | Not internally connected.   |
| —                  | 14                      | FB       | Feedback: Connect a resistor divider from the output to ground to set the output voltage.   |

# MIC33153

## 4.0 FUNCTIONAL DESCRIPTION

### 4.1 VIN

The input supply (VIN) provides power to the internal MOSFETs for the switch mode regulator along with the internal control circuitry. The VIN operating range is 2.7V to 5.5V so an input capacitor, with a minimum voltage rating of 6.3V, is recommended. Due to the high switching speed, a minimum 2.2  $\mu$ F bypass capacitor placed close to VIN and the power ground (PGND) pin is required.

### 4.2 EN

A logic high signal on the enable pin activates the output voltage of the device. A logic low signal on the enable pin deactivates the output and reduces supply current to 0.01  $\mu$ A. MIC33153 features external soft-start circuitry via the soft-start (SS) pin that reduces inrush current and prevents the output voltage from overshooting at start up. Do not leave the EN pin floating.

### 4.3 SW

The switch (SW) connects directly to one end of the inductor and provides the current path during switching cycles. The other end of the inductor is connected to the load, SNS pin and output capacitor. Due to the high speed switching on this pin, the switch node should be routed away from sensitive nodes whenever possible.

### 4.4 SNS

The sense (SNS) pin is connected to the output of the device to provide feedback to the control circuitry. The SNS connection should be placed close to the output capacitor.

### 4.5 AGND

The analog ground (AGND) is the ground path for the biasing and control circuitry. The current loop for the signal ground should be separate from the power ground (PGND) loop.

### 4.6 PGND

The power ground pin is the ground path for the high current in PWM mode. The current loop for the power ground should be as small as possible and separate from the analog ground (AGND) loop as applicable.

### 4.7 Power Good (PG)

The Power Good (PG) pin is an open-drain output that indicates logic high when the output voltage is typically above 92% of its steady state voltage. When the output

voltage is below 86%, the PG pin indicates logic low. A pull up resistor of more than 10 k $\Omega$  should be connected from PG to V<sub>OUT</sub>.

### 4.8 Soft-Start

The soft-start (SS) pin is used to control the output voltage ramp up time. The approximate equation for the ramp time in milliseconds is:

#### EQUATION 4-1:

$$t(ms) = 270 \times 10^3 \times \ln(10) \times C_{SS}$$

Where:

t = The time in milliseconds

C<sub>SS</sub> = External soft-start capacitance (in Farads)

For example, for a C<sub>SS</sub> = 470 pF, T<sub>RISE</sub> ~ 0.3 ms or 300  $\mu$ s. See [Section 2.0, Typical Performance Curves](#) for a graphical guide. The minimum recommended value for C<sub>SS</sub> is 100 pF.

### 4.9 FB

The feedback (FB) pin is provided for the adjustable voltage option (no internal connection for fixed options). This is the control input for programming the output voltage. A resistor divider network is connected to this pin from the output and is compared to the internal 0.62V reference within the regulation loop.

The output voltage can be programmed between 0.65V and 3.6V using the following equation:

#### EQUATION 4-2:

$$V_{OUT} = V_{REF} \left( 1 + \frac{R1}{R2} \right)$$

Where:

R1 = Top resistor

R2 = Bottom resistor

## 5.0 APPLICATIONS INFORMATION

The MIC33153 is a high performance DC-to-DC step down regulator offering a small solution size. With the HyperLight Load<sup>®</sup> switching scheme, the MIC33153 is able to maintain high efficiency throughout the entire load range while providing ultra-fast load transient response. The following sections provide additional device application information.

### 5.1 Input Capacitor

A 2.2µF ceramic capacitor or greater should be placed close to the VIN pin and PGND pin for bypassing. A Murata GRM188R60J475ME84D, size 0603, 4.7 µF ceramic capacitor is recommended based upon performance, size, and cost. A X5R or X7R temperature rating is recommended for the input capacitor. Y5V temperature rating capacitors, aside from losing most of their capacitance over temperature, can also become resistive at high frequencies. This reduces their ability to filter out high frequency noise.

### 5.2 Output Capacitor

The MIC33153 is designed for use with a 2.2 µF or greater ceramic output capacitor. Increasing the output capacitance will lower output ripple and improve load transient response but could also increase solution size or cost. A low equivalent series resistance (ESR) ceramic output capacitor such as the Murata GRM188R60J475ME84D, size 0603, 4.7 µF ceramic capacitor is recommended based upon performance, size, and cost. Both the X7R or X5R temperature rating capacitors are recommended. The Y5V and Z5U temperature rating capacitors are not recommended due to their wide variation in capacitance over temperature and increased resistance at high frequencies.

### 5.3 Compensation

The MIC33153 is designed to be stable with a 4.7 µF ceramic (X5R) output capacitor.

### 5.4 Duty Cycle

The typical maximum duty cycle of the MIC33153 is 80%.

### 5.5 Efficiency Considerations

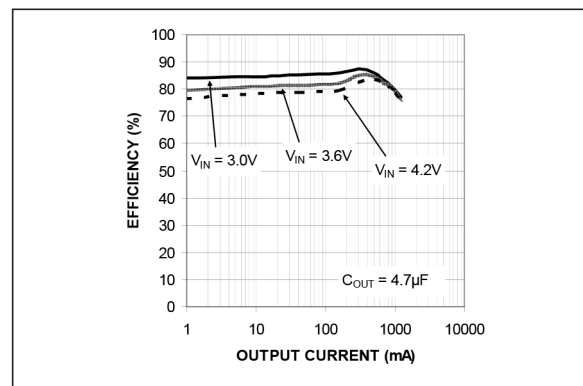
Efficiency is defined as the amount of useful output power, divided by the amount of power supplied.

### EQUATION 5-1:

$$\eta = \left( \frac{V_{OUT} \times I_{OUT}}{V_{IN} \times I_{IN}} \right) \times 100$$

Maintaining high efficiency serves two purposes. It reduces power dissipation in the power supply, reducing the need for heat sinks and thermal design considerations and it reduces consumption of current for battery powered applications. Reduced current draw from a battery increases the devices operating time which is critical in hand held devices.

There are two types of losses in switching converters: DC losses and switching losses. DC losses are simply the power dissipation of  $I^2R$ . Power is dissipated in the high-side switch during the on cycle. Power loss is equal to the high-side MOSFET  $R_{DS(ON)}$  multiplied by the switch current squared. During the off cycle, the low-side N-channel MOSFET conducts, also dissipating power. Device operating current also reduces efficiency. The product of the quiescent (operating) current and the supply voltage represents another DC loss. The current required driving the gates on and off at a constant 4 MHz frequency and the switching transitions make up the switching losses.



**FIGURE 5-1:** Efficiency under Load.

Figure 5-1 shows an efficiency curve. From no load to 100 mA, efficiency losses are dominated by quiescent current losses, gate drive and transition losses. By using the HyperLight Load<sup>®</sup> mode, the MIC33153 is able to maintain high efficiency at low output currents.

Over 100 mA, efficiency loss is dominated by MOSFET  $R_{DS(ON)}$  and inductor losses. Higher input supply voltages will increase the gate to source threshold on the internal MOSFETs, thereby reducing the internal  $R_{DS(ON)}$ . This improves efficiency by reducing DC losses in the device. All but the inductor losses are inherent to the device. In which case, inductor selection becomes increasingly critical in efficiency calculations. As the inductors are reduced in size, the DC resistance (DCR) can become quite significant.

# MIC33153

The DCR losses can be calculated by using Equation 5-2:

## EQUATION 5-2:

$$P_{DCR} = I_{OUT}^2 \times DCR$$

From that, the loss in efficiency due to inductor resistance can be calculated by using Equation 5-3:

## EQUATION 5-3:

$$EfficiencyLoss = \left[ 1 - \left( \frac{V_{OUT} \times I_{OUT}}{V_{OUT} \times I_{OUT} + P_{DCR}} \right) \right] \times 100$$

Efficiency loss due to DCR is minimal at light loads and gains significance as the load is increased. Inductor selection becomes a trade-off between efficiency and size in this case.

The effect of MOSFET voltage drops and DCR losses in conjunction with the maximum duty cycle combine to limit maximum output voltage for a given input voltage. The following graph shows this relationship based on the typical resistive losses in the MIC33153:

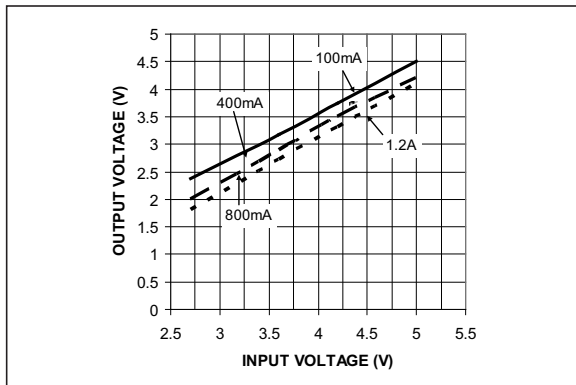


FIGURE 5-2:  $V_{OUT(MAX)}$  vs.  $V_{IN}$ .

## 5.6 HyperLight Load® Mode

The MIC33153 uses a minimum on and off time proprietary control loop. When the output voltage falls below the regulation threshold, the error comparator begins a switching cycle that turns the PMOS on and keeps it on for the duration of the minimum on-time. When the output voltage is over the regulation threshold, the error comparator turns the PMOS off for a minimum off-time. The NMOS acts as an ideal rectifier that conducts when the PMOS is off. Using a NMOS switch instead of a diode allows for lower voltage drop across the switching device when it is on. The asynchronous switching combination between the PMOS and the NMOS allows the control loop to work in discontinuous mode for light load operations. In discontinuous mode, MIC33153 works in pulse frequency modulation (PFM) to regulate the output. As the output current increases, the switching frequency increases. This improves the efficiency of the MIC33153 during light load currents. As the load current increases, the MIC33153 goes into continuous conduction mode (CCM) at a constant frequency of 4 MHz. The equation to calculate the load when the MIC33153 goes into continuous conduction mode may be approximated by the following Equation 5-4:

## EQUATION 5-4:

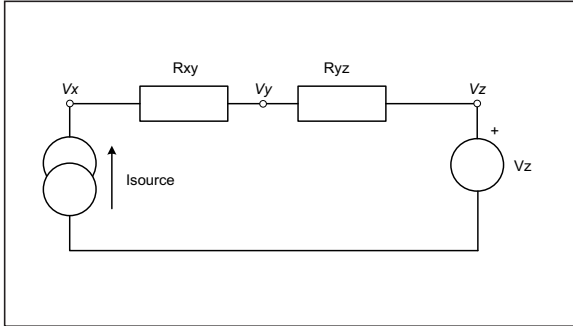
$$I_{LOAD} = \left( \frac{(V_{IN} - V_{OUT}) \times D}{2L \times f} \right)$$

As shown in the above equation, the load at which MIC33153 transitions from HyperLight Load® mode to PWM mode is a function of the input voltage ( $V_{IN}$ ), output voltage ( $V_{OUT}$ ), duty cycle ( $D$ ), inductance ( $L$ ) and frequency ( $f$ ). For example, if  $V_{IN} = 3.6V$ ,  $V_{OUT} = 1.8V$ ,  $D = 0.5$ ,  $f = 4$  MHz and the internal inductance of MIC33153 is  $0.47 \mu H$ , then the device will enter HyperLight Load® mode or PWM mode at approximately 200 mA.

## 5.7 Power Dissipation Considerations

As with all power devices, the ultimate current rating of the output is limited by the thermal properties of the package and the PCB it is mounted on. There is a simple, Ohm's law type relationship between thermal resistance, power dissipation, and temperature which are analogous to an electrical circuit:





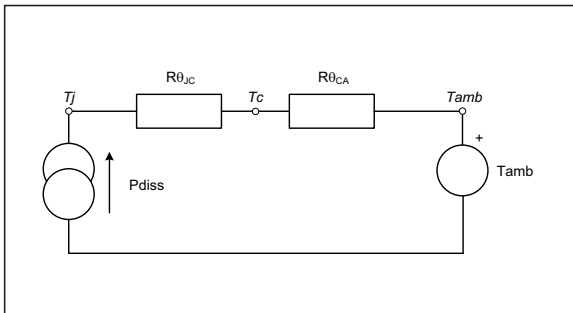
**FIGURE 5-3:** Electrical Circuit Analogous to the Thermal Relief.

From this simple circuit  $V_X$  can be calculated if  $I_{SOURCE}$ ,  $V_Z$  and the resistor values,  $R_{XY}$  and  $R_{YZ}$  are known, using the Equation 5-5:

**EQUATION 5-5:**

$$V_X = I_{SOURCE} \times (R_{XY} + R_{YZ}) + V_Z$$

Thermal circuits can be considered using these same rules and can be drawn similarly replacing current sources with power dissipation (in Watts), resistance with thermal resistance (in °C/W) and voltage sources with temperature (in °C):



**FIGURE 5-4:** Thermal Relief Circuit.

Now replacing the variables in the equation for  $V_X$ , we can find the junction temperature ( $T_J$ ) from power dissipation, ambient temperature and the known thermal resistance of the PCB ( $R_{\theta_{CA}}$ ) and the package ( $R_{\theta_{JC}}$ ):

**EQUATION 5-6:**

$$T_J = P_{DISS} \times (R_{\theta_{JC}} + R_{\theta_{CA}}) + T_{AMB}$$

As can be seen in Figure 5-4, total thermal resistance  $R_{\theta_{JA}} = R_{\theta_{JC}} + R_{\theta_{CA}}$ . This can also be calculated using Equation 5-6:

**EQUATION 5-7:**

$$T_J = P_{DISS} \times (R_{\theta_{JA}}) + T_{AMB}$$

Because effectively all of the power loss in the converter is dissipated within the MIC33153 package,  $P_{DISS}$  can be calculated by using Equation 5-8:

**EQUATION 5-8:**

$$P_{DISS} = P_{OUT} \times \left( \frac{1}{\eta} - 1 \right)$$

Where:

$\eta =$  Efficiency taken from Efficiency Curves

$R_{\theta_{JC}}$  and  $R_{\theta_{JA}}$  are found in the Section “Operating Ratings ¶” of the data sheet.

**EXAMPLE:**

A MIC33153 is intended to drive a 1A load at 1.8V and is placed on a printed circuit board which has a ground plane area of at least 25 mm square. The voltage source is a Li-ion battery with a lower operating threshold of 3V and the ambient temperature of the assembly can be up to 50°C.

Summary of variables:

- $I_{OUT} = 1A$
- $V_{OUT} = 1.8V$
- $V_{IN} = 3V$  to  $4.2V$
- $T_{AMB} = 50^\circ C$
- $R_{\theta_{JA}} = 55^\circ C/W$

$\eta @ 1A = 80\%$  (worst case with  $V_{IN} = 4.2V$ ) See Section 2.0, Typical Performance Curves.

## EQUATION 5-9:

$$P_{DISS} = 1.8 \times 1 \times \left( \frac{1}{0.80} - 1 \right) = 0.45 W$$

The worst case switch and inductor resistance will increase at higher temperatures, so a margin of 20% can be added to account for this:

## EQUATION 5-10:

$$P_{DISS} = 0.45 \times 1.2 = 0.54 W$$

Therefore:

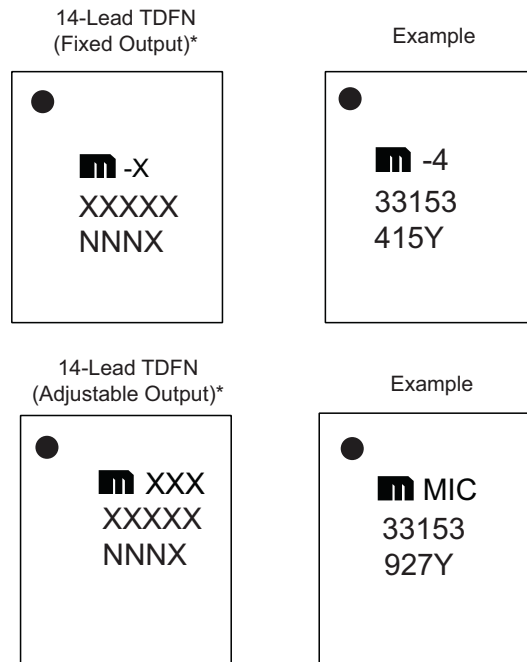
$$T_J = 0.54 W \times (55^\circ C/W) + 50^\circ C$$

$$T_J = 79.7^\circ C$$

This is well below the maximum 125°C.

## 6.0 PACKAGING INFORMATION

### 6.1 Package Marking Information



|  |
|--|
| <p><b>Legend:</b></p> <p>XX...X    Product code or customer-specific information</p> <p>Y         Year code (last digit of calendar year)</p> <p>YY        Year code (last 2 digits of calendar year)</p> <p>WW        Week code (week of January 1 is week '01')</p> <p>NNN       Alphanumeric traceability code</p> <p>(e3)       Pb-free JEDEC® designator for Matte Tin (Sn)</p> <p>*         This package is Pb-free. The Pb-free JEDEC designator (e3) can be found on the outer packaging for this package.</p> <p>●, ▲, ▼ Pin one index is identified by a dot, delta up, or delta down (triangle mark).</p> |
|--|

**Note:** In the event the full Microchip part number cannot be marked on one line, it will be carried over to the next line, thus limiting the number of available characters for customer-specific information. Package may or may not include the corporate logo.

Underbar (    ) and/or Overbar (    ) symbol may not be to scale.

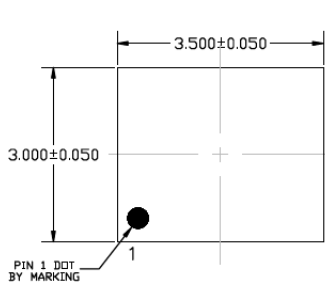
# MIC33153

## 14-Lead TDFN 3.0 mm x 3.5 mm Package Outline and Recommended Land Pattern

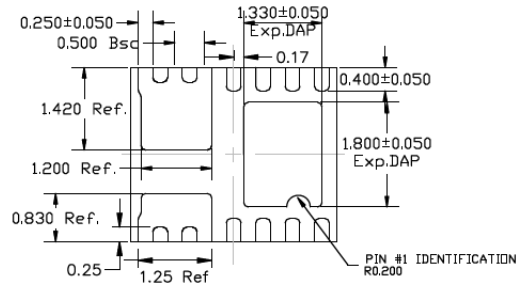
**TITLE**

14 LEAD HJDFN 3.0 x 3.5 mm PACKAGE OUTLINE & RECOMMENDED LAND PATTERN

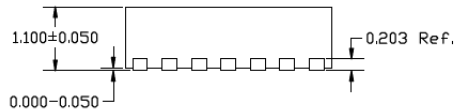
| DRAWING # | HJDFN3035-14LD-PL-1 | UNIT | MM |
|-----------|---------------------|------|----|
|-----------|---------------------|------|----|



TOP VIEW  
NOTE: 1, 2, 3



BOTTOM VIEW  
NOTE: 1, 2, 3



SIDE VIEW  
NOTE: 1, 2, 3

**NOTE:**

1. MAX PACKAGE WARPAGE IS 0.05mm.
2. MAX ALLOWABLE BURR IS 0.076mm IN ALL DIRECTIONS.
3. PIN #1 IS ON TOP WILL BE LASER MARKED.
4. RED CIRCLES IN RECOMMENDED LAND PATTERN ARE THERMAL VIAS. SIZE IS 0.30-0.35mm AND SHOULD BE CONNECTED TO GND FOR MAXIMUM PERFORMANCE
5. GREEN RECTANGLE REPRESENTS (OPTIONAL) SOLDER STENCIL OPENING.
6. PURPLE PADS REPRESENT DIFFERENT POTENTIAL. DO NOT CONNECT TO GND.

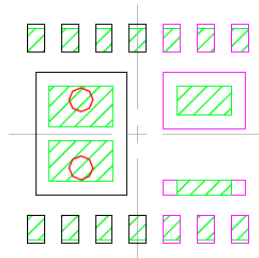
Note: For the most current package drawings, please see the Microchip Packaging Specification located at <http://www.microchip.com/packaging>.

## 14-Lead TDFN 3.0 mm x 3.5 mm Recommended Land Pattern

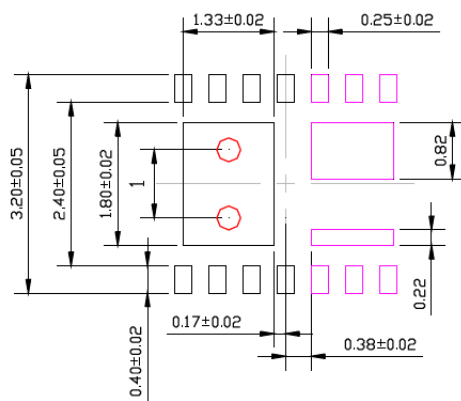
POD-Land Pattern drawing # HJDFN3035-14LD-PL-1

### RECOMMENDED LAND PATTERN

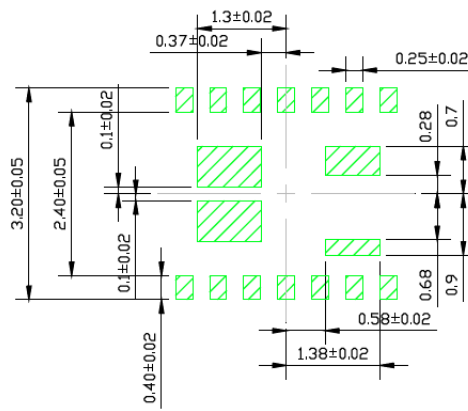
NOTE: 4, 5, 6



STACKED-UP



EXPOSED METAL TRACE



SOLDER STENCIL OPENING

Note: For the most current package drawings, please see the Microchip Packaging Specification located at <http://www.microchip.com/packaging>.

# MIC33153

---

NOTES:

## APPENDIX A: REVISION HISTORY

### Revision A (June 2019)

- Converted Micrel document MIC33153 to Microchip data sheet DS20006223A.
- Minor text changes throughout.

# MIC33153

---

NOTES:



## PRODUCT IDENTIFICATION SYSTEM

To order or obtain information, e.g., on pricing or delivery, contact your local Microchip representative or sales office.

| <u>PART NO.</u>   | <u>-X</u>  | <u>X</u>                   | <u>XX</u>      | <u>-XX</u> | <b>Examples:</b>  |
|---|--|----------------------------|----------------|------------|---|
| Device  | Output Voltage   | Junction Temperature Range | Package Option | Media Type |   |
| <b>Device:</b>  | MIC33153: 4 MHz PWM 1.2A Internal Inductor Buck Regulator with HyperLight Load® and Power Good |                            |                |            | a) MIC33153-4YHJ-TR: 4 MHz PWM 1.2A Internal Inductor Buck Regulator with HyperLight Load® and Power Good, 1.2V Fixed Output Voltage, -40°C to +125°C Junction Temperature Range, Pb-Free, RoHS Compliant, 14-Lead TDFN Package, 5000/Reel  |
| <b>Output Voltage:</b>  | 4 = 1.2V<br>S = 3.3V<br>Blank = Adjustable   |                            |                |            | b) MIC33153-SYHK-TR: 4 MHz PWM 1.2A Internal Inductor Buck Regulator with HyperLight Load® and Power Good, 3.3V Fixed Output Voltage, -40°C to +125°C Junction Temperature Range, Pb-Free, RoHS Compliant, 14-Lead TDFN Package, 5000/Reel  |
| <b>Junction Temperature Range:</b>  | Y = -40°C to +125°C  |                            |                |            | c) MIC33153-YHJ-TR: 4 MHz PWM 1.2A Internal Inductor Buck Regulator with HyperLight Load® and Power Good, Adjustable Output Voltage, -40°C to +125°C Junction Temperature Range, Pb-Free, RoHS Compliant, 14-Lead TDFN Package, 5000/Reel   |
| <b>Package:</b>   | HJ = 14-Lead 3.0 mm x 3.5 mm x 1.1 mm TDFN   |                            |                |            |   |
| <b>Media Type:</b>  | TR = 5000/Reel   |                            |                |            |   |
| <b>Note:</b> Other output voltage options are available. Contact Factory for details. |  |                            |                |            | <b>Note 1:</b> Tape and Reel identifier only appears in the catalog part number description. This identifier is used for ordering purposes and is not printed on the device package. Check with your Microchip Sales Office for package availability with the Tape and Reel option. |

# MIC33153

---

NOTES:

---

---

**Note the following details of the code protection feature on Microchip devices:**

- Microchip products meet the specification contained in their particular Microchip Data Sheet.
- Microchip believes that its family of products is one of the most secure families of its kind on the market today, when used in the intended manner and under normal conditions.
- There are dishonest and possibly illegal methods used to breach the code protection feature. All of these methods, to our knowledge, require using the Microchip products in a manner outside the operating specifications contained in Microchip's Data Sheets. Most likely, the person doing so is engaged in theft of intellectual property.
- Microchip is willing to work with the customer who is concerned about the integrity of their code.
- Neither Microchip nor any other semiconductor manufacturer can guarantee the security of their code. Code protection does not mean that we are guaranteeing the product as “unbreakable.”

Code protection is constantly evolving. We at Microchip are committed to continuously improving the code protection features of our products. Attempts to break Microchip's code protection feature may be a violation of the Digital Millennium Copyright Act. If such acts allow unauthorized access to your software or other copyrighted work, you may have a right to sue for relief under that Act.

---

Information contained in this publication regarding device applications and the like is provided only for your convenience and may be superseded by updates. It is your responsibility to ensure that your application meets with your specifications. MICROCHIP MAKES NO REPRESENTATIONS OR WARRANTIES OF ANY KIND WHETHER EXPRESS OR IMPLIED, WRITTEN OR ORAL, STATUTORY OR OTHERWISE, RELATED TO THE INFORMATION, INCLUDING BUT NOT LIMITED TO ITS CONDITION, QUALITY, PERFORMANCE, MERCHANTABILITY OR FITNESS FOR PURPOSE. Microchip disclaims all liability arising from this information and its use. Use of Microchip devices in life support and/or safety applications is entirely at the buyer's risk, and the buyer agrees to defend, indemnify and hold harmless Microchip from any and all damages, claims, suits, or expenses resulting from such use. No licenses are conveyed, implicitly or otherwise, under any Microchip intellectual property rights unless otherwise stated.

### Trademarks

The Microchip name and logo, the Microchip logo, Adaptec, AnyRate, AVR, AVR logo, AVR Freaks, BesTime, BitCloud, chipKIT, chipKIT logo, CryptoMemory, CryptoRF, dsPIC, FlashFlex, flexPWR, HELDO, IGLOO, JukeBlox, KeeLoq, Klear, LANCheck, LinkMD, maXStylus, maXTouch, MediaLB, megaAVR, Microsemi, Microsemi logo, MOST, MOST logo, MPLAB, OptoLyzer, PackeTime, PIC, picoPower, PICSTART, PIC32 logo, PolarFire, Prochip Designer, QTouch, SAM-BA, SenGenuity, SpyNIC, SST, SST Logo, SuperFlash, Symmetricom, SyncServer, Tachyon, TempTrackr, TimeSource, tinyAVR, UNI/O, Vectron, and XMEGA are registered trademarks of Microchip Technology Incorporated in the U.S.A. and other countries.

APT, ClockWorks, The Embedded Control Solutions Company, EtherSynch, FlashTec, Hyper Speed Control, HyperLight Load, IntelliMOS, Libero, motorBench, mTouch, Powermite 3, Precision Edge, ProASIC, ProASIC Plus, ProASIC Plus logo, Quiet-Wire, SmartFusion, SyncWorld, Temux, TimeCesium, TimeHub, TimePictra, TimeProvider, Vite, WinPath, and ZL are registered trademarks of Microchip Technology Incorporated in the U.S.A.

Adjacent Key Suppression, AKS, Analog-for-the-Digital Age, Any Capacitor, AnyIn, AnyOut, BlueSky, BodyCom, CodeGuard, CryptoAuthentication, CryptoAutomotive, CryptoCompanion, CryptoController, dsPICDEM, dsPICDEM.net, Dynamic Average Matching, DAM, ECAN, EtherGREEN, In-Circuit Serial Programming, ICSP, INICnet, Inter-Chip Connectivity, JitterBlocker, KlearNet, KlearNet logo, memBrain, Mindi, MiWi, MPASM, MPF, MPLAB Certified logo, MPLIB, MPLINK, MultiTRAK, NetDetach, Omniscient Code Generation, PICDEM, PICDEM.net, PICKit, PICtail, PowerSmart, PureSilicon, QMatrix, REAL ICE, Ripple Blocker, SAM-ICE, Serial Quad I/O, SMART-I.S., SQI, SuperSwitcher, SuperSwitcher II, Total Endurance, TSHARC, USBCheck, VariSense, ViewSpan, WiperLock, Wireless DNA, and ZENA are trademarks of Microchip Technology Incorporated in the U.S.A. and other countries.

SQTP is a service mark of Microchip Technology Incorporated in the U.S.A.

The Adaptec logo, Frequency on Demand, Silicon Storage Technology, and Symmcom are registered trademarks of Microchip Technology Inc. in other countries.

GestIC is a registered trademark of Microchip Technology Germany II GmbH & Co. KG, a subsidiary of Microchip Technology Inc., in other countries.

All other trademarks mentioned herein are property of their respective companies.

© 2019, Microchip Technology Incorporated, All Rights Reserved.

ISBN: 978-1-5224-4736-8

For information regarding Microchip's Quality Management Systems, please visit [www.microchip.com/quality](http://www.microchip.com/quality).



# MICROCHIP

## Worldwide Sales and Service

### AMERICAS

**Corporate Office**  
2355 West Chandler Blvd.  
Chandler, AZ 85224-6199  
Tel: 480-792-7200  
Fax: 480-792-7277  
Technical Support:  
<http://www.microchip.com/support>  
Web Address:  
[www.microchip.com](http://www.microchip.com)

#### Atlanta

Duluth, GA  
Tel: 678-957-9614  
Fax: 678-957-1455

#### Austin, TX

Tel: 512-257-3370

#### Boston

Westborough, MA  
Tel: 774-760-0087  
Fax: 774-760-0088

#### Chicago

Itasca, IL  
Tel: 630-285-0071  
Fax: 630-285-0075

#### Dallas

Addison, TX  
Tel: 972-818-7423  
Fax: 972-818-2924

#### Detroit

Novi, MI  
Tel: 248-848-4000

#### Houston, TX

Tel: 281-894-5983

#### Indianapolis

Noblesville, IN  
Tel: 317-773-8323  
Fax: 317-773-5453  
Tel: 317-536-2380

#### Los Angeles

Mission Viejo, CA  
Tel: 949-462-9523  
Fax: 949-462-9608  
Tel: 951-273-7800

#### Raleigh, NC

Tel: 919-844-7510

#### New York, NY

Tel: 631-435-6000

#### San Jose, CA

Tel: 408-735-9110  
Tel: 408-436-4270

#### Canada - Toronto

Tel: 905-695-1980  
Fax: 905-695-2078

### ASIA/PACIFIC

**Australia - Sydney**  
Tel: 61-2-9868-6733

**China - Beijing**  
Tel: 86-10-8569-7000

**China - Chengdu**  
Tel: 86-28-8665-5511

**China - Chongqing**  
Tel: 86-23-8980-9588

**China - Dongguan**  
Tel: 86-769-8702-9880

**China - Guangzhou**  
Tel: 86-20-8755-8029

**China - Hangzhou**  
Tel: 86-571-8792-8115

**China - Hong Kong SAR**  
Tel: 852-2943-5100

**China - Nanjing**  
Tel: 86-25-8473-2460

**China - Qingdao**  
Tel: 86-532-8502-7355

**China - Shanghai**  
Tel: 86-21-3326-8000

**China - Shenyang**  
Tel: 86-24-2334-2829

**China - Shenzhen**  
Tel: 86-755-8864-2200

**China - Suzhou**  
Tel: 86-186-6233-1526

**China - Wuhan**  
Tel: 86-27-5980-5300

**China - Xian**  
Tel: 86-29-8833-7252

**China - Xiamen**  
Tel: 86-592-2388138

**China - Zhuhai**  
Tel: 86-756-3210040

### ASIA/PACIFIC

**India - Bangalore**  
Tel: 91-80-3090-4444

**India - New Delhi**  
Tel: 91-11-4160-8631

**India - Pune**  
Tel: 91-20-4121-0141

**Japan - Osaka**  
Tel: 81-6-6152-7160

**Japan - Tokyo**  
Tel: 81-3-6880-3770

**Korea - Daegu**  
Tel: 82-53-744-4301

**Korea - Seoul**  
Tel: 82-2-554-7200

**Malaysia - Kuala Lumpur**  
Tel: 60-3-7651-7906

**Malaysia - Penang**  
Tel: 60-4-227-8870

**Philippines - Manila**  
Tel: 63-2-634-9065

**Singapore**  
Tel: 65-6334-8870

**Taiwan - Hsin Chu**  
Tel: 886-3-577-8366

**Taiwan - Kaohsiung**  
Tel: 886-7-213-7830

**Taiwan - Taipei**  
Tel: 886-2-2508-8600

**Thailand - Bangkok**  
Tel: 66-2-694-1351

**Vietnam - Ho Chi Minh**  
Tel: 84-28-5448-2100

### EUROPE

**Austria - Wels**  
Tel: 43-7242-2244-39  
Fax: 43-7242-2244-393

**Denmark - Copenhagen**  
Tel: 45-4450-2828  
Fax: 45-4485-2829

**Finland - Espoo**  
Tel: 358-9-4520-820

**France - Paris**  
Tel: 33-1-69-53-63-20  
Fax: 33-1-69-30-90-79

**Germany - Garching**  
Tel: 49-8931-9700

**Germany - Haan**  
Tel: 49-2129-3766400

**Germany - Heilbronn**  
Tel: 49-7131-72400

**Germany - Karlsruhe**  
Tel: 49-721-625370

**Germany - Munich**  
Tel: 49-89-627-144-0  
Fax: 49-89-627-144-44

**Germany - Rosenheim**  
Tel: 49-8031-354-560

**Israel - Ra'anana**  
Tel: 972-9-744-7705

**Italy - Milan**  
Tel: 39-0331-742611  
Fax: 39-0331-466781

**Italy - Padova**  
Tel: 39-049-7625286

**Netherlands - Drunen**  
Tel: 31-416-690399  
Fax: 31-416-690340

**Norway - Trondheim**  
Tel: 47-7288-4388

**Poland - Warsaw**  
Tel: 48-22-3325737

**Romania - Bucharest**  
Tel: 40-21-407-87-50

**Spain - Madrid**  
Tel: 34-91-708-08-90  
Fax: 34-91-708-08-91

**Sweden - Gothenberg**  
Tel: 46-31-704-60-40

**Sweden - Stockholm**  
Tel: 46-8-5090-4654

**UK - Wokingham**  
Tel: 44-118-921-5800  
Fax: 44-118-921-5820

## X-ON Electronics

Largest Supplier of Electrical and Electronic Components

*Click to view similar products for [Switching Voltage Regulators](#) category:*

*Click to view products by [Microchip](#) manufacturer:*

Other Similar products are found below :

[FAN53610AUC33X](#) [FAN53611AUC123X](#) [FAN48610BUC33X](#) [FAN48610BUC45X](#) [FAN48617UC50X](#) [R3](#) [430464BB](#) [MIC45116-1YMP-T1](#) [KE177614](#) [MAX809TTR](#) [NCV891234MW50R2G](#) [NCP81103MNTXG](#) [NCP81203PMNTXG](#) [NCP81208MNTXG](#) [NCP81109GMNTXG](#) [SCY1751FCCT1G](#) [NCP81109JMNTXG](#) [AP3409ADNTR-G1](#) [LTM8064IY](#) [LT8315EFE#TRPBF](#) [NCV1077CSTBT3G](#) [XCL207A123CR-G](#) [MPM54304GMN-0002](#) [MPM54304GMN-0003](#) [XDPE132G5CG000XUMA1](#) [DA9121-B0V76](#) [LTC3644IY#PBF](#) [MP8757GL-P](#) [MIC23356YFT-TR](#) [LD8116CGL](#) [HG2269M/TR](#) [OB2269](#) [XD3526](#) [U6215A](#) [U6215B](#) [U6620S](#) [LTC3803ES6#TR](#) [LTC3803ES6#TRM](#) [LTC3412IFE](#) [LT1425IS](#) [MAX25203BATJA/VY+](#) [MAX77874CEWM+](#) [XC9236D08CER-G](#) [ISL95338IRTZ](#) [MP3416GJ-P](#) [BD9S201NUX-CE2](#) [MP5461GC-Z](#) [MPQ4415AGQB-Z](#) [MPQ4590GS-Z](#) [MCP1603-330IMC](#)