

## 1A, Low Voltage, Low Dropout Regulator with Reversed-Battery Protection

### Features

- Fixed and Adjustable Output Voltages to 1.24V
- 410 mV Typical Dropout at 1A Load
  - Best Recommended for 3.0V to 2.5V Conversion
  - Best Recommended for 2.5V to 1.8V Conversion
- 1A Minimum Guaranteed Output Current
- 1% Initial Accuracy
- Low Ground Current
- Current-Limiting and Thermal-Shutdown Protection
- Reversed-Battery and Reversed-Leakage Protection
- Fast Transient Response
- Low Profile SOT-223 Package
- Power SO-8 Package

### Applications

- LDO Linear Regulator for PC Add-In Cards
- High-Efficiency Linear Power Supplies
- SMPS Post Regulator
- Multimedia and PC Processor Supplies
- Battery Chargers
- Low Voltage Microcontrollers and Digital Logic

### General Description

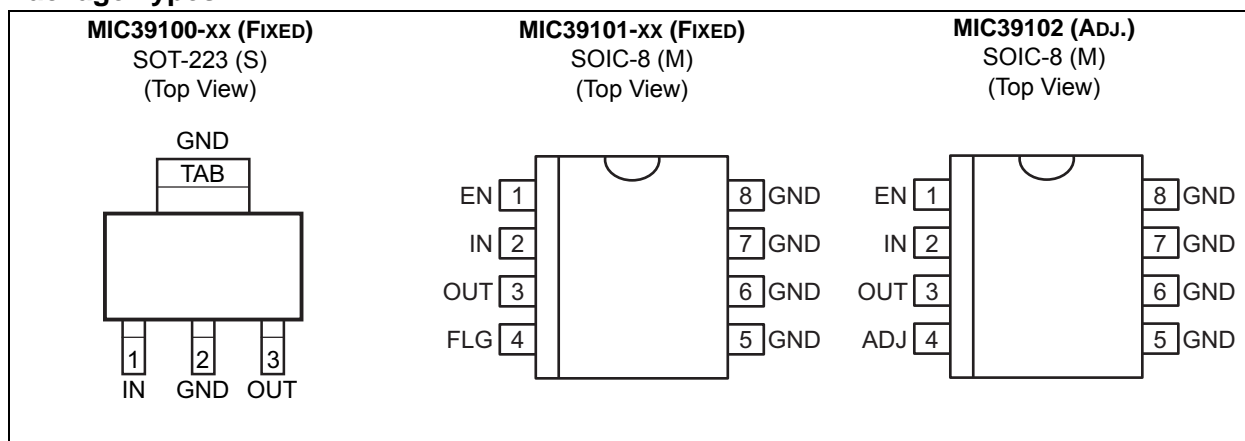
The MIC39100, MIC39101, and MIC39102 are 1A low dropout linear voltage regulators that provide low voltage, high current output from an extremely small package. The MIC39100/1/2 offers extremely low dropout (typically 410 mV at 1A) and low ground current (typically 11 mA at 1A).

The MIC39100 is a fixed output regulator offered in the SOT-223 package. The MIC39101 and MIC39102 are fixed and adjustable regulators, respectively, in a thermally enhanced 8-lead SOIC package.

The MIC39100/1/2 is ideal for PC add-in cards that need to convert from standard 5V to 3.3V, 3.3V to 2.5V, or 2.5V to 1.8V. A guaranteed maximum dropout voltage of 630 mV over all operating conditions allows the MIC39100/1/2 to provide 2.5V from a supply as low as 3.13V and 1.8V from a supply as low as 2.43V.

The MIC39100/1/2 is fully protected with overcurrent limiting, thermal-shutdown, and reverse-battery protection. Fixed voltages of 5.0V, 3.3V, 2.5V, and 1.8V are available on MIC39100/1 with adjustable output voltages to 1.24V on MIC39102.

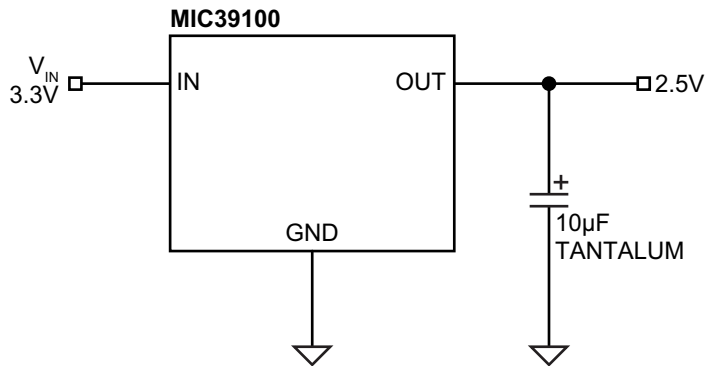
### Package Types



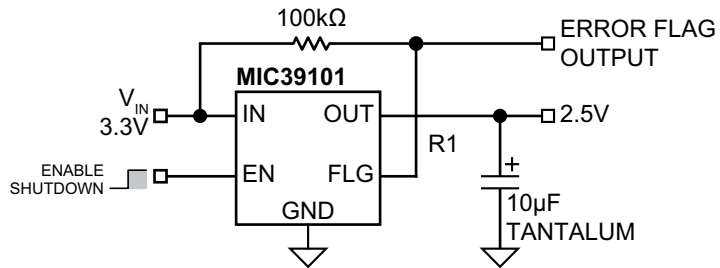
# MIC39100/1/2

## Typical Application Circuits

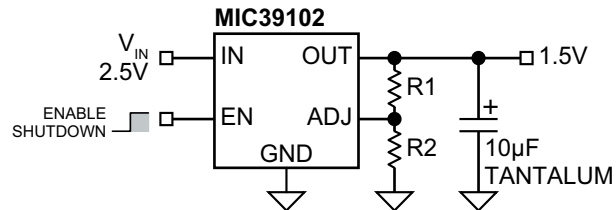
### 2.5V/1A Regulator



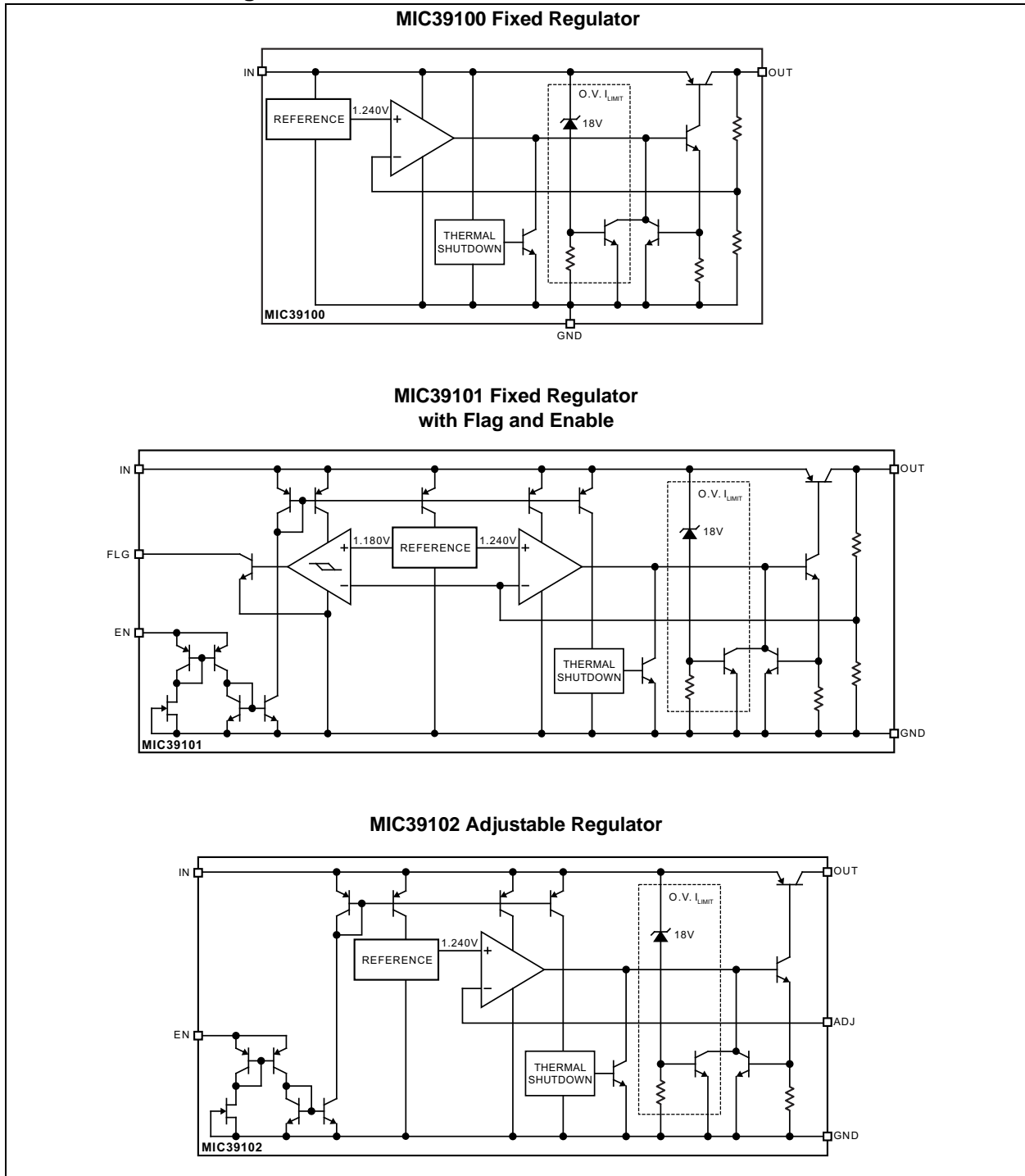
### 2.5V/1A Regulator with Error Flag



### 1.5V/1A Adjustable Regulator



## Functional Block Diagrams



# MIC39100/1/2

## 1.0 ELECTRICAL CHARACTERISTICS

### Absolute Maximum Ratings †

Supply Voltage ( $V_{IN}$ ).....	-20V to +20V
Enable Voltage ( $V_{EN}$ ).....	+20V
ESD Rating .....	Note 1
Maximum Power Dissipation ( $P_{D(MAX)}$ ).....	Note 2

### Operating Ratings ‡

Supply Voltage ( $V_{IN}$ ).....	+2.25V to +16V
Enable Voltage ( $V_{EN}$ ).....	+16V

† **Notice:** Stresses above those listed under “Absolute Maximum Ratings” may cause permanent damage to the device. This is a stress rating only and functional operation of the device at those or any other conditions above those indicated in the operational sections of this specification is not intended. Exposure to maximum rating conditions for extended periods may affect device reliability.

‡ **Notice:** The device is not guaranteed to function outside its operating ratings.

**Note 1:** Devices are ESD sensitive. Handling precautions are recommended. Human body model, 1.5 kΩ in series with 100 pF.

**2:**  $P_{D(MAX)} = (T_{J(MAX)} - T_A) \div \theta_{JA}$ , where  $\theta_{JA}$  depends upon the printed circuit layout (see [Application Information](#)).

**TABLE 1-1: ELECTRICAL CHARACTERISTICS**

**Electrical Characteristics:**  $V_{IN} = V_{OUT} + 1V$ ;  $V_{EN} = 2.25V$ ;  $T_J = +25^\circ C$ , **bold** values indicate  $-40^\circ C \leq T_J \leq +125^\circ C$ , unless noted. [Note 1](#)

Parameter	Symbol	Min.	Typ.	Max.	Units	Conditions
Output Voltage	$V_{OUT}$	-1	—	1	%	$I_{OUT} = 10\text{ mA}$
		<b>-2</b>	—	<b>2</b>		$10\text{ mA} \leq I_{OUT} \leq 1\text{ A}$ , $V_{OUT} + 1V \leq V_{IN} \leq 8V$
Line Regulation	—	—	0.06	0.5	%	$I_{OUT} = 10\text{ mA}$ , $V_{OUT} + 1V \leq V_{IN} \leq 16V$
Load Regulation	—	—	0.2	1	%	$V_{IN} = V_{OUT} + 1V$ , $10\text{ mA} \leq I_{OUT} \leq 1\text{ A}$
Output Voltage Temperature Coefficient	$\Delta V_{OUT} / \Delta T$	—	40	100	ppm/°C	<a href="#">Note 2</a>
Dropout Voltage, <a href="#">Note 3</a>	$V_{DO}$	—	140	200 <b>250</b>	mV	$I_{OUT} = 100\text{ mA}$ , $\Delta V_{OUT} = -1\%$
		—	275	—		$I_{OUT} = 500\text{ mA}$ , $\Delta V_{OUT} = -1\%$
		—	300	<b>500</b>		$I_{OUT} = 750\text{ mA}$ , $\Delta V_{OUT} = -1\%$
		—	410	550 <b>630</b>		$I_{OUT} = 1\text{ A}$ , $\Delta V_{OUT} = -1\%$
Ground Current, <a href="#">Note 4</a>	$I_{GND}$	—	400	—	μA	$I_{OUT} = 100\text{ mA}$ , $V_{IN} = V_{OUT} + 1V$
		—	4	—	mA	$I_{OUT} = 500\text{ mA}$ , $V_{IN} = V_{OUT} + 1V$
		—	6.5	—		$I_{OUT} = 750\text{ mA}$ , $V_{IN} = V_{OUT} + 1V$
		—	11	<b>20</b>		$I_{OUT} = 1\text{ A}$ , $V_{IN} = V_{OUT} + 1V$
Current Limit	$I_{OUT(LIM)}$	—	1.8	2.5	A	$V_{OUT} = 0V$ , $V_{IN} = V_{OUT} + 1V$
<b>Enable Input</b>						
Enable Input Voltage	$V_{EN}$	—	—	<b>0.8</b>	V	Logic LOW (Off)
		<b>2.25</b>	—	—		Logic HIGH (On)

**TABLE 1-1: ELECTRICAL CHARACTERISTICS (CONTINUED)**

**Electrical Characteristics:**  $V_{IN} = V_{OUT} + 1V$ ;  $V_{EN} = 2.25V$ ;  $T_J = +25^\circ C$ , **bold** values indicate  $-40^\circ C \leq T_J \leq +125^\circ C$ , unless noted. [Note 1](#)

Parameter	Symbol	Min.	Typ.	Max.	Units	Conditions
Enable Input Current	$I_{EN}$	1	15	30	$\mu A$	$V_{EN} = 2.25V$
		—	—	<b>75</b>		
		—	—	2		$V_{EN} = 0.8V$
		—	—	<b>4</b>		
<b>Flag Output</b>						
Output Leakage Voltage	$I_{FLG(LEAK)}$	—	0.01	1	$\mu A$	$V_{OH} = 16V$
				<b>2</b>		
Output Low Voltage	$V_{FLG(DO)}$	—	210	300	mV	$V_{IN} = 2.250V$ , $I_{OL} = 250 \mu A$ , <a href="#">Note 5</a>
				<b>400</b>		
Low Threshold	$V_{FLG}$	93	—	—	%	% of $V_{OUT}$
High Threshold		—	—	99.2		% of $V_{OUT}$
Hysteresis		—	1	—		—
<b>MIC39102 Only</b>						
Reference Voltage	—	1.228	1.240	1.252	V	$I_{OUT} = 10 \text{ mA}$
		<b>1.215</b>		<b>1.265</b>		
		<b>1.203</b>	—	<b>1.277</b>		<a href="#">Note 6</a>
Adjust Pin Bias Current	—	—	40	80	nA	—
				<b>120</b>		
Reference Voltage Temperature Coefficient	—	—	20	—	ppm/ $^\circ C$	—
Adjust Pin Bias Current Temperature Coefficient	—	—	0.1	—	nA/ $^\circ C$	—

**Note 1:** Specification for packaged product only.

- 2:** Output voltage temperature coefficient is  $\Delta V_{OUT(WORST \text{ CASE})} \div (T_{J(MAX)} - T_{J(MIN)})$ , where  $T_{J(MAX)} = +125^\circ C$  and  $T_{J(MIN)} = -40^\circ C$ .
- 3:**  $V_{DO} = V_{IN} - V_{OUT}$  when  $V_{OUT}$  decreases to 99% of its nominal output voltage with  $V_{IN} = V_{OUT} + 1V$ . For output voltages below 2.25V, dropout voltage is the input-to-output voltage differential with the minimum input voltage being 2.25V. Minimum input operating voltage is 2.25V.
- 4:**  $I_{GND}$  is the quiescent current ( $I_{IN} = I_{GND} + I_{OUT}$ ).
- 5:** For a 2.5V device,  $V_{IN} = 2.250V$  (device is in dropout).
- 6:**  $V_{REF} \leq V_{OUT} \leq (V_{IN} - 1V)$ ,  $2.25V \leq V_{IN} \leq 16V$ ,  $10 \text{ mA} \leq I_L \leq 1A$ ,  $T_J = T_{MAX}$ .

# MIC39100/1/2

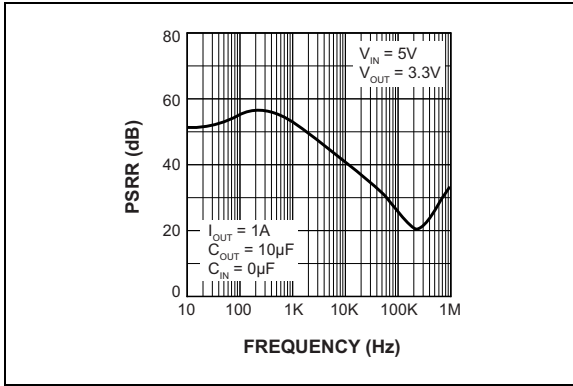
## TEMPERATURE SPECIFICATIONS (Note 1)

Parameters	Sym.	Min.	Typ.	Max.	Units	Conditions
<b>Temperature Ranges</b>						
Junction Operating Temperature Range	$T_J$	-40	—	+125	°C	—
Storage Temperature Range	$T_S$	-65	—	+150	°C	—
Lead Temperature	—	—	—	+260	°C	Soldering, 5s
<b>Package Thermal Resistances</b>						
Thermal Resistance SOT-223	$\theta_{JC}$	—	15	—	°C/W	—
Thermal Resistance SOIC-8	$\theta_{JC}$	—	20	—	°C/W	—

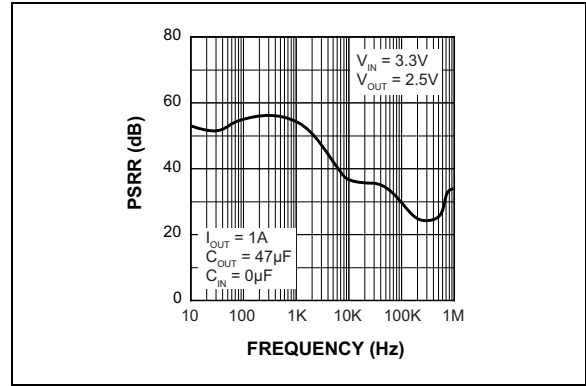
**Note 1:** The maximum allowable power dissipation is a function of ambient temperature, the maximum allowable junction temperature and the thermal resistance from junction to air (i.e.,  $T_A$ ,  $T_J$ ,  $\theta_{JA}$ ). Exceeding the maximum allowable power dissipation will cause the device operating junction temperature to exceed the maximum +125°C rating. Sustained junction temperatures above +125°C can impact the device reliability.

## 2.0 TYPICAL PERFORMANCE CURVES

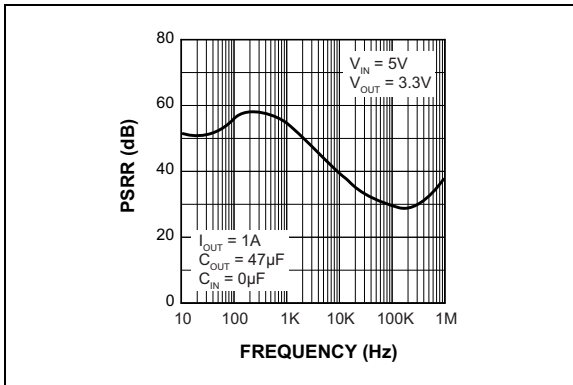
**Note:** The graphs and tables provided following this note are a statistical summary based on a limited number of samples and are provided for informational purposes only. The performance characteristics listed herein are not tested or guaranteed. In some graphs or tables, the data presented may be outside the specified operating range (e.g., outside specified power supply range) and therefore outside the warranted range.



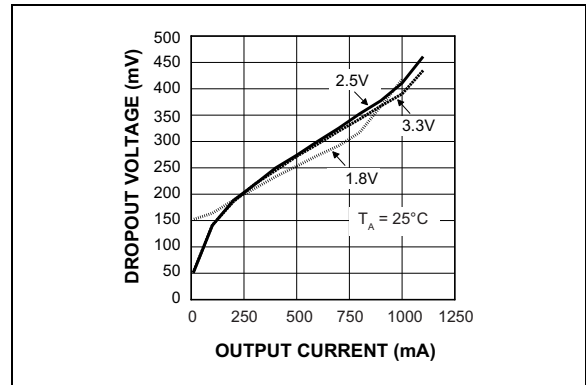
**FIGURE 2-1:** Power Supply Rejection Ratio.



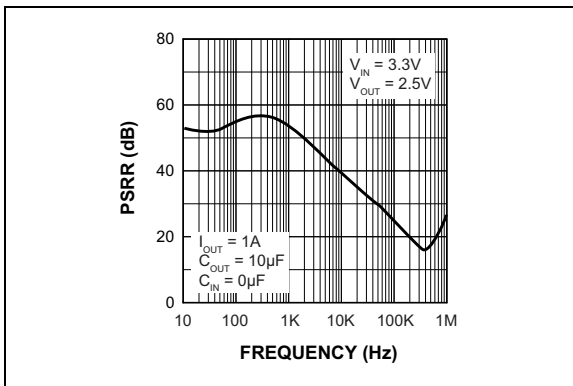
**FIGURE 2-4:** Power Supply Rejection Ratio.



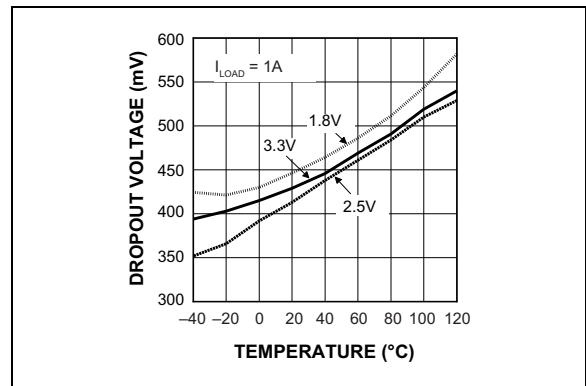
**FIGURE 2-2:** Power Supply Rejection Ratio.



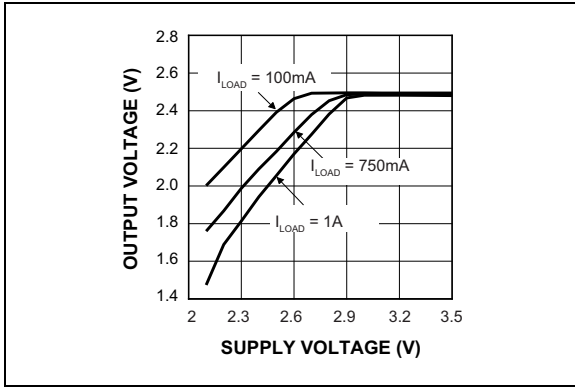
**FIGURE 2-5:** Dropout Voltage vs. Output Current.



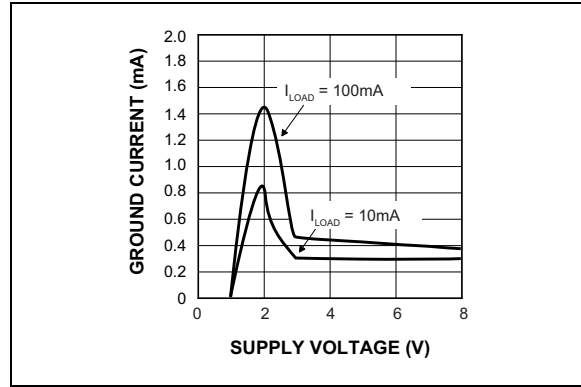
**FIGURE 2-3:** Power Supply Rejection Ratio.



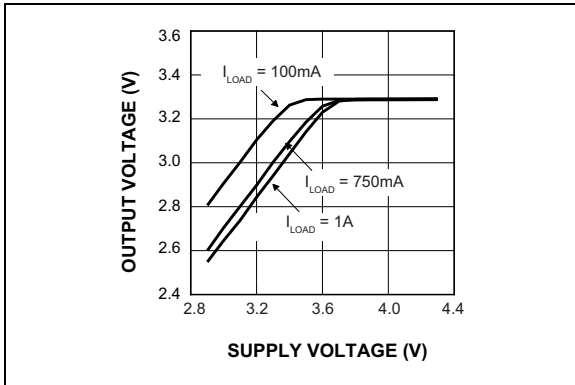
**FIGURE 2-6:** Dropout Voltage vs. Temperature.



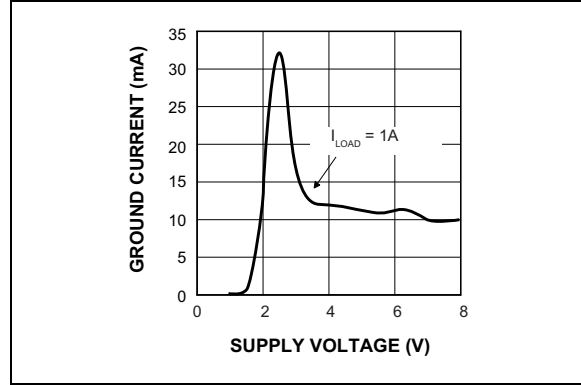
**FIGURE 2-7:** Dropout Characteristics (2.5V).



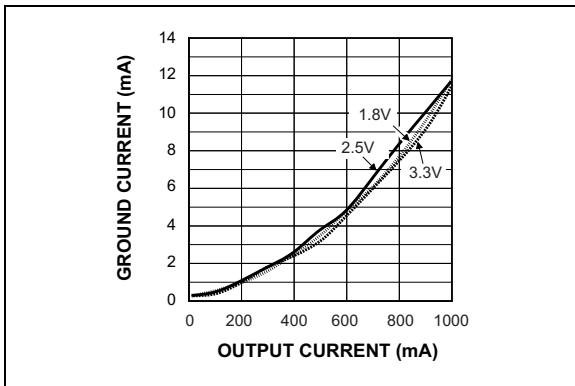
**FIGURE 2-10:** Ground Current vs. Supply Voltage (2.5V).



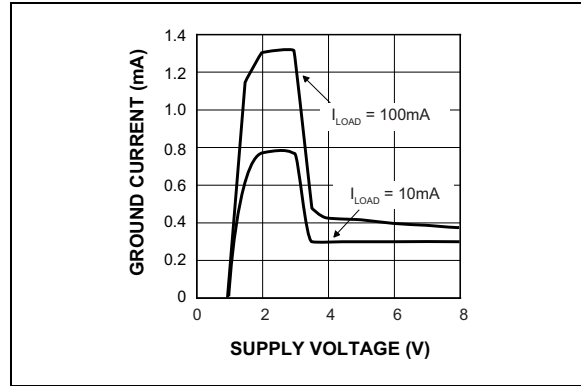
**FIGURE 2-8:** Dropout Characteristics (3.3V).



**FIGURE 2-11:** Ground Current vs. Supply Voltage (2.5V).

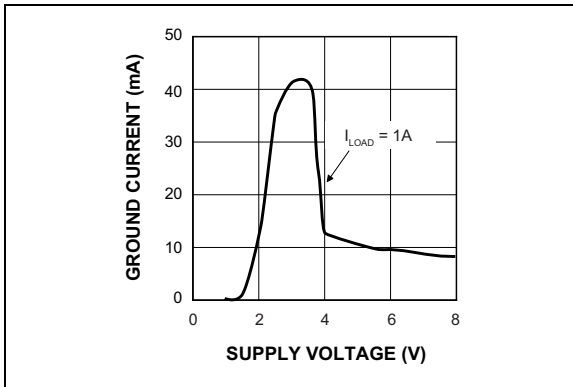


**FIGURE 2-9:** Ground Current vs. Output Current.

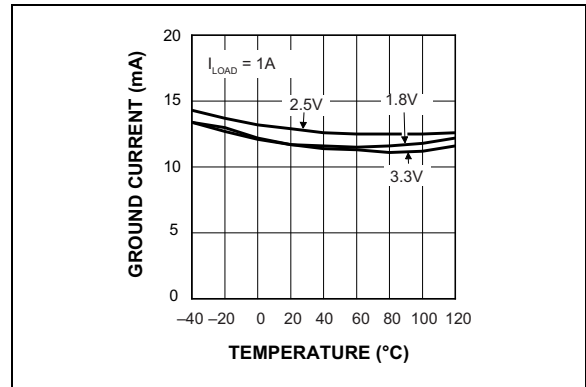


**FIGURE 2-12:** Ground Current vs. Supply Voltage (3.3V).

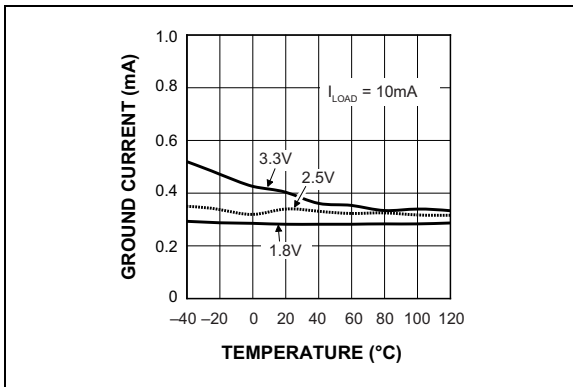




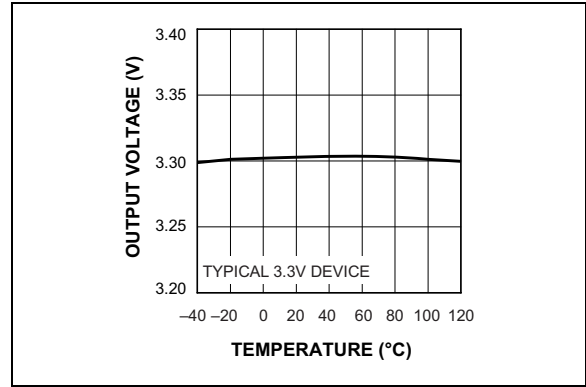
**FIGURE 2-13:** Ground Current vs. Supply Voltage (3.3V).



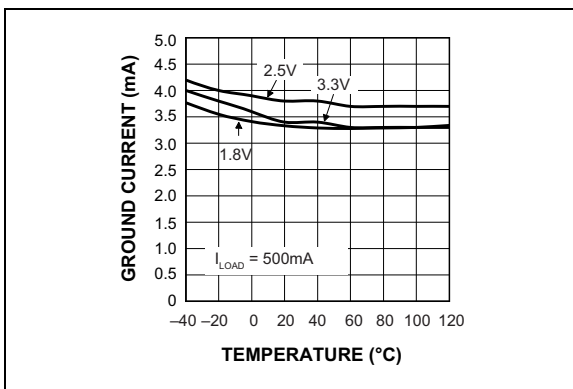
**FIGURE 2-16:** Ground Current vs. Temperature.



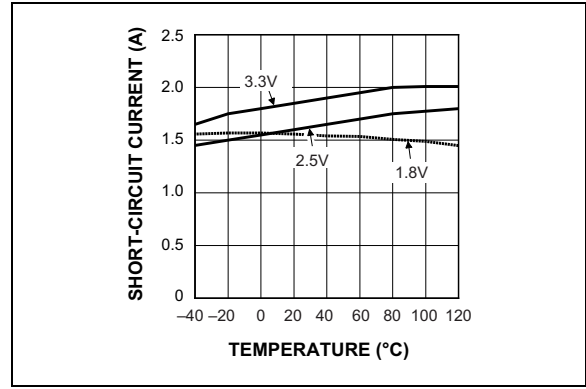
**FIGURE 2-14:** Ground Current vs. Temperature.



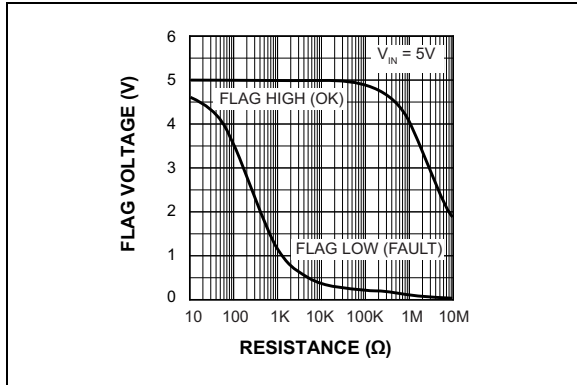
**FIGURE 2-17:** Output Voltage vs. Temperature.



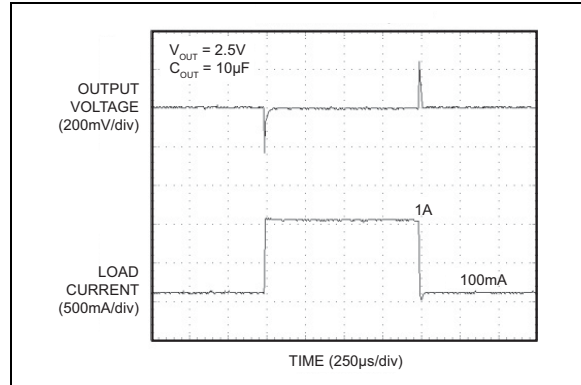
**FIGURE 2-15:** Ground Current vs. Temperature.



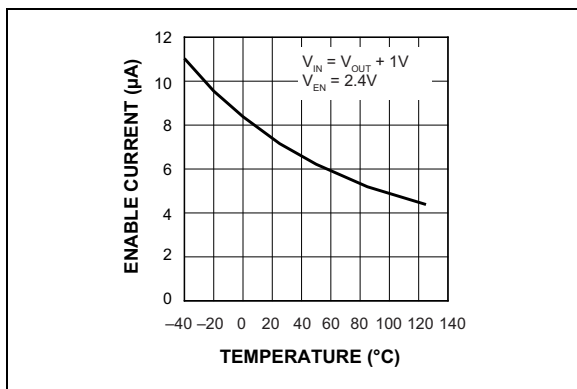
**FIGURE 2-18:** Short-Circuit vs. Temperature.



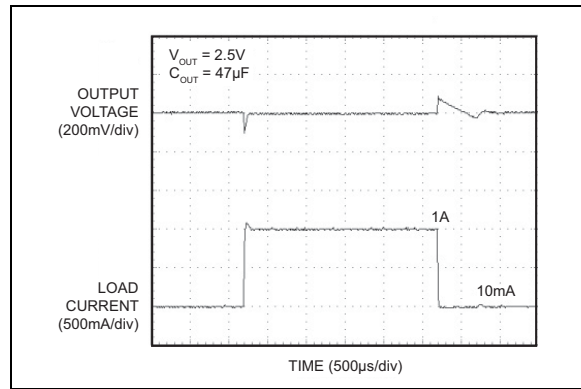
**FIGURE 2-19:** Error Flag Voltage vs. Pull-Up Resistor Value.



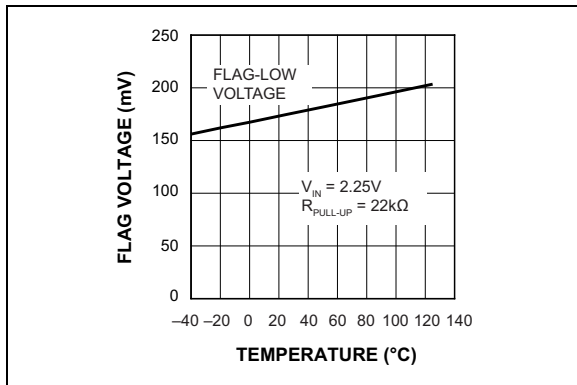
**FIGURE 2-22:** Load Transient Response.



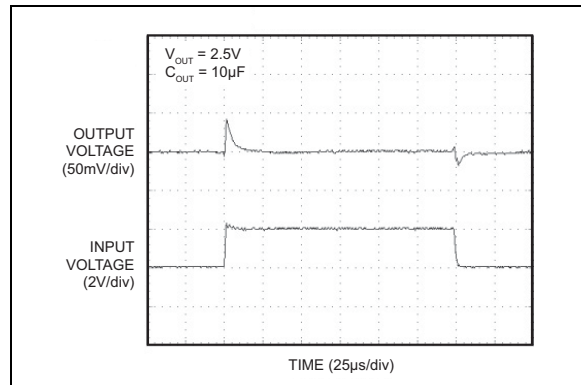
**FIGURE 2-20:** Enable Current vs. Temperature.



**FIGURE 2-23:** Load Transient Response.



**FIGURE 2-21:** Flag-Low Voltage vs. Temperature.



**FIGURE 2-24:** Line Transient Response.

## 3.0 PIN DESCRIPTIONS

The descriptions of the pins are listed in [Table 3-1](#).

**TABLE 3-1: PIN FUNCTION TABLE**

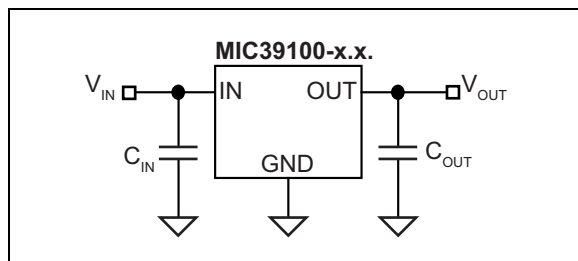
Pin Number MIC39100	Pin Number MIC39101	Pin Number MIC39102	Pin Name	Description
—	1	1	EN	Enable (Input): CMOS-compatible control input. Logic HIGH = enable; logic LOW or OPEN = shutdown.
1	2	2	IN	Supply (Input).
3	3	3	OUT	Regulator Output.
—	4	—	FLG	Flag (Output): Open-collector error flag output. Active LOW = output undervoltage.
—	—	4	ADJ	Adjustable Input: Feedback input. Connect to resistive voltage-divider network.
2, TAB	5, 6, 7, 8	5, 6, 7, 8	GND	Ground.

## 4.0 APPLICATION INFORMATION

The MIC39100/1/2 is a high performance, low dropout voltage regulator suitable for moderate to high current voltage regulator applications. Its 630 mV dropout voltage at full load and over temperature makes it especially valuable in battery-powered systems and as high efficiency noise filters in post-regulator applications. Unlike older NPN-pass transistor designs, where the minimum dropout voltage is limited by the base-to-emitter voltage drop and collector-to-emitter saturation voltage, dropout performance of the PNP output of these devices is limited only by the low  $V_{CE}$  saturation voltage.

A trade-off for the low dropout voltage is a varying base drive requirement that reduces the drive requirement to only 2% of the load current.

The MIC39100/1/2 regulator is fully protected from damage due to fault conditions. Linear current limiting is provided. Output current during overload conditions is constant. Thermal shutdown disables the device when the die temperature exceeds the maximum safe operating temperature. Transient protection allows device (and load) survival even when the input voltage spikes above and below nominal. The output structure of these regulators allows voltages in excess of the desired output voltage to be applied without reverse current flow.



**FIGURE 4-1:** Capacitor Requirements.

### 4.1 Output Capacitor

The MIC39100/1/2 requires an output capacitor to maintain stability and improve transient response. Proper capacitor selection is important to ensure proper operation. The MIC39100/1/2 output capacitor selection is dependent upon the equivalent series resistance (ESR) of the output capacitor to maintain stability. When the output capacitor is 10  $\mu$ F or greater, the output capacitor should have an ESR less than  $2\Omega$ . This will improve transient response as well as promote stability. Ultra-low ESR capacitors ( $<100$  m $\Omega$ ), such as ceramic-chip capacitors, may promote instability. These very low ESR levels may cause an oscillation and/or underdamped transient response. A low-ESR solid tantalum capacitor works extremely well and provides good transient response and stability over temperature. Aluminum electrolytics can also be used, as long as the ESR of the capacitor is  $<2\Omega$ .

The value of the output capacitor can be increased without limit. Higher capacitance values help to improve transient response and ripple rejection and reduce output noise.

### 4.2 Input Capacitor

An input capacitor of 1  $\mu$ F or greater is recommended when the device is more than four inches away from the bulk ac supply capacitance or when the supply is a battery. Small, surface mount, ceramic chip capacitors can be used for bypassing. Larger values will help to improve ripple rejection by bypassing the input to the regulator, further improving the integrity of the output voltage.

### 4.3 Error Flag

The MIC39101 features an error flag (FLG) that monitors the output voltage and signals an error condition when this voltage drops 5% below its expected value. The error flag is an open-collector output that pulls low under fault conditions and may sink up to 10 mA. Low output voltage signifies a number of possible problems, including an overcurrent fault (the device is in current-limit) or low input voltage. The flag output is inoperative during overtemperature conditions. A pull-up resistor from FLG to either  $V_{IN}$  or  $V_{OUT}$  is required for proper operation. For information regarding the minimum and maximum values of pull-up resistance, refer to [Figure 2-19](#).

### 4.4 Enable Input

The MIC39101 and MIC39102 feature an active-HIGH enable input (EN) that allows on/off control of the regulator. Current drain reduces to zero when the device is shutdown, with only microamperes ( $\mu$ A) of leakage current. The EN input has TTL/CMOS-comparable thresholds for simple logic interfacing. EN can be directly tied to  $V_{IN}$  and pulled-up to the maximum supply voltage.

### 4.5 Transient Response and 3.3V to 2.5V or 2.5V to 1.8V Conversion

The MIC39100/1/2 has excellent transient response to variations in input voltage and load current. The device has been designed to respond quickly to load current variations and input voltage variations. Large output capacitors are not required to obtain this performance. A standard 10  $\mu$ F output capacitor, preferably tantalum, is all that is required. Larger values help to improve performance even further.

By virtue of its low dropout voltage, this device does not saturate into dropout as readily as similar NPN-based designs. When converting from 3.3V to 2.5V or 2.5V to 1.8V, the NPN-based regulators are already operating in dropout, with typical dropout requirements of 1.2V or

greater. To convert down to 2.5V or 1.8V without operating in dropout, NPN-based regulators require an input voltage of 3.7V at the very least.

The MIC39100 regulator will provide excellent performance with an input as low as 3.0V or 2.5V respectively. This gives the PNP-based regulators a distinct advantage over older, NPN-based linear regulators.

## 4.6 Minimum Load Current

The MIC39100/1/2 regulator is specified between finite loads. If the output current is too small, leakage currents dominate and the output voltage rises. A 10 mA minimum load current is necessary for proper regulation.

## 4.7 Adjustable Regulator Design

The MIC39102 allows programming the output voltage anywhere between 1.24V and the 16V maximum operating rating of the family. Two resistors are used. Resistors can be quite large, up to 1 MΩ, because of the very high input impedance and low bias current of the sense comparator: The resistor values are calculated by [Equation 4-1](#):

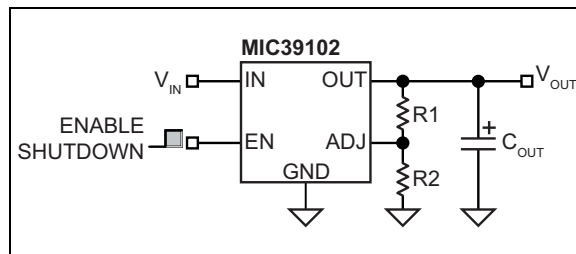
### EQUATION 4-1:

$$R1 = R2 \left( \frac{V_{OUT}}{1.240} - 1 \right)$$

Where:

$V_{OUT}$  Desired output voltage.

Applications with widely varying load currents may scale the resistors to draw the minimum load current required for proper operation ([Figure 4-2](#)).



**FIGURE 4-2:** Adjustable Regulator with Resistors.

### EQUATION 4-2:

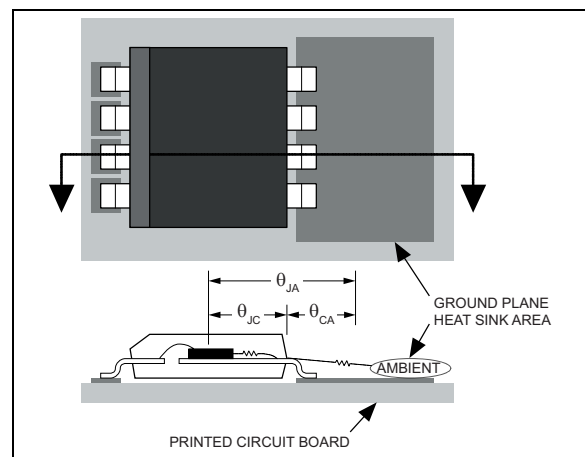
$$V_{OUT} = 1.240V \left( 1 + \frac{R1}{R2} \right)$$

## 4.8 Power SOIC-8 Thermal Characteristics

One of the secrets of the MIC39101/2's performance is its power SO-8 package. Lower thermal resistance means more output current or higher input voltage for a given package size.

Lower thermal resistance is achieved by joining the four ground leads with the die attach paddle to create a single-piece electrical and thermal conductor. This concept has been used by MOSFET manufacturers for years, proving very reliable and cost effective for the user.

Thermal resistance consists of two main elements,  $\theta_{JC}$  (junction-to-case thermal resistance) and  $\theta_{CA}$  (case-to-ambient thermal resistance, see [Figure 4-3](#)).  $\theta_{JC}$  is the resistance from the die to the leads of the package.  $\theta_{CA}$  is the resistance from the leads to the ambient air and it includes  $\theta_{CS}$  (case-to-sink thermal resistance) and  $\theta_{SA}$  (sink-to-ambient thermal resistance).



**FIGURE 4-3:** Thermal Resistance.

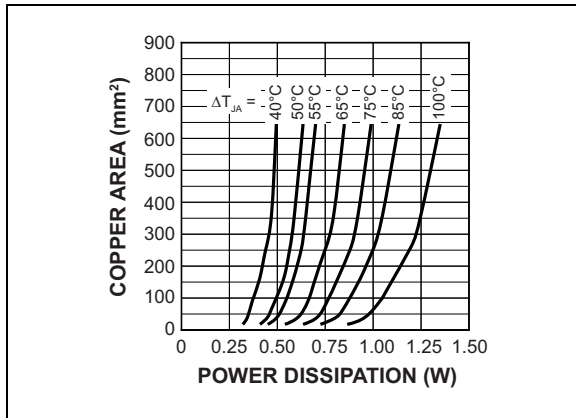
Using the power SOIC-8 reduces the  $\theta_{JC}$  dramatically and allows the user to reduce  $\theta_{CA}$ . The total thermal resistance,  $\theta_{JA}$ , (junction-to-ambient thermal resistance) is the limiting factor in calculating the maximum power dissipation capability of the device. Typically, the power SOIC-8 has a  $\theta_{JC}$  of 20°C/W, which is significantly lower than the standard SOIC-8 (typically 75°C/W).  $\theta_{CA}$  is reduced due to the capability of soldering Pins 5 through 8 directly to a ground plane.

# MIC39100/1/2

This significantly reduces the case-to-sink thermal resistance as well as the sink-to-ambient thermal resistance.

Low dropout linear regulators from Microchip are rated to a maximum junction temperature of +125°C. It is important not to exceed this maximum junction temperature during operation of the device. To prevent this maximum junction temperature from being exceeded, the appropriate ground plane heat sink must be used.

Figure 4-4 shows copper area versus power dissipation with each trace corresponding to a different temperature rise above ambient.



**FIGURE 4-4:** Copper Area vs. Power SOIC Power Dissipation ( $\Delta T_{JA}$ ).

From these curves, the minimum area of copper necessary for the part to operate safely can be determined. The maximum allowable temperature rise must be calculated to determine operation along which curve.

For example, the maximum ambient temperature is 50°C, the  $\Delta T$  is determined as in Equation 4-3:

**EQUATION 4-3:**

$$\Delta T = 125^{\circ}C - 50^{\circ}C = 75^{\circ}C$$

Where:

$\Delta T$	$T_{J(MAX)} - T_{A(MAX)}$
$T_{J(MAX)}$	+125°C
$T_{A(MAX)}$	Max. ambient operating temperature

Using Figure 4-4, the minimum amount of required copper can be determined based on the required power dissipation. Power dissipation in a linear regulator is calculated as in Equation 4-4:

**EQUATION 4-4:**

$$P_D = (V_{IN} - V_{OUT})I_{OUT} + V_{IN} \times I_{GND}$$

Using a 2.5V output device and a 3.3V input at an output current of 1A, the power dissipation is calculated as in Equation 4-5:

**EQUATION 4-5:**

$$P_D = (3.3V - 2.5V)1A + 3.3V \times 11\text{ mA}$$

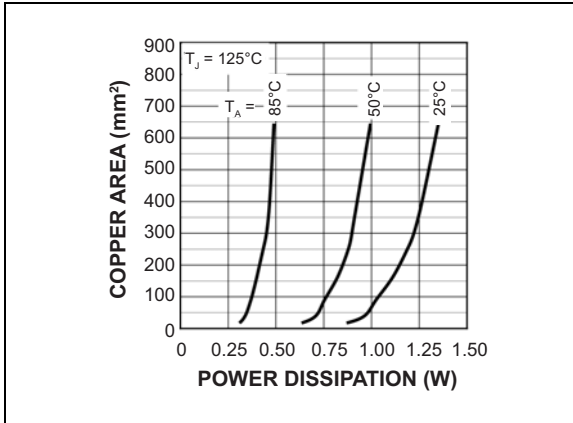
$$= 800\text{ mW} + 36\text{ mW} = 836\text{ mW}$$

From Figure 4-4, the minimum amount of copper required to operate this application at a  $\Delta T$  of 75°C is 160 mm<sup>2</sup>.

## 4.9 Quick Method

Determine the power dissipation requirements for the design along with the maximum ambient temperature at which the device will be operated. Refer to Figure 4-5, which shows safe operating curves for three different ambient temperatures: 25°C, 50°C, and 85°C. From these curves, the minimum amount of copper can be determined by knowing the maximum power dissipation required. If the maximum ambient temperature is 50°C and the power dissipation is as above, 836 mW, the curve in Figure 4-5 shows that the required area of copper is 160 mm<sup>2</sup>.

The  $\theta_{JA}$  of this package is ideally 63°C/W, but it will vary depending upon the availability of copper ground plane to which it is attached.



**FIGURE 4-5:** Copper Area vs. Power SOIC Power Dissipation (T<sub>A</sub>).

# MIC39100/1/2


## 5.0 PACKAGING INFORMATION

### 5.1 Package Marking Information

3-Pin SOT-223\*  
(MIC39100)

 XXXXX  
X.XWNNNP


Example

 39100  
2.58103P

8-Pin SOIC\*  
(MIC39101)

 XXXXX  
-X.XXX  
● WNNN


Example

 39101  
-3.3Y  
● 6987

8-Pin SOIC\*  
(MIC39102)

 XXX  
XXXXXXXX  
● WNNN

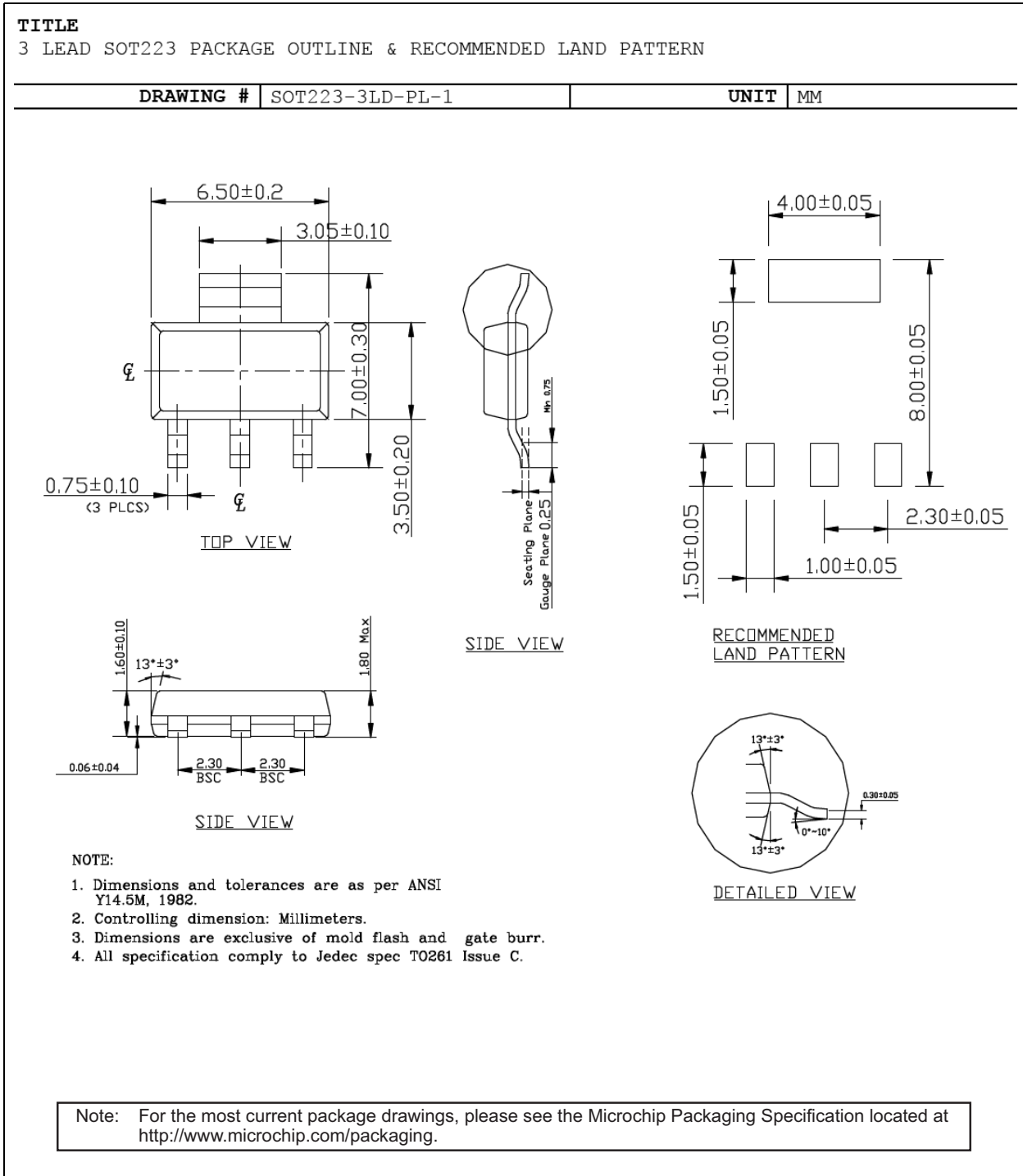
Example

 MIC  
39102YM  
● 3112

<b>Legend:</b>	XX...X	Product code or customer-specific information
	Y	Year code (last digit of calendar year)
	YY	Year code (last 2 digits of calendar year)
	WW	Week code (week of January 1 is week '01')
	NNN	Alphanumeric traceability code
	(e3)	Pb-free JEDEC® designator for Matte Tin (Sn)
	*	This package is Pb-free. The Pb-free JEDEC designator (e3) can be found on the outer packaging for this package.
	●, ▲, ▼	Pin one index is identified by a dot, delta up, or delta down (triangle mark).
<b>Note:</b>	In the event the full Microchip part number cannot be marked on one line, it will be carried over to the next line, thus limiting the number of available characters for customer-specific information. Package may or may not include the corporate logo.	
	Underbar (¯) and/or Overbar (¯) symbol may not be to scale.	



## 3-Lead SOT-223 Package Outline and Recommended Land Pattern



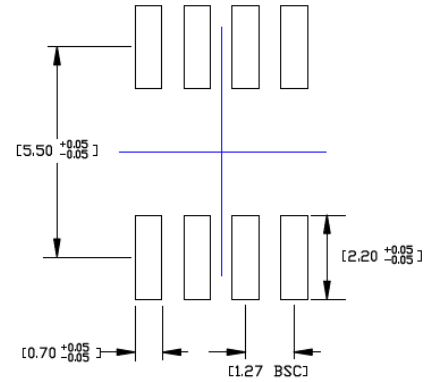
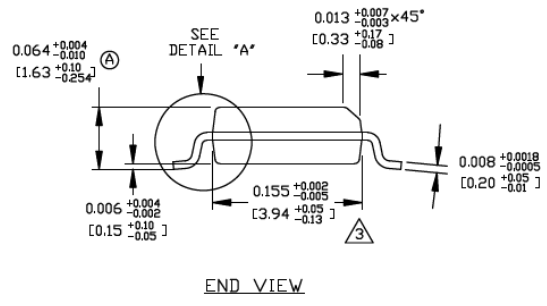
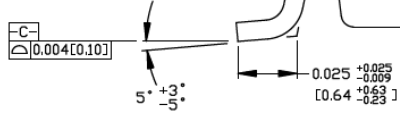
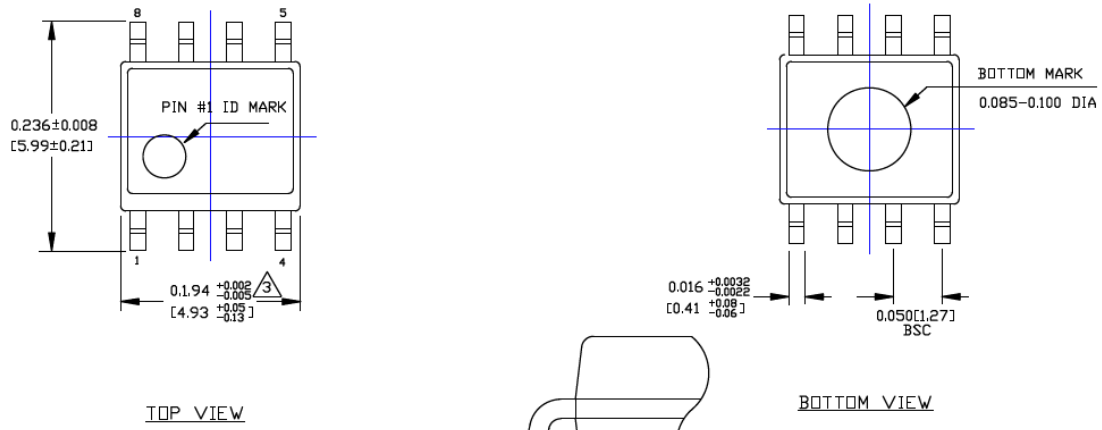
# MIC39100/1/2

## 8-Lead SOIC Package Outline and Recommended Land Pattern

**TITLE**

8 LEAD SOICN PACKAGE OUTLINE & RECOMMENDED LAND PATTERN

DRAWING #	SOICN-8LD-PL-1	UNIT	INCH [MM]
-----------	----------------	------	-----------



- NOTES:**
1. DIMENSIONS ARE IN INCHES[MM].
  2. CONTROLLING DIMENSION: INCHES.
  3. DIMENSION DOES NOT INCLUDE MOLD FLASH OR PROTRUSIONS, EITHER OF WHICH SHALL NOT EXCEED 0.010[0.25] PER SIDE.

Note: For the most current package drawings, please see the Microchip Packaging Specification located at <http://www.microchip.com/packaging>.

## APPENDIX A: REVISION HISTORY

### Revision A (August 2017)

- Converted Micrel document MIC39100/1/2 to Microchip data sheet DS20005834A.
- Minor text changes throughout.



## PRODUCT IDENTIFICATION SYSTEM

To order or obtain information, e.g., on pricing or delivery, contact your local Microchip representative or sales office.

<u>PART NO.</u>	<u>-X.X</u>	<u>X</u>	<u>XX</u>	<u>-XX</u>
Device	Voltage	Temperature	Package	Media Type
<p><b>Device:</b> MIC39100/1/2: 1A, Low Voltage, Low Dropout Regulator</p>				
<p><b>Voltage:</b> 1.8 = 1.8V            2.5 = 2.5V            3.3 = 3.3V            5.0 = 5.0V            &lt;blank&gt;= Adjustable (MIC39102 Only)</p>				
<p><b>Temperature:</b> Y = -40°C to +125°C            W = -40°C to +125°C (with high-melting solder exemption)</p>				
<p><b>Package:</b> M = 8-Lead SOIC            S = 3-Lead SOT-223 (MIC39100 Only)</p>				
<p><b>Media Type:</b> &lt;blank&gt;= 78/Tube (MIC39100)            &lt;blank&gt;= 95/Tube (MIC39101/2)            TR = 2,500/Reel</p>				
<p><b>Examples:</b></p> <p>a) MIC39100-1.8WS: 1A, Low Voltage, Low Dropout Regulator, 1.8V, -40°C to +125°C, 3-Lead SOT-223, 78/Tube</p> <p>b) MIC39100-3.3WS-TR: 1A, Low Voltage, Low Dropout Regulator, 3.3V, -40°C to +125°C, 3-Lead SOT-223, 2,500/Reel</p> <p>c) MIC39101-2.5YM: 1A, Low Voltage, Low Dropout Regulator, 2.5V, -40°C to +125°C, 8-Lead SOIC, 95/Tube</p> <p>d) MIC39101-5.0YM-TR: 1A, Low Voltage, Low Dropout Regulator, 5.0V, -40°C to +125°C, 8-Lead SOIC, 2,500/Reel</p> <p>e) MIC39102YM: 1A, Low Voltage, Low Dropout Regulator, Adjustable Voltage, -40°C to +125°C, 8-Lead SOIC, 95/Tube</p> <p>f) MIC39102YM-TR: 1A, Low Voltage, Low Dropout Regulator, Adjustable Voltage, -40°C to +125°C, 8-Lead SOIC, 2,500/Reel</p> <p><b>Note 1:</b> Tape and Reel identifier only appears in the catalog part number description. This identifier is used for ordering purposes and is not printed on the device package. Check with your Microchip Sales Office for package availability with the Tape and Reel option.</p>				

# MIC39100/1/2

---

NOTES:

---

**Note the following details of the code protection feature on Microchip devices:**

- Microchip products meet the specification contained in their particular Microchip Data Sheet.
- Microchip believes that its family of products is one of the most secure families of its kind on the market today, when used in the intended manner and under normal conditions.
- There are dishonest and possibly illegal methods used to breach the code protection feature. All of these methods, to our knowledge, require using the Microchip products in a manner outside the operating specifications contained in Microchip's Data Sheets. Most likely, the person doing so is engaged in theft of intellectual property.
- Microchip is willing to work with the customer who is concerned about the integrity of their code.
- Neither Microchip nor any other semiconductor manufacturer can guarantee the security of their code. Code protection does not mean that we are guaranteeing the product as “unbreakable.”

Code protection is constantly evolving. We at Microchip are committed to continuously improving the code protection features of our products. Attempts to break Microchip's code protection feature may be a violation of the Digital Millennium Copyright Act. If such acts allow unauthorized access to your software or other copyrighted work, you may have a right to sue for relief under that Act.

---

Information contained in this publication regarding device applications and the like is provided only for your convenience and may be superseded by updates. It is your responsibility to ensure that your application meets with your specifications. MICROCHIP MAKES NO REPRESENTATIONS OR WARRANTIES OF ANY KIND WHETHER EXPRESS OR IMPLIED, WRITTEN OR ORAL, STATUTORY OR OTHERWISE, RELATED TO THE INFORMATION, INCLUDING BUT NOT LIMITED TO ITS CONDITION, QUALITY, PERFORMANCE, MERCHANTABILITY OR FITNESS FOR PURPOSE. Microchip disclaims all liability arising from this information and its use. Use of Microchip devices in life support and/or safety applications is entirely at the buyer's risk, and the buyer agrees to defend, indemnify and hold harmless Microchip from any and all damages, claims, suits, or expenses resulting from such use. No licenses are conveyed, implicitly or otherwise, under any Microchip intellectual property rights unless otherwise stated.

*Microchip received ISO/TS-16949:2009 certification for its worldwide headquarters, design and wafer fabrication facilities in Chandler and Tempe, Arizona; Gresham, Oregon and design centers in California and India. The Company's quality system processes and procedures are for its PIC® MCUs and dsPIC® DSCs, KEELOQ® code hopping devices, Serial EEPROMs, microperipherals, nonvolatile memory and analog products. In addition, Microchip's quality system for the design and manufacture of development systems is ISO 9001:2000 certified.*

**QUALITY MANAGEMENT SYSTEM  
CERTIFIED BY DNV  
= ISO/TS 16949 =**

**Trademarks**

The Microchip name and logo, the Microchip logo, AnyRate, AVR, AVR logo, AVR Freaks, BeaconThings, BitCloud, CryptoMemory, CryptoRF, dsPIC, FlashFlex, flexPWR, Heldo, JukeBlox, KEELOQ, KEELOQ logo, Klear, LANCheck, LINK MD, maXStylus, maXTouch, MediaLB, megaAVR, MOST, MOST logo, MPLAB, OptoLyzer, PIC, picoPower, PICSTART, PIC32 logo, Prochip Designer, QTouch, RightTouch, SAM-BA, SpyNIC, SST, SST Logo, SuperFlash, tinyAVR, UNI/O, and XMEGA are registered trademarks of Microchip Technology Incorporated in the U.S.A. and other countries.

ClockWorks, The Embedded Control Solutions Company, EtherSynch, Hyper Speed Control, HyperLight Load, IntelliMOS, mTouch, Precision Edge, and Quiet-Wire are registered trademarks of Microchip Technology Incorporated in the U.S.A.

Adjacent Key Suppression, AKS, Analog-for-the-Digital Age, Any Capacitor, AnyIn, AnyOut, BodyCom, chipKIT, chipKIT logo, CodeGuard, CryptoAuthentication, CryptoCompanion, CryptoController, dsPICDEM, dsPICDEM.net, Dynamic Average Matching, DAM, ECAN, EtherGREEN, In-Circuit Serial Programming, ICSP, Inter-Chip Connectivity, JitterBlocker, KlearNet, KlearNet logo, Mindi, MiWi, motorBench, MPASM, MPF, MPLAB Certified logo, MPLIB, MPLINK, MultiTRAK, NetDetach, Omniscient Code Generation, PICDEM, PICDEM.net, PICKit, PICTail, PureSilicon, QMatrix, RightTouch logo, REAL ICE, Ripple Blocker, SAM-ICE, Serial Quad I/O, SMART-I.S., SQI, SuperSwitcher, SuperSwitcher II, Total Endurance, TSHARC, USBCheck, VariSense, ViewSpan, WiperLock, Wireless DNA, and ZENA are trademarks of Microchip Technology Incorporated in the U.S.A. and other countries.

SQTP is a service mark of Microchip Technology Incorporated in the U.S.A.

Silicon Storage Technology is a registered trademark of Microchip Technology Inc. in other countries.

GestIC is a registered trademark of Microchip Technology Germany II GmbH & Co. KG, a subsidiary of Microchip Technology Inc., in other countries.

All other trademarks mentioned herein are property of their respective companies.

© 2017, Microchip Technology Incorporated, All Rights Reserved.  
ISBN: 978-1-5224-2098-9



# MICROCHIP

## Worldwide Sales and Service

### AMERICAS

**Corporate Office**  
2355 West Chandler Blvd.  
Chandler, AZ 85224-6199  
Tel: 480-792-7200  
Fax: 480-792-7277  
Technical Support:  
<http://www.microchip.com/support>  
Web Address:  
[www.microchip.com](http://www.microchip.com)

**Atlanta**  
Duluth, GA  
Tel: 678-957-9614  
Fax: 678-957-1455

**Austin, TX**  
Tel: 512-257-3370

**Boston**  
Westborough, MA  
Tel: 774-760-0087  
Fax: 774-760-0088

**Chicago**  
Itasca, IL  
Tel: 630-285-0071  
Fax: 630-285-0075

**Dallas**  
Addison, TX  
Tel: 972-818-7423  
Fax: 972-818-2924

**Detroit**  
Novi, MI  
Tel: 248-848-4000

**Houston, TX**  
Tel: 281-894-5983

**Indianapolis**  
Noblesville, IN  
Tel: 317-773-8323  
Fax: 317-773-5453  
Tel: 317-536-2380

**Los Angeles**  
Mission Viejo, CA  
Tel: 949-462-9523  
Fax: 949-462-9608  
Tel: 951-273-7800

**Raleigh, NC**  
Tel: 919-844-7510

**New York, NY**  
Tel: 631-435-6000

**San Jose, CA**  
Tel: 408-735-9110  
Tel: 408-436-4270

**Canada - Toronto**  
Tel: 905-695-1980  
Fax: 905-695-2078

### ASIA/PACIFIC

**Asia Pacific Office**  
Suites 3707-14, 37th Floor  
Tower 6, The Gateway  
Harbour City, Kowloon

**Hong Kong**  
Tel: 852-2943-5100  
Fax: 852-2401-3431

**Australia - Sydney**  
Tel: 61-2-9868-6733  
Fax: 61-2-9868-6755

**China - Beijing**  
Tel: 86-10-8569-7000  
Fax: 86-10-8528-2104

**China - Chengdu**  
Tel: 86-28-8665-5511  
Fax: 86-28-8665-7889

**China - Chongqing**  
Tel: 86-23-8980-9588  
Fax: 86-23-8980-9500

**China - Dongguan**  
Tel: 86-769-8702-9880

**China - Guangzhou**  
Tel: 86-20-8755-8029

**China - Hangzhou**  
Tel: 86-571-8792-8115  
Fax: 86-571-8792-8116

**China - Hong Kong SAR**  
Tel: 852-2943-5100  
Fax: 852-2401-3431

**China - Nanjing**  
Tel: 86-25-8473-2460  
Fax: 86-25-8473-2470

**China - Qingdao**  
Tel: 86-532-8502-7355  
Fax: 86-532-8502-7205

**China - Shanghai**  
Tel: 86-21-3326-8000  
Fax: 86-21-3326-8021

**China - Shenyang**  
Tel: 86-24-2334-2829  
Fax: 86-24-2334-2393

**China - Shenzhen**  
Tel: 86-755-8864-2200  
Fax: 86-755-8203-1760

**China - Wuhan**  
Tel: 86-27-5980-5300  
Fax: 86-27-5980-5118

**China - Xian**  
Tel: 86-29-8833-7252  
Fax: 86-29-8833-7256

### ASIA/PACIFIC

**China - Xiamen**  
Tel: 86-592-2388138  
Fax: 86-592-2388130

**China - Zhuhai**  
Tel: 86-756-3210040  
Fax: 86-756-3210049

**India - Bangalore**  
Tel: 91-80-3090-4444  
Fax: 91-80-3090-4123

**India - New Delhi**  
Tel: 91-11-4160-8631  
Fax: 91-11-4160-8632

**India - Pune**  
Tel: 91-20-3019-1500

**Japan - Osaka**  
Tel: 81-6-6152-7160  
Fax: 81-6-6152-9310

**Japan - Tokyo**  
Tel: 81-3-6880-3770  
Fax: 81-3-6880-3771

**Korea - Daegu**  
Tel: 82-53-744-4301  
Fax: 82-53-744-4302

**Korea - Seoul**  
Tel: 82-2-554-7200  
Fax: 82-2-558-5932 or  
82-2-558-5934

**Malaysia - Kuala Lumpur**  
Tel: 60-3-6201-9857  
Fax: 60-3-6201-9859

**Malaysia - Penang**  
Tel: 60-4-227-8870  
Fax: 60-4-227-4068

**Philippines - Manila**  
Tel: 63-2-634-9065  
Fax: 63-2-634-9069

**Singapore**  
Tel: 65-6334-8870  
Fax: 65-6334-8850

**Taiwan - Hsin Chu**  
Tel: 886-3-5778-366  
Fax: 886-3-5770-955

**Taiwan - Kaohsiung**  
Tel: 886-7-213-7830

**Taiwan - Taipei**  
Tel: 886-2-2508-8600  
Fax: 886-2-2508-0102

**Thailand - Bangkok**  
Tel: 66-2-694-1351  
Fax: 66-2-694-1350

### EUROPE

**Austria - Wels**  
Tel: 43-7242-2244-39  
Fax: 43-7242-2244-393

**Denmark - Copenhagen**  
Tel: 45-4450-2828  
Fax: 45-4485-2829

**Finland - Espoo**  
Tel: 358-9-4520-820

**France - Paris**  
Tel: 33-1-69-53-63-20  
Fax: 33-1-69-30-90-79

**France - Saint Cloud**  
Tel: 33-1-30-60-70-00

**Germany - Garching**  
Tel: 49-8931-9700

**Germany - Haan**  
Tel: 49-2129-3766400

**Germany - Heilbronn**  
Tel: 49-7131-67-3636

**Germany - Karlsruhe**  
Tel: 49-721-625370

**Germany - Munich**  
Tel: 49-89-627-144-0  
Fax: 49-89-627-144-44

**Germany - Rosenheim**  
Tel: 49-8031-354-560

**Israel - Ra'anana**  
Tel: 972-9-744-7705

**Italy - Milan**  
Tel: 39-0331-742611  
Fax: 39-0331-466781

**Italy - Padova**  
Tel: 39-049-7625286

**Netherlands - Drunen**  
Tel: 31-416-690399  
Fax: 31-416-690340

**Norway - Trondheim**  
Tel: 47-7289-7561

**Poland - Warsaw**  
Tel: 48-22-3325737

**Romania - Bucharest**  
Tel: 40-21-407-87-50

**Spain - Madrid**  
Tel: 34-91-708-08-90  
Fax: 34-91-708-08-91

**Sweden - Gothenberg**  
Tel: 46-31-704-60-40

**Sweden - Stockholm**  
Tel: 46-8-5090-4654

**UK - Wokingham**  
Tel: 44-118-921-5800  
Fax: 44-118-921-5820



## X-ON Electronics

Largest Supplier of Electrical and Electronic Components

*Click to view similar products for [LDO Voltage Regulators](#) category:*

*Click to view products by [Microchip](#) manufacturer:*

Other Similar products are found below :

[AP7363-SP-13](#) [L79M05TL-E](#) [PT7M8202B12TA5EX](#) [TCR3DF185,LM\(CT](#) [TCR3DF24,LM\(CT](#) [TCR3DF285,LM\(CT](#) [TCR3DF31,LM\(CT](#)  
[TCR3DF45,LM\(CT](#) [MP2013GQ-33-Z](#) [059985X](#) [NCP4687DH15T1G](#) [701326R](#) [TCR2EN28,LF\(S](#) [NCV8170AXV250T2G](#)  
[TCR3DF27,LM\(CT](#) [TCR3DF19,LM\(CT](#) [TCR3DF125,LM\(CT](#) [TCR2EN18,LF\(S](#) [AP7315-25W5-7](#) [IFX30081LDVGRNXUMA1](#)  
[NCV47411PAAJR2G](#) [AP2113KTR-G1](#) [AP2111H-1.2TRG1](#) [ZLDO1117QK50TC](#) [AZ1117IH-1.8TRG1](#) [TCR3DG12,LF](#) [MIC5514-3.3YMT-](#)  
[T5](#) [MIC5512-1.2YMT-T5](#) [MIC5317-2.8YM5-T5](#) [SCD7912BTG](#) [NCP154MX180270TAG](#) [SCD33269T-5.0G](#) [NCV8170BMX330TCG](#)  
[NCV8170AMX120TCG](#) [NCP706ABMX300TAG](#) [NCP153MX330180TCG](#) [NCP114BMX075TCG](#) [MC33269T-3.5G](#) [CAT6243-ADJCMT5T](#)  
[TCR3DG33,LF](#) [AP2127N-1.0TRG1](#) [TCR4DG35,LF](#) [LT1117CST-3.3](#) [LT1117CST-5](#) [TAR5S15U\(TE85L,F\)](#) [TAR5S18U\(TE85L,F\)](#)  
[TCR3UG19A,LF](#) [TCR4DG105,LF](#) [NCV8170AMX360TCG](#) [MIC94310-NYMT-T5](#)