



MIC5232

10mA Ultra-Low Quiescent Current μ Cap LDO

General Description

The MIC5232 is an ultra-low quiescent current, low-dropout linear regulator that is capable of operating from a single-cell lithium ion battery. Consuming only 1.8 μ A of quiescent current while operating, the MIC5232 is ideal for stand-by applications like powering real-time clocks or memory in battery operated electronics.

The MIC5232 is capable of providing 10mA of output current and has low output noise, providing a small, efficient solution ideal for any keep-alive application. This includes reverse current protection, keeping reverse leakage ($V_{OUT} > V_{IN}$) down to 20nA.

The MIC5232 is a μ Cap design, operating with very small ceramic output capacitors for stability, reduction of required board space and component cost.

The MIC5232 is available in fixed output voltages in the miniature 6-pin 2mm x 2mm MLF[®] package and thin SOT-23-5 package with an operating junction temperature range of -40°C to 125°C.

Features

- Input voltage range: 2.7V to 7.0V
- Ultra-low Iq: Only 1.8 μ A operating current
- Stable with 0.47 μ F ceramic output capacitor
- Low dropout voltage of 100mV @ 10mA
- Reverse Battery Protection
- High output accuracy:
 - $\pm 2.0\%$ initial accuracy
 - $\pm 3.0\%$ over temperature
- Logic-Level Enable Input
- Miniature 6-pin 2mm x 2mm MLF package
- Lead-Free Thin SOT-23-5 Package
- Tight Load and Line Regulation

Applications

- Real-Time Clock Power Supply
- Stand-by Power Supply
- SRAM Memory Back-up Supply
- Cellular Telephones and Notebook Computers

Typical Application

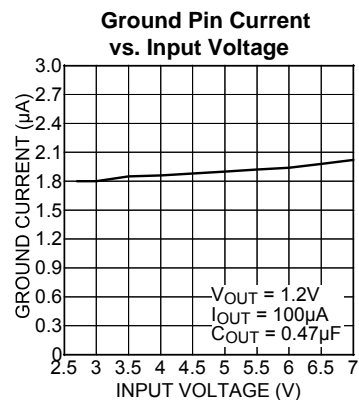
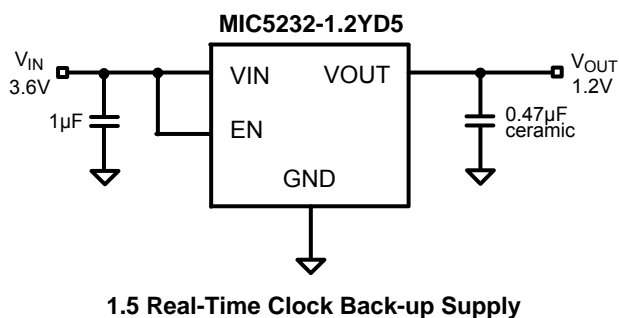

MLF and MicroLeadFrame are registered trademarks of Amkor Technology, Inc.

Micrel Inc. • 2180 Fortune Drive • San Jose, CA 95131 • USA • tel +1 (408) 944-0800 • fax + 1 (408) 474-1000 • <http://www.micrel.com>

Ordering Information

Part Number	Marking Code ⁽¹⁾	Voltage ⁽²⁾	Junction Temperature Range	Package	Lead Finish
MIC5232-1.2YD5	<u>Z</u> A12	1.2V	-40°C to +125°C	TSOT-23-5	Pb-Free
MIC5232-1.8YD5	<u>Z</u> A18	1.8V	-40°C to +125°C	TSOT-23-5	Pb-Free
MIC5232-2.5YD5	<u>Z</u> A25	2.5V	-40°C to +125°C	TSOT-23-5	Pb-Free
MIC5232-2.8YD5	<u>Z</u> A28	2.8V	-40°C to +125°C	TSOT-23-5	Pb-Free
MIC5232-3.3YD5	<u>Z</u> A33	3.3V	-40°C to +125°C	TSOT-23-5	Pb-Free
MIC5232-1.2YML	<u>1</u> <u>2</u> <u>Z</u>	1.2V	-40°C to +125°C	6-Pin 2mm x 2mm MLF ⁽³⁾	Pb-Free
MIC5232-1.8YML	<u>1</u> <u>8</u> <u>Z</u>	1.8V	-40°C to +125°C	6-Pin 2mm x 2mm MLF ⁽³⁾	Pb-Free
MIC5232-2.5YML	<u>2</u> <u>5</u> <u>Z</u>	2.5V	-40°C to +125°C	6-Pin 2mm x 2mm MLF ⁽³⁾	Pb-Free
MIC5232-2.8YML	<u>2</u> <u>8</u> <u>Z</u>	2.8V	-40°C to +125°C	6-Pin 2mm x 2mm MLF ⁽³⁾	Pb-Free
MIC5232-3.3YML	<u>3</u> <u>3</u> <u>Z</u>	3.3V	-40°C to +125°C	6-Pin 2mm x 2mm MLF ⁽³⁾	Pb-Free

Notes:

1. Overbar/Underbar symbol (/) may not be to scale.
2. Other voltages available. Contact Micrel Inc. for more details.
3. MLF is a GREEN RoHS compliant package. Lead finish is NiPdAu. Mold compound is Halogen Free.

Pin Configuration

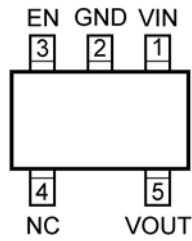

MIC5232-x.xYD5
TSOT-23-5 (D5)

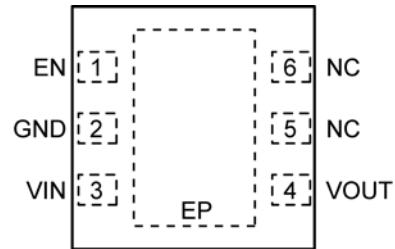

MIC5232-x.xYML
2mm x 2mm MLF® (ML)

Pin Description

Pin Number TSOT-23-5	Pin Number MLF	Pin Name	Pin Name
1	3	VIN	Supply Input.
2	2	GND	Ground.
3	1	EN	Enable Input. Active High. High = on, Low = off. Do not leave floating.
4	5	NC	Not Internally Connected.
5	4	VOUT	Output (10mA output current).
-	6	NC	Not Internally Connected.
-	EP	ePad	Exposed pad connected-to-ground.

Block Diagram

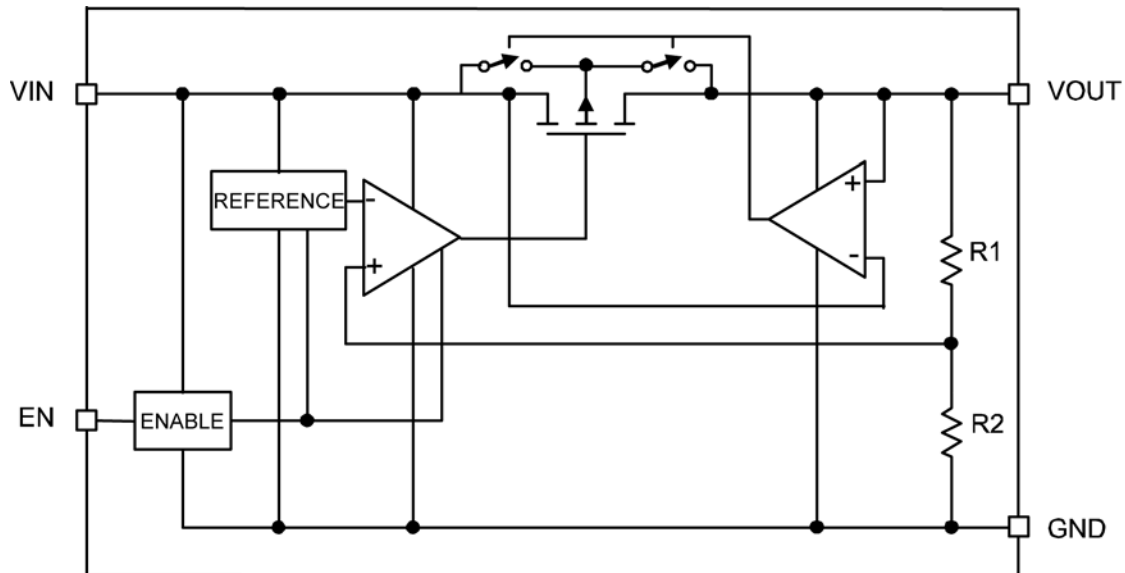

Absolute Maximum Ratings⁽¹⁾

Supply Input Voltage (V_{IN}).....	0V to 8V
Enable Input Voltage (V_{EN}).....	0V to 8V
Power Dissipation (P_D).....	Internally Limited ⁽³⁾
Junction Temperature (T_J).....	-40°C to +125°C
Storage Temperature (T_S).....	-65°C to +150°C
Lead Temperature (soldering, 5 sec.).....	260°C
ESD Rating ⁽⁴⁾	±2kV

Operating Ratings⁽²⁾

Supply voltage (V_{IN}).....	2.7V to 7V
Enable Input voltage (V_{EN}).....	0V to V_{IN}
Thermal Resistance	
TSOT-23-5 (θ_{JA}).....	235°C/W
MLF-6 (θ_{JA}).....	90°C/W

Electrical Characteristics⁽⁵⁾

$V_{IN} = V_{OUT} + 1.0V$, $C_{OUT} = 0.47\mu F$, $I_{OUT} = 100\mu A$, $T_J = 25^\circ C$, **bold** values indicate -40°C to +125°C, unless noted.

Parameter	Conditions	Min	Typ	Max	Units
Output Voltage Accuracy	Variation from nominal V_{OUT}	-2.0		+2.0	%
	Variation from nominal V_{OUT} ; -40C to +125C	-3.0		+3.0	%
Output Voltage Temp. Coefficient			40		ppm/C
Line Regulation	$V_{IN} = V_{OUT} + 1V$ to 7V;		0.02	0.25	%/V
Load Regulation	$I_{OUT} = 10\mu A$ to 10mA		0.2	1.0	%
				1.5	%
Dropout Voltage ⁽⁶⁾	$I_{OUT} = 100\mu A$ $I_{OUT} = 10mA$		60		mV
			100	300	mV
Ground Pin Current	$I_{OUT} = 10\mu A$		1.8	3	μA
Ground Pin Current in Shutdown	$V_{EN} \leq 0.18V$		0.1	1.5	μA
Current Limit	$V_{OUT} = 0V$		70	120	mA
Reverse Current ($V_{OUT} > V_{IN}$)	$V_{OUT} = V_{IN} + 1V$		0.02	1	μA
Ripple Rejection	$f = 10Hz$		55		dB
	$f = 1kHz$		35		dB
Output Voltage Noise	$C_{OUT} = 0.47\mu F$; 10Hz to 100kHz		400		μV_{rms}
Enable Input					
Enable Input Voltage	Logic Low (Regulator Shutdown)			0.18	V
	Logic High (Regulator Enabled)	1.4			V
Enable Input Current	$V_{IL} \leq 0.18V$ (Regulator Shutdown)		1		nA
	$V_{IH} \geq 1.4V$ (Regulator Enabled)		1		nA
Turn-on Time ⁽⁷⁾	$C_{OUT} = 0.47\mu F$		0.75	1.5	ms

Notes:

- Exceeding the absolute maximum rating may damage the device.
- The device is not guaranteed to function outside its operating rating.
- The maximum allowable power dissipation of any T_A (ambient temperature) is $P_{D(max)} = (T_{J(max)} - T_A) / \theta_{JA}$. Exceeding the maximum allowable power dissipation will result in excessive die temperature.
- Devices are ESD sensitive. Handling precautions recommended.
- Specification for packaged product only.
- Dropout voltage is defined as the input-to-output differential at which the output voltage drops 2% below its nominal V_{OUT} . For outputs below 2.7V, dropout voltage is the input-to-output differential with the minimum input voltage 2.7V.
- Turn-on time is measured from 10% of the positive edge of the enable signal to 90% of the rising edge of the output voltage of the regulator.

Typical Characteristics

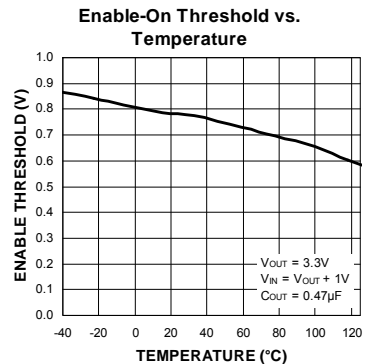
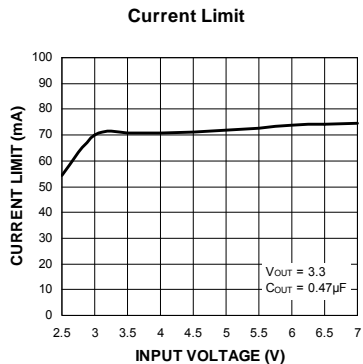
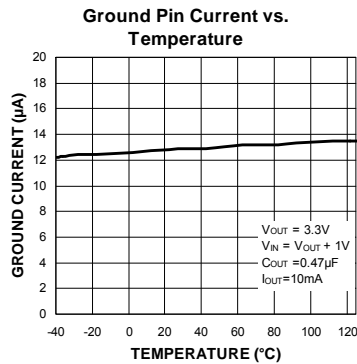
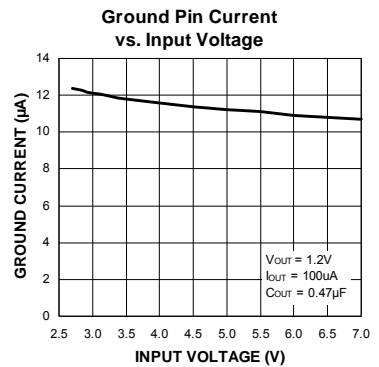
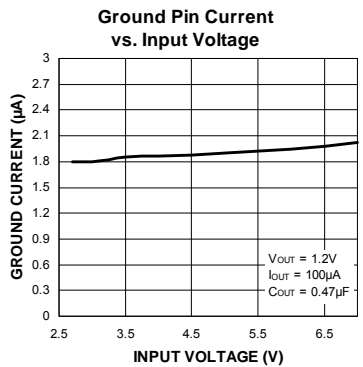
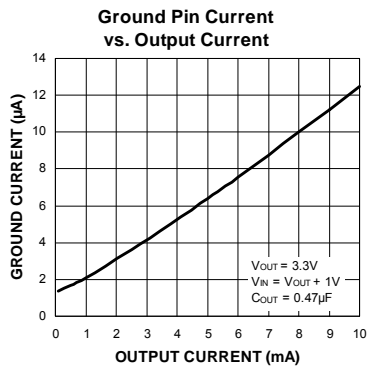
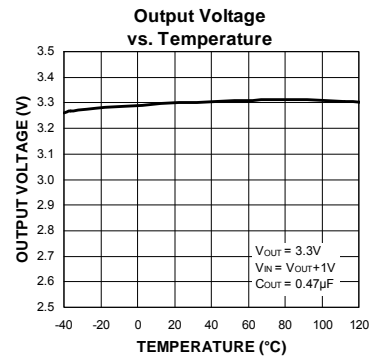
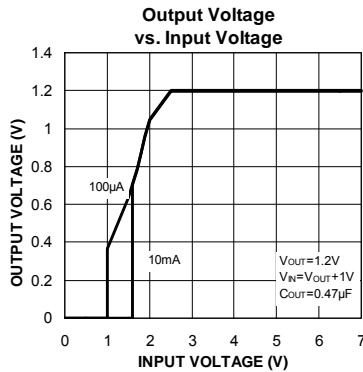
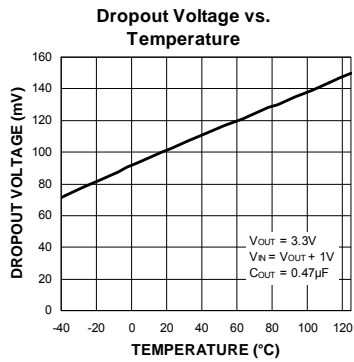
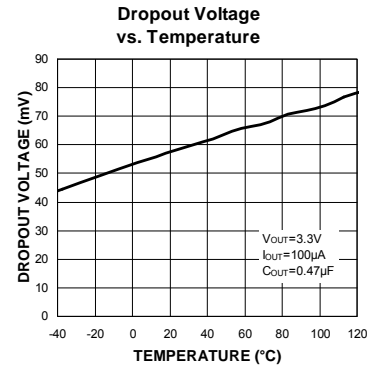
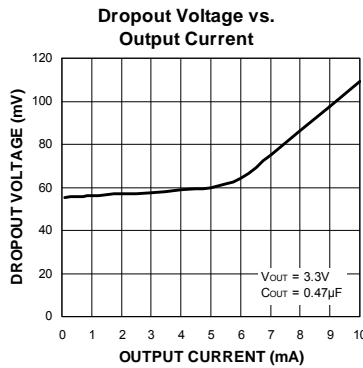
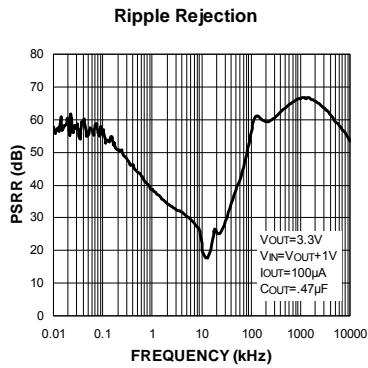

Typical Characteristics (continued)

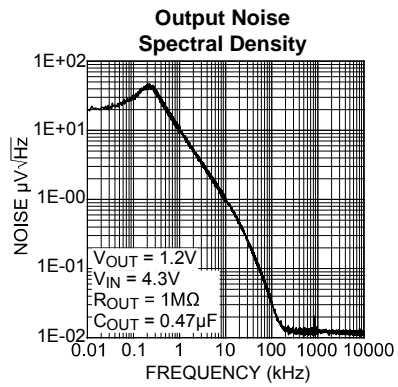
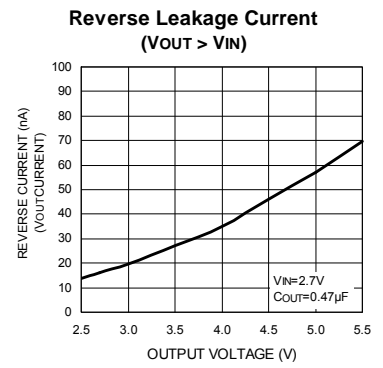
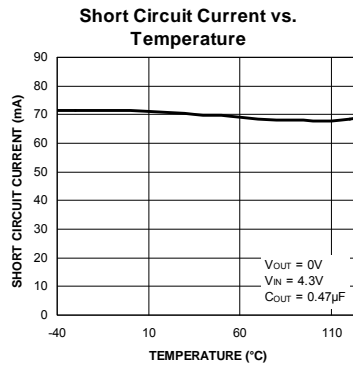
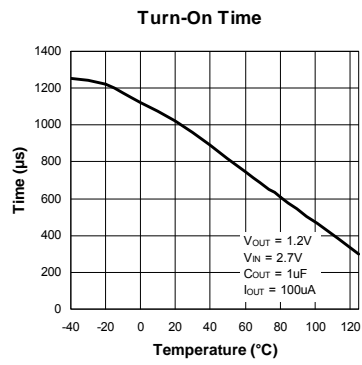

Functional Characteristics

Enable Turn-On Transient

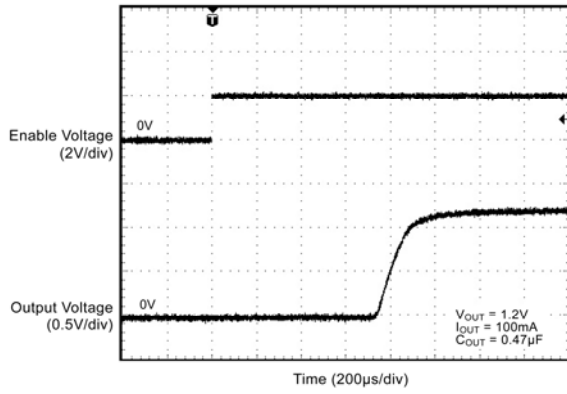

Load Transient Response

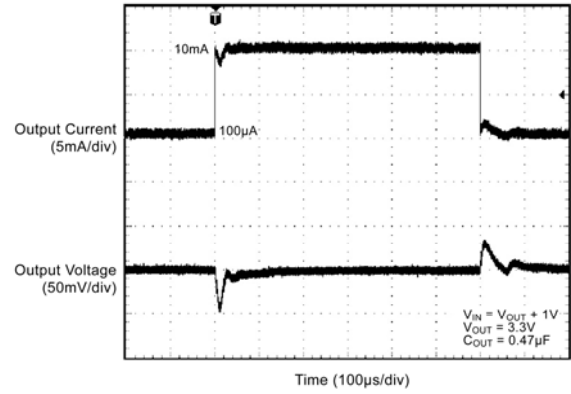

Line Transient Response

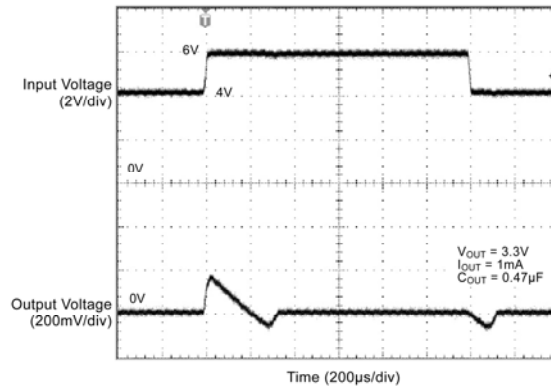

Application Information

Input Capacitor

If there is more than 20cm of wire between IN and the ac filter capacitor or if supplied from a battery, a 1 μ F (or larger) capacitor should be placed from the IN (supply input) to GND (ground).

Output Capacitors

The MIC5232 requires an output capacitor for stability. A 0.47 μ F, or larger capacitor, is recommended between VOUT (output) and GND to improve the regulator's transient response. A 0.47 μ F capacitor can be used to reduce overshoot recovery time at the expense of overshoot amplitude. The ESR (effective series resistance) of this capacitor has no effect on regulator stability, but low-ESR capacitors improve the high frequency transient response. The value of this capacitor may be increased without limit, but values larger than 10 μ F tend to increase the settling time after a step change in input voltage or output current.

Minimum Load Current

The MIC5232 does not require a minimum load for proper operation. This allows the device to operate in applications where very light output currents are required for keep-alive purposes. This is important for powering SRAM or Flash memory in low-power modes for handheld devices.

Safe Operating Conditions

The MIC5232 incorporates current limit in the design. There is also reverse circuit protection circuitry built into the device. The maximum junction temperature for the device is +125°C, and it is important that this is not exceeded for any length of time.

Thermal Considerations

The MIC5232 is designed to provide 10mA of continuous current in a very small package. Maximum ambient operating temperature can be calculated based on the output current and the voltage drop across the part. Given that the input voltage is 4.3V, the output voltage is 3.3V and the output current = 10mA.

The actual power dissipation of the regulator circuit can be determined using the equation:

$$P_D = (V_{IN} - V_{OUT}) I_{OUT} + V_{IN} I_{GND}$$

Because this device is CMOS and the ground current is typically <15 μ A over the load range, the power dissipation contributed by the ground current is < 1% and can be ignored for this calculation.

$$P_D = (4.3V - 3.3V) \cdot 10mA$$

$$P_D = 0.01W$$

To determine the maximum ambient operating temperature of the package, use the junction-to-ambient thermal resistance of the device and the following basic equation:

$$P_{D(max)} = \frac{T_{J(max)} - T_A}{\theta_{JA}}$$

$T_{J(max)} = 125^\circ\text{C}$, the max. junction temperature of the die, θ_{JA} thermal resistance = 90°C/W for the 2mm x 2mm MLF[®] package.

Substituting P_D for $P_{D(max)}$, and solving for the ambient operating temperature, will give the maximum operating conditions for the regulator circuit. The junction-to-ambient thermal resistance for the minimum footprint is 90°C/W. The maximum power dissipation must not be exceeded for proper operation.

For example, when operating the MIC5232-3.3BML at an input voltage of 4.3V and 10mA load with a minimum footprint layout, the maximum ambient operating temperature T_A can be determined as follows:

$$0.01W = \frac{125^\circ\text{C} - T_A}{90^\circ\text{C}/W}$$

$$T_A = 124^\circ\text{C}$$

Therefore, a 3.3V application at 10mA of output current can accept an ambient operating temperature of 124°C in a 2mm x 2mm MLF[®]-6 package. For a full discussion of heat sinking and thermal effects on voltage regulators, refer to the "Regulator Thermals" section of Micrel's "Designing with Low-Dropout Voltage Regulators" handbook. This information can be found on Micrel's website at:

http://www.micrel.com/_PDF/other/LDOBk_ds.pdf

Package Information

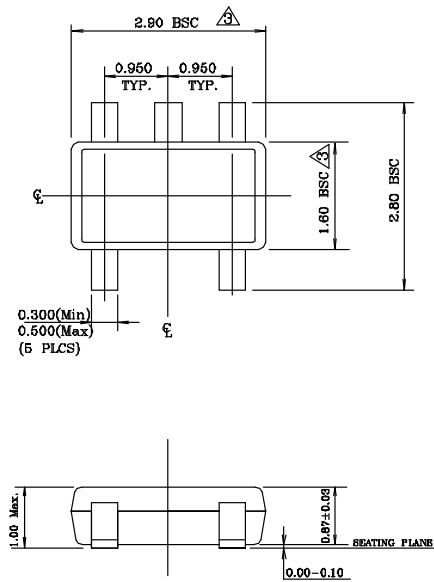

NOTE:

1. Dimensions and tolerances are as per ANSI Y14.5M, 1994.
2. Die is facing up for mold. Die is facing down for trim/form, ie. reverse trim/form.
3. Dimensions are exclusive of mold flash and gate burr.
4. The footlength measuring is based on the gauge plane method.
5. All specification comply to Jedec Spec MO193 Issue C.
6. All dimensions are in millimeters.

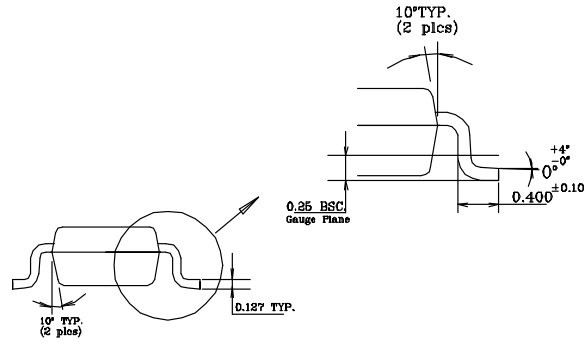

5-Pin TSOT-23 (D5)

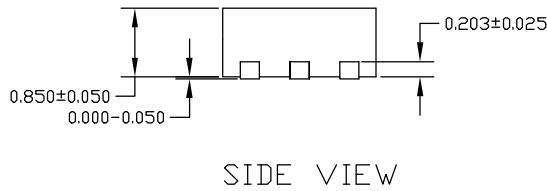
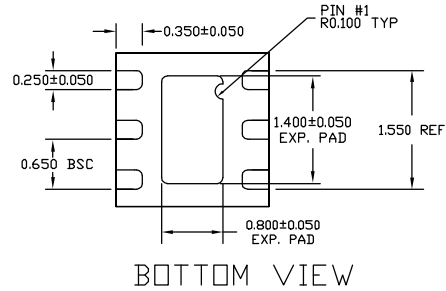
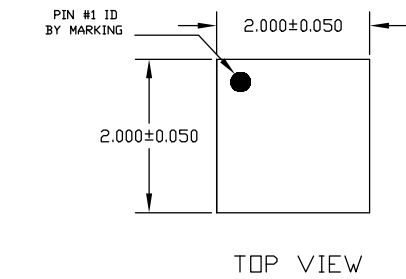

NOTE:

1. ALL DIMENSIONS ARE IN MILLIMETERS.
2. MAX. PACKAGE WARPAGE IS 0.05 mm.
3. MAXIMUM ALLOWABLE BURRS IS 0.076 mm IN ALL DIRECTIONS.
4. PIN #1 ID ON TOP WILL BE LASER MARKED.

6-Pin 2mm x 2mm MLF[®] (ML)

MICREL, INC. 2180 FORTUNE DRIVE SAN JOSE, CA 95131 USA
TEL +1 (408) 944-0800 FAX +1 (408) 474-1000 WEB <http://www.micrel.com>

The information furnished by Micrel in this data sheet is believed to be accurate and reliable. However, no responsibility is assumed by Micrel for its use. Micrel reserves the right to change circuitry and specifications at any time without notification to the customer.

Micrel Products are not designed or authorized for use as components in life support appliances, devices or systems where malfunction of a product can reasonably be expected to result in personal injury. Life support devices or systems are devices or systems that (a) are intended for surgical implant into the body or (b) support or sustain life, and whose failure to perform can be reasonably expected to result in a significant injury to the user. A Purchaser's use or sale of Micrel Products for use in life support appliances, devices or systems is a Purchaser's own risk and Purchaser agrees to fully indemnify Micrel for any damages resulting from such use or sale.

© 2005 Micrel, Inc.

X-ON Electronics

Largest Supplier of Electrical and Electronic Components

Click to view similar products for [LDO Voltage Regulators](#) category:

Click to view products by [Microchip](#) manufacturer:

Other Similar products are found below :

[M38D29FFHP#U1](#) [702103A](#) [717726C](#) [742457H](#) [MP20051DN-LF-Z](#) [R5F111PGGFB#30](#) [AP7363-SP-13](#) [NCP103AMX285TCG](#)
[NCV8664CST33T3G](#) [NCV8752AMX28TCG](#) [L9454](#) [AP7362-HA-7](#) [LX13043CLD](#) [TCR3DF185,LM\(CT](#) [TCR3DF24,LM\(CT](#)
[TCR3DF285,LM\(CT](#) [TCR3DF31,LM\(CT](#) [TCR3DF45,LM\(CT](#) [TLF4949EJ](#) [MP2013GQ-33-Z](#) [L9708](#) [L970813TR](#) [030014BB](#) [059985X](#)
[NCP121AMX173TCG](#) [NCP4687DH15T1G](#) [701326R](#) [702087BB](#) [755078E](#) [TCR2EN28,LF\(S](#) [LM1117DT-1.8/NO](#) [LT1086CM#TRPBF](#)
[AZ1085S2-1.5TRE1](#) [MAX15101EWL+T](#) [NCV8170AXV250T2G](#) [TCR3DF27,LM\(CT](#) [TCR3DF19,LM\(CT](#) [TCR3DF125,LM\(CT](#)
[TCR2EN18,LF\(S](#) [MAX15103EWL+T](#) [TS2937CZ-5.0 C0](#) [MAX8878EUK30-T](#) [MAX663CPA](#) [NCV4269CPD50R2G](#) [NCV8716MT30TBG](#)
[AZ1117IH-1.2TRG1](#) [MP2013GQ-P](#) [AP2112R5A-3.3TRG1](#) [AP7315-25W5-7](#) [MAX15102EWL+T](#)