

## 150 mA Low Noise $\mu$ Cap CMOS LDO

### Features

- Input Voltage Range: 2.7V to 6.0V
- Thin SOT Package: 1 mm Height SOT-23-5
- Ultra-Low Output Noise: 30  $\mu$ V<sub>RMS</sub>
- Stability with Ceramic Output Capacitors
- Ultra-Low Dropout: 135 mV @ 150 mA
- High output accuracy:
  - 1.0% Initial Accuracy
  - 2.0% Over Temperature
- Low Quiescent Current: 90  $\mu$ A
- Tight Load and Line Regulation
- TTL-Logic-Controlled Enable Input
- “Zero” Off-Mode Current
- Thermal Shutdown and Current-Limit Protection

### Applications

- Cellular Telephones and Pagers
- Cellular Accessories
- Battery-Powered Equipment
- Laptop, Notebook, and Palmtop Computers
- Consumer/Personal Electronics

### General Description

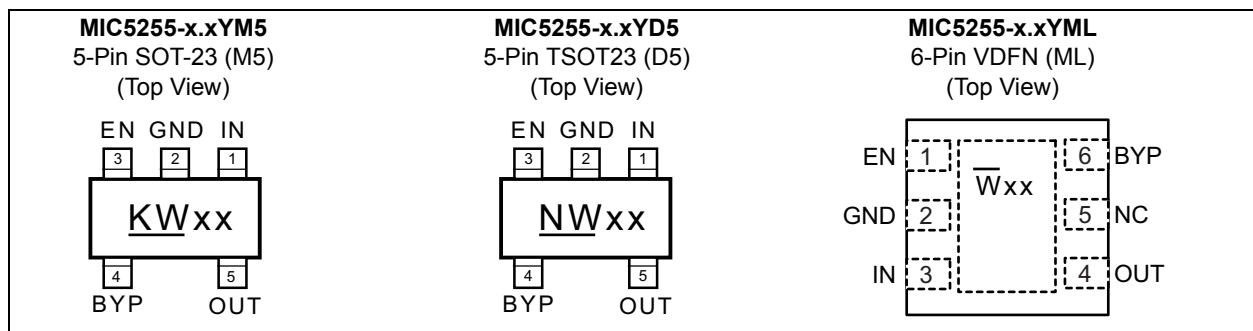
The MIC5255 is an efficient, precise CMOS voltage regulator optimized for ultra-low-noise applications. It offers 1% initial accuracy, extremely-low dropout voltage (135 mV at 150 mA) and low ground current (typically 117  $\mu$ A at full load). The MIC5255 provides a very low noise output, ideal for RF applications where a clean voltage source is required. A noise bypass pin is also available for further reduction of output noise.

Designed specifically for handheld and battery powered devices, the MIC5255 provides a TTL-logic-compatible enable pin. When disabled, power consumption drops nearly to zero.

The MIC5255 also works with low-ESR ceramic capacitors, reducing the amount of board space necessary for power applications, critical in handheld wireless devices.

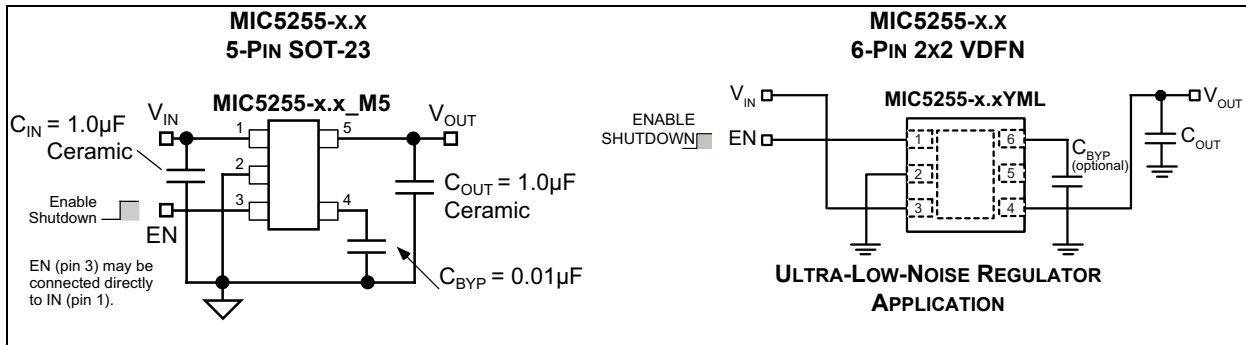
Key features include current limit, thermal shutdown, faster transient response, and an active clamp to speed up device turn-off. Available in the 6-pin 2 mm  $\times$  2 mm VDFN package, the SOT-23-5 package and the Thin SOT-23-5, which offers the same footprint as the standard SOT-23-5, but is only 1 mm tall. The MIC5255 offers a range of output voltages.

### Package Types

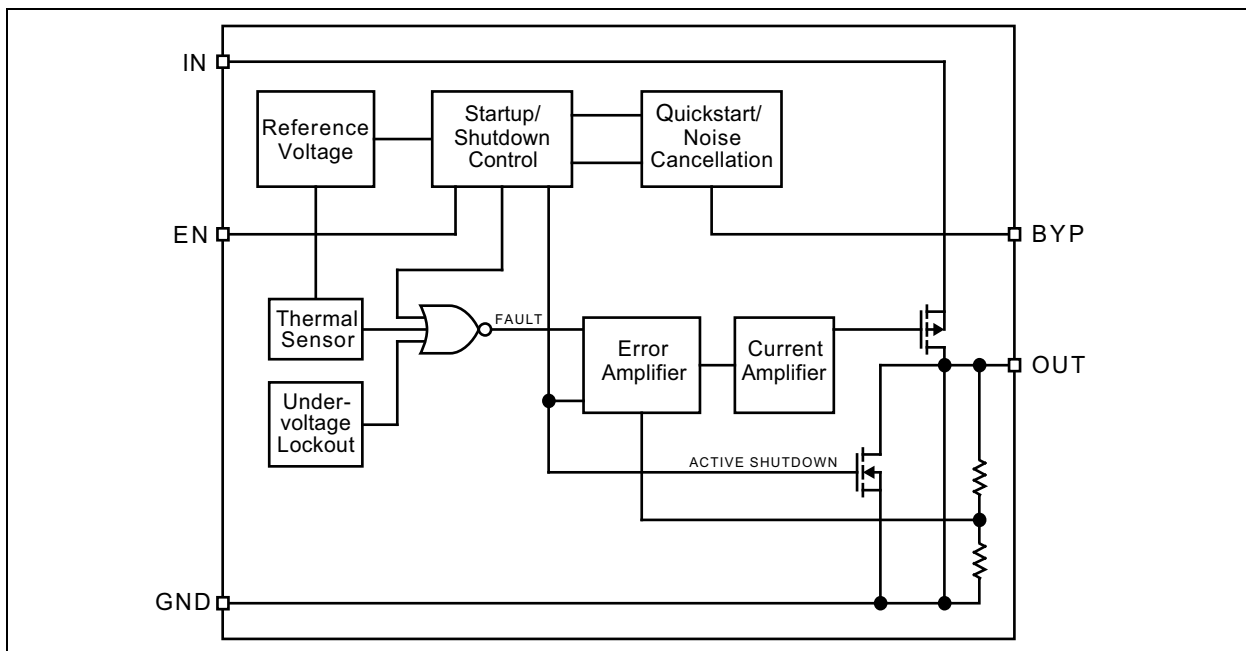


# MIC5255

## Typical Application Schematic



## Block Diagram



## 1.0 ELECTRICAL CHARACTERISTICS

### Absolute Maximum Ratings †

Supply Voltage ( $V_{IN}$ ) .....	0V to +7V
Enable Voltage ( $V_{EN}$ ) .....	0V to +7V
Power Dissipation ( $P_D$ , <a href="#">Note 1</a> ) .....	Internally Limited
ESD Rating ( <a href="#">Note 2</a> ) .....	2 kV

### Operating Ratings ‡

Supply Voltage ( $V_{IN}$ ) .....	+2.7V to +6V
Enable Voltage ( $V_{EN}$ ) .....	0V to $V_{IN}$

† **Notice:** Stresses above those listed under “Absolute Maximum Ratings” may cause permanent damage to the device. This is a stress rating only and functional operation of the device at those or any other conditions above those indicated in the operational sections of this specification is not intended. Exposure to maximum rating conditions for extended periods may affect device reliability.

‡ **Notice:** The device is not guaranteed to function outside its operating ratings.

**Note 1:** The maximum allowable power dissipation of any  $T_A$  (ambient temperature) is  $P_{D(max)} = (T_{J(max)} - T_A) / \theta_{JA}$ . Exceeding the maximum allowable power dissipation will result in excessive die temperature, and the regulator will go into thermal shutdown. The  $\theta_{JA}$  of the MIC5255-x.xYM5 (all versions) is 235°C/W on a PC board. See the [Thermal Considerations](#) section for further details.

**2:** Devices are ESD sensitive. Handling precautions recommended. Human body model, 1.5 kΩ in series with 100 pF.

# MIC5255

**TABLE 1-1: ELECTRICAL CHARACTERISTICS**

<b>Electrical Characteristics:</b> $V_{IN} = V_{OUT} + 1V$ , $V_{EN} = V_{IN}$ ; $I_{OUT} = 100 \mu A$ ; $T_J = 25^\circ C$ , <b>bold</b> values indicate $-40^\circ C \leq T_J \leq +125^\circ C$ ; unless noted. ( <b>Note 1</b> ).						
Parameters	Sym.	Min.	Typ.	Max.	Units	Conditions
Output Voltage Accuracy	$V_O$	-1	—	1	%	$I_{OUT} = 100 \mu A$
		<b>-2</b>	—	<b>2</b>		
Line Regulation	$\Delta V_{LNR}$	—	0.02	0.05	%/V	$V_{IN} = V_{OUT} + 1V$ to 6V
Load Regulation	$\Delta V_{LDR}$	—	1.5	2.5	%	$I_{OUT} = 0.1$ mA to 150 mA; <b>Note 2</b>
Dropout Voltage, <b>Note 3</b>	$V_{IN} - V_{OUT}$	—	0.1	5	mV	$I_{OUT} = 100 \mu A$
		—	90	150		$I_{OUT} = 100$ mA
		—	135	200		$I_{OUT} = 150$ mA
		—	—	<b>250</b>		
Quiescent Current	$I_Q$	—	0.2	<b>5</b>	$\mu A$	$V_{EN} \leq 0.4V$ (shutdown)
Ground Pin Current, <b>Note 4</b>	$I_{GND}$	—	90	150	$\mu A$	$I_{OUT} = 0$ mA
		—	117	—		$I_{OUT} = 150$ mA
Ripple Rejection	PSRR	—	60	—	dB	$f = 10$ Hz, $C_{OUT} = 1.0 \mu F$ , $C_{BYP} = 0.01 \mu F$
		—	60	—		$f = 100$ Hz, $V_{IN} = V_{OUT} + 1V$
		—	50	—		$f = 10$ kHz, $V_{IN} = V_{OUT} + 1V$
Current Limit	$I_{LIM}$	160	425	—	$mA$	$V_{OUT} = 0V$
Output Voltage Noise	$e_n$	—	30	—	$\mu V_{RMS}$	$C_{OUT} = 1.0 \mu F$ , $C_{BYP} = 0.01 \mu F$ , $f = 10$ Hz to 100 kHz
<b>Enable Input</b>						
Enable Input Logic-Low Voltage	$V_{IL}$	—	—	<b>0.4</b>	V	$V_{IN} = 2.7V$ to 5.5V, regulator shutdown
Enable Input Logic-High Voltage	$V_{IH}$	<b>1.6</b>	—	—	V	$V_{IN} = 2.7V$ to 5.5V, regulator enabled
Enable Input Current	$I_{EN}$	—	0.01	—	$\mu A$	$V_{IL} \leq 0.4V$ , regulator shutdown
		—	0.01	—	$\mu A$	$V_{IH} \geq 1.6V$ , regulator enabled
Shutdown Resistance Discharge	—	—	500	—	$\Omega$	—
<b>Thermal Protection</b>						
Thermal Shutdown Temperature	—	—	150	—	$^\circ C$	—
Thermal Shutdown Hysteresis	—	—	10	—	$^\circ C$	—

**Note 1:** Specification for packaged product only.

**2:** Regulation is measured at constant junction temperature using low duty cycle pulse testing. Parts are tested for load regulation in the load range from 1.0 mA to 150 mA. Changes in output voltage due to heating effects are covered by the thermal regulation specification.

**3:** Dropout voltage is defined as the input to output differential at which the output voltage drops 2% below its nominal value measured at 1V differential. For outputs below 2.7V, dropout voltage is the input-to-output voltage differential with the minimum input voltage 2.7V. Minimum input operating voltage is 2.7V.

**4:** Ground pin current is the regulator quiescent current. The total current drawn from the supply is the sum of the load current plus the ground pin current.

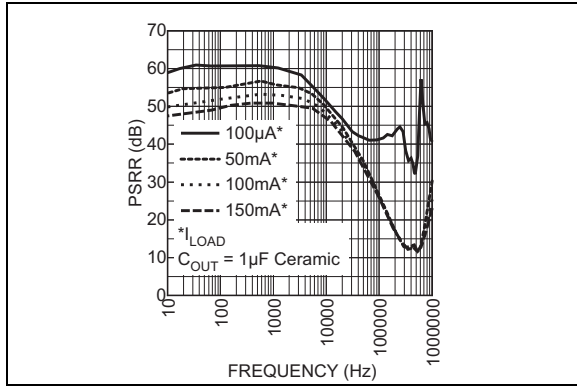
## TEMPERATURE SPECIFICATIONS

Parameters	Sym.	Min.	Typ.	Max.	Units	Conditions
<b>Temperature Ranges</b>						
Junction Operating Temperature Range	$T_J$	-40	—	+125	°C	Note 1
Storage Temperature	$T_S$	-60	—	+150	°C	—
Lead Temperature	—	—	—	+260	°C	Soldering, 5s
<b>Package Thermal Resistances</b>						
Thermal Resistance, SOT-23-5	$\theta_{JA}$	—	235	—	°C/W	—
Thermal Resistance, 2x2 VDFN-6	$\theta_{JA}$	—	90	—	°C/W	—

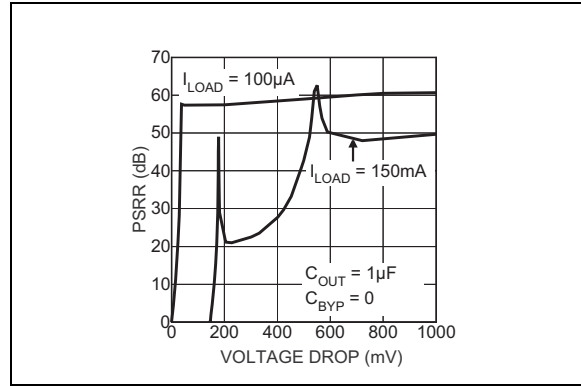
**Note 1:** The maximum allowable power dissipation is a function of ambient temperature, the maximum allowable junction temperature and the thermal resistance from junction to air (i.e.,  $T_A$ ,  $T_J$ ,  $\theta_{JA}$ ). Exceeding the maximum allowable power dissipation will cause the device operating junction temperature to exceed the maximum +125°C rating. Sustained junction temperatures above +125°C can impact the device reliability.

## 2.0 TYPICAL PERFORMANCE CURVES

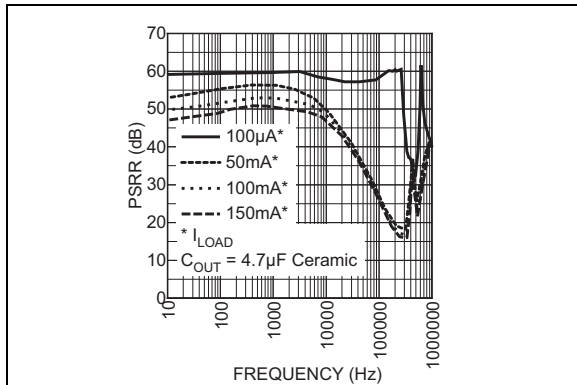
**Note:** The graphs and tables provided following this note are a statistical summary based on a limited number of samples and are provided for informational purposes only. The performance characteristics listed herein are not tested or guaranteed. In some graphs or tables, the data presented may be outside the specified operating range (e.g., outside specified power supply range) and therefore outside the warranted range.



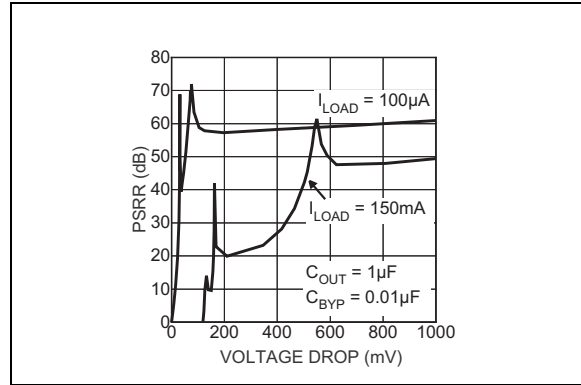
**FIGURE 2-1:** Power Supply Rejection Ratio.



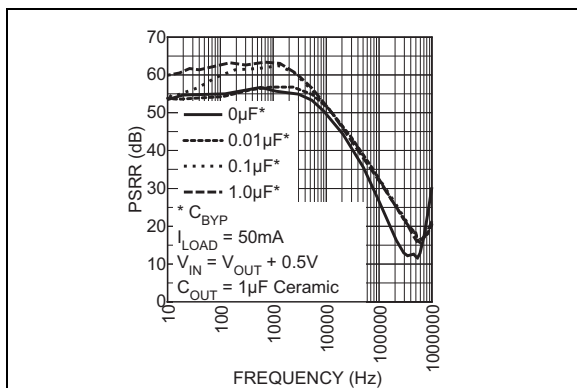
**FIGURE 2-4:** PSRR vs. Voltage Drop.



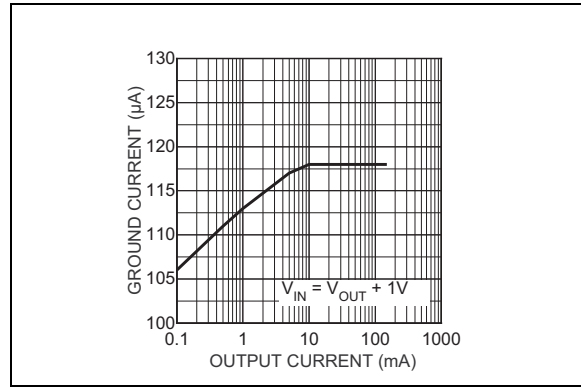
**FIGURE 2-2:** Power Supply Rejection Ratio.



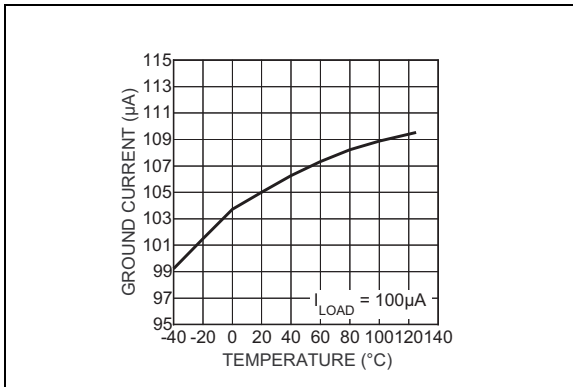
**FIGURE 2-5:** PSRR vs. Voltage Drop.



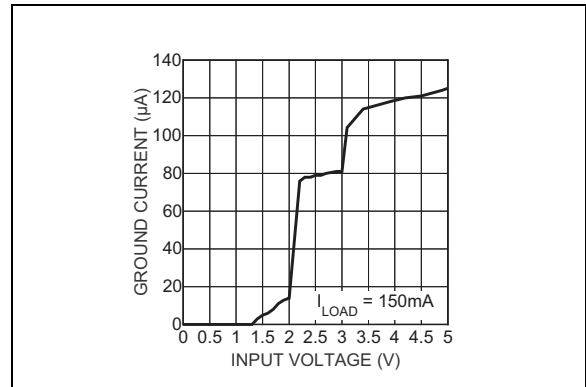
**FIGURE 2-3:** Power Supply Rejection Ratio.



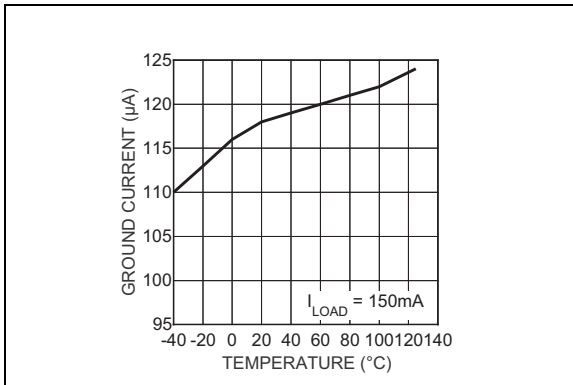
**FIGURE 2-6:** Ground Pin Current.



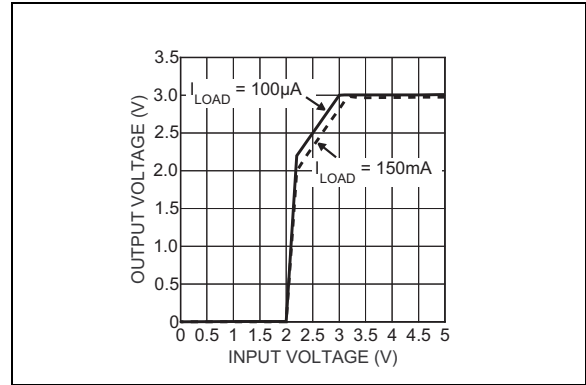
**FIGURE 2-7:** Ground Pin Current.



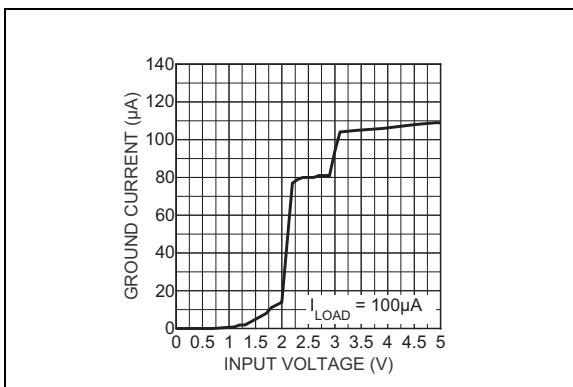
**FIGURE 2-10:** Ground Pin Current.



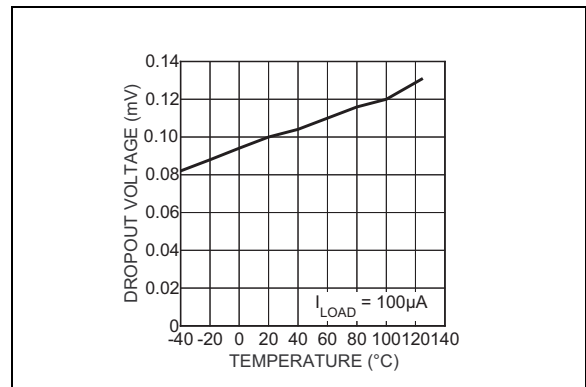
**FIGURE 2-8:** Ground Pin Current.



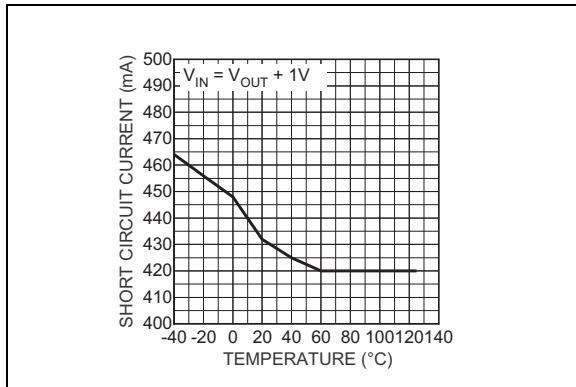
**FIGURE 2-11:** Dropout Characteristics.



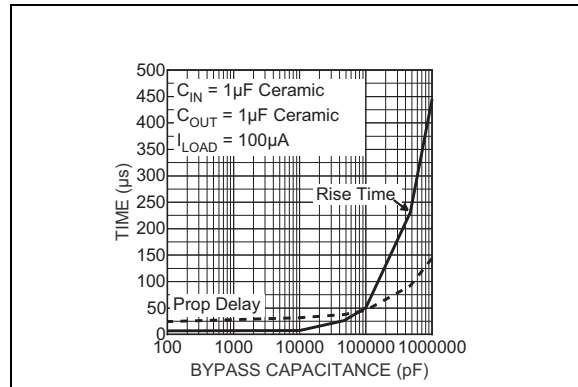
**FIGURE 2-9:** Ground Pin Current.



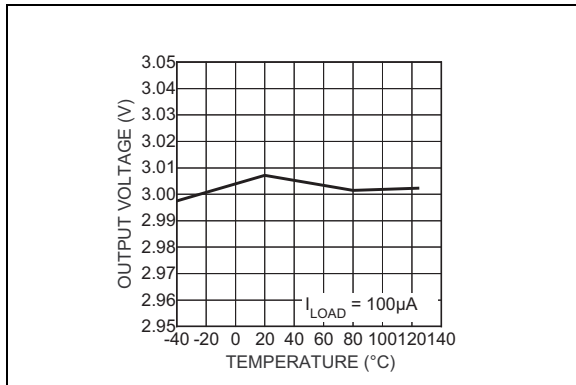
**FIGURE 2-12:** Dropout Voltage.



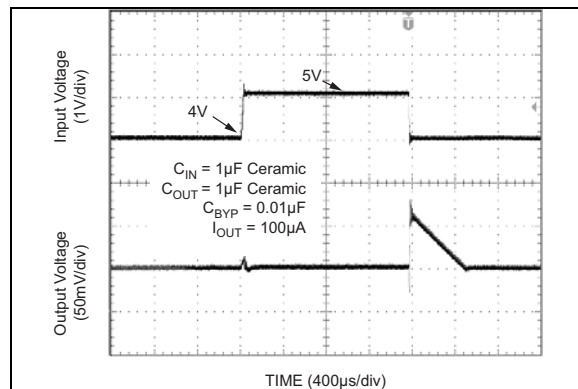
**FIGURE 2-13:** Short Circuit Current.



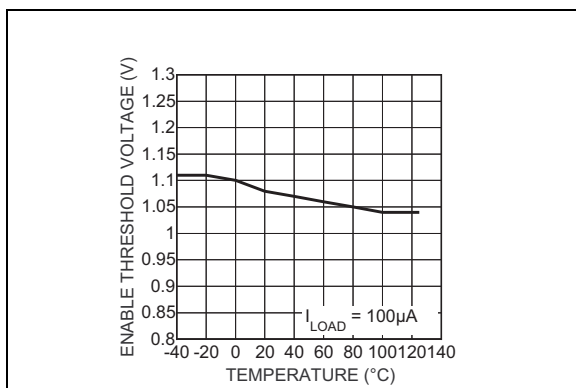
**FIGURE 2-16:** Turn-On Time vs. Bypass Capacitance.



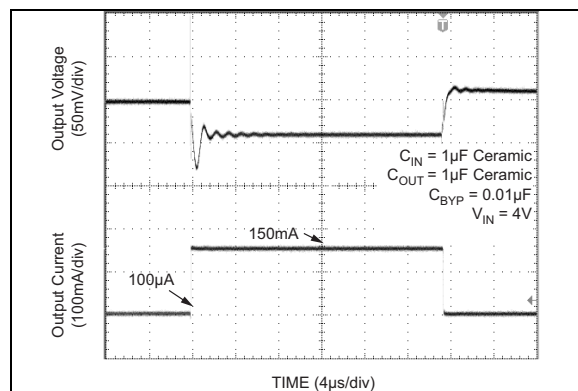
**FIGURE 2-14:** Output Voltage vs. Temperature.



**FIGURE 2-17:** Line Transient Response.

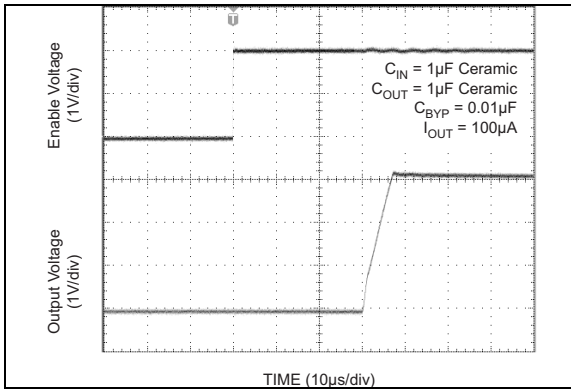


**FIGURE 2-15:** Enable Threshold vs. Temperature.

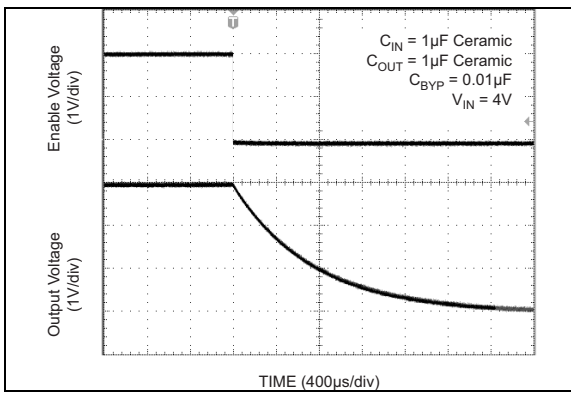


**FIGURE 2-18:** Load Transient Response.





**FIGURE 2-19:** Enable Pin Delay.



**FIGURE 2-20:** Shutdown Delay.

# MIC5255

---

## 3.0 PIN DESCRIPTIONS

The descriptions of the pins are listed in [Table 3-1](#).

**TABLE 3-1: PIN FUNCTION TABLE**

Pin Number SOT23-5 TSOT23-5	Pin Number VDFN-6	Pin Name	Description
1	3	IN	Supply Input.
2	2	GND	Ground.
3	1	EN	Enable/Shutdown (Input): CMOS-compatible input. Logic-high = enable; logic-low = shutdown. Do not leave open.
4	6	BYP	Reference Bypass: Connect external $0.01 \mu\text{F} \leq C_{\text{BYP}} \leq 1.0 \mu\text{F}$ capacitor to GND to reduce output noise. May be left open.
5	4	OUT	Regulator Output.
—	5	NC	No internal connection.
—	EP	GND	Ground: Internally connected to the exposed pad. Connect externally to GND pin.

## 4.0 APPLICATION INFORMATION

### 4.1 Enable Shutdown

The MIC5255 comes with an active-high enable pin that allows the regulator to be disabled. Forcing the enable pin low disables the regulator and sends it into a “zero” off-mode current state. In this state, current consumed by the regulator goes nearly to zero. Forcing the enable pin high enables the output voltage. This part is CMOS and the enable pin cannot be left floating; a floating enable pin may cause an indeterminate state on the output.

### 4.2 Input Capacitor

The MIC5255 is a high performance, high bandwidth device. Therefore, it requires a well-bypassed input supply for optimal performance. A 1 μF capacitor is required from the input to ground to provide stability. Low-ESR ceramic capacitors provide optimal performance at a minimum of space. Additional high frequency capacitors, such as small valued NPO dielectric type capacitors, help filter out high frequency noise and are good practice in any RF-based circuit.

### 4.3 Output Capacitor

The MIC5255 requires an output capacitor for stability. The design requires 1 μF or greater on the output to maintain stability. The design is optimized for use with low-ESR ceramic chip capacitors. High ESR capacitors may cause high frequency oscillation. The maximum recommended ESR is 300 mΩ. The output capacitor can be increased, but performance has been optimized for a 1 μF ceramic output capacitor and does not improve significantly with larger capacitance.

X7R/X5R dielectric-type ceramic capacitors are recommended because of their temperature performance. X7R-type capacitors change capacitance by 15% over their operating temperature range and are the most stable type of ceramic capacitors. Z5U and Y5V dielectric capacitors change value by as much as 50% and 60%, respectively, over their operating temperature ranges. To use a ceramic chip capacitor with Y5V dielectric, the value must be much higher than an X7R ceramic capacitor to ensure the same minimum capacitance over the equivalent operating temperature range.

### 4.4 Bypass Capacitor

A capacitor can be placed from the noise bypass pin to ground to reduce output voltage noise. The capacitor bypasses the internal reference. A 0.01 μF capacitor is recommended for applications that require low-noise outputs. The bypass capacitor can be increased, further reducing noise and improving PSRR. Turn-on time increases slightly with respect to bypass capacitance. A unique quick-start circuit allows the

MIC5255 to drive a large capacitor on the bypass pin without significantly slowing turn-on time. Refer to the [Typical Performance Curves](#) section for performance with different bypass capacitors.

### 4.5 Active Shutdown

The MIC5255 also features an active shutdown clamp, which is an N-Channel MOSFET that turns on when the device is disabled. This allows the output capacitor and load to discharge, de-energizing the load.

### 4.6 No-Load Stability

The MIC5255 will remain stable and in regulation with no load unlike many other voltage regulators. This is especially important in CMOS RAM keep-alive applications.

### 4.7 Thermal Considerations

The MIC5255 is designed to provide 150 mA of continuous current in a very small package. Maximum power dissipation can be calculated based on the output current and the voltage drop across the part. To determine the maximum power dissipation of the package, use the junction-to-ambient thermal resistance of the device and the following basic equation:

**EQUATION 4-1:**

$$P_{D(MAX)} = \left( \frac{T_{J(MAX)} - T_A}{\theta_{JA}} \right)$$

$T_{J(MAX)}$  is the maximum junction temperature of the die, 125°C, and  $T_A$  is the ambient operating temperature.  $\theta_{JA}$  is layout dependent; [Table 4-1](#) shows examples of junction-to-ambient thermal resistance for the MIC5255.

**TABLE 4-1: SOT23-5 THERMAL RESISTANCE**

Package	$\theta_{JA}$ Recommended Minimum Footprint	$\theta_{JA}$ 1” Square Copper Clad	$\theta_{JC}$
SOT23-5 (M5 or D5)	235°C/W	185°C/W	145°C/W

The actual power dissipation of the regulator circuit can be determined using the equation:

# MIC5255

---

## EQUATION 4-2:

$$P_D = (V_{IN} - V_{OUT})I_{OUT} + V_{IN} \times I_{GND}$$

Substituting  $P_{D(MAX)}$  for  $P_D$  and solving for the operating conditions that are critical to the application will give the maximum operating conditions for the regulator circuit. For example, when operating the MIC5255-3.0YM5 at +50°C with a minimum footprint layout, the maximum input voltage for a set output current can be determined as follows:

## EQUATION 4-3:

$$P_{D(MAX)} = \left( \frac{125^\circ C - 50^\circ C}{235^\circ C/W} \right) = 319mW$$

The junction-to-ambient thermal resistance for the minimum footprint is 235°C/W, from [Table 4-1](#). The maximum power dissipation must not be exceeded for proper operation. Using the output voltage of 3.0V and an output current of 150 mA, the maximum input voltage can be determined for the series of equations between [Equation 4-4](#) and [Equation 4-7](#). Because this device is CMOS and the ground current is typically 100 µA over the load range, the power dissipation contributed by the ground current is <1% and can be ignored for this calculation:

## EQUATION 4-4:

$$319mW = (V_{IN} - 3.0V) \times 150mA$$

## EQUATION 4-5:

$$319mW = V_{IN} \times 150mA - 450mW$$

## EQUATION 4-6:

$$769mW = V_{IN} \times 150mA$$

## EQUATION 4-7:

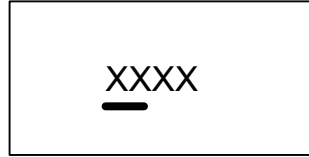
$$V_{IN(MAX)} = 5.12V$$

Therefore, a 3.0V application at 150 mA of output current can accept a maximum input voltage of 5.12V in a SOT23-5 package.

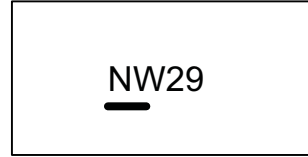
## 5.0 PACKAGING INFORMATION

### 5.1 Package Marking Information

5-Pin TSOT-23\*



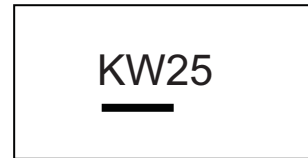
Example



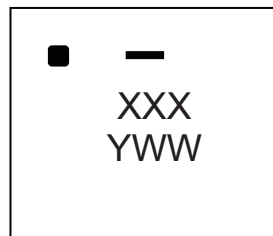
5-Pin SOT-23\*



Example



6-Pin VDFN\*



Example



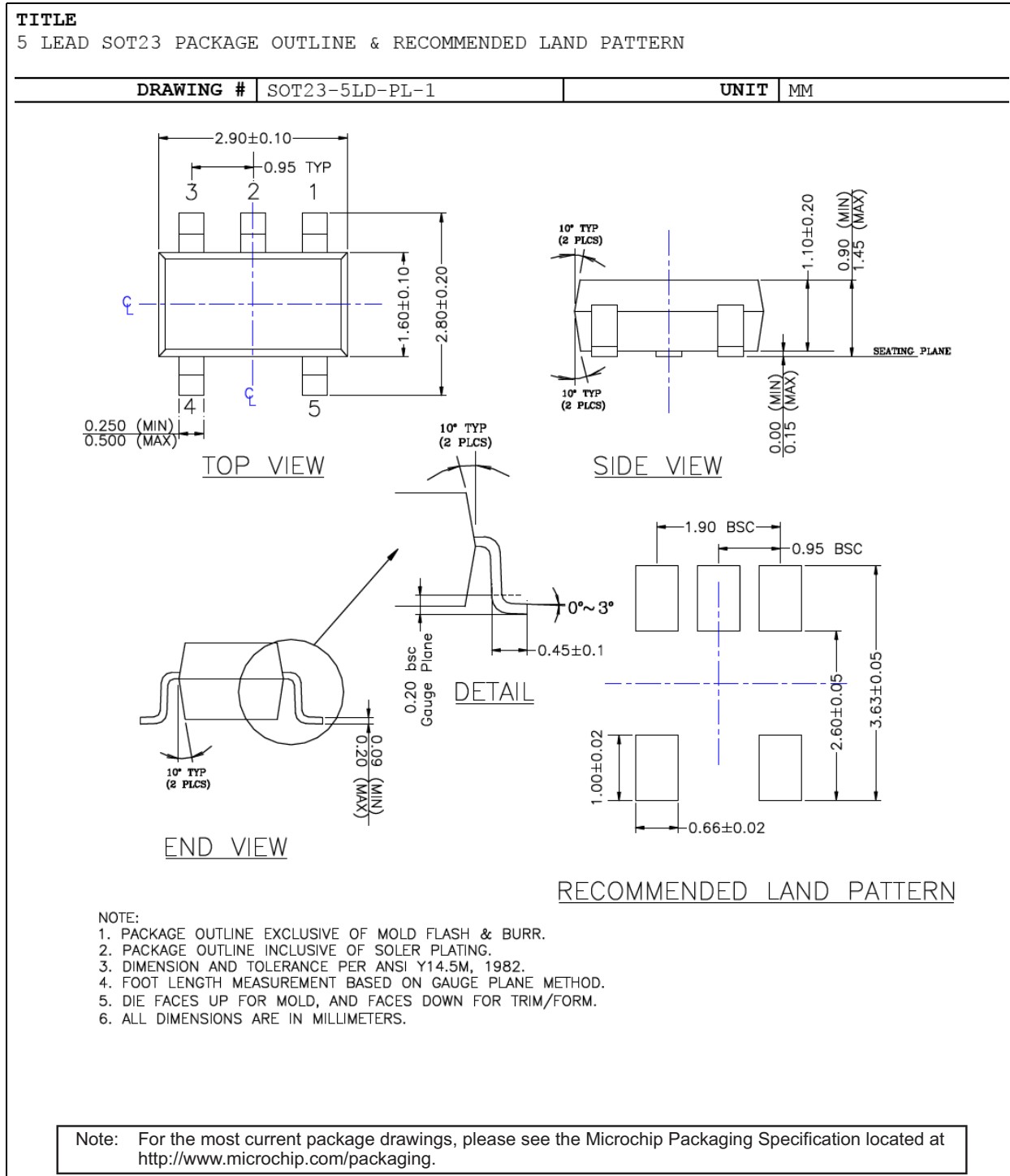
<b>Legend:</b>	XX...X	Product code or customer-specific information
	Y	Year code (last digit of calendar year)
	YY	Year code (last 2 digits of calendar year)
	WW	Week code (week of January 1 is week '01')
	NNN	Alphanumeric traceability code
	(e3)	Pb-free JEDEC® designator for Matte Tin (Sn)
	*	This package is Pb-free. The Pb-free JEDEC designator ((e3)) can be found on the outer packaging for this package.
	•, ▲, ▼	Pin one index is identified by a dot, delta up, or delta down (triangle mark).

**Note:** In the event the full Microchip part number cannot be marked on one line, it will be carried over to the next line, thus limiting the number of available characters for customer-specific information. Package may or may not include the corporate logo.

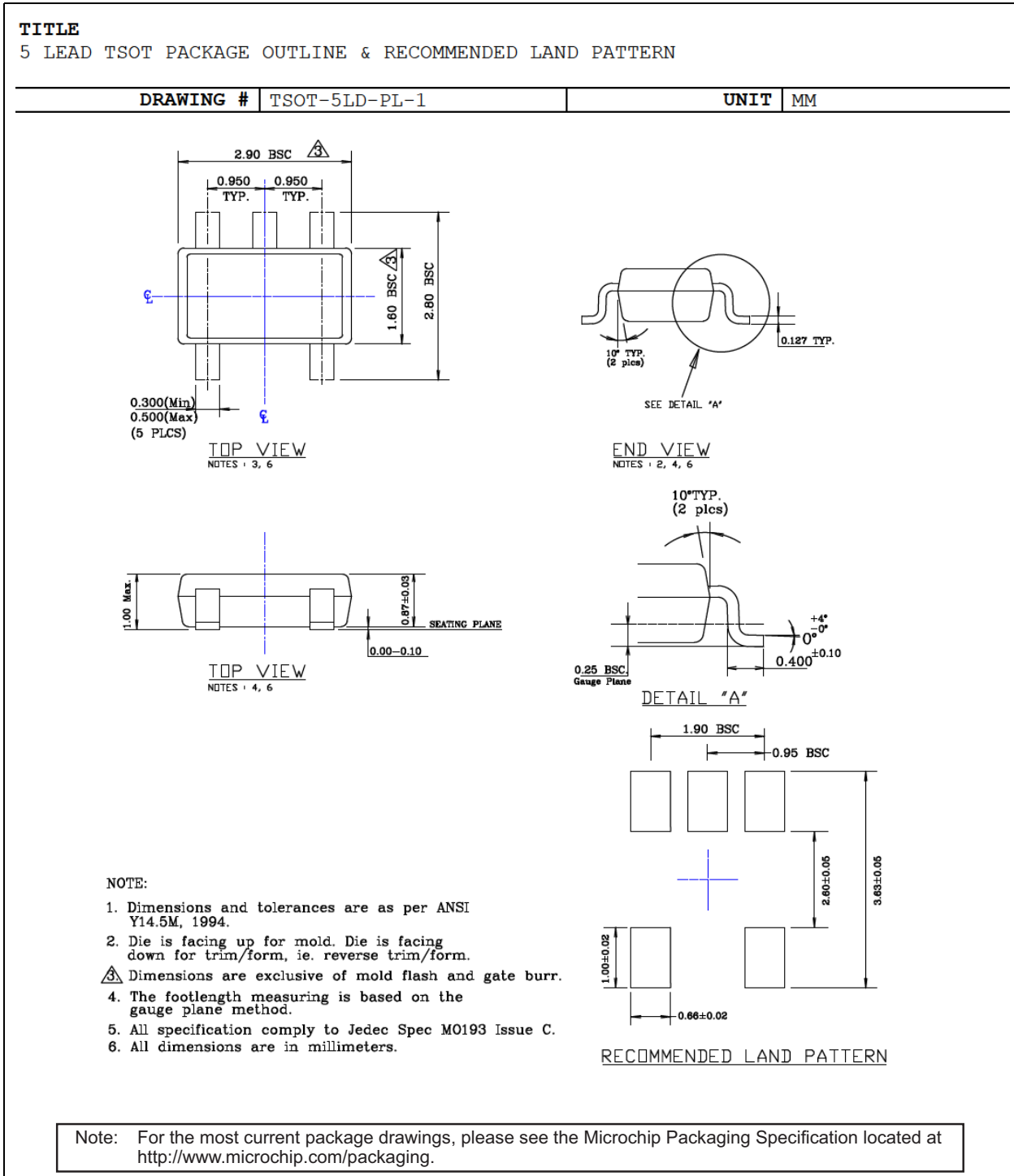
Underbar ( \_ ) and/or Overbar ( ¯ ) symbol may not be to scale.

# MIC5255

## 5-Pin SOT-23 Package Outline and Recommended Land Pattern

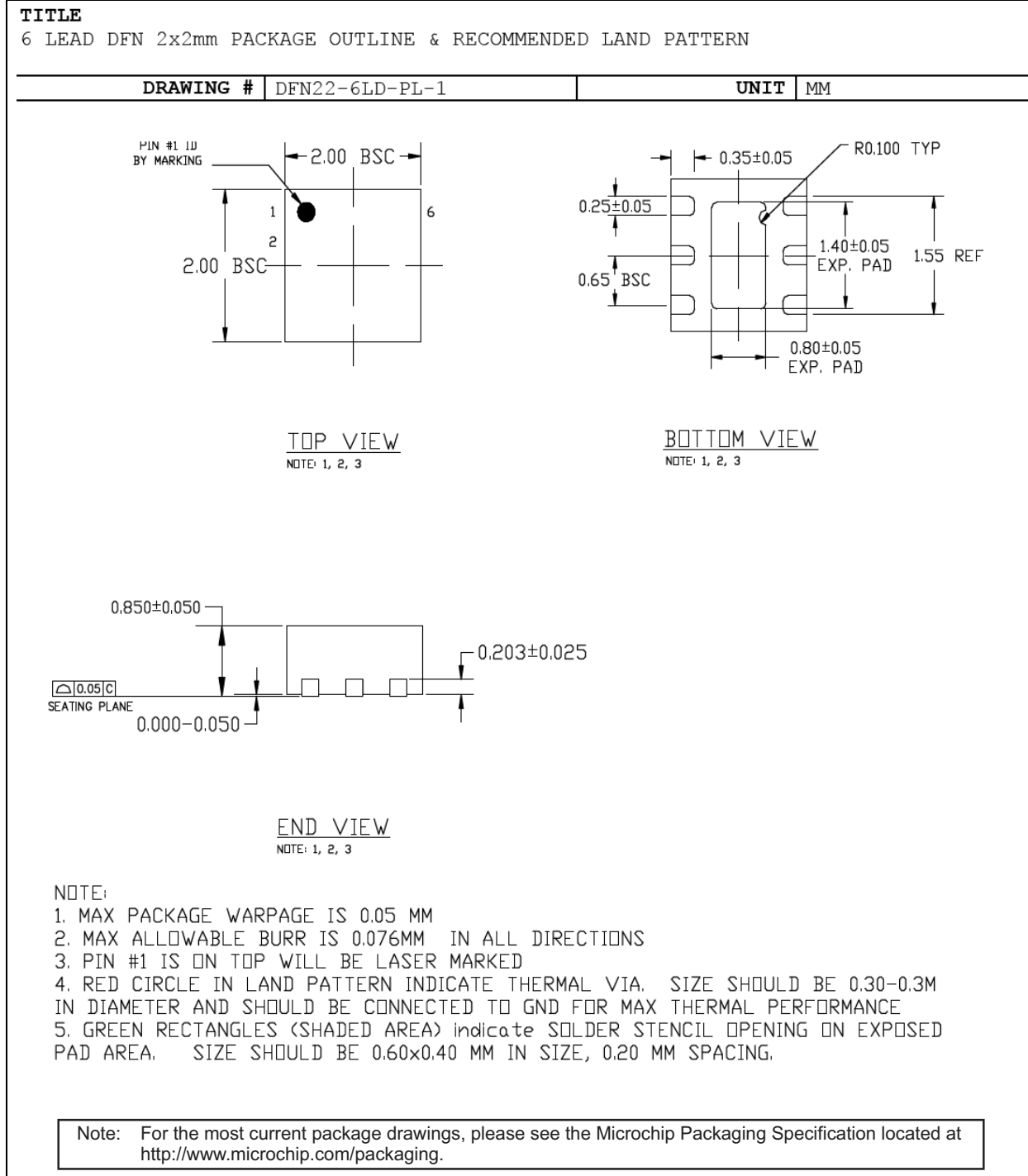


## 5-Pin TSOT-23 Package Outline and Recommended Land Pattern



# MIC5255

## 6-Pin 2 mm x 2 mm VDFN Package Outline and Recommended Land Pattern





## APPENDIX A: REVISION HISTORY

### Revision A (November 2016)

- Converted Micrel document MIC5255 to Microchip data sheet DS20005661A.
- Minor text changes throughout.
- Leaded parts (B-designated) removed from data sheet.
- Voltage options updated in the [Product Identification System](#) section.
- DFN package naming updated to Microchip-standard VDFN package.
- Typical ground current updated on Page 1.
- Equation values on Page 12 updated.

# MIC5255

---

NOTES:

## PRODUCT IDENTIFICATION SYSTEM

To order or obtain information, e.g., on pricing or delivery, contact your local Microchip representative or sales office.

PART NO.	-	XX	X	XX	-	XX
Device		Voltage	Temperature	Package		Media Type
<b>Device:</b>	MIC5255:	150 mA Low Noise $\mu$ Cap CMOS LDO				
<b>Voltage:</b> (Note 1, Note 2, Note 3)		2.5 = 2.5V				
		2.8 = 2.8V				
		3.0 = 3.0V				
		3.2 = 3.2V				
		3.3 = 3.3V				
<b>Temperature:</b>	Y =	-40°C to +125°C				
<b>Package:</b>	M5 =	5-Pin SOT-23				
	D5 =	5-Pin TSOT-23				
	ML =	6-Pin 2 mm x 2 mm VDFN				
<b>Media Type:</b> (Note 4)	TR =	3,000/Reel (5,000/Reel if ML package option)				
	TX =	3,000/Reel with Reverse Pin 1 Orientation				
<b>Note 1:</b>	Other voltage options available. Contact Microchip for details.					
<b>Note 2:</b>	The 5-Pin TSOT package (D5) is not available in the 3.2V option.					
<b>Note 3:</b>	The 6-Pin VDFN package (ML) is not available in 2.5V and 3.2V options.					
<b>Note 4:</b>	The TX media type is not available with the ML package option.					
<b>Examples:</b>						
a)	MIC5255-2.5YM5-TR:	150 mA Low Noise $\mu$ Cap CMOS LDO, 2.5V Output Voltage, -40°C to +125°C Temp. Range, 5-Pin SOT-23, 3,000/Reel				
b)	MIC5255-2.5YD5-TX:	150 mA Low Noise $\mu$ Cap CMOS LDO, 2.5V Output Voltage, -40°C to +125°C Temp. Range, 5-Pin TSOT-23, 3,000/Reel with Reverse Pin 1 Orientation				
c)	MIC5255-2.8YML-TR:	150 mA Low Noise $\mu$ Cap CMOS LDO, 2.8V Output Voltage, -40°C to +125°C Temp. Range, 6-Pin VDFN, 5,000/Reel				
d)	MIC5255-3.0YD5-TX:	150 mA Low Noise $\mu$ Cap CMOS LDO, 3.0V Output Voltage, -40°C to +125°C Temp. Range, 5-Pin TSOT-23, 3,000/Reel with Reverse Pin 1 Orientation				
e)	MIC5255-3.2YM5-TR:	150 mA Low Noise $\mu$ Cap CMOS LDO, 3.2V Output Voltage, -40°C to +125°C Temp. Range, 5-Pin SOT-23, 3,000/Reel				
f)	MIC5255-3.3YML-TR:	150 mA Low Noise $\mu$ Cap CMOS LDO, 3.3V Output Voltage, -40°C to +125°C Temp. Range, 6-Pin VDFN, 5,000/Reel				
<b>Note 1:</b>	Tape and Reel identifier only appears in the catalog part number description. This identifier is used for ordering purposes and is not printed on the device package. Check with your Microchip Sales Office for package availability with the Tape and Reel option.					

# MIC5255

---

NOTES:

---

**Note the following details of the code protection feature on Microchip devices:**

- Microchip products meet the specification contained in their particular Microchip Data Sheet.
- Microchip believes that its family of products is one of the most secure families of its kind on the market today, when used in the intended manner and under normal conditions.
- There are dishonest and possibly illegal methods used to breach the code protection feature. All of these methods, to our knowledge, require using the Microchip products in a manner outside the operating specifications contained in Microchip's Data Sheets. Most likely, the person doing so is engaged in theft of intellectual property.
- Microchip is willing to work with the customer who is concerned about the integrity of their code.
- Neither Microchip nor any other semiconductor manufacturer can guarantee the security of their code. Code protection does not mean that we are guaranteeing the product as “unbreakable.”

Code protection is constantly evolving. We at Microchip are committed to continuously improving the code protection features of our products. Attempts to break Microchip's code protection feature may be a violation of the Digital Millennium Copyright Act. If such acts allow unauthorized access to your software or other copyrighted work, you may have a right to sue for relief under that Act.

---

Information contained in this publication regarding device applications and the like is provided only for your convenience and may be superseded by updates. It is your responsibility to ensure that your application meets with your specifications. MICROCHIP MAKES NO REPRESENTATIONS OR WARRANTIES OF ANY KIND WHETHER EXPRESS OR IMPLIED, WRITTEN OR ORAL, STATUTORY OR OTHERWISE, RELATED TO THE INFORMATION, INCLUDING BUT NOT LIMITED TO ITS CONDITION, QUALITY, PERFORMANCE, MERCHANTABILITY OR FITNESS FOR PURPOSE. Microchip disclaims all liability arising from this information and its use. Use of Microchip devices in life support and/or safety applications is entirely at the buyer's risk, and the buyer agrees to defend, indemnify and hold harmless Microchip from any and all damages, claims, suits, or expenses resulting from such use. No licenses are conveyed, implicitly or otherwise, under any Microchip intellectual property rights unless otherwise stated.

*Microchip received ISO/TS-16949:2009 certification for its worldwide headquarters, design and wafer fabrication facilities in Chandler and Tempe, Arizona; Gresham, Oregon and design centers in California and India. The Company's quality system processes and procedures are for its PIC® MCUs and dsPIC® DSCs, KEELoc® code hopping devices, Serial EEPROMs, microperipherals, nonvolatile memory and analog products. In addition, Microchip's quality system for the design and manufacture of development systems is ISO 9001:2000 certified.*

**QUALITY MANAGEMENT SYSTEM  
CERTIFIED BY DNV  
= ISO/TS 16949 =**

### Trademarks

The Microchip name and logo, the Microchip logo, AnyRate, dsPIC, FlashFlex, flexPWR, Heldo, JukeBlox, KeeLoq, KeeLoq logo, Klear, LANCheck, LINK MD, MediaLB, MOST, MOST logo, MPLAB, OptoLyzer, PIC, PICSTART, PIC32 logo, RightTouch, SpyNIC, SST, SST Logo, SuperFlash and UNI/O are registered trademarks of Microchip Technology Incorporated in the U.S.A. and other countries.

ClockWorks, The Embedded Control Solutions Company, ETHERSYNCH, Hyper Speed Control, HyperLight Load, IntelliMOS, mTouch, Precision Edge, and QUIET-WIRE are registered trademarks of Microchip Technology Incorporated in the U.S.A.

Analog-for-the-Digital Age, Any Capacitor, AnyIn, AnyOut, BodyCom, chipKIT, chipKIT logo, CodeGuard, dsPICDEM, dsPICDEM.net, Dynamic Average Matching, DAM, ECAN, EtherGREEN, In-Circuit Serial Programming, ICSP, Inter-Chip Connectivity, JitterBlocker, KlearNet, KlearNet logo, MiWi, motorBench, MPASM, MPF, MPLAB Certified logo, MPLIB, MPLINK, MultiTRAK, NetDetach, Omniscient Code Generation, PICDEM, PICDEM.net, PICkit, PICtail, PureSilicon, RightTouch logo, REAL ICE, Ripple Blocker, Serial Quad I/O, SQL, SuperSwitcher, SuperSwitcher II, Total Endurance, TSHARC, USBCheck, VariSense, ViewSpan, WiperLock, Wireless DNA, and ZENA are trademarks of Microchip Technology Incorporated in the U.S.A. and other countries.

SQTP is a service mark of Microchip Technology Incorporated in the U.S.A.

Silicon Storage Technology is a registered trademark of Microchip Technology Inc. in other countries.

GestIC is a registered trademarks of Microchip Technology Germany II GmbH & Co. KG, a subsidiary of Microchip Technology Inc., in other countries.

All other trademarks mentioned herein are property of their respective companies.

© 2016, Microchip Technology Incorporated, Printed in the U.S.A., All Rights Reserved.

ISBN: 978-1-5224-1071-3



# MICROCHIP

## Worldwide Sales and Service

### AMERICAS

**Corporate Office**  
2355 West Chandler Blvd.  
Chandler, AZ 85224-6199  
Tel: 480-792-7200  
Fax: 480-792-7277  
Technical Support:  
<http://www.microchip.com/support>  
Web Address:  
[www.microchip.com](http://www.microchip.com)

**Atlanta**  
Duluth, GA  
Tel: 678-957-9614  
Fax: 678-957-1455

**Austin, TX**  
Tel: 512-257-3370

**Boston**  
Westborough, MA  
Tel: 774-760-0087  
Fax: 774-760-0088

**Chicago**  
Itasca, IL  
Tel: 630-285-0071  
Fax: 630-285-0075

**Dallas**  
Addison, TX  
Tel: 972-818-7423  
Fax: 972-818-2924

**Detroit**  
Novi, MI  
Tel: 248-848-4000

**Houston, TX**  
Tel: 281-894-5983

**Indianapolis**  
Noblesville, IN  
Tel: 317-773-8323  
Fax: 317-773-5453  
Tel: 317-536-2380

**Los Angeles**  
Mission Viejo, CA  
Tel: 949-462-9523  
Fax: 949-462-9608  
Tel: 951-273-7800

**Raleigh, NC**  
Tel: 919-844-7510

**New York, NY**  
Tel: 631-435-6000

**San Jose, CA**  
Tel: 408-735-9110  
Tel: 408-436-4270

**Canada - Toronto**  
Tel: 905-695-1980  
Fax: 905-695-2078

### ASIA/PACIFIC

**Asia Pacific Office**  
Suites 3707-14, 37th Floor  
Tower 6, The Gateway  
Harbour City, Kowloon

**Hong Kong**  
Tel: 852-2943-5100  
Fax: 852-2401-3431

**Australia - Sydney**  
Tel: 61-2-9868-6733  
Fax: 61-2-9868-6755

**China - Beijing**  
Tel: 86-10-8569-7000  
Fax: 86-10-8528-2104

**China - Chengdu**  
Tel: 86-28-8665-5511  
Fax: 86-28-8665-7889

**China - Chongqing**  
Tel: 86-23-8980-9588  
Fax: 86-23-8980-9500

**China - Dongguan**  
Tel: 86-769-8702-9880

**China - Guangzhou**  
Tel: 86-20-8755-8029

**China - Hangzhou**  
Tel: 86-571-8792-8115  
Fax: 86-571-8792-8116

**China - Hong Kong SAR**  
Tel: 852-2943-5100  
Fax: 852-2401-3431

**China - Nanjing**  
Tel: 86-25-8473-2460  
Fax: 86-25-8473-2470

**China - Qingdao**  
Tel: 86-532-8502-7355  
Fax: 86-532-8502-7205

**China - Shanghai**  
Tel: 86-21-3326-8000  
Fax: 86-21-3326-8021

**China - Shenyang**  
Tel: 86-24-2334-2829  
Fax: 86-24-2334-2393

**China - Shenzhen**  
Tel: 86-755-8864-2200  
Fax: 86-755-8203-1760

**China - Wuhan**  
Tel: 86-27-5980-5300  
Fax: 86-27-5980-5118

**China - Xian**  
Tel: 86-29-8833-7252  
Fax: 86-29-8833-7256

### ASIA/PACIFIC

**China - Xiamen**  
Tel: 86-592-2388138  
Fax: 86-592-2388130

**China - Zhuhai**  
Tel: 86-756-3210040  
Fax: 86-756-3210049

**India - Bangalore**  
Tel: 91-80-3090-4444  
Fax: 91-80-3090-4123

**India - New Delhi**  
Tel: 91-11-4160-8631  
Fax: 91-11-4160-8632

**India - Pune**  
Tel: 91-20-3019-1500

**Japan - Osaka**  
Tel: 81-6-6152-7160  
Fax: 81-6-6152-9310

**Japan - Tokyo**  
Tel: 81-3-6880-3770  
Fax: 81-3-6880-3771

**Korea - Daegu**  
Tel: 82-53-744-4301  
Fax: 82-53-744-4302

**Korea - Seoul**  
Tel: 82-2-554-7200  
Fax: 82-2-558-5932 or  
82-2-558-5934

**Malaysia - Kuala Lumpur**  
Tel: 60-3-6201-9857  
Fax: 60-3-6201-9859

**Malaysia - Penang**  
Tel: 60-4-227-8870  
Fax: 60-4-227-4068

**Philippines - Manila**  
Tel: 63-2-634-9065  
Fax: 63-2-634-9069

**Singapore**  
Tel: 65-6334-8870  
Fax: 65-6334-8850

**Taiwan - Hsin Chu**  
Tel: 886-3-5778-366  
Fax: 886-3-5770-955

**Taiwan - Kaohsiung**  
Tel: 886-7-213-7830

**Taiwan - Taipei**  
Tel: 886-2-2508-8600  
Fax: 886-2-2508-0102

**Thailand - Bangkok**  
Tel: 66-2-694-1351  
Fax: 66-2-694-1350

### EUROPE

**Austria - Wels**  
Tel: 43-7242-2244-39  
Fax: 43-7242-2244-393

**Denmark - Copenhagen**  
Tel: 45-4450-2828  
Fax: 45-4485-2829

**Finland - Espoo**  
Tel: 358-9-4520-820

**France - Paris**  
Tel: 33-1-69-53-63-20  
Fax: 33-1-69-30-90-79

**France - Saint Cloud**  
Tel: 33-1-30-60-70-00

**Germany - Garching**  
Tel: 49-8931-9700

**Germany - Haan**  
Tel: 49-2129-3766400

**Germany - Heilbronn**  
Tel: 49-7131-67-3636

**Germany - Karlsruhe**  
Tel: 49-721-625370

**Germany - Munich**  
Tel: 49-89-627-144-0  
Fax: 49-89-627-144-44

**Germany - Rosenheim**  
Tel: 49-8031-354-560

**Israel - Ra'anana**  
Tel: 972-9-744-7705

**Italy - Milan**  
Tel: 39-0331-742611  
Fax: 39-0331-466781

**Italy - Padova**  
Tel: 39-049-7625286

**Netherlands - Drunen**  
Tel: 31-416-690399  
Fax: 31-416-690340

**Norway - Trondheim**  
Tel: 47-7289-7561

**Poland - Warsaw**  
Tel: 48-22-3325737

**Romania - Bucharest**  
Tel: 40-21-407-87-50

**Spain - Madrid**  
Tel: 34-91-708-08-90  
Fax: 34-91-708-08-91

**Sweden - Gothenberg**  
Tel: 46-31-704-60-40

**Sweden - Stockholm**  
Tel: 46-8-5090-4654

**UK - Wokingham**  
Tel: 44-118-921-5800  
Fax: 44-118-921-5820

## X-ON Electronics

Largest Supplier of Electrical and Electronic Components

*Click to view similar products for [LDO Voltage Regulators](#) category:*

*Click to view products by [Microchip](#) manufacturer:*

Other Similar products are found below :

[AP7363-SP-13](#) [L79M05TL-E](#) [PT7M8202B12TA5EX](#) [TCR3DF185,LM\(CT](#) [TCR3DF24,LM\(CT](#) [TCR3DF285,LM\(CT](#) [TCR3DF31,LM\(CT](#)  
[TCR3DF45,LM\(CT](#) [MP2013GQ-33-Z](#) [059985X](#) [NCP4687DH15T1G](#) [701326R](#) [TCR2EN28,LF\(S](#) [NCV8170AXV250T2G](#)  
[TCR3DF27,LM\(CT](#) [TCR3DF19,LM\(CT](#) [TCR3DF125,LM\(CT](#) [TCR2EN18,LF\(S](#) [AP7315-25W5-7](#) [IFX30081LDVGRNXUMA1](#)  
[NCV47411PAAJR2G](#) [AP2113KTR-G1](#) [AP2111H-1.2TRG1](#) [ZLDO1117QK50TC](#) [AZ1117IH-1.8TRG1](#) [TCR3DG12,LF](#) [MIC5514-3.3YMT-](#)  
[T5](#) [MIC5512-1.2YMT-T5](#) [MIC5317-2.8YM5-T5](#) [SCD7912BTG](#) [NCP154MX180270TAG](#) [SCD33269T-5.0G](#) [NCV8170BMX330TCG](#)  
[NCV8170AMX120TCG](#) [NCP706ABMX300TAG](#) [NCP153MX330180TCG](#) [NCP114BMX075TCG](#) [MC33269T-3.5G](#) [CAT6243-ADJCMT5T](#)  
[TCR3DG33,LF](#) [AP2127N-1.0TRG1](#) [TCR4DG35,LF](#) [LT1117CST-3.3](#) [LT1117CST-5](#) [TAR5S15U\(TE85L,F\)](#) [TAR5S18U\(TE85L,F\)](#)  
[TCR3UG19A,LF](#) [TCR4DG105,LF](#) [NCV8170AMX360TCG](#) [MIC94310-NYMT-T5](#)