



MIC5306

150mA Micropower μ Cap Baseband LDO

General Description

The MIC5306 is a micropower, μ Cap low dropout regulator designed for optimal performance in a small space. It is capable of sourcing 150mA of output current and only draws 16 μ A of operating current. This high performance LDO offers fast transient response and good PSRR while consuming a minimum of current.

Ideal for battery operated applications; the MIC5306 offers 1% accuracy, extremely low dropout voltage (45mV @ 100mA). Equipped with a TTL logic compatible enable pin, the MIC5306 can be put into a zero-off-mode current state, drawing no current when disabled.

The MIC5306 is a μ Cap design, operating with very small ceramic output capacitors for stability, reducing required board space and component cost.

The MIC5306 is available in fixed output voltages in Thin SOT23-5 packaging.

Features

- Input voltage range: 2.25V to 5.5V
- Ultra-low I_Q : Only 16 μ A operating current
- Stable with ceramic output capacitor
- Low dropout voltage of 45mV @ 100mA
- High output accuracy
 - $\pm 1.0\%$ initial accuracy
 - $\pm 2.0\%$ over temperature
- Thermal Shutdown Protection
- Current Limit Protection

Applications

- Digital Logic Power Supply
- Stand-by power supply
- Cellular phones
- PDAs
- Portable electronics
- Notebook PCs

Typical Application

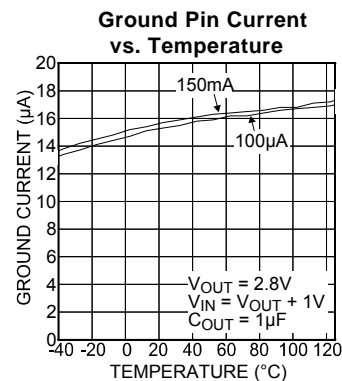
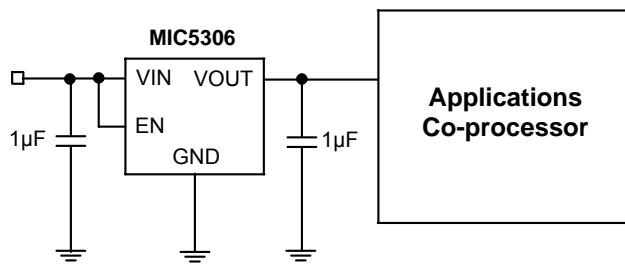

Block Diagram

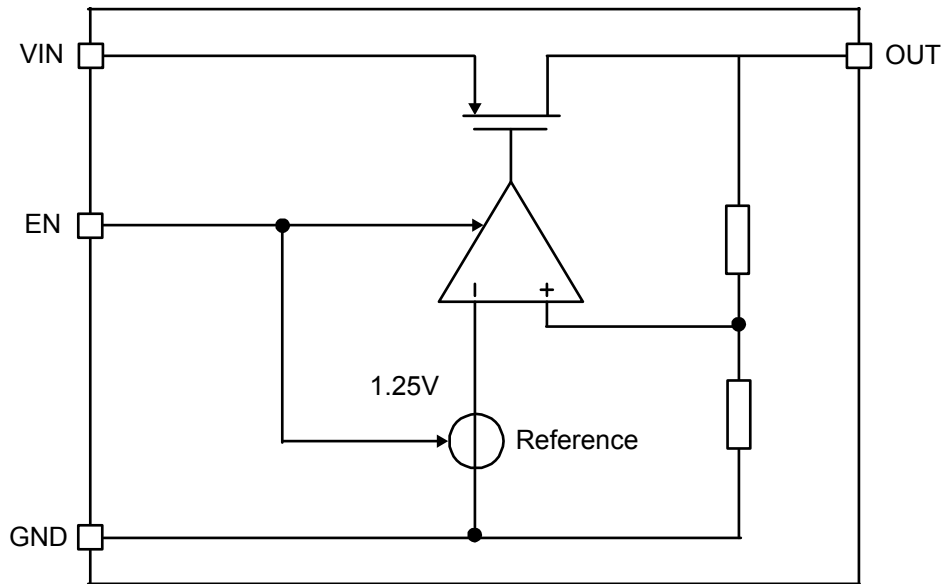

Ordering Information

Part Number	Marking Code*	Output Voltage**	Junction Temp. Range	Package
MIC5306-1.8YD5	<u>N9</u> 18	1.8V	-40°C to 125°C	TSOT23-5
MIC5306-2.5YD5	<u>N9</u> 25	2.5V	-40°C to 125°C	TSOT23-5
MIC5306-2.6YD5	<u>N9</u> 26	2.6V	-40°C to 125°C	TSOT23-5

Note:

* Under bar symbol may not to scale.

** For other voltage options. Contact Micrel for details.

Pin Configuration

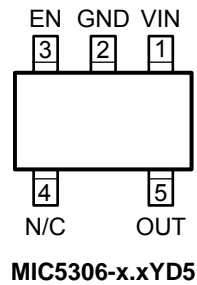

Pin Description

Pin Number	Pin Name	Pin Function
1	IN	Supply Input
2	GND	Ground
3	EN	Enable Input. Active High. High = on, low = off. Do not leave floating.
4	NC	No Connect
5	OUT	Output Voltage

Absolute Maximum Ratings⁽¹⁾

Supply Input Voltage (V_{IN})	0V to 6V
Enable Input Voltage (V_{EN})	0V to 6V
Power Dissipation (P_D)	Internally Limited ⁽³⁾
Junction Temperature	-40°C to +125°C
Lead Temperature (soldering, 5sec.)	260°C
Storage Temperature (T_s)	-65°C to +150°C

Operating Ratings⁽²⁾

Supply Input Voltage (V_{IN})	2.25V to 5.5V
Enable Input Voltage ($V_{EN1/EN2/LOWQ}$)	0V to V_{IN}
Junction Temperature (T_J)	-40°C to +125°C
TSOT23-5(θ_{JA})	235°C

Electrical Characteristics

$V_{IN} = V_{OUT} + 1.0V$; $C_{OUT} = 1.0\mu F$, $I_{OUT} = 100\mu A$; $T_J = 25^\circ C$, **bold** values indicate -40°C to +125, unless noted.

Parameter	Conditions	Min	Typ	Max	Units
Output Voltage Accuracy	Variation from nominal V_{OUT}	-1		+1	%
	Variation from nominal V_{OUT} ; -40°C to +125°C	-2		+2	%
Line Regulation	$V_{IN} = V_{OUT} + 1V$ to 5.5V		0.01	0.3 0.5	%/V
Load Regulation	$I_{OUT} = 100\mu A$ to 150mA		0.5	1 1.5	%
Dropout Voltage ⁽⁴⁾	$I_{OUT} = 50mA$		25		mV
	$I_{OUT} = 100mA$		45		
	$I_{OUT} = 150mA$		65	200	
Ground Pin Current	$I_{OUT} = 0mA$ to 150mA; $V_{IN} = 5.5V$		16	25	μA
Ground Pin Current in Shutdown	$V_{EN} \leq 0.2V$; $V_{IN} = 5.5V$		0.01	1	μA
Ripple Rejection	$f = 10Hz$ to 1kHz; $C_{OUT} = 1\mu F$; $I_{OUT} = 150mA$		62		dB
	$f = 20kHz$; $C_{OUT} = 1\mu F$; $I_{OUT} = 150mA$		35		
Current Limit	$V_{OUT} = 0V$	175	285	500	mA
Thermal Shutdown			150		°C
Thermal Shutdown Hysteresis			15		°C
Output Voltage Noise	$C_{OUT} = 1\mu F$; 10Hz to 100kHz		91		μV_{rms}
Enable Input					
Enable Input Voltage	Logic Low			0.2	V
	Logic High	1			V
Enable Input Current	$V_{IL} \leq 0.2V$		0.01	1	μA
	$V_{IH} \geq 1.0V$		0.01	1	μA
Turn-on Time ⁽⁵⁾	$C_{OUT} = 1\mu F$		250	500	μs

Notes:

- Exceeding the absolute maximum rating may damage the device.
- The device is not guaranteed to function outside its operating rating.
- The maximum allowable power dissipation of any T_A (ambient temperature) is $P_{D(max)} = T_{J(max)} - T_A / \theta_{JA}$. Exceeding the maximum allowable power dissipation will result in excessive die temperature, and the regulator will go into thermal shutdown.
- Dropout voltage is defined as the input-to-output differential at which the output voltage drops 2% below its nominal value measured at 1V differential. For outputs below 2.25V, dropout voltage is the input-to-output differential with the minimum input voltage 2.25V.
- Turn-on time is measured from $V_{en}=1V$ of the positive edge of the enable signal to 90% of the rising edge of the output voltage of the regulator.

Typical Characteristics

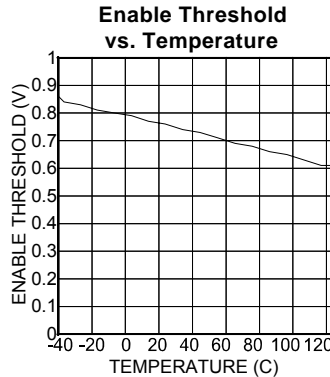
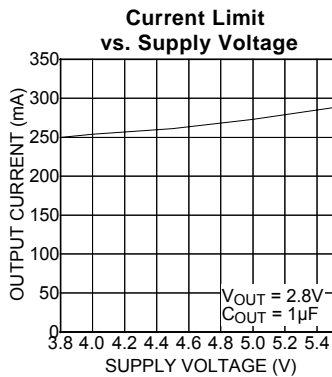
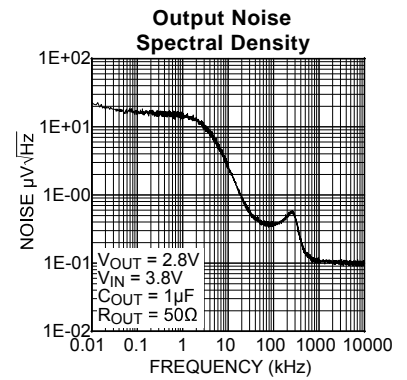
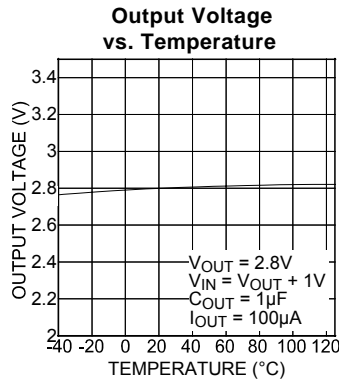
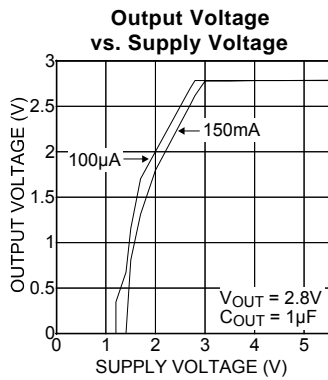
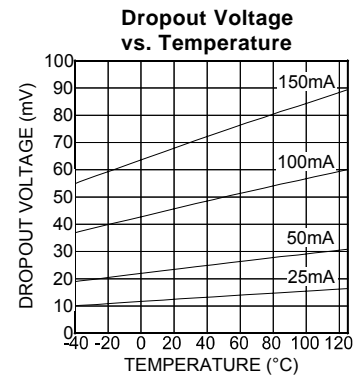
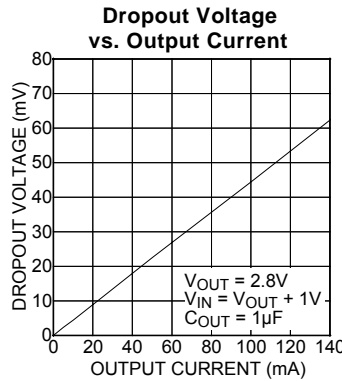
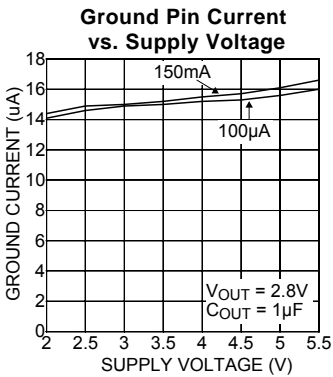
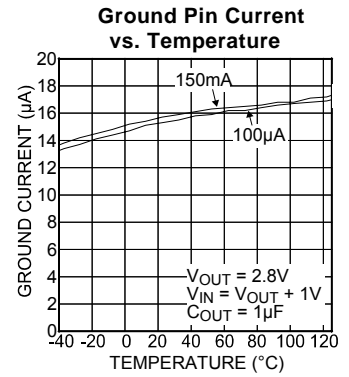
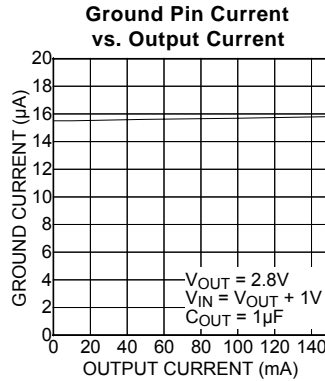
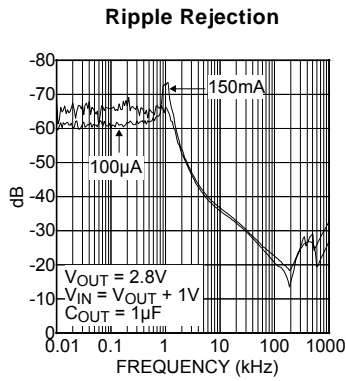

Functional Characteristics

Enable Turn-On Transient

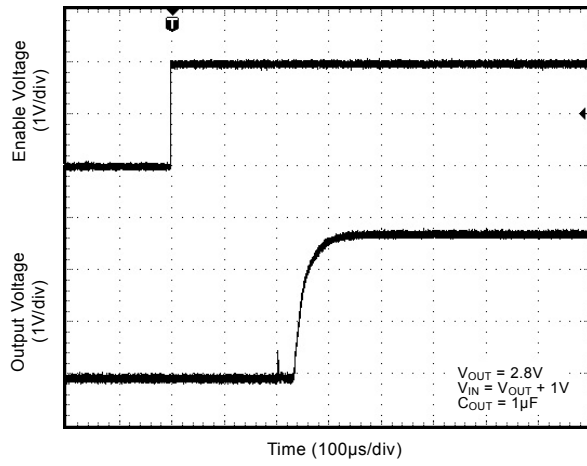

Line Transient Response

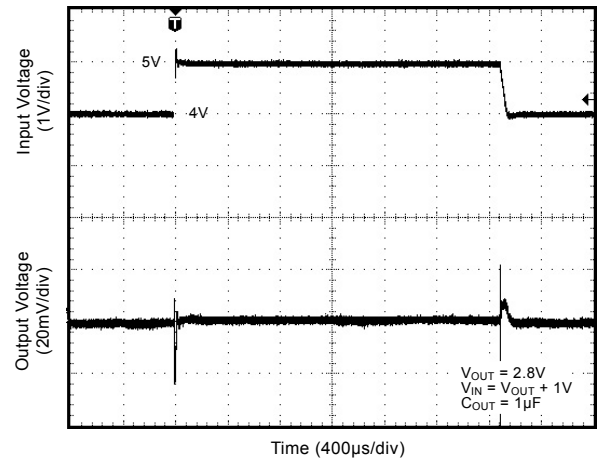

Load Transient Response

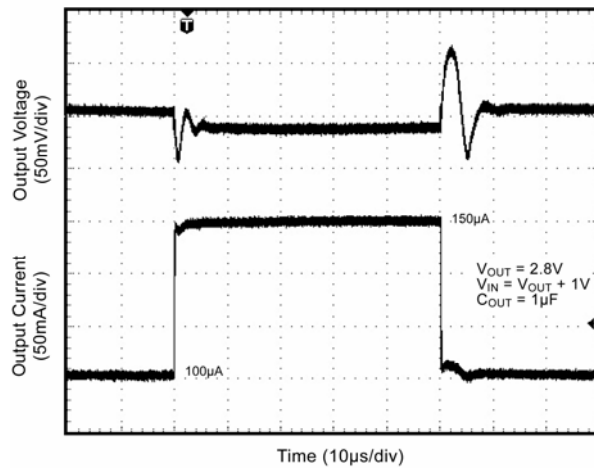

Applications Information

Input Capacitance

A 1 μ F capacitor should be placed from IN to GND if there is more than 10 inches of wire between the input and the ac filter capacitor or if a battery is used as the input.

Output Capacitance

An output capacitor is required between OUT and GND to prevent oscillation. Larger values improve the regulator's transient response. The output capacitor value may be increased without limit.

The output capacitor should have below ESR 300m Ω and a resonant frequency above 1MHz. Ultra-low-ESR capacitors can cause a low amplitude oscillation on the output and/or underdamped transient response. Most tantalum or aluminum electrolytic capacitors are adequate; film types will work, but are more expensive. Since many aluminum electrolytics have electrolytes that freeze at about -30°C , solid tantalums are recommended for operation below -25°C .

Enable

Forcing EN (enable/shutdown) high ($>1\text{V}$) enables the regulator. EN is compatible with CMOS logic gates. If the enable/shutdown feature is not required, connect EN (pin 3) to IN (supply input, pin 1).

Current Limit

There is overcurrent protection circuitry built into the MIC5306. Even with the output grounded, current will be limited to approximately 285mA. Further protection is provided by thermal shutdown.

Thermal Considerations

The MIC5306 is designed to provide 150mA of continuous current in a very small package. Maximum ambient operating temperature can be calculated based on the output current and the voltage drop across the part. Given that the input voltage is 3.8V, the output voltage is 2.8V and the output current equals 150mA.

The actual power dissipation of the regulator circuit can be determined using the equation:

$$P_D = (V_{IN} - V_{OUT}) I_{OUT} + V_{IN} I_{GND}$$

Because this device is CMOS and the ground current

is typically $< 50\mu\text{A}$ over the load range, the power dissipation contributed by the ground current is $< 1\%$ and can be ignored for this calculation.

$$P_D = (3.8\text{V} - 2.8\text{V}) \cdot 150\text{mA}$$

$$P_D = 0.15\text{W}$$

To determine the maximum ambient operating temperature of the package, use the junction-to-ambient thermal resistance of the device and the following basic equation:

$$P_{D(\text{max})} = \frac{T_{J(\text{max})} - T_A}{\theta_{JA}}$$

$T_{J(\text{max})} = 125^{\circ}\text{C}$, the maximum junction temperature of the die θ_{JA} thermal resistance = $235^{\circ}\text{C}/\text{W}$

Table 1 shows junction-to-ambient thermal resistance for the MIC5306 in the TSOT23-5 package.

Package	θ_{JA} Recommended Minimum Footprint	θ_{JC}
TSOT23-5	$235^{\circ}\text{C}/\text{W}$	$2^{\circ}\text{C}/\text{W}$

Table 1. TSOT23-5 Thermal Resistance

Substituting P_D for $P_{D(\text{max})}$ and solving for the ambient operating temperature will give the maximum operating conditions for the regulator circuit. The junction-to-ambient thermal resistance for the minimum footprint is $235^{\circ}\text{C}/\text{W}$, from Table 1. The maximum power dissipation must not be exceeded for proper operation.

For example, when operating the MIC5306-2.8 at an input voltage of 3.8V and 150mA load with a minimum footprint layout, the maximum ambient operating temperature T_A can be determined as follows:

$$0.15\text{W} = (125^{\circ}\text{C} - T) / 235^{\circ}\text{C}/\text{W}$$

$$T = 89.75^{\circ}\text{C}$$

Therefore, a 2.8V application at 150mA of output current can accept an ambient operating temperature of 89.8°C in a TSOT23-5 package. For a full discussion of heat sinking and thermal effects on voltage regulators, refer to the "Regulator Thermals" section of Micrel's *Designing with Low-Dropout Voltage Regulators* handbook. This information can be found on Micrel's website at:

http://www.micrel.com/_PDF/other/LDOBk_ds.pdf

Package Information

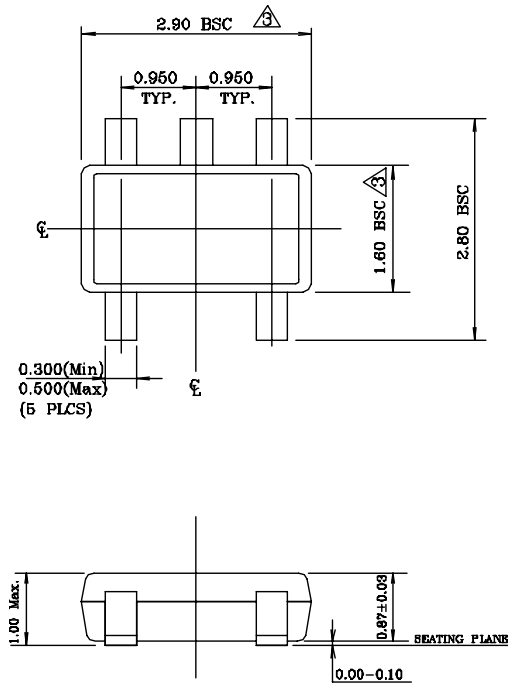

NOTE:

1. Dimensions and tolerances are as per ANSI Y14.5M, 1994.
2. Die is facing up for mold. Die is facing down for trim/form, ie. reverse trim/form.
3. Dimensions are exclusive of mold flash and gate burr.
4. The footlength measuring is based on the gauge plane method.
5. All specification comply to Jedec Spec MO193 Issue C.
6. All dimensions are in millimeters.

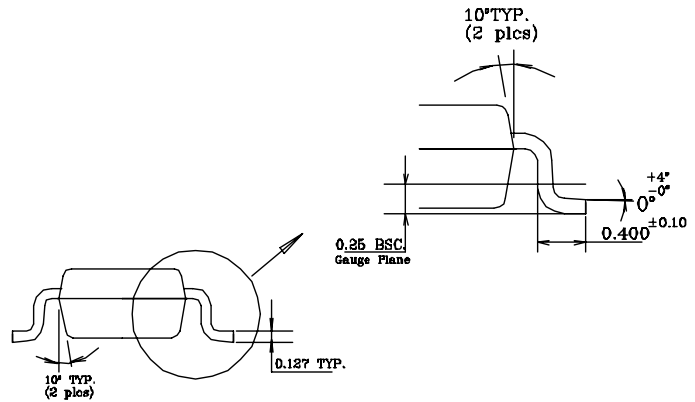

5-Pin TSOT-23

MICREL, INC. 2180 FORTUNE DRIVE SAN JOSE, CA 95131 USA
 TEL +1 (408) 944-0800 FAX +1 (408) 474-1000 WEB <http://www.micrel.com>

The information furnished by Micrel in this data sheet is believed to be accurate and reliable. However, no responsibility is assumed by Micrel for its use. Micrel reserves the right to change circuitry and specifications at any time without notification to the customer.

Micrel Products are not designed or authorized for use as components in life support appliances, devices or systems where malfunction of a product can reasonably be expected to result in personal injury. Life support devices or systems are devices or systems that (a) are intended for surgical implant into the body or (b) support or sustain life, and whose failure to perform can be reasonably expected to result in a significant injury to the user. A Purchaser's use or sale of Micrel Products for use in life support appliances, devices or systems is a Purchaser's own risk and Purchaser agrees to fully indemnify Micrel for any damages resulting from such use or sale.

© 2005 Micrel, Inc.

X-ON Electronics

Largest Supplier of Electrical and Electronic Components

Click to view similar products for [LDO Voltage Regulators](#) category:

Click to view products by [Microchip](#) manufacturer:

Other Similar products are found below :

[AP7363-SP-13](#) [L79M05TL-E](#) [PT7M8202B12TA5EX](#) [TCR3DF185,LM\(CT](#) [TCR3DF24,LM\(CT](#) [TCR3DF285,LM\(CT](#) [TCR3DF31,LM\(CT](#)
[TCR3DF45,LM\(CT](#) [MP2013GQ-33-Z](#) [059985X](#) [NCP4687DH15T1G](#) [701326R](#) [TCR2EN28,LF\(S](#) [NCV8170AXV250T2G](#)
[TCR3DF27,LM\(CT](#) [TCR3DF19,LM\(CT](#) [TCR3DF125,LM\(CT](#) [TCR2EN18,LF\(S](#) [AP7315-25W5-7](#) [IFX30081LDVGRNXUMA1](#)
[NCV47411PAAJR2G](#) [AP2113KTR-G1](#) [AP2111H-1.2TRG1](#) [ZLDO1117QK50TC](#) [AZ1117IH-1.8TRG1](#) [TCR3DG12,LF](#) [MIC5514-3.3YMT-](#)
[T5](#) [MIC5512-1.2YMT-T5](#) [MIC5317-2.8YM5-T5](#) [SCD7912BTG](#) [NCP154MX180270TAG](#) [SCD33269T-5.0G](#) [NCV8170BMX330TCG](#)
[NCV8170AMX120TCG](#) [NCP706ABMX300TAG](#) [NCP153MX330180TCG](#) [NCP114BMX075TCG](#) [MC33269T-3.5G](#) [CAT6243-ADJCMT5T](#)
[TCR3DG33,LF](#) [AP2127N-1.0TRG1](#) [TCR4DG35,LF](#) [LT1117CST-3.3](#) [LT1117CST-5](#) [TAR5S15U\(TE85L,F\)](#) [TAR5S18U\(TE85L,F\)](#)
[TCR3UG19A,LF](#) [TCR4DG105,LF](#) [NCV8170AMX360TCG](#) [MIC94310-NYMT-T5](#)