



MIC5338/9

Dual 300mA μ Cap LDO
in 1.6mm x 1.6mm Thin MLF[®]

General Description

The MIC5338/9 is an advanced dual 300mA LDO ideal for powering general purpose portable devices requiring low output noise and excellent Power Supply Rejection Ratio (PSRR). The MIC5338/9 provides two independently controlled, high performance, 300mA LDOs in a tiny 1.6mm x 1.6mm Thin MLF[®] package.

The MIC5338/9 provides two low noise outputs with fast transient response. Additionally the MIC5338/9 provides low quiescent current operation, using only 70 μ A with both outputs enabled. The MIC5339 also incorporates an active discharge feature that pulls down the output of the regulator when the part is disabled.

The MIC5338/9 is available in fixed output voltages in a lead-free (RoHS compliant) 6-pin 1.6mm x 1.6mm Thin MLF[®] leadless package.

Data sheets and support documentation can be found on Micrel's web site at www.micrel.com.

Features

- 2.5V to 5.5V input voltage range
- Two 300mA outputs
- High output accuracy – 2%
- Low quiescent current – 70 μ A total
- Stable with ceramic output capacitors
- Independent enable pins
- Low dropout voltage – 220mV at 300mA
- Low output noise
- Thermal shutdown protection
- Current limit protection
- Output discharge circuit – MIC5339
- 6-pin 1.6mm x 1.6mm Thin MLF[®] package

Applications

- Mobile phones
- Camera phones
- GPS, PMP, PDAs and handhelds
- Portable electronics

Typical Application

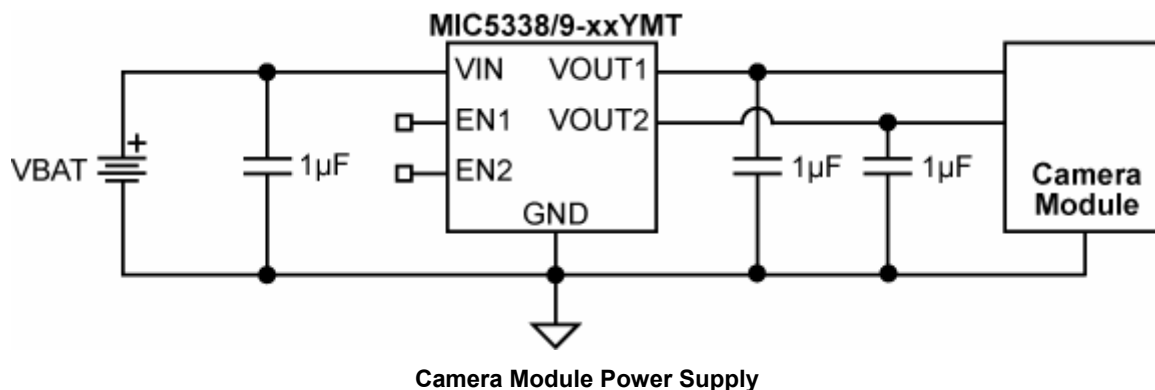

MLF and *MicroLeadFrame* are registered trademarks of Amkor Technology, Inc.

Micrel Inc. • 2180 Fortune Drive • San Jose, CA 95131 • USA • tel +1 (408) 944-0800 • fax + 1 (408) 474-1000 • <http://www.micrel.com>

Ordering Information

Part Number	Manufacturing Part Number	Marking Code	Voltage ⁽¹⁾	Junction Temp. Range	Package ⁽²⁾	Lead Finish ⁽³⁾
MIC5338-3.3/2.8YMT ¹	MIC5338-SMYMT	S82	3.3V/2.8V	-40° to +125°C	6-Pin 1.6x1.6 Thin MLF [®]	Pb-Free
MIC5338-2.8/1.8YMT	MIC5338-MGYMT	S83	2.8V/1.8V	-40° to +125°C	6-Pin 1.6x1.6 Thin MLF [®]	Pb-Free
MIC5338-2.8/1.2YMT ¹	MIC5338-M4YMT	S84	2.8V/1.2V	-40° to +125°C	6-Pin 1.6x1.6 Thin MLF [®]	Pb-Free
MIC5338-1.8/1.2YMT ¹	MIC5338-G4YMT	S85	1.8V/1.2V	-40° to +125°C	6-Pin 1.6x1.6 Thin MLF [®]	Pb-Free
MIC5338-1.2/1.0YMT ¹	MIC5338-4CYMT	S86	1.2V/1.0V	-40° to +125°C	6-Pin 1.6x1.6 Thin MLF [®]	Pb-Free
MIC5339-3.3/2.8YMT* ¹	MIC5339-SMYMT	S92	3.3V/2.8V	-40° to +125°C	6-Pin 1.6x1.6 Thin MLF [®]	Pb-Free
MIC5339-2.8/1.8YMT*	MIC5339-MGYMT	S93	2.8V/1.8V	-40° to +125°C	6-Pin 1.6x1.6 Thin MLF [®]	Pb-Free
MIC5339-2.8/1.2YMT* ¹	MIC5339-M4YMT	S94	2.8V/1.2V	-40° to +125°C	6-Pin 1.6x1.6 Thin MLF [®]	Pb-Free
MIC5339-1.8/1.2YMT* ¹	MIC5339-G4YMT	S95	1.8V/1.2V	-40° to +125°C	6-Pin 1.6x1.6 Thin MLF [®]	Pb-Free
MIC5339-1.2/1.0YMT* ¹	MIC5339-4CYMT	S96	1.2V/1.0V	-40° to +125°C	6-Pin 1.6x1.6 Thin MLF [®]	Pb-Free

Note:

- Contact Micrel for availability.
 - Thin MLF[®] Pin 1 Identifier= "▲"
 - Thin MLF[®] is a GREEN RoHS compliant package. Level finish is NiPdAu. Mold compound is Halogen Free.
- * MIC5339 offers Auto-Discharge function.

Pin Configuration

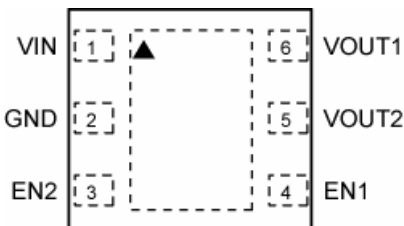

6-Pin 1.6mm x 1.6mm Thin MLF[®] (MT)

Pin Description

Pin Number	Pin Name	Pin Function
1	VIN	Supply Input.
2	GND	Ground.
3	EN2	Enable Input LDO2. Active High Input. Logic High = On; Logic Low = Off; Do not leave floating.
4	EN1	Enable Input LDO1. Active High Input. Logic High = On; Logic Low = Off; Do not leave floating.
5	VOUT2	LDO2 Output.
6	VOUT1	LDO1 Output.
EPAD	HSPAD	Heatsink pad. Connect to ground.

Absolute Maximum Ratings⁽¹⁾

Supply Voltage (V_{IN})	-0.3V to +6V
Enable Voltage (V_{EN1}, V_{EN2})	-0.3V to V_{IN}
Power Dissipation (P_D)	Internally Limited ⁽³⁾
Lead Temperature (soldering, 10sec.)	260°C
Junction Temperature (T_J)	-40°C to +125°C
Storage Temperature (T_S)	-65°C to +150°C
ESD Rating ⁽⁴⁾	ESD Sensitive

Operating Ratings⁽²⁾

Supply Voltage (V_{IN})	+2.5V to 5.5V
Enable Voltage (V_{EN1}, V_{EN2})	0V to V_{IN}
Junction Temperature (T_J)	-40°C to +125°C
Junction Thermal Resistance	
1.6mm x 1.6mm Thin MLF [®] (θ_{JA})	92.4°C/W

Electrical Characteristics⁽⁵⁾

$V_{IN} = V_{EN1} = V_{EN2} = V_{OUT} + 1V$; higher of the two outputs; $I_{OUTLDO1} = I_{OUTLDO2} = 100\mu A$; $C_{OUT1} = C_{OUT2} = 1\mu F$;
 $T_J = 25^\circ C$, **bold** values indicate -40°C to +125°C, unless noted.

Parameter	Condition	Min	Typ	Max	Units
Output Voltage Accuracy	Variation from nominal V_{OUT}	-2.0		+2.0	%
	Variation from nominal V_{OUT}	-3.0		+3.0	%
Line Regulation	$V_{IN} = V_{OUT} + 1V$ to 5.5V, $I_{OUT} = 100\mu A$		0.02	0.3	%/V
Load Regulation	$I_{OUT} = 100\mu A$ to 300mA		0.3	1	%
Dropout Voltage	$I_{OUT} = 50mA$		35	65	mV
	$I_{OUT} = 300mA$		220	380	mV
Ground Pin Current	$V_{EN1} = \text{High}; V_{EN2} = \text{Low}; I_{OUT1} = 0mA$		38	58	μA
	$V_{EN1} = \text{Low}; V_{EN2} = \text{High}; I_{OUT2} = 0mA$		38	58	μA
	$V_{EN1} = V_{EN2} = \text{High}; I_{OUT1} = I_{OUT2} = 0mA$		70	110	μA
	$V_{EN1} = \text{High}; V_{EN2} = \text{Low}; I_{OUT1} = 300mA$		55	70	μA
	$V_{EN1} = \text{Low}; V_{EN2} = \text{High}; I_{OUT2} = 300mA$		55	70	μA
	$V_{EN1} = V_{EN2} = \text{High}; I_{OUT1} = I_{OUT2} = 300mA$		105	135	μA
Shutdown Current	$V_{EN1} = V_{EN2} \leq 0.2V$		0.05	1	μA
Ripple Rejection	$f = 1kHz; C_{OUT} = 1\mu F$		55		dB
Current Limit	$V_{OUT} = 0V$	325	500	680	mA
Output Voltage Noise	$C_{OUT} = 1\mu F, 10Hz$ to 100kHz		200		μV_{RMS}
Auto-Discharge NFET Resistance	MIC5339 Only; $V_{EN1} = V_{EN2} = 0V; V_{IN} = 3.6V; I_{OUT} = -3mA$		30		Ω

Enable Inputs (EN1/EN2)

Enable Input Voltage	Logic Low			0.2	V
	Logic High	1.2			V
Enable Input Current	$V_{IL} \leq 0.2V$		0.01	1	μA
	$V_{IH} \geq 1.2V$		0.01	1	μA
Turn-on Time			50	125	μs

Notes:

- Exceeding the absolute maximum rating may damage the device.
- The device is not guaranteed to function outside its operating rating.
- The maximum allowable power dissipation of any T_A (ambient temperature) is $P_{D(max)} = (T_{J(max)} - T_A) / \theta_{JA}$. Exceeding the maximum allowable power dissipation will result in excessive die temperature, and the regulator will go into thermal shutdown.
- Devices are ESD sensitive. Handling precautions recommended. Human body model, 1.5k Ω in series with 100pF.
- Specification for packaged product only.

Typical Characteristics

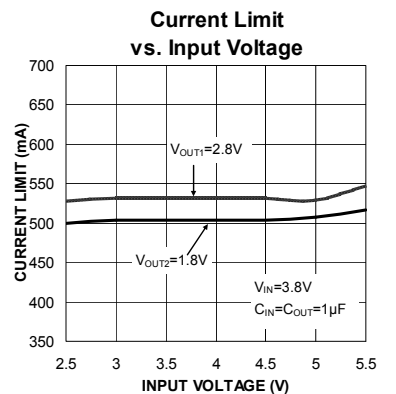
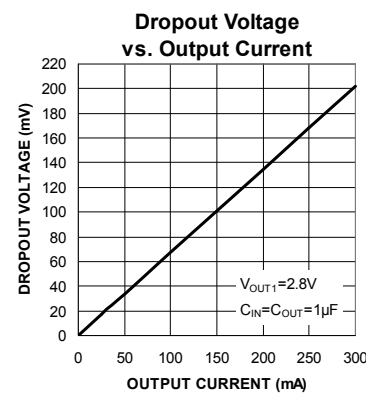
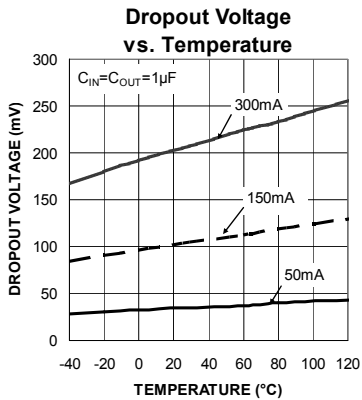
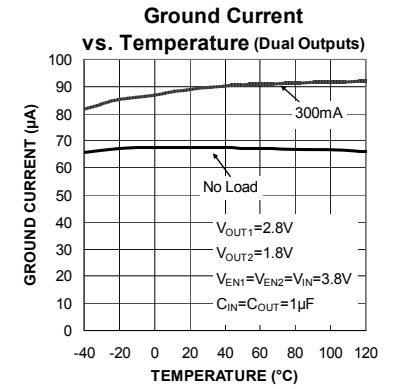
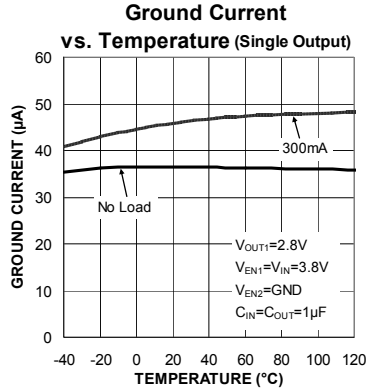
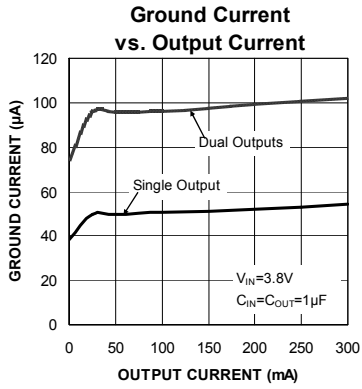
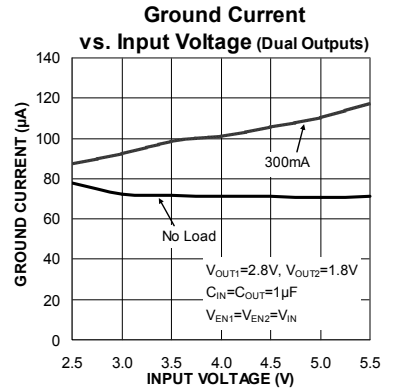
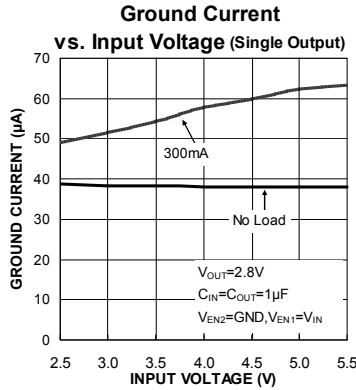
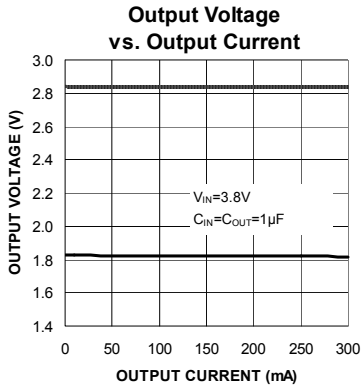
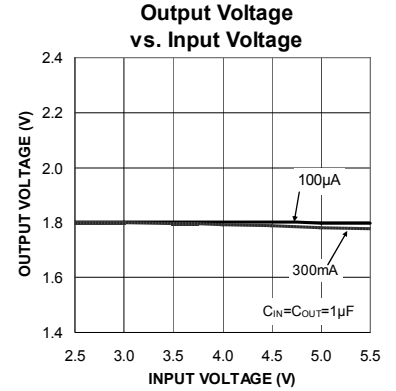
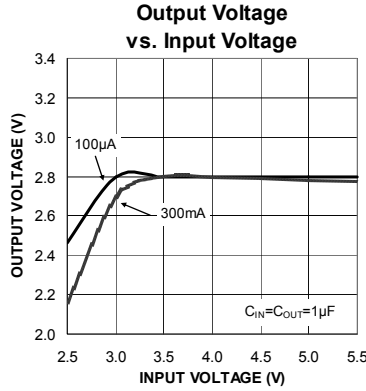
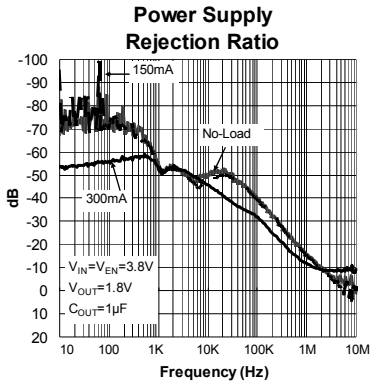

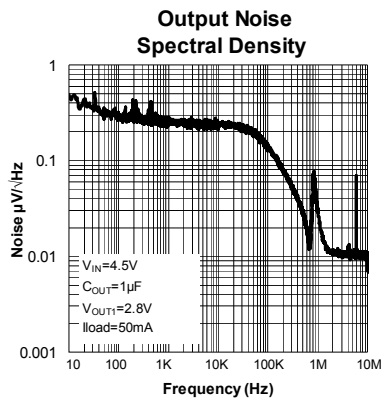

Functional Characteristics

Turn-On Time

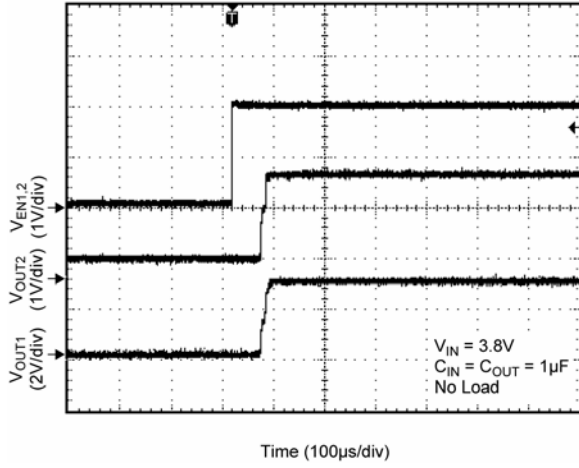

Turn-Off Time (MIC5339 Auto Discharge Function)

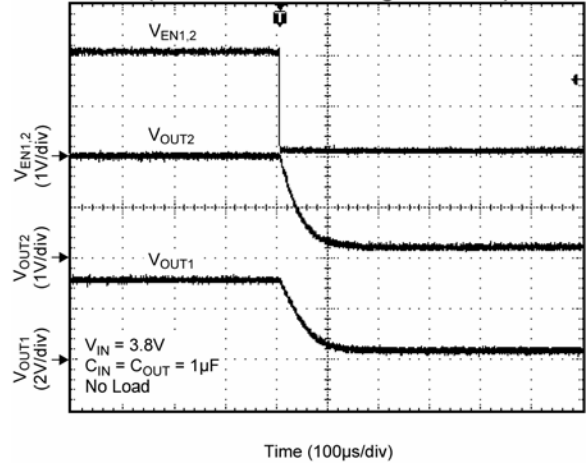

Load Transient

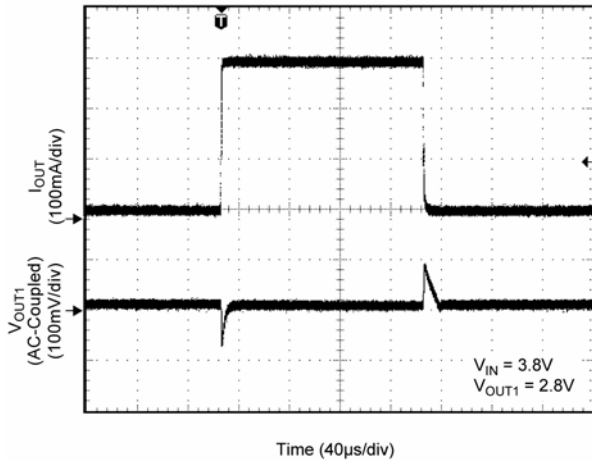

Load Transient

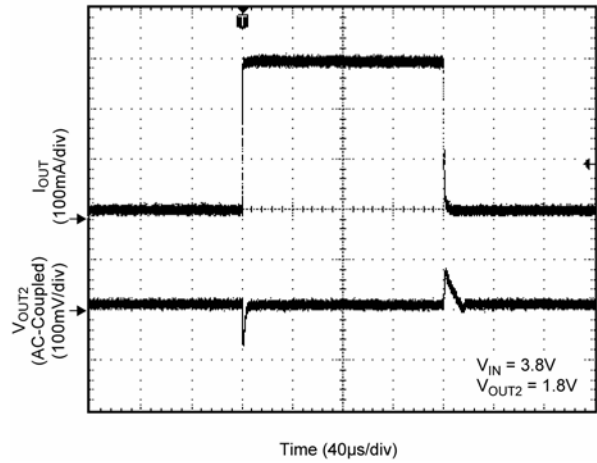

Line Transient

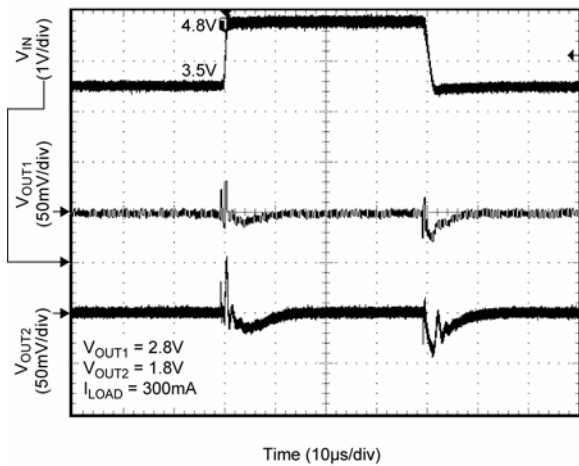

Functional Diagrams

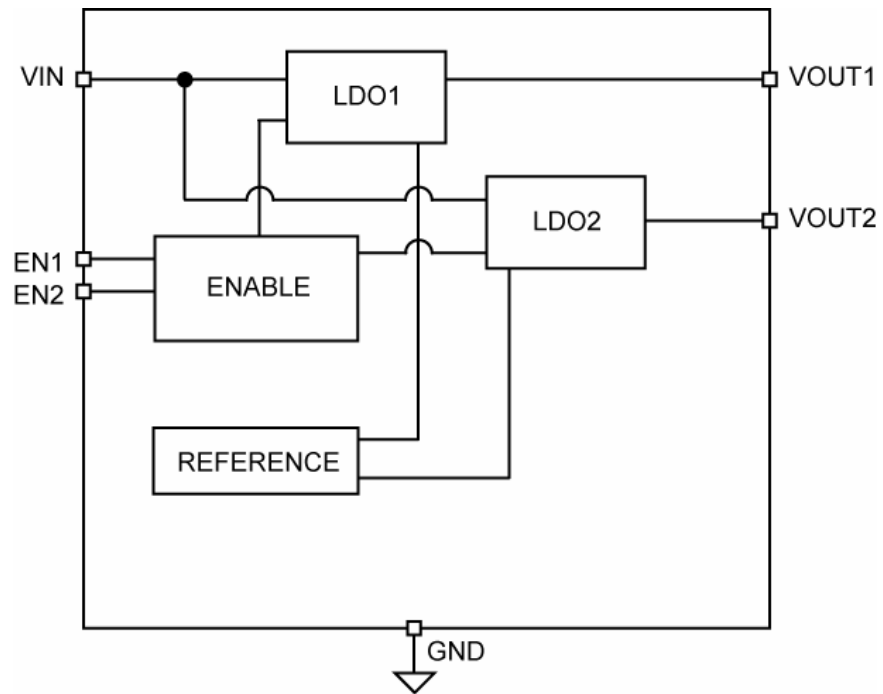

MIC5338 Block Diagram

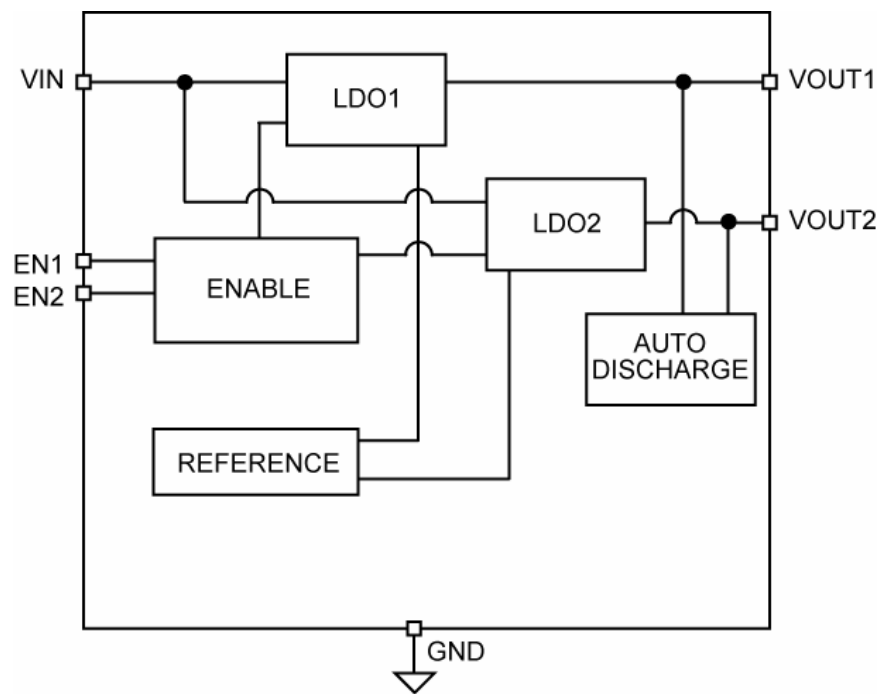

MIC5339 Block Diagram

Application Information

MIC5338/9 is a dual 300mA LDO. The MIC5339 includes an auto-discharge circuit for each LDO output that is activated when the output is disabled. The MIC5338/9 regulator is fully protected from damage due to fault conditions through linear current limiting and thermal shutdown.

Input Capacitor

The MIC5338/9 is a high performance, high bandwidth device. An input capacitor of 1 μ F from the input pin to ground is required to provide stability. Low ESR ceramic capacitors provide optimal performance in small board area. Additional high frequency capacitors, such as small valued NPO dielectric type capacitors, help filter out high frequency noise and are good practice in any RF based circuit. X5R or X7R dielectrics are recommended for the input capacitor. Y5V dielectrics lose most of their capacitance over temperature and are therefore not recommended.

Output Capacitor

The MIC5338/9 requires an output capacitor of 1 μ F or greater to maintain stability. The design is optimized for use with low ESR ceramic chip capacitors. High ESR capacitors may cause high frequency oscillation. The output capacitor can be increased, but performance has been optimized for a 1 μ F ceramic output capacitor and does not improve significantly with larger capacitance.

X7R and X5R dielectric ceramic capacitors are recommended because of their temperature performance. X7R capacitors change capacitance by 15% over their operating temperature range and are the most stable type of ceramic capacitors. Z5U and Y5V dielectric capacitors change value by as much as 50% and 60% respectively over their operating temperature ranges. To use a ceramic chip capacitor with Y5V dielectric the value must be much higher than an X7R ceramic capacitor to ensure the same minimum capacitance over the equivalent operating temperature range.

No Load Stability

Unlike many other voltage regulators, the MIC5338/9 will remain stable and in regulation with no load.

Enable/Shutdown

The MIC5338/9 comes with two active high enable pins that allow each regulator to be disabled independently. Forcing the enable pin low disables the regulator and sends it into an off mode current state drawing virtually zero current. When disabled, the MIC5339 switches an internal 30 Ω load on the regulator output to discharge the external capacitor.

Forcing the enable pin high enables the output voltage. The active high enable pin uses CMOS technology and cannot be left floating. A floating enable pin may cause an indeterminate state on the output.

Thermal Considerations

The MIC5338/9 is designed to provide two 300mA continuous current outputs in a very small package. Maximum operating temperature can be calculated based on the output currents and the voltage drop across the part. For example, if the input voltage is 3.6V, $V_{OUT1} = 3.3V$, $V_{OUT2} = 2.8V$ and each with an output current = 300mA. The actual power dissipation of the regulator circuit can be determined using the equation:

$$P_D = (V_{IN} - V_{OUT1}) I_{OUT1} + (V_{IN} - V_{OUT2}) I_{OUT2} + V_{IN} I_{GND}$$

Because this is CMOS device and the ground current is typically <100 μ A over the load range, the power dissipation contributed by the ground current is < 1% which can be ignored for this calculation.

$$P_D = (3.6V - 3.3V) \times 300mA + (3.6V - 2.8V) \times 300mA$$

$$P_D = 0.33W$$

To determine the maximum ambient operating temperature of the package, use the junction to ambient thermal resistance of the device and the following basic equation:

$$P_{D(MAX)} = \left(\frac{T_{J(MAX)} - T_A}{\theta_{JA}} \right)$$

$$T_{J(MAX)} = 125^\circ C$$

$$\theta_{JA} = 92.4^\circ C/W$$

Substituting P_D for $P_{D(MAX)}$ and solving for the ambient operating temperature will give the maximum operating conditions for the regulator circuit. The junction to ambient thermal resistance for the minimum footprint is 92.4 $^\circ$ C/W.

The maximum power dissipation must not be exceeded for proper operation.

For example, when operating a 3.3V/2.8V application with an input voltage of 3.6V and 300mA at each output with a minimum footprint layout, the maximum ambient operating temperature T_A can be determined as follows:

$$0.33W = (125^{\circ}\text{C} - T_A)/(92.4^{\circ}\text{C/W})$$

$$T_A = 94.5^{\circ}\text{C}$$

Therefore, a MIC5338-SMYMT application with 300mA at each output current can accept an ambient operating temperature of 94.5°C in a 1.6mm x 1.6mm Thin MLF[®] package. For a full discussion of heat sinking and thermal effects on voltage regulators refer to the "Regulator Thermals" section of *Micrel's Designing with Low-Dropout Voltage Regulators* handbook. This information can be found on Micrel's website at:
http://www.micrel.com/_PDF/other/LDOBk_ds.pdf

Typical Application Schematic

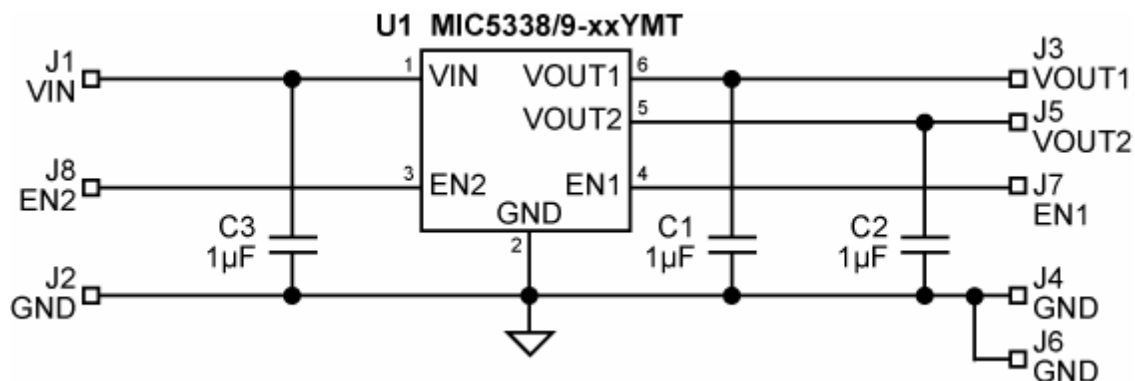

Bill of Materials

Item	Part Number	Manufacturer	Description	Qty.
C1, C2, C3	GRM188R60J225KE19D	Murata ⁽¹⁾	Capacitor, 1µF Ceramic, 6.3V, X5R, Size 0603	3
U1	MIC5338/9-xxYMT	Micrel ⁽²⁾	Dual, 300mA LDO, Size 1.6mm x 1.6mm Thin MLF®	1

Notes:

1. Murata: www.murata.com
2. Micrel, Inc.: www.micrel.com

PCB Layout Recommendations

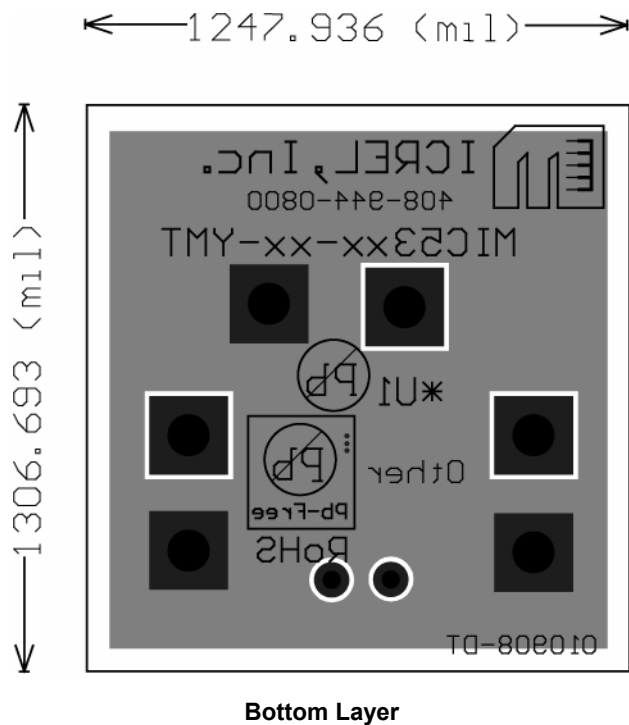
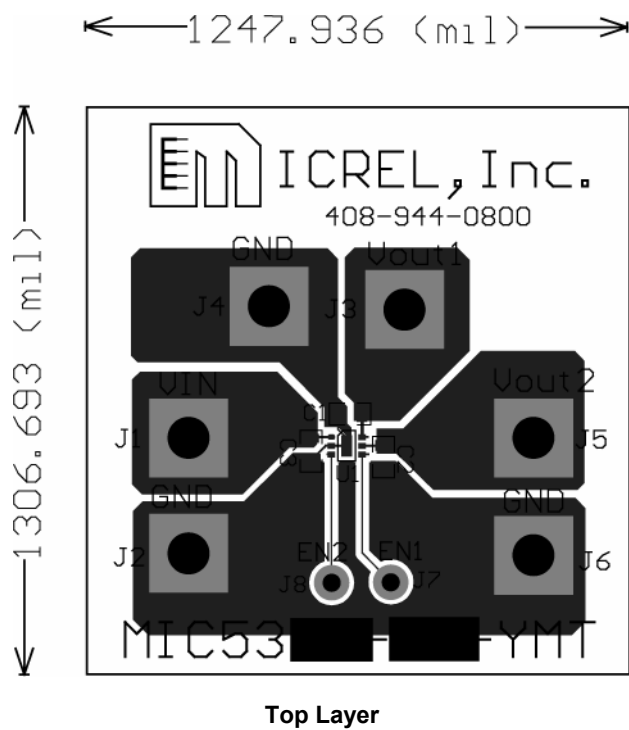

Package Information

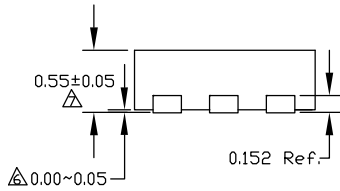
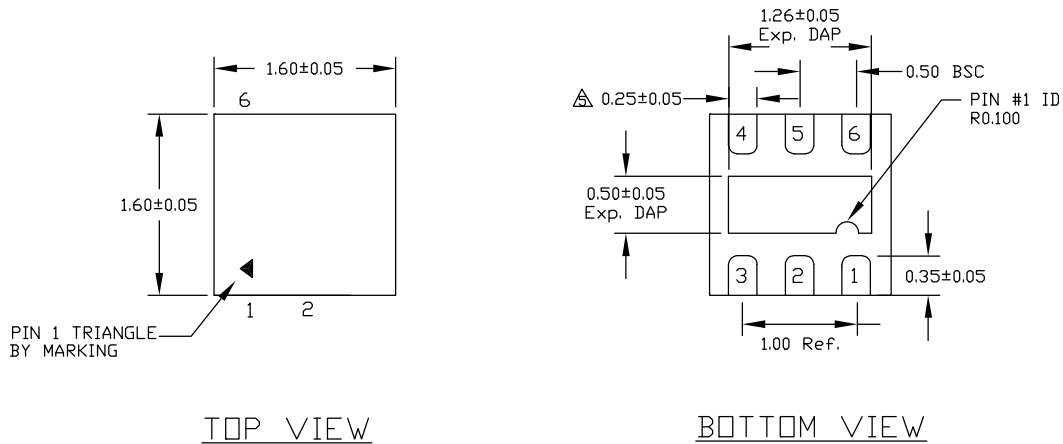

- NOTE:
1. ALL DIMENSIONS ARE IN MILLIMETERS.
 2. MAX. PACKAGE WARPAGE IS 0.05 mm.
 3. MAXIMUM ALLOWABLE BURRS IS 0.076 mm IN ALL DIRECTIONS.
 4. PIN #1 ID ON TOP WILL BE LASER/INK MARKED.
- △ DIMENSION APPLIES TO METALIZED TERMINAL AND IS MEASURED BETWEEN 0.20 AND 0.25 mm FROM TERMINAL TIP.
- △ APPLIED ONLY FOR TERMINALS.
- △ APPLIED FOR EXPOSED PAD AND TERMINALS.

6-Pin 1.6mm x 1.6mm Thin MLF® (MT)

MICREL, INC. 2180 FORTUNE DRIVE SAN JOSE, CA 95131 USA
 TEL +1 (408) 944-0800 FAX +1 (408) 474-1000 WEB <http://www.micrel.com>

The information furnished by Micrel in this data sheet is believed to be accurate and reliable. However, no responsibility is assumed by Micrel for its use. Micrel reserves the right to change circuitry and specifications at any time without notification to the customer.

Micrel Products are not designed or authorized for use as components in life support appliances, devices or systems where malfunction of a product can reasonably be expected to result in personal injury. Life support devices or systems are devices or systems that (a) are intended for surgical implant into the body or (b) support or sustain life, and whose failure to perform can be reasonably expected to result in a significant injury to the user. A Purchaser's use or sale of Micrel Products for use in life support appliances, devices or systems is a Purchaser's own risk and Purchaser agrees to fully indemnify Micrel for any damages resulting from such use or sale.

© 2010 Micrel, Incorporated.

X-ON Electronics

Largest Supplier of Electrical and Electronic Components

Click to view similar products for [LDO Voltage Regulators](#) category:

Click to view products by [Microchip](#) manufacturer:

Other Similar products are found below :

[M38D29FFHP#U1](#) [702103A](#) [717726C](#) [742457H](#) [MP20051DN-LF-Z](#) [R5F111PGGFB#30](#) [AP7363-SP-13](#) [NCP103AMX285TCG](#)
[NCV8664CST33T3G](#) [NCV8752AMX28TCG](#) [L9454](#) [AP7362-HA-7](#) [LX13043CLD](#) [TCR3DF185,LM\(CT](#) [TCR3DF24,LM\(CT](#)
[TCR3DF285,LM\(CT](#) [TCR3DF31,LM\(CT](#) [TCR3DF45,LM\(CT](#) [TLF4949EJ](#) [MP2013GQ-33-Z](#) [L9708](#) [L970813TR](#) [030014BB](#) [059985X](#)
[EAN61387601](#) [EAN61573601](#) [NCP121AMX173TCG](#) [NCP4687DH15T1G](#) [NCV8703MX30TCG](#) [701326R](#) [702087BB](#) [755078E](#)
[TCR2EN28,LF\(S](#) [LM1117DT-1.8/NO](#) [LT1086CM#TRPBF](#) [AZ1085S2-1.5TRE1](#) [MAX15101EWL+T](#) [NCV8170AXV250T2G](#)
[TCR3DF27,LM\(CT](#) [TCR3DF19,LM\(CT](#) [TCR3DF125,LM\(CT](#) [TCR2EN18,LF\(S](#) [MAX15103EWL+T](#) [TS2937CZ-5.0 C0](#) [MAX8878EUK30-](#)
[T](#) [MAX663CPA](#) [NCV4269CPD50R2G](#) [NCV8716MT30TBG](#) [AZ1117IH-1.2TRG1](#) [MP2013GQ-P](#)