



MIC5524

High-Performance 500mA LDO in Thin DFN Package

General Description

The MIC5524 is a low-power, μ Cap, low dropout regulator designed for optimal performance in a very-small footprint. It is capable of sourcing 500mA of output current and only draws 38 μ A of operating current to do so. The MIC5524 includes an auto-discharge feature on the output that is activated when the enable pin is low and it has an internal pull down resistor on the enable pin that will disable the output when the enable pin is left floating, this is ideal for applications where the control signal is floating during processor boot up.

This high-performance LDO offers fast transient response and good PSRR in a 1mm x 1mm Thin (0.4mm ht.) DFN package.

Ideal for battery-operated applications, the MIC5524 offers 2% accuracy, extremely low dropout voltage (260mV @ 500mA), and can regulate output voltages down to 1.0V. Equipped with a TTL logic-compatible enable pin, the MIC5524 can be put into a zero-off-mode current state, drawing no current when disabled.

The MIC5524 is a μ Cap design, operating with very small ceramic output capacitors for stability, reducing required board space and component cost for space-critical applications. The MIC5524 has an operating junction temperature range of -40°C to 125°C .

Datasheets and support documentation are available on Micrel's web site at: www.micrel.com.

Features

- Input voltage range: 2.5V to 5.5V
- Fixed output voltages down to 1.0V
- 500mA guaranteed output current
- High output initial accuracy ($\pm 1\%$)
- High PSRR 80dB
- Low quiescent current 38 μ A
- Stable with 2.2 μ F ceramic output capacitors
- Low dropout voltage 260mV @ 500mA
- Auto discharge and internal enable pulldown
- Thermal-shutdown and current-limit protection
- 4-pin 1mm x 1mm Thin DFN package

Applications

- Portable communication equipment
- DSC, GPS, PMP, and PDAs
- Portable medical devices
- 5V POL applications

Typical Application

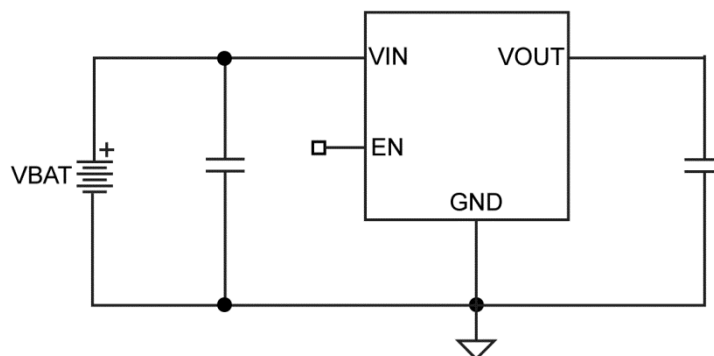

Ordering Information

Part Number	Marking Code	Output Voltage ⁽¹⁾	Temperature Range	Package ^(2, 3)
MIC5524-1.2YMT	C9	1.2V	-40°C to +125°C	4-Pin 1mm x 1mm TDFN
MIC5524-1.8YMT	C6	1.8V	-40°C to +125°C	4-Pin 1mm x 1mm TDFN
MIC5524-2.8YMT	4C	2.8V	-40°C to +125°C	4-Pin 1mm x 1mm TDFN
MIC5524-3.0YMT	3C	3.0V	-40°C to +125°C	4-Pin 1mm x 1mm TDFN
MIC5524-3.3YMT	C3	3.3V	-40°C to +125°C	4-Pin 1mm x 1mm TDFN

Note:

- Other voltages available. Contact Micrel for details.
- Thin DFN ▲ = Pin 1 identifier.
- Thin DFN is a GREEN, RoHS-compliant package. Lead finish is NiPdAu. Mold compound is Halogen Free.

Pin Configuration

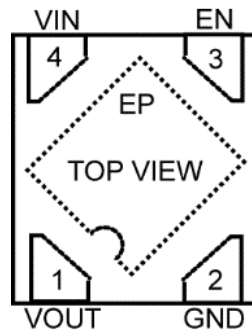

4-Pin 1mm x 1mm Thin DFN (MT)
(Top View)

Pin Description

Pin Number	Pin Name	Pin Function
1	VOUT	Output Voltage. When disabled the MIC5524 switches in an internal 25Ω load to discharge the external capacitors.
2	GND	Ground.
3	EN	Enable Input. Active High. High = ON; Low = OFF. The MIC5524 has an internal 4MΩ pulldown and this pin can be left floating.
4	VIN	Supply Input.
EP	ePad	Exposed Heatsink Pad. Connect to GND.

Absolute Maximum Ratings⁽⁴⁾

Supply Voltage (V_{IN})	-0.3V to 6V
Enable Voltage (V_{EN})	-0.3V to V_{IN}
Power Dissipation (P_D)	Internally Limited ⁽⁶⁾
Lead Temperature (soldering, 10s)	260°C
Junction Temperature (T_J)	-40°C to +150°C
Storage Temperature (T_S)	-65°C to +150°C
ESD Rating ⁽⁷⁾	3kV

Operating Ratings⁽⁵⁾

Supply Voltage (V_{IN})	2.5V to 5.5V
Enable Voltage (V_{EN})	0V to V_{IN}
Junction Temperature (T_J)	-40°C to +125°C
Junction Thermal Resistance 1mm x 1mm Thin DFN-4 (θ_{JA})	250°C/W

Electrical Characteristics⁽⁸⁾

$V_{IN} = V_{EN} = V_{OUT} + 1V$; $C_{IN} = C_{OUT} = 2.2\mu F$; $I_{OUT} = 100\mu A$; $T_J = 25^\circ C$, **bold** values indicate -40°C to 125°C, unless noted.

Parameter	Condition	Min.	Typ.	Max.	Units
Output Voltage Accuracy	Variation from nominal V_{OUT}	-2.0	± 1	+2.0	%
	Variation from nominal V_{OUT}	-3.0		+3.0	
Line Regulation	$V_{IN} = V_{OUT} + 1V$ to 5.5V; $I_{OUT} = 100\mu A$		0.02	0.3	%/V
Load Regulation ⁽⁹⁾	$I_{OUT} = 100\mu A$ to 500mA		10		mV
Dropout Voltage ⁽¹⁰⁾	$I_{OUT} = 150mA$		80	175	mV
	$I_{OUT} = 500mA$		260	500	
Ground Pin Current ⁽¹¹⁾	$I_{OUT} = 0mA$		38	55	μA
	$I_{OUT} = 500mA$		42		
Ground Pin Current in Shutdown	$V_{EN} = 0V$		0.05	1	μA
Ripple Rejection	$f = 100Hz$		80		dB
	$f = 1kHz$		65		dB
Current Limit	$V_{OUT} = 0V$	525	800		mA
Output Voltage Noise	$f = 10Hz$ to 100kHz		80		μV_{RMS}
Auto-Discharge NFET Resistance	$V_{EN} = 0V$; $V_{IN} = 3.6V$ $I_{OUT} = -3mA$		25		Ω
Enable Input					
Enable Pulldown Resistor			4		M Ω
Enable Input Voltage	Logic Low			0.2	V
	Logic High	1.2			
Enable Input Current	$V_{EN} = 0V$		0.01	1	μA
	$V_{EN} = 5.5V$		1.4	2	
Turn-On Time	$I_{OUT} = 150mA$		50	125	μs

Notes:

- Exceeding the absolute maximum rating can damage the device.
- The device is not guaranteed to function outside its operating rating.
- The maximum allowable power dissipation of any T_A (ambient temperature) is $P_{D(max)} = (T_{J(max)} - T_A) / \theta_{JA}$. Exceeding the maximum allowable power dissipation will result in excessive die temperature, and the regulator will go into thermal shutdown.
- Devices are ESD sensitive. Handling precautions are recommended. Human body model, 1.5k Ω in series with 100pF.
- Specification for packaged product only.
- Regulation is measured at constant junction temperature using low duty cycle pulse testing. Changes in output voltage due to heating effects are covered by the thermal regulation specification.
- Dropout voltage is defined as the input-to-output differential at which the output voltage drops 2% below its nominal value measured at 1V differential. For outputs below 2.5V, dropout voltage is the input-to-output differential with the minimum input voltage 2.5V.
- Ground pin current is the regulator quiescent current. The total current drawn from the supply is the sum of the load current plus the ground pin current.

Typical Characteristics

Power Supply Rejection Ratio

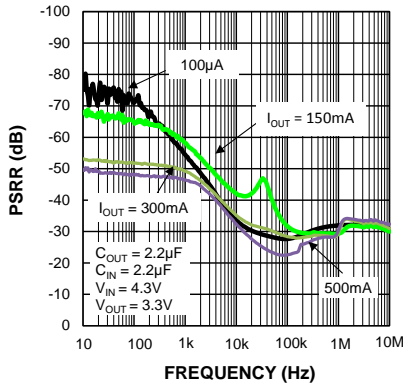

Dropout Voltage vs. Output Current

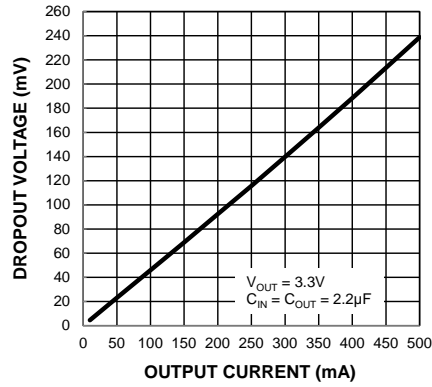

Dropout Voltage vs. Temperature

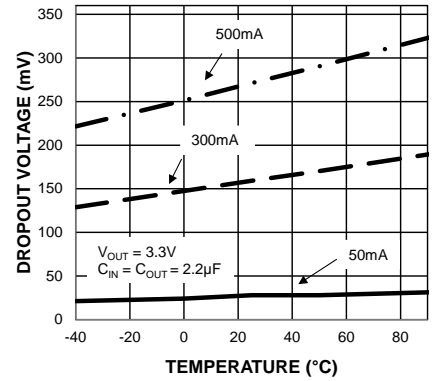

Ground Current vs. Supply Voltage

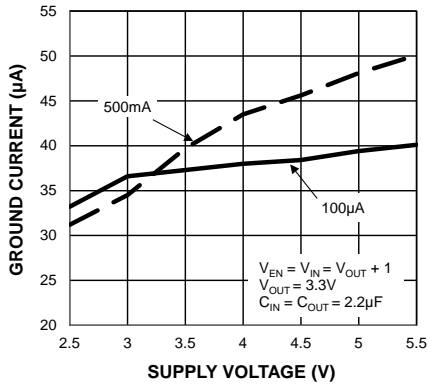

Ground Current vs. Load Current

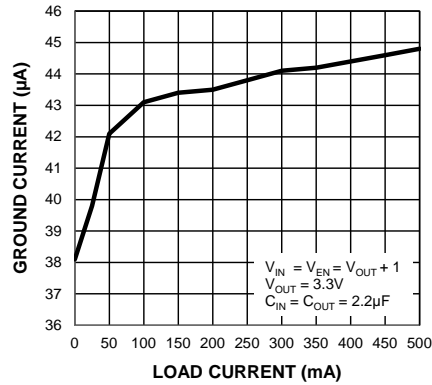

Ground Current vs. Temperature

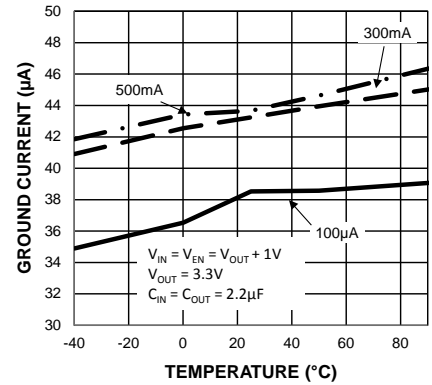

Output Voltage vs. Output Current

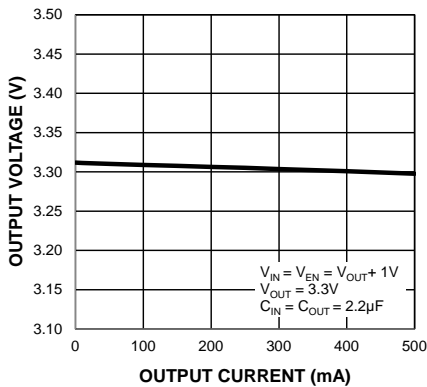

Output Voltage vs. Supply Voltage

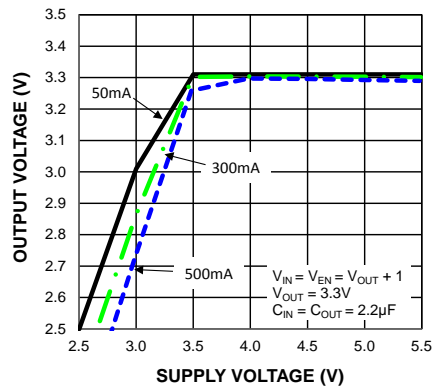

Output Voltage vs. Temperature

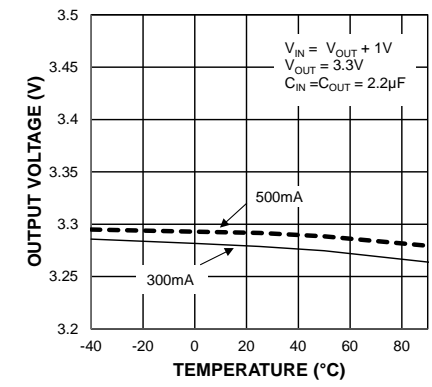

Typical Characteristics (Continued)

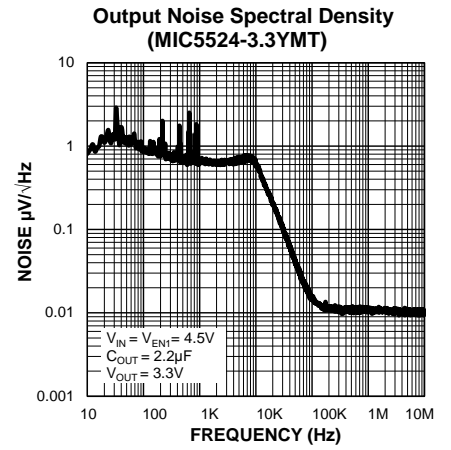
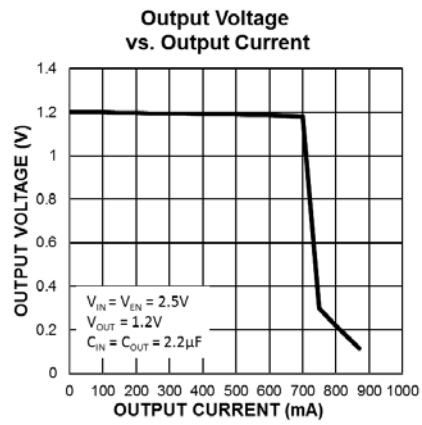
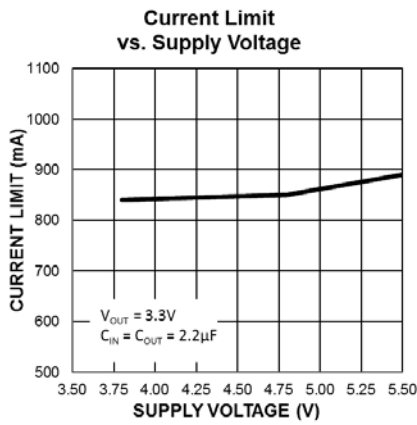

Functional Characteristics

Enable Turn-On

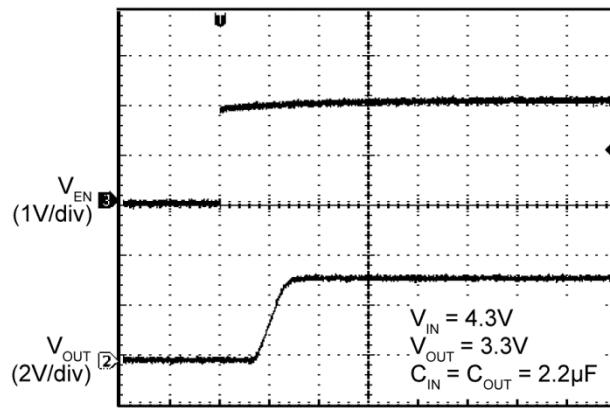

Time (40 μs /div)

Auto-Discharge (No Load)

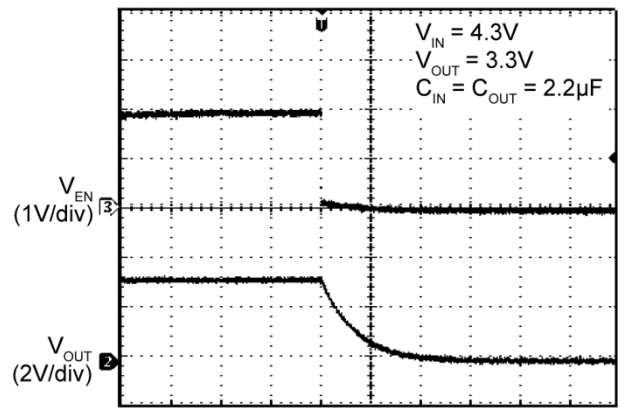

Time (100 μs /div)

Line Transient

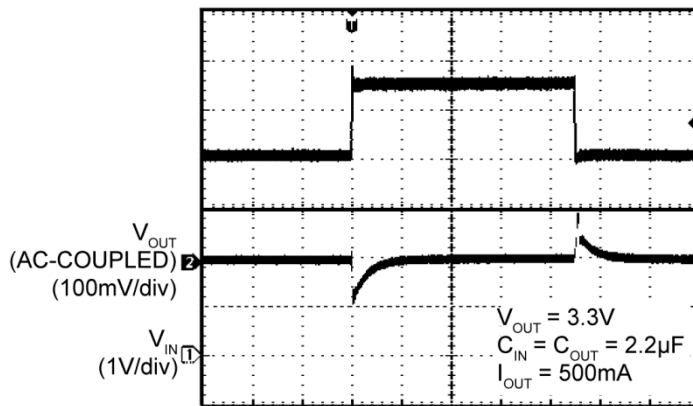

Time (20 μs /div)

Load Transient

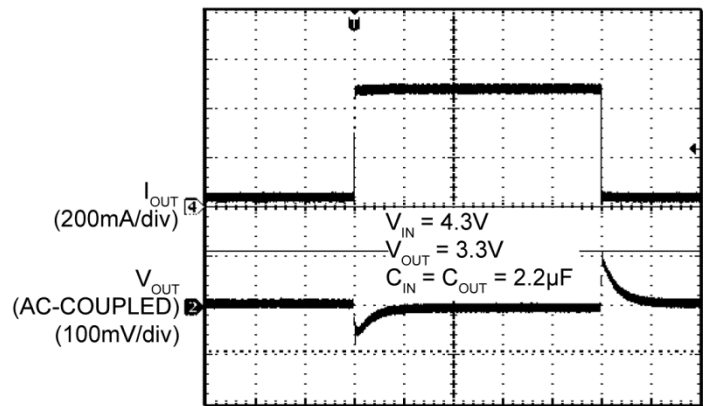

Time (20 μs /div)

Functional Block Diagram

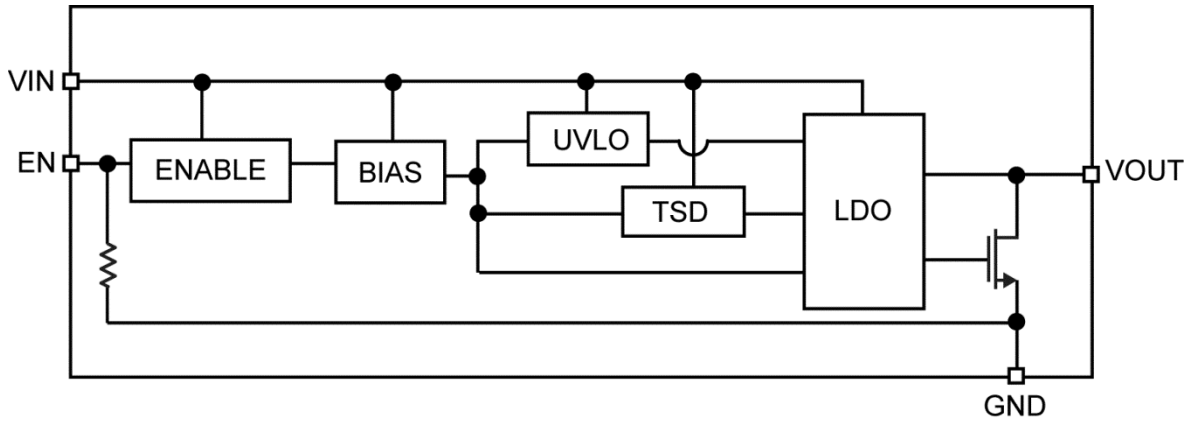

Application Information

The MIC5524 is a high-performance, low-power 500mA LDO. The MIC5524 includes an auto-discharge circuit that is switched on when the regulator is disabled through the enable pin. The MIC5524 also offers an internal pulldown resistor on the enable pin to ensure the output is disabled if the control signal is tri-stated. The MIC5524 regulator is fully protected from damage due to fault conditions, offering linear current limiting and thermal shutdown.

Input Capacitor

The MIC5524 is a high-performance, high-bandwidth device. An input capacitor of 2.2 μ F is required from the input to ground to provide stability. Low-ESR ceramic capacitors provide optimal performance at a minimum of space. Additional high-frequency capacitors, such as small-valued NPO dielectric-type capacitors, help filter out high-frequency noise and are good practice in any RF-based circuit. X5R or X7R dielectrics are recommended for the input capacitor. Y5V dielectrics lose most of their capacitance over temperature and are therefore, not recommended.

Output Capacitor

The MIC5524 requires an output capacitor of 2.2 μ F or greater to maintain stability. The design is optimized for use with low-ESR ceramic chip capacitors. High-ESR capacitors are not recommended because they may cause high-frequency oscillation. The output capacitor can be increased, but performance has been optimized for a 2.2 μ F ceramic output capacitor and does not improve significantly with larger capacitance.

X7R/X5R dielectric-type ceramic capacitors are recommended because of their temperature performance. X7R-type capacitors change capacitance by 15% over their operating temperature range and are the most stable type of ceramic capacitors. Z5U and Y5V dielectric capacitors change value by as much as 50% and 60%, respectively, over their operating temperature ranges. To use a ceramic chip capacitor with Y5V dielectric, the value must be much higher than an X7R ceramic capacitor to ensure the same minimum capacitance over the equivalent operating temperature range.

No-Load Stability

Unlike many other voltage regulators, the MIC5524 remains stable and in regulation with no load. This is especially important in CMOS RAM keep-alive applications.

Enable/Shutdown

The MIC5524 comes with an active-high enable pin that allows the regulator to be disabled. Forcing the enable pin low disables the regulator and sends it into an off mode current state drawing virtually zero current. When disabled the MIC5524 switches an internal 25 Ω load on the regulator output to discharge the external capacitor.

Forcing the enable pin high enables the output voltage. The MIC5524 has an internal pull down resistor on the enable pin to disable the output when the enable pin is floating.

Thermal Considerations

The MIC5524 is designed to provide 500mA of continuous current in a very small package. Maximum ambient operating temperature can be calculated based on the output current and the voltage drop across the part. For example if the input voltage is 3.6V, the output voltage is 3.3V, and the output current = 500mA. The actual power dissipation of the regulator circuit can be determined using Equation 1:

$$P_D = (V_{IN} - V_{OUT})I_{OUT} + V_{IN} I_{GND} \quad \text{Eq. 1}$$

Because this device is CMOS and the ground current is typically <100 μ A over the load range, the power dissipation contributed by the ground current is <1% and can be ignored Equation 2:

$$\begin{aligned} P_D &= (3.6V - 3.3V) \times 500mA \\ P_D &= 0.150W \end{aligned} \quad \text{Eq. 2}$$

To determine the maximum ambient operating temperature of the package, use the junction-to-ambient thermal resistance of the device Equation 3:

$$P_{D(MAX)} = \left(\frac{T_{J(MAX)} - T_A}{\theta_{JA}} \right) \quad \text{Eq. 3}$$

$T_{J(MAX)} = 125^\circ\text{C}$, the maximum junction temperature of the die, θ_{JA} thermal resistance = 250 $^\circ\text{C}/\text{W}$ for the TDFN package.

Substituting P_D for $P_{D(MAX)}$ and solving for the ambient operating temperature will give the maximum operating conditions for the regulator circuit. The junction-to-ambient thermal resistance for the minimum footprint is $250^{\circ}\text{C}/\text{W}$.

The maximum power dissipation must not be exceeded for proper operation.

For example, when operating the MIC5524-3.3YMT at an input voltage of 3.6V and a 500mA load with a minimum footprint layout, the maximum ambient operating temperature T_A can be determined as in Equation 4:

$$\begin{aligned} 0.15\text{W} &= (125^{\circ}\text{C} - T_A) / (250^{\circ}\text{C}/\text{W}) \\ T_A &= 87.5^{\circ}\text{C} \end{aligned} \quad \text{Eq. 4}$$

Therefore, the maximum ambient operating temperature allowed in a 1mm x 1mm TDFN package is 99°C . For a full discussion of heat sinking and thermal effects on voltage regulators, refer to the "Regulator Thermals" section of *Micrel's Designing with Low-Dropout Voltage Regulators* handbook. This information can be found on Micrel's website at:

http://www.micrel.com/_PDF/other/LDOBk_ds.pdf

Typical Application Schematic

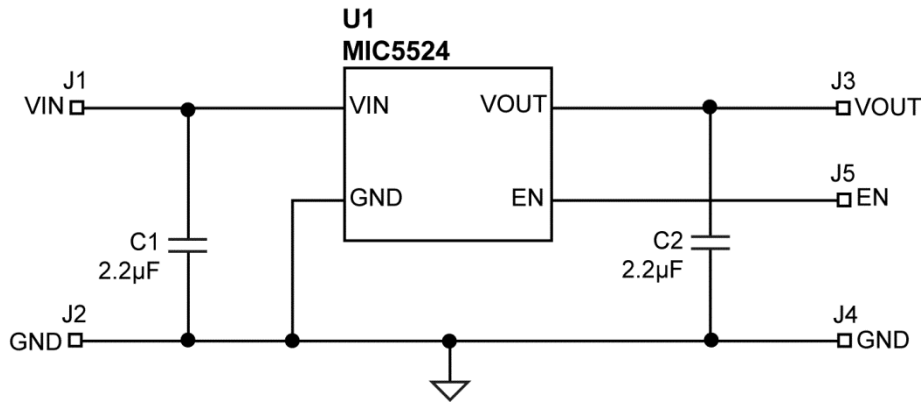

Bill of Materials

Item	Part Number	Manufacturer	Description	Qty.
C1, C2	GRM188R71A225KE15D	Murata ⁽¹²⁾	Capacitor, 2.2µF Ceramic, 10V, X5R, Size 0603	2
U1	MIC5524-x.xYMT	Micrel, Inc. ⁽¹³⁾	High-Performance 500mA LDO in Thin DFN Package	1

Notes:

- 12. Murata: www.murata.com.
- 13. Micrel, Inc.: www.micrel.com.

PCB Layout Recommendations

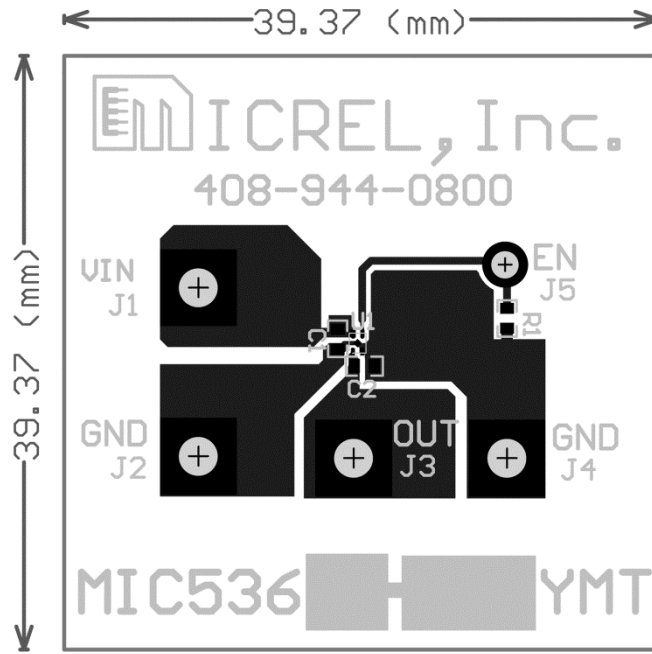

Top Layer

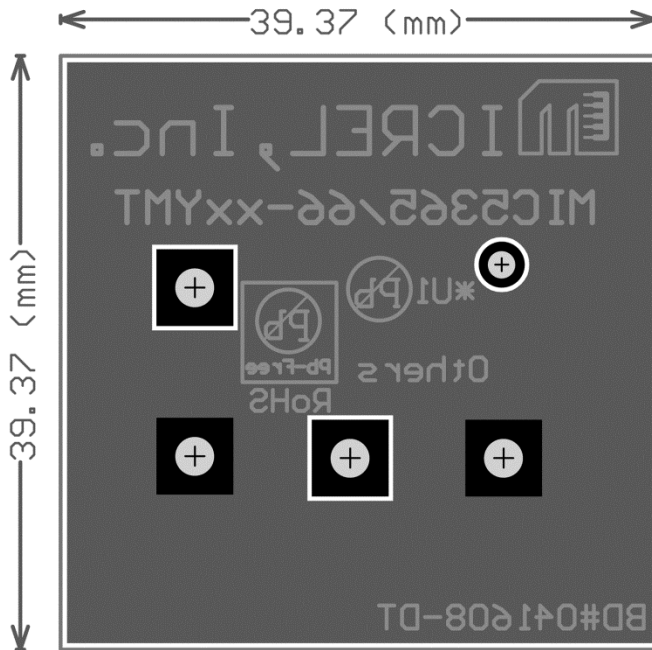

Bottom Layer

Package Information⁽¹⁴⁾ and Recommended Landing Pattern

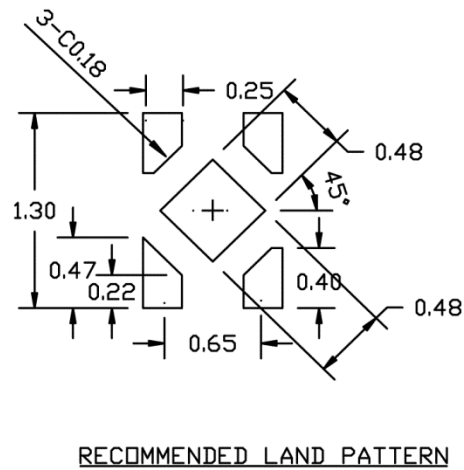
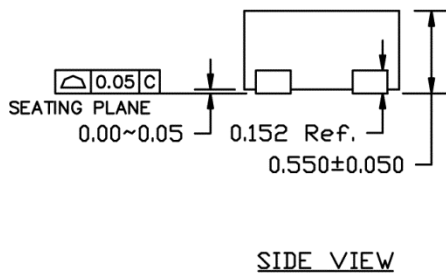
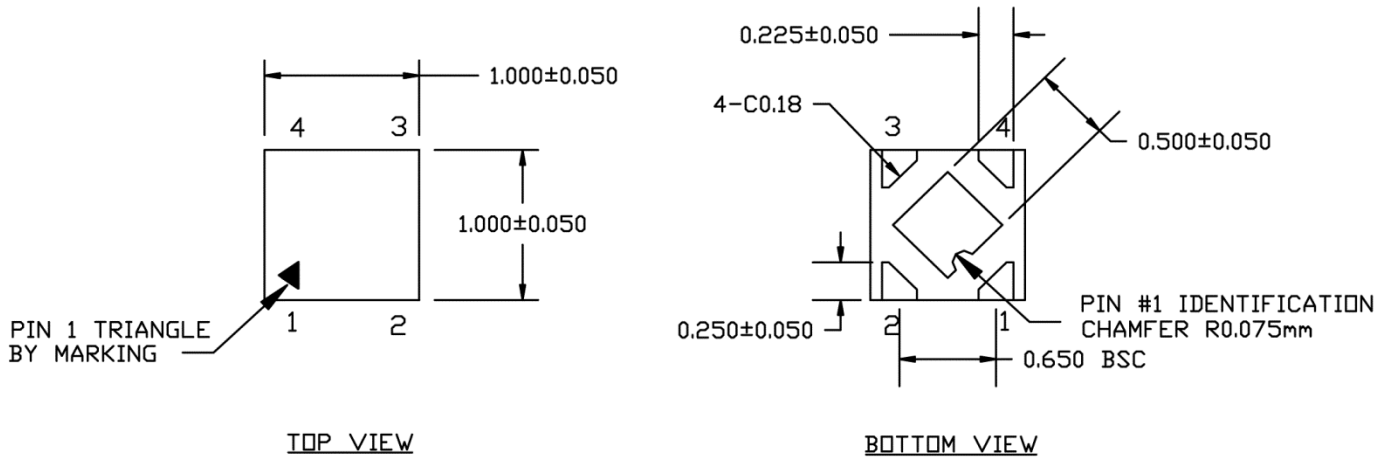

- NOTE:
1. MAX PACKAGE WARPAGE IS 0.05 MM
 2. MAX ALLOWABLE BURR IS 0.076MM IN ALL DIRECTIONS
 3. PIN #1 IS ON TOP WILL BE LASER MARKED
 4. UNSPECIFIED TOLERANCE IS +/- 0.05 MM

4-Pin 1mm x 1mm Thin DFN (MT)

Note:

14. Package information is correct as of the publication date. For updates and most current information, go to www.micrel.com.

MICREL, INC. 2180 FORTUNE DRIVE SAN JOSE, CA 95131 USATEL +1 (408) 944-0800 FAX +1 (408) 474-1000 WEB <http://www.micrel.com>

Micrel makes no representations or warranties with respect to the accuracy or completeness of the information furnished in this data sheet. This information is not intended as a warranty and Micrel does not assume responsibility for its use. Micrel reserves the right to change circuitry, specifications and descriptions at any time without notice. No license, whether express, implied, arising by estoppel or otherwise, to any intellectual property rights is granted by this document. Except as provided in Micrel's terms and conditions of sale for such products, Micrel assumes no liability whatsoever, and Micrel disclaims any express or implied warranty relating to the sale and/or use of Micrel products including liability or warranties relating to fitness for a particular purpose, merchantability, or infringement of any patent, copyright or other intellectual property right.

Micrel Products are not designed or authorized for use as components in life support appliances, devices or systems where malfunction of a product can reasonably be expected to result in personal injury. Life support devices or systems are devices or systems that (a) are intended for surgical implant into the body or (b) support or sustain life, and whose failure to perform can be reasonably expected to result in a significant injury to the user. A Purchaser's use or sale of Micrel Products for use in life support appliances, devices or systems is a Purchaser's own risk and Purchaser agrees to fully indemnify Micrel for any damages resulting from such use or sale.

© 2013 Micrel, Incorporated.

X-ON Electronics

Largest Supplier of Electrical and Electronic Components

Click to view similar products for [LDO Voltage Regulators](#) category:

Click to view products by [Microchip](#) manufacturer:

Other Similar products are found below :

[M38D29FFHP#U1](#) [702103A](#) [717726C](#) [742457H](#) [MP20051DN-LF-Z](#) [R5F111PGGFB#30](#) [AP7363-SP-13](#) [NCP103AMX285TCG](#)
[NCV8664CST33T3G](#) [NCV8752AMX28TCG](#) [L9454](#) [AP7362-HA-7](#) [LX13043CLD](#) [TCR3DF185,LM\(CT](#) [TCR3DF24,LM\(CT](#)
[TCR3DF285,LM\(CT](#) [TCR3DF31,LM\(CT](#) [TCR3DF45,LM\(CT](#) [TLF4949EJ](#) [MP2013GQ-33-Z](#) [L9708](#) [L970813TR](#) [030014BB](#) [059985X](#)
[NCP121AMX173TCG](#) [NCP4687DH15T1G](#) [701326R](#) [702087BB](#) [755078E](#) [TCR2EN28,LF\(S](#) [LM1117DT-1.8/NO](#) [LT1086CM#TRPBF](#)
[AZ1085S2-1.5TRE1](#) [MAX15101EWL+T](#) [NCV8170AXV250T2G](#) [TCR3DF27,LM\(CT](#) [TCR3DF19,LM\(CT](#) [TCR3DF125,LM\(CT](#)
[TCR2EN18,LF\(S](#) [MAX15103EWL+T](#) [TS2937CZ-5.0 C0](#) [MAX8878EUK30-T](#) [MAX663CPA](#) [NCV4269CPD50R2G](#) [NCV8716MT30TBG](#)
[AZ1117IH-1.2TRG1](#) [MP2013GQ-P](#) [AP2112R5A-3.3TRG1](#) [AP7315-25W5-7](#) [MAX15102EWL+T](#)