



## MIC69151/153

Single Supply  $V_{IN}$ , Low  $V_{IN}$ , Low  $V_{OUT}$ ,  
1.5A LDO

### General Description

The MIC69151/153 is the 1.5A output current member of the MIC69xxx family of high current, low voltage regulators, which support currents of 1A, 1.5A, 3A, and 5A. The MIC69151/153 operates from a single low voltage supply, yet offers high precision and ultra-low dropout of 500mV under worst case conditions.

The MIC69151/153 operates from an input voltage of 1.65V to 5.5V. It is designed to drive digital circuits requiring low voltage at high currents (i.e. PLDs, DSP, microcontroller, etc.). These regulators are available in adjustable and fixed output voltages including 1.8V. The adjustable version can support output voltages down to 0.5V.

The  $\mu$ Cap design of the MIC69151/153 is optimized for stability with low value low-ESR ceramic output capacitors.

Features of the MIC69151/153 include thermal shutdown and current limit protection. Logic enable and error flag pins are also available.

The MIC69151/153 is offered in a tiny 10-pin 3mm x 3mm MLF<sup>®</sup> package and an EPAD SOIC-8 package. Both packages have an operating temperature range of  $-40^{\circ}\text{C}$  to  $+125^{\circ}\text{C}$ .

Data sheets and support documentation can be found on Micrel's web site at: [www.micrel.com](http://www.micrel.com).

### Features

- Single input voltage range:  $V_{IN}$ : 1.65V to 5.5V
- Maximum dropout ( $V_{IN} - V_{OUT}$ ) of 500mV over temperature
- Adjustable output voltage down to 0.5V
- Stable with 10 $\mu\text{F}$  ceramic output capacitor
- Excellent line and load regulation specifications
- Logic controlled shutdown
- Thermal shutdown and current limit protection
- 10-Pin 3mm x 3mm MLF<sup>®</sup> package
- EPAD SOIC-8 package
- Available  $-40^{\circ}\text{C}$  to  $+125^{\circ}\text{C}$  junction temperature

### Applications

- Point-of-load applications
- Industrial power
- Sensitive RF applications

### Typical Application

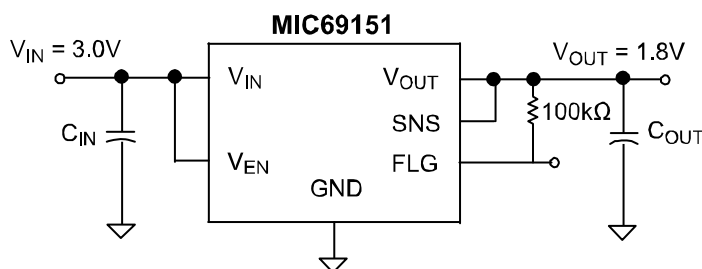

Fixed 1.8V Regulator w/Flag Error

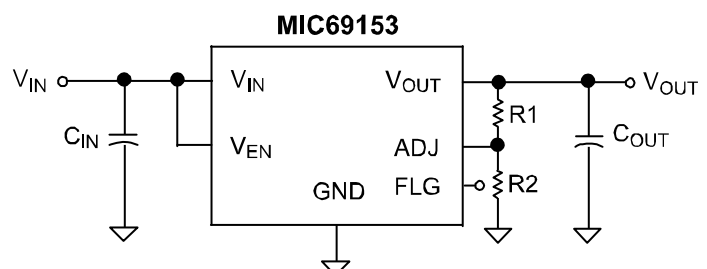

Adjustable Regulator

Super  $\beta$  PNP is a registered trademark of Micrel, Inc.

Micrel Inc. • 2180 Fortune Drive • San Jose, CA 95131 • USA • tel +1 (408) 944-0800 • fax + 1 (408) 474-1000 • <http://www.micrel.com>

## Ordering Information

Part Number	Nominal Output Voltage	Junction Temperature Range	Package	Lead Finish
MIC69151-1.8YML	1.8V	-40° to +125°C	10-Pin 3x3 MLF <sup>®</sup>	Pb-Free
MIC69151-1.8YME	1.8V	-40° to +125°C	8-Pin EPAD SOIC	Pb Free
MIC69153YME	Adj.	-40° to +125°C	8-Pin EPAD SOIC	Pb Free
MIC69153YML	Adj.	-40° to +125°C	10-Pin 3x3 MLF <sup>®</sup>	Pb-Free

## Pin Configuration

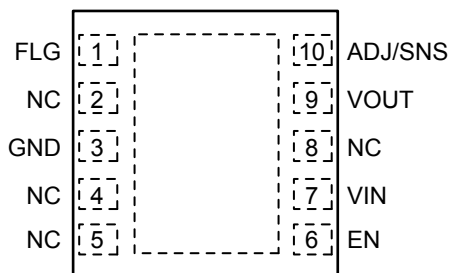

10-Pin 3mm x 3mm MLF<sup>®</sup> (ML)

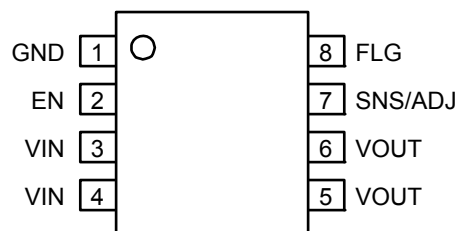

8-Pin EPAD SOIC (ME)

## Pin Description

Pin Number MLF-10	Pin Number EPAD SOIC-8	Pin Name	Pin Function
1	8	FLG	Error Flag (Output): Open collector output. Active low indicates an output fault condition.
2, 4, 5, 8	–	NC	Not internally connected.
3 (EP)	1	GND	Ground (exposed pad is recommended to connect to ground on MLF <sup>®</sup> ).
6	2	EN	Enable (Input): CMOS compatible input. Logic high = enable, logic low = shutdown. Do not leave pin floating.
7	3, 4	VIN	Input voltage which supplies current to the output power device.
9	5, 6	VOUT	Regulator Output.
10 (Adj)	7 (Adj)	ADJ	Adjustable regulator feedback input. Connect to resistor voltage divider.
10 (Fixed)	7 (Fixed)	SNS	Sense pin, connect to output for improved voltage regulation.

**Absolute Maximum Ratings<sup>(1)</sup>**

Supply Input Voltage ( $V_{IN}$ )	6V
Logic Input Voltage ( $V_{EN}$ , $V_{LQ}$ )	0V to $V_{IN}$
Power Dissipation ( $P_D$ )	Internally Limited <sup>(3)</sup>
Flag	6V
Storage Temperature ( $T_S$ )	-65°C to +125°C
ESD <sup>(4)</sup>	2kV

**Operating Ratings<sup>(2)</sup>**

Supply Voltage ( $V_{IN}$ )	1.65V to 5.5V
Enable Input Voltage ( $V_{EN}$ )	0V to $V_{IN}$
Junction Temperature ( $T_J$ )	-40°C ≤ $T_J$ ≤ +125°C
Package Thermal Resistance	
3x3 MLF <sup>®</sup> ( $\theta_{JA}$ )	60°C/W
EPAD SOIC-8 ( $\theta_{JA}$ )	41°C/W

**Electrical Characteristics<sup>(4)</sup>**

$T_A = 25^\circ\text{C}$  with  $V_{IN} = V_{OUT} + 1\text{V}$ ; **bold** values indicate  $-40^\circ\text{C} \leq T_J \leq +125^\circ\text{C}$ ;  $I_{OUT} = 10\text{mA}$ ;  $C_{OUT}$  4.7 $\mu\text{F}$  ceramic, unless otherwise noted.

Parameter	Conditions	Min	Typ	Max	Units
Output Voltage Accuracy (Fixed)	Over temperature range	-2		+2	%
Adjustable Feedback Voltage (Adj)		0.49	0.5	0.51	V
Feedback Pin Current			0.25	1	$\mu\text{A}$
Output Voltage Line Regulation (Note 5)	$V_{IN} = V_{OUT} + 1.0\text{V}$ to 5.5V For $V_{OUT} \geq 0.65\text{V}$ , $V_{IN} = 1.65$ to 5.5V		±0.2	±0.3	%/V
Output Voltage Load Regulation	$I_L = 10\text{mA}$ to 1.5A		±0.2		%
$V_{IN} - V_O$ ; Dropout Voltage (Note 6)	$I_L = 1.0\text{A}$		185	300	mV
	$I_L = 1.5\text{A}$		250	500	mV
Ground Pin Current	$I_L = 10\text{mA}$		1.6		mA
	$I_L = 0.5\text{A}$		7.5	20	mA
	$I_L = 1.5\text{A}$		20	35	mA
Ground Pin Current in Shutdown	$V_{EN} = 0\text{V}$		1		$\mu\text{A}$
Current Limit	$V_{OUT} = 0\text{V}$	1.7	2.6		A
Start-up Time	$V_{EN} = V_{IN}$		10	150	$\mu\text{s}$
Thermal Shutdown			165		°C
<b>Enable Input</b>					
Enable Input Threshold	Regulator enable	0.8	0.6		V
	Regulator shutdown			0.2	V
Enable Pin Input Current	$V_{IL} \leq 0.2\text{V}$ (Regulator shutdown)		0.005		$\mu\text{A}$
	$V_{IH} \geq 0.8\text{V}$ (Regulator enable)		7		$\mu\text{A}$
<b>Flag Output</b>					
$I_{FLG(LEAK)}$	Flag Output Leakage Current (Flag Off)		0.05		$\mu\text{A}$
$V_{FLG(LO)}$	Output Logic-Low Voltage (undervoltage condition), $I_L = 5\text{mA}$		150		mV
$V_{FLG}$	Threshold, % of $V_{OUT}$ below nominal (falling)	7.5	10	14	%
	Hysteresis		2		%

**Notes:**

- Exceeding the absolute maximum rating may damage the device.
- The device is not guaranteed to function outside its operating rating.
- The maximum allowable power dissipation of any  $T_A$  (ambient temperature) is  $(P_{D(max)} = T_{J(max)} - T_A) / \theta_{JA}$ . Exceeding the maximum allowable power dissipation will result in excessive die temperature and the regulator will go into thermal shutdown.
- Specification for packaged product only.
- Minimum input for line regulation test is set to  $V_{OUT} + 1\text{V}$  relative to the highest output voltage.
- Dropout voltage is defined as the input-to-output differential at which the output voltage drops 2% below its nominal value measured at 1V differential. For outputs below 1.65V, dropout voltage is considered the input-to-output voltage differential with the minimum input voltage of 1.65V. Minimum input operating voltage is 1.65V.

# Typical Characteristics

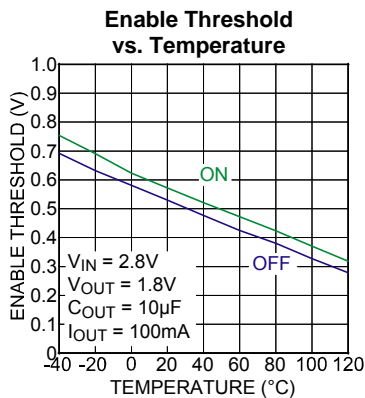
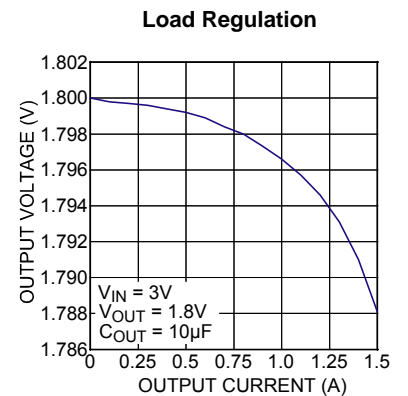
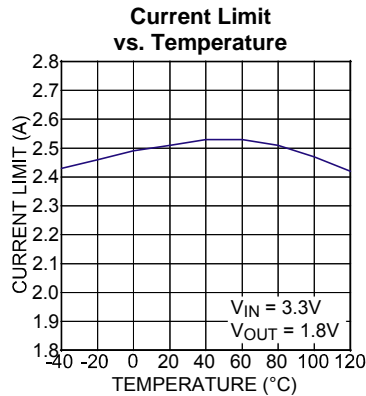
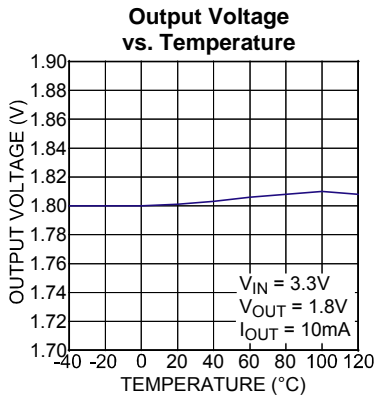
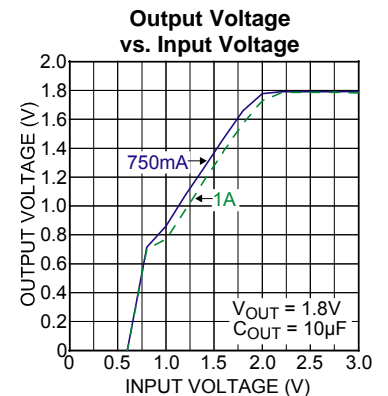
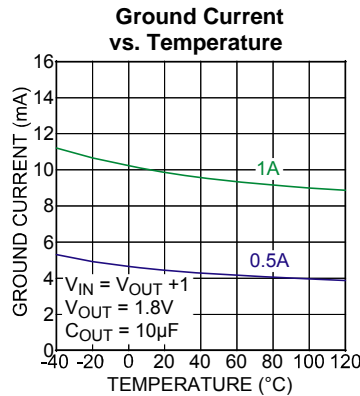
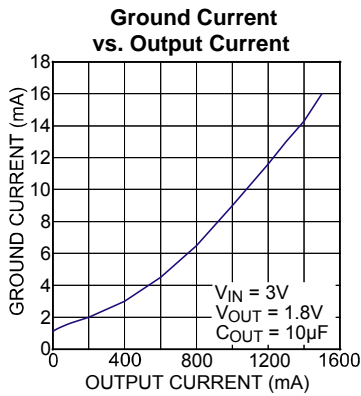
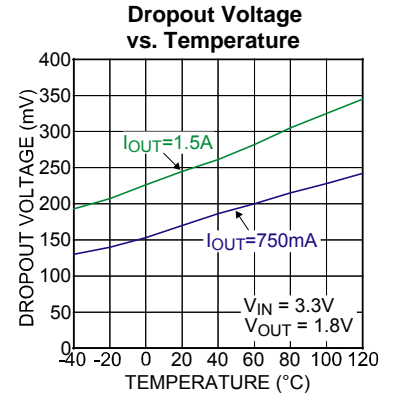
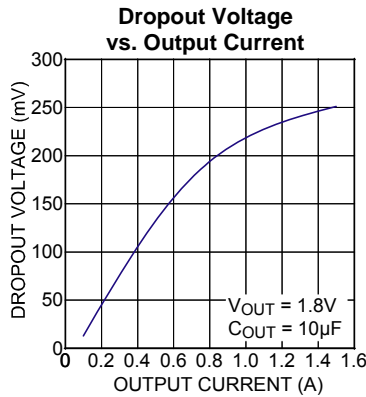
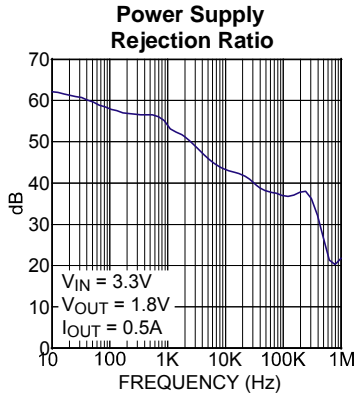

## Functional Characteristics

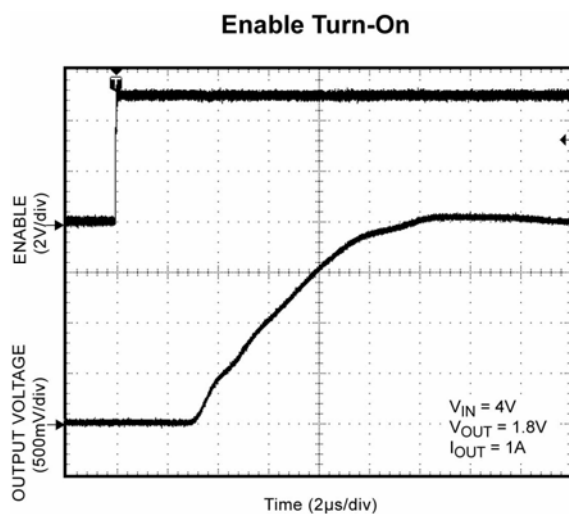
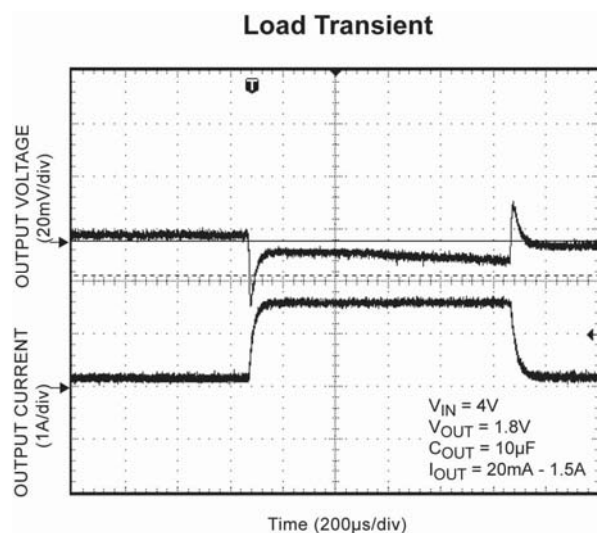
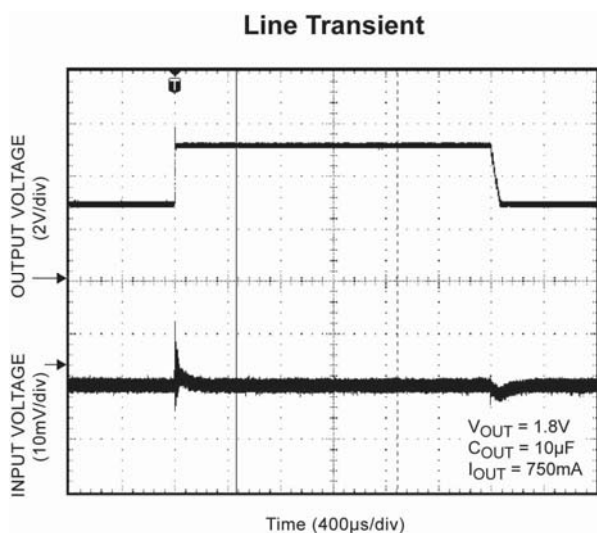

### Functional Diagram

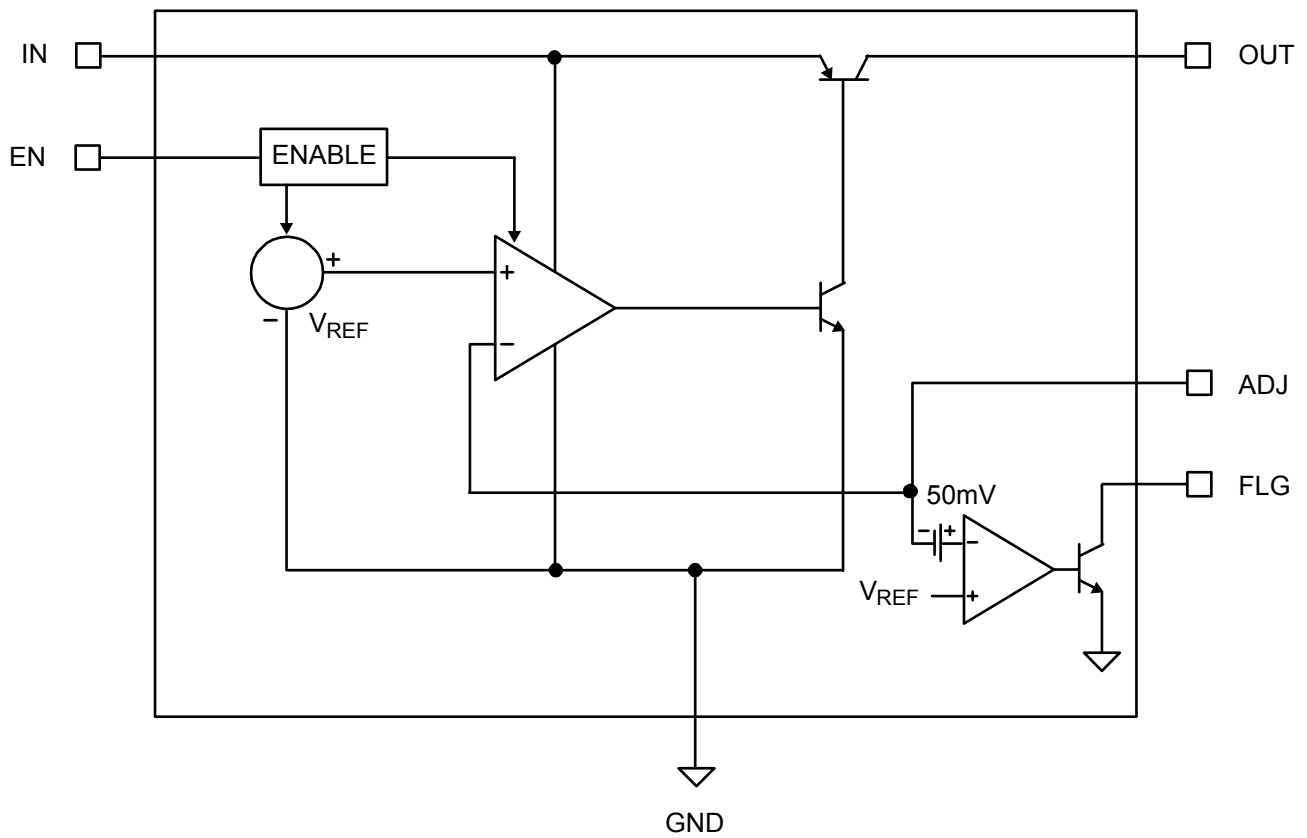

## Application Information

The MIC69151/153 is an ultra-high performance low dropout linear regulator designed for high current applications requiring a fast transient response. It utilizes a single input supply, perfect for low-voltage DC-to-DC conversion. The MIC69151/153 requires a minimum number of external components.

The MIC69151/153 regulator is fully protected from damage due to fault conditions offering constant current limiting and thermal shutdown.

### Input Supply Voltage

$V_{IN}$  provides high current to the collector of the pass transistor. The minimum input voltage is 1.65V allowing conversion from low voltage supplies.

### Output Capacitor

The MIC69151/153 requires a minimum of output capacitance to maintain stability. However, proper capacitor selection is important to ensure desired transient response. The MIC69151/153 is specifically designed to be stable with low ESR ceramic chip capacitors. A 10 $\mu$ F ceramic chip capacitor should satisfy most applications. Output capacitor can be increased without bound. See typical characteristics for examples of load transient response.

X7R dielectric ceramic capacitors are recommended because of their temperature performance. X7R-type capacitors change capacitance by only 15% over their operating temperature range and are the most stable type of ceramic capacitors. Z5U and Y5V dielectric capacitors change value by as much as 50% and 60%, respectively over their operating temperature ranges. To use a ceramic chip capacitor with Y5V dielectric the value must be much higher than an X7R ceramic or a tantalum capacitor to ensure the same capacitance value over the operating temperature range. Tantalum capacitors have a very stable dielectric (10% over their operating temperature range) and can also be used with this device.

### Input Capacitor

An input capacitor of 1 $\mu$ F or greater is recommended when the device is more than 4 inches away from the bulk supply capacitance or when the supply is a battery. Small, surface mount, ceramic chip capacitors can be used for the bypassing. The capacitor should be placed within 1 inch of the device for optimal performance. Larger values will help to improve ripple rejection by bypassing the input to the regulator further improving the integrity of the output voltage.

### Minimum Load Current

The MIC69151/153 regulator is specified between finite loads. If the output current is too small, leakage currents dominate and the output voltage rises. A 10mA minimum load current is necessary for proper operation.

### Adjustable Regulator Design

The MIC69153 adjustable version allows programming the output voltage anywhere between 0.5V and 5.5V with two resistors. The resistor value between  $V_{OUT}$  and the adjust pin should not exceed 10k $\Omega$ . Larger values can cause instability. The resistor values are calculated by:

$$V_{OUT} = 0.5 * \left( \frac{R_1}{R_2} + 1 \right)$$

Where  $V_{OUT}$  is the desired output voltage.

### Enable

The fixed output voltage versions of the MIC69151 feature an active high enable input (EN) that allows on-off control of the regulator. Current drain reduces to near “zero” when the device is shutdown, with only microamperes of leakage current. EN may be directly tied to  $V_{IN}$  and pulled up to the maximum supply voltage.

### Thermal Design

Linear regulators are simple to use. The most complicated design parameters to consider are thermal characteristics. Thermal design requires the following application-specific parameters:

- Maximum ambient temperature ( $T_A$ )
- Output current ( $I_{OUT}$ )
- Output voltage ( $V_{OUT}$ )
- Input voltage ( $V_{IN}$ )
- Ground current ( $I_{GND}$ )

First, calculate the power dissipation of the regulator from these numbers and the device parameters from this data sheet.

$$P_D = (V_{IN} - V_{OUT}) I_{OUT} + V_{IN} I_{GND}$$

where the ground current is approximated by using numbers from the “Electrical Characteristics” or “Typical Characteristics” sections. The maximum allowable power dissipation of any  $T_A$  (ambient temperature) is  $P_{D(max)} = (T_{J(max)} - T_A) / \theta_{JA}$ . Exceeding the maximum allowable power dissipation will result in excessive die temperature and the regulator will go into thermal shutdown.

Refer to “Application Note 9” for further details and examples on thermal design and heat sink applications.

# Package Information

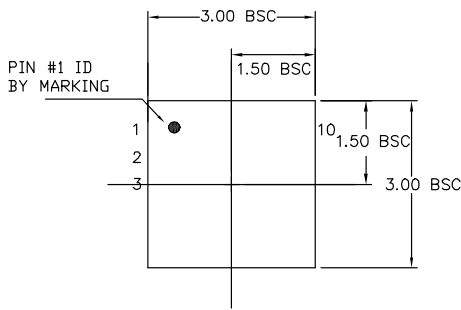

TOP VIEW

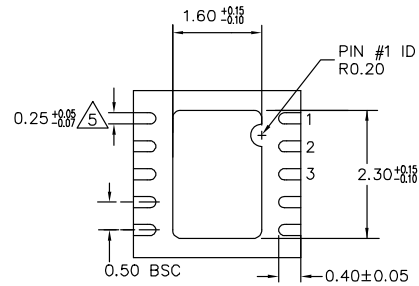

BOTTOM VIEW

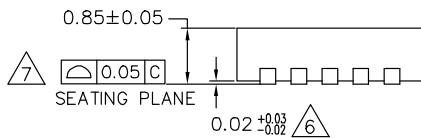

SIDE VIEW

- NOTE:
1. ALL DIMENSIONS ARE IN MILLIMETERS.
  2. MAX. PACKAGE WARPAGE IS 0.05 mm.
  3. MAXIMUM ALLOWABLE BURRS IS 0.076 mm IN ALL DIRECTIONS.
  4. PIN #1 ID ON TOP WILL BE LASER/INK MARKED.
- ① DIMENSION APPLIES TO METALIZED TERMINAL AND IS MEASURED BETWEEN 0.20 AND 0.25 mm FROM TERMINAL TIP.
- ② APPLIED ONLY FOR TERMINALS.
- ③ APPLIED FOR EXPOSED PAD AND TERMINALS.

## 10-Pin 3mm x 3mm MLF® (ML)

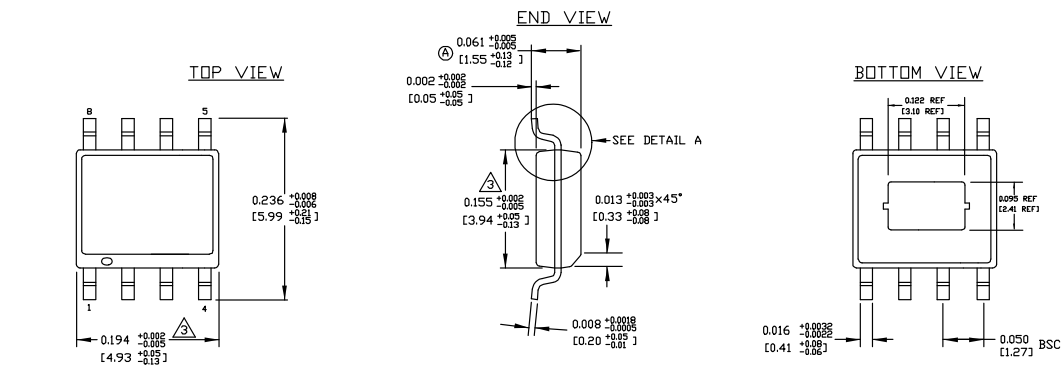

- NOTES:
1. DIMENSIONS ARE IN INCHES[MM].
  2. CONTROLLING DIMENSION: INCHES.
  3. DIMENSION DOES NOT INCLUDE MOLD FLASH OR PROTRUSIONS, EITHER OF WHICH SHALL NOT EXCEED 0.006[0.15] PER SIDE.

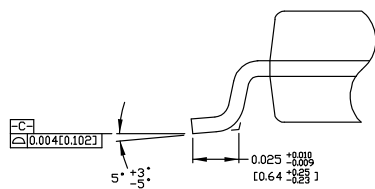

DETAIL "A"

## 8-Pin EPAD SOIC (ME)



---

**MICREL, INC. 2180 FORTUNE DRIVE SAN JOSE, CA 95131 USA**  
TEL +1 (408) 944-0800 FAX +1 (408) 474-1000 WEB <http://www.micrel.com>

The information furnished by Micrel in this data sheet is believed to be accurate and reliable. However, no responsibility is assumed by Micrel for its use. Micrel reserves the right to change circuitry and specifications at any time without notification to the customer.

Micrel Products are not designed or authorized for use as components in life support appliances, devices or systems where malfunction of a product can reasonably be expected to result in personal injury. Life support devices or systems are devices or systems that (a) are intended for surgical implant into the body or (b) support or sustain life, and whose failure to perform can be reasonably expected to result in a significant injury to the user. A Purchaser's use or sale of Micrel Products for use in life support appliances, devices or systems is a Purchaser's own risk and Purchaser agrees to fully indemnify Micrel for any damages resulting from such use or sale.

© 2008 Micrel, Incorporated.

## X-ON Electronics

Largest Supplier of Electrical and Electronic Components

*Click to view similar products for [LDO Voltage Regulators](#) category:*

*Click to view products by [Microchip](#) manufacturer:*

Other Similar products are found below :

[M38D29FFHP#U1](#) [702103A](#) [717726C](#) [742457H](#) [MP20051DN-LF-Z](#) [R5F111PGGFB#30](#) [AP7363-SP-13](#) [NCP103AMX285TCG](#)  
[NCV8664CST33T3G](#) [NCV8752AMX28TCG](#) [L9454](#) [AP7362-HA-7](#) [LX13043CLD](#) [TCR3DF185,LM\(CT](#) [TCR3DF24,LM\(CT](#)  
[TCR3DF285,LM\(CT](#) [TCR3DF31,LM\(CT](#) [TCR3DF45,LM\(CT](#) [TLF4949EJ](#) [MP2013GQ-33-Z](#) [L9708](#) [L970813TR](#) [030014BB](#) [059985X](#)  
[EAN61387601](#) [EAN61573601](#) [NCP121AMX173TCG](#) [NCP4687DH15T1G](#) [NCV8703MX30TCG](#) [701326R](#) [702087BB](#) [755078E](#)  
[TCR2EN28,LF\(S](#) [LM1117DT-1.8/NO](#) [LT1086CM#TRPBF](#) [AZ1085S2-1.5TRE1](#) [MAX15101EWL+T](#) [NCV8170AXV250T2G](#)  
[TCR3DF27,LM\(CT](#) [TCR3DF19,LM\(CT](#) [TCR3DF125,LM\(CT](#) [TCR2EN18,LF\(S](#) [MAX15103EWL+T](#) [TS2937CZ-5.0 C0](#) [MAX8878EUK30-](#)  
[T](#) [MAX663CPA](#) [NCV4269CPD50R2G](#) [NCV8716MT30TBG](#) [AZ1117IH-1.2TRG1](#) [MP2013GQ-P](#)