



MIC69502

5A, Low V_{IN} , Low V_{OUT} μ Cap LDO Regulator

General Description

The MIC69502 is a 5A, low dropout linear regulator that provides low voltage high current outputs with a minimum of external components. It offers high precision and ultra low dropout of 500mV under worst case conditions.

The MIC69502 operates from an input voltage of 1.65V to 5.5V. It is designed to drive digital circuits requiring low voltage at high currents (i.e. PLDs, DSP, microcontroller, etc.). The MIC69502 output is adjustable to a minimum of 0.5V.

The μ Cap design of the MIC69502 is optimized for stability with low value low-ESR ceramic output capacitors.

Protection features of the MIC69502 include thermal shutdown and current limit protection. Logic enable and error flag pins are also available.

The MIC69502 is offered in the space-efficient S-PAK package. It has an operating temperature range of -40°C to $+125^{\circ}\text{C}$.

Data sheets and support documentation can be found on Micrel's web site at: www.micrel.com.

Features

- Input voltage range: V_{IN} : 1.65V to 5.5V
- $\pm 1.0\%$ initial output tolerance
- Maximum dropout ($V_{IN} - V_{OUT}$) of 500mV over temperature
- Adjustable output voltage down to 0.5V
- Stable with $10\mu\text{F}$ ceramic output capacitor (5A)
- Excellent line and load regulation specifications
- Logic controlled shutdown
- Thermal shutdown and current limit protection
- 7-Pin S-Pak package
- -40°C to $+125^{\circ}\text{C}$ Temperature Junction

Applications

- ASIC Core Voltage Regulator
- PLD/FPGA Core Power Supply
- Linear Point-of-Load Conversion
- High-Speed Post-Regulator

Typical Application

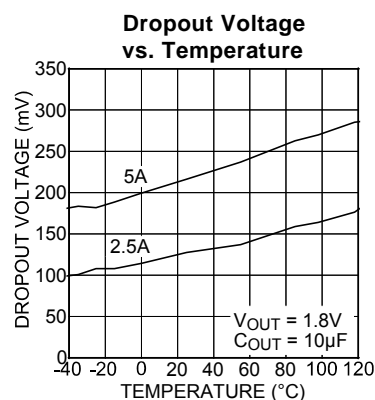
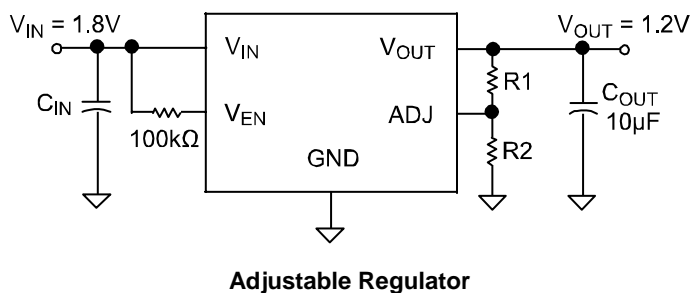

Ordering Information

Part Number*	Output Current	Output Voltage**	Junction Temperature Range	Package
MIC69502WR	5A	Adj.	-40° to +125°C	7-Pin S-PAK

Note:

* RoHS compliant with 'high-melting solder' exemption.

** For fixed voltages available, please contact Micrel marketing for details.

Pin Configuration

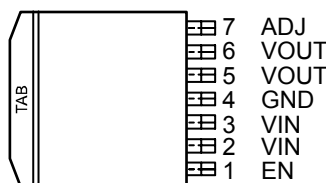

7-Pin S-PAK (R)

Pin Description

Pin Number	Pin Name	Pin Function
1	EN	Enable (Input): CMOS compatible input. Logic high = enable, logic low = shutdown. Do not float.
2, 3	VIN	Input voltage which supplies current to the output power device.
4	GND	Ground (TAB is connected to ground on S-Pak).
5, 6	VOUT	Regulator Output.
7	ADJ	Adjustable regulator feedback input. Connect to resistor voltage divider. Applies only to adjustable output voltage parts.

Absolute Maximum Ratings⁽¹⁾

Supply Input Voltage (V_{IN}).....	+6.0V
Enable Input Voltage (V_{EN}).....	V_{IN}
Power Dissipation (P_D).....	Internally Limited ⁽³⁾
Junction Temperature (T_J)	$-40^{\circ}\text{C} \leq T_J \leq +125^{\circ}\text{C}$

Operating Ratings⁽²⁾

Supply Voltage (V_{IN}).....	+1.65V to +5.5V
Enable Input Voltage (V_{EN}).....	0V to V_{IN}
Junction Temperature (T_J)	$-40^{\circ}\text{C} \leq T_J \leq +125^{\circ}\text{C}$
Package Thermal Resistance S-PAK-7 (θ_{JC}).....	2°C/W

Electrical Characteristics⁽⁴⁾

$T_A = 25^{\circ}\text{C}$ with $V_{IN} = V_{OUT} + 1\text{V}$; **bold** values indicate $-40^{\circ}\text{C} \leq T_J \leq +125^{\circ}\text{C}$; $I_{OUT} = 10\text{mA}$, unless noted.

Parameter	Conditions	Min	Typ	Max	Units
Output Voltage Accuracy	At 25°C	-1		+1	%
	Over temperature range	-2		+2	%
Output Voltage Line Regulation (Note 5)	$V_{IN} = V_{OUT} + 1.0\text{V}$ to 5.5V		0.2	0.5	%
Output Voltage Load Regulation	$I_L = 10\text{mA}$ to 5A		0.2		%
$V_{IN} - V_O$; Dropout Voltage (Note 6)	$I_L = 2.5\text{A}$		160	300	mV
	$I_L = 5.0\text{A}$		250	500	mV
Ground Pin Current	$I_L = 10\text{mA}$		1	5	mA
	$I_L = 500\text{mA}$		3	10	mA
	$I_L = 2.5\text{A}$		20	50	mA
	$I_L = 5.0\text{A}$		54	150	mA
Ground Pin Current in Shutdown	$V_{EN} = 0\text{V}$		5	10	μA
Current Limit		5.5	10		A
Start-up Time	$V_{EN} = V_{IN}$		50	150	μs
Enable Input					
Enable Input Threshold	Regulator enable	0.8	0.6		V
	Regulator shutdown			0.2	V
Enable Pin Input Current	$V_{IN} \leq 0.2\text{V}$ (Regulator shutdown)		1		μA
	$V_{IN} \leq 0.8\text{V}$ (Regulator enable)		100		μA

Notes:

- Exceeding the absolute maximum rating may damage the device.
- The device is not guaranteed to function outside its operating rating.
- The maximum allowable power dissipation of any T_A (ambient temperature) is $(P_{D(max)} = T_{J(max)} - T_A) / \theta_{JA}$. Exceeding the maximum allowable power dissipation will result in excessive die temperature and the regulator will go into thermal shutdown.
- Specification for packaged product only.
- Minimum input for line regulation test is set to $V_{OUT} + 1\text{V}$ relative to the highest output voltage.
- Dropout voltage is defined as the input-to-output differential at which the output voltage drops 2% below its nominal value measured at 1V differential. For outputs below 1.65V, dropout voltage is considered the input-to-output voltage differential with the minimum input voltage of 1.65V. Minimum input operating voltage is 1.65V.

Typical Characteristics

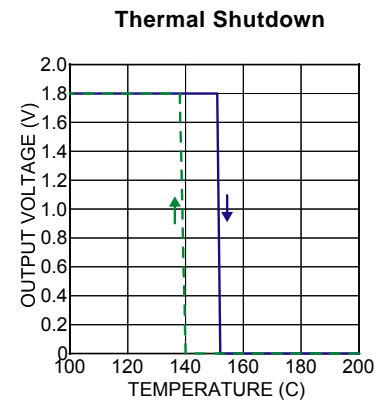
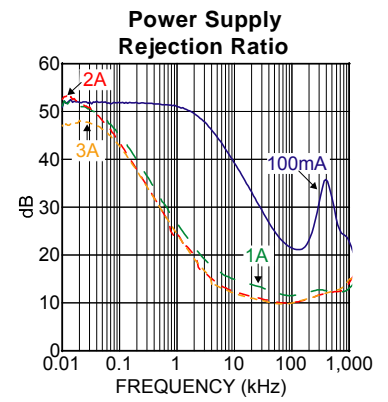
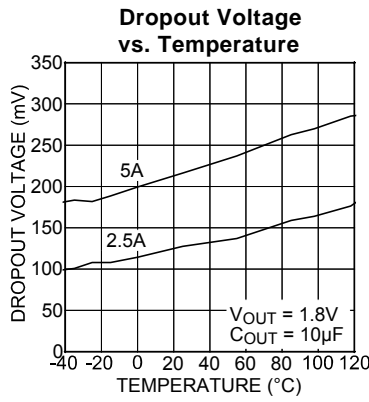
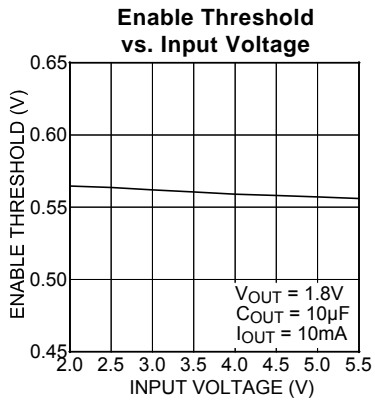
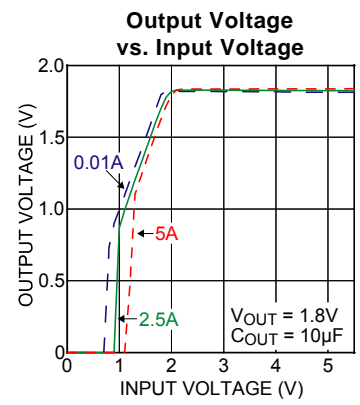
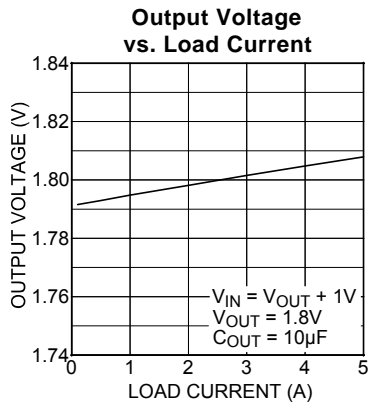
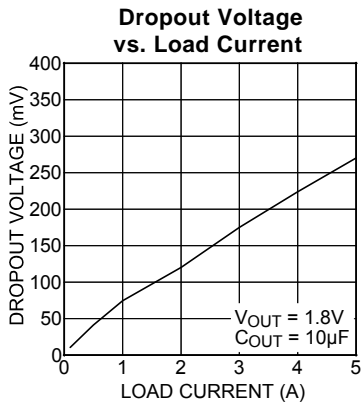
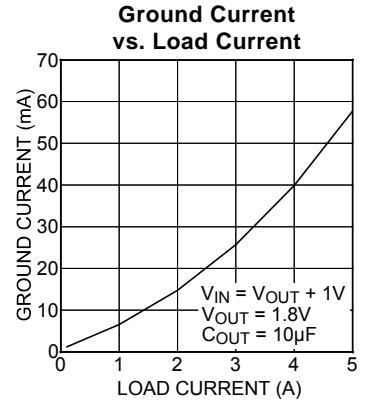
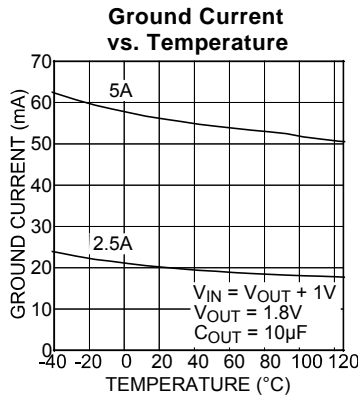
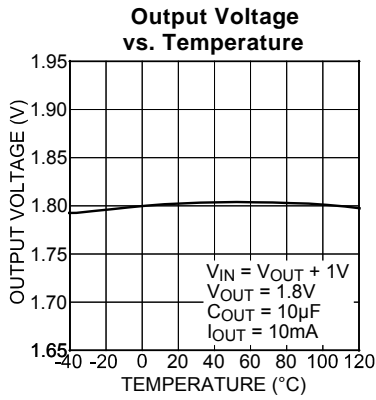

Functional Characteristics

Enable

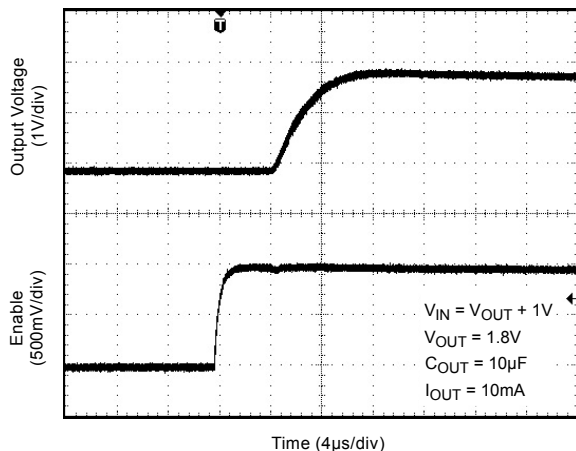

Line Transient

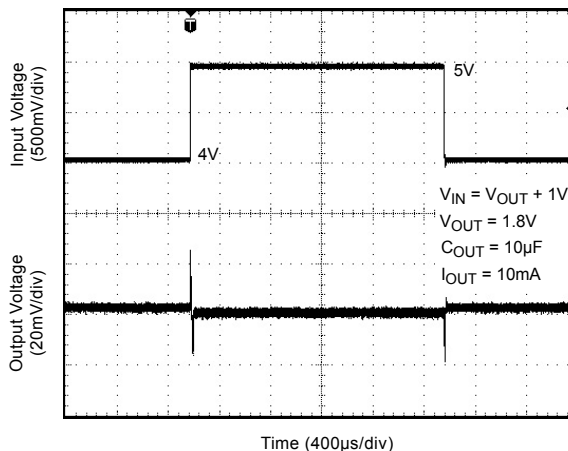

Load Transient

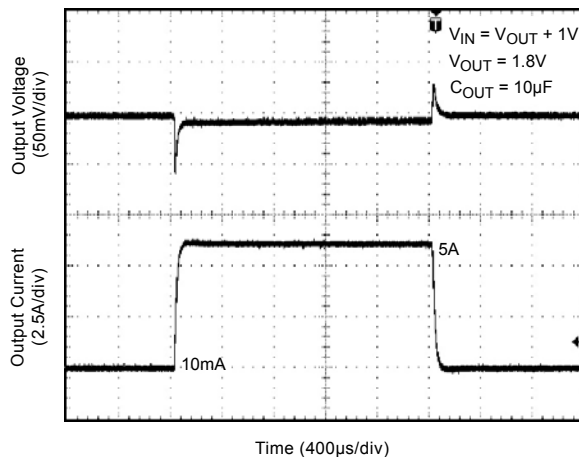

Functional Diagram

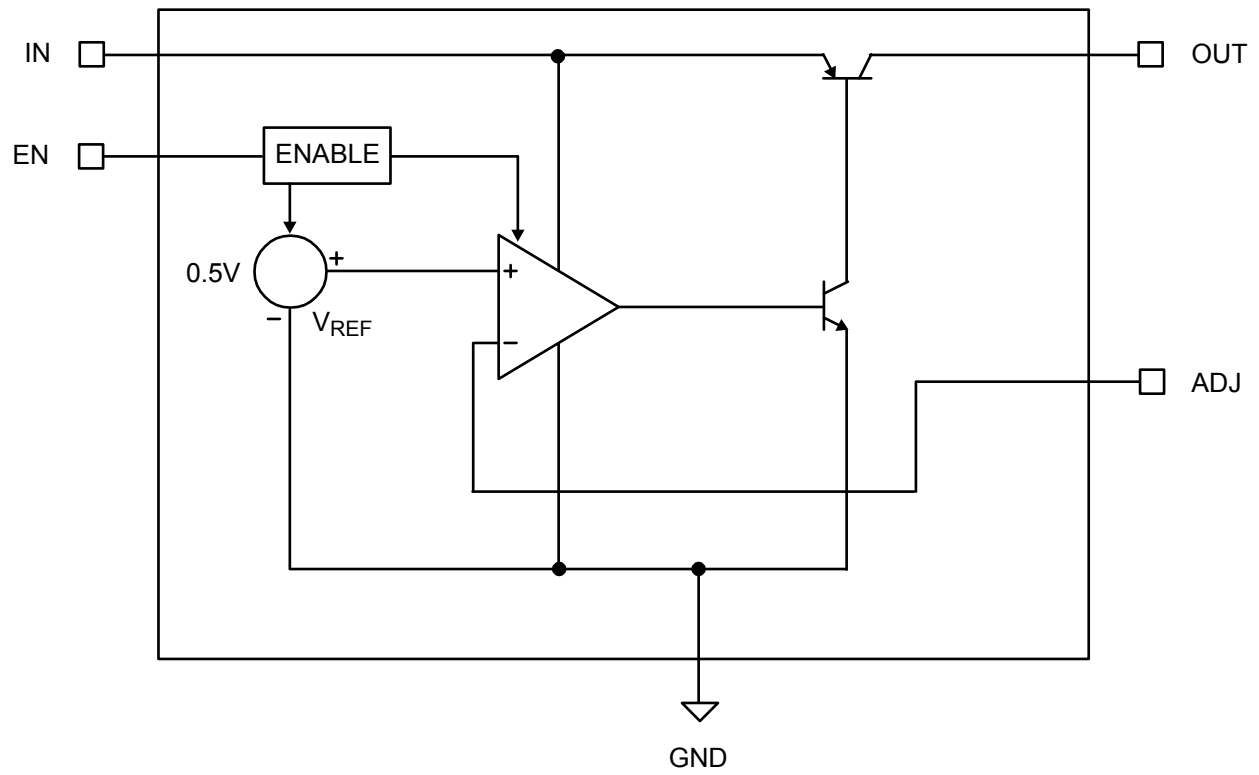

Application Information

The MIC69502 is an ultra-high performance low dropout linear regulator designed for high current applications requiring fast transient response. It utilizes a single input supply and has very low dropout voltage perfect for low-voltage DC-to-DC conversion. The MIC69502 requires a minimum of external components. As a μ Cap regulator the output is tolerant of virtually any type of capacitor including ceramic and tantalum.

The MIC69502 regulator is fully protected from damage due to fault conditions offering constant current limiting and thermal shutdown.

Input Supply Voltage

V_{IN} provides high current to the collector of the pass transistor. The minimum input voltage is 1.65V allowing conversion from low voltage supplies.

Output Capacitor

The MIC69502 requires a minimum of output capacitance to maintain stability. However, proper capacitor selection is important to ensure desired transient response. The MIC69502 is specifically designed to be stable with a wide range of capacitance values and ESR. A 10 μ F ceramic chip capacitor should satisfy most applications. See typical characteristics for examples of load transient response.

X7R dielectric ceramic capacitors are recommended because of their temperature performance. X7R-type capacitors change capacitance by only 15% over their operating temperature range and are the most stable type of ceramic capacitors. Z5U and Y5V dielectric capacitors change value by as much as 50% and 60%, respectively over their operating temperature ranges. To use a ceramic chip capacitor with Y5V dielectric the value must be much higher than an X7R ceramic or a tantalum capacitor to ensure the same capacitance value over the operating temperature range. Tantalum capacitors have a very stable dielectric (10% over their operating temperature range) and can also be used with this device.

Input Capacitor

An input capacitor of 1 μ F or greater is recommended when the device is more than 4 inches away from the bulk supply capacitance or when the supply is a battery. Small, surface mount, ceramic chip capacitors can be used for the bypassing. The capacitor should be placed within 1" of the device for optimal performance. Larger values will help to improve ripple rejection by bypassing the input to the regulator further improving the integrity of the output voltage.

Minimum Load Current

The MIC69502 regulator is specified between finite loads. If the output current is too small, leakage currents dominate and the output voltage rises. A 10mA minimum load current is necessary for proper operation.

Adjustable Regulator Design

The MIC69502 adjustable version allows programming the output voltage anywhere between 0.5V and 5.5V with two resistors. The resistor value between V_{OUT} and the adjust pin should not exceed 10k Ω . Larger values can cause instability. The resistor values are calculated by:

$$V_{OUT} = 0.5 * \left(\frac{R_1}{R_2} + 1 \right)$$

Where V_{OUT} is the desired output voltage.

Enable

The MIC69502 features an active high enable input (EN) that allows on-off control of the regulator. Current drain reduces to near "zero" when the device is shutdown, with only microamperes of leakage current. The EN input has TTL/CMOS compatible thresholds for simple logic interfacing. EN may be directly tied to V_{IN} and pulled up to the maximum supply voltage.

Thermal Design

Linear regulators are simple to use. The most complicated design parameters to consider are thermal characteristics. Thermal design requires the following application-specific parameters:

- Maximum ambient temperature (T_A)
- Output current (I_{OUT})
- Output voltage (V_{OUT})
- Input voltage (V_{IN})
- Ground current (I_{GND})

First, calculate the power dissipation of the regulator from these numbers and the device parameters from this data sheet.

$$P_D = (V_{IN} - V_{OUT}) I_{OUT} + V_{IN} I_{GND}$$

where the ground current is approximated by using numbers from the "Electrical Characteristics" or "Typical Characteristics" sections. The heat sink thermal resistance is then determined with this formula:

$$\theta_{SA} = ((T_J(\max) - T_A) / P_D) - (\theta_{JC} + \theta_{CS})$$

Where $T_J(\max) \leq 125^\circ\text{C}$ and θ_{CS} is between 0°C and 2°C/W .

The heat sink may be significantly reduced in applications where the minimum input voltage is known and is large compared with the dropout voltage. Use a series input resistor to drop excessive voltage and distribute the heat between this resistor and the regulator. The low dropout properties of Micrel Super β PNP[®] regulators allow significant reductions in regulator power dissipation and the associated heat sink

without compromising performance. When this technique is employed, a capacitor of at least 1.0 μ F is needed directly between the input and regulator ground.

Refer to "Application Note 9" for further details and examples on thermal design and heat sink applications.

Package Information

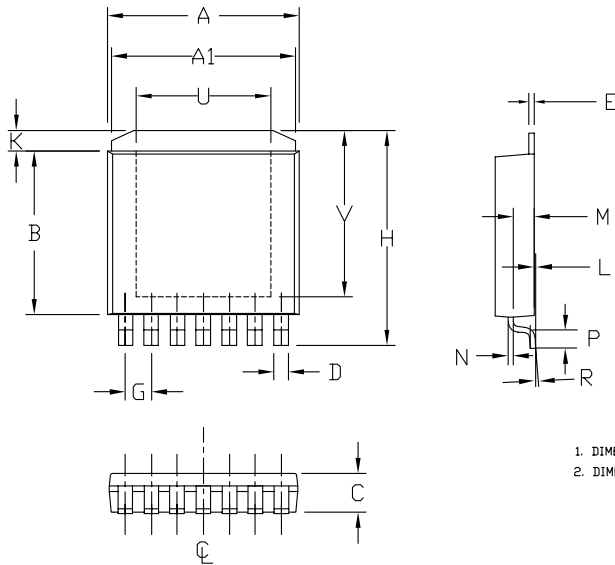

	INCHES		MILLIMETERS	
A	0.365	0.375	9.27	9.52
A1	0.350	0.360	8.89	9.14
B	0.310	0.320	7.87	8.13
C	0.070	0.080	1.78	2.03
D	0.025	0.031	0.63	0.79
E	0.010	BSC	0.25	BSC
G	0.050	BSC	1.27	BSC
H	0.410	0.420	10.41	10.67
K	0.030	0.050	0.76	1.27
L	0.001	0.005	0.03	0.13
M	0.035	0.045	0.89	1.14
N	0.010	BSC	0.25	BSC
P	0.031	0.041	0.79	1.04
R	0°	6°	0°	6°
U	0.256	BSC	6.50	BSC
V	0.316	BSC	8.03	BSC

1. DIMENSION DOES NOT INCLUDE MOLD FLASH OR PROTRUSIONS.
2. DIMENSION INCLUDES PLATING THICKNESS

7-Pin S-PAK (R)

MICREL, INC. 2180 FORTUNE DRIVE SAN JOSE, CA 95131 USA
 TEL +1 (408) 944-0800 FAX +1 (408) 474-1000 WEB <http://www.micrel.com>

The information furnished by Micrel in this data sheet is believed to be accurate and reliable. However, no responsibility is assumed by Micrel for its use. Micrel reserves the right to change circuitry and specifications at any time without notification to the customer.

Micrel Products are not designed or authorized for use as components in life support appliances, devices or systems where malfunction of a product can reasonably be expected to result in personal injury. Life support devices or systems are devices or systems that (a) are intended for surgical implant into the body or (b) support or sustain life, and whose failure to perform can be reasonably expected to result in a significant injury to the user. A Purchaser's use or sale of Micrel Products for use in life support appliances, devices or systems is a Purchaser's own risk and Purchaser agrees to fully indemnify Micrel for any damages resulting from such use or sale.

© 2006 Micrel, Incorporated.

X-ON Electronics

Largest Supplier of Electrical and Electronic Components

Click to view similar products for [LDO Voltage Regulators](#) category:

Click to view products by [Microchip](#) manufacturer:

Other Similar products are found below :

[AP7363-SP-13](#) [L79M05TL-E](#) [PT7M8202B12TA5EX](#) [TCR3DF185,LM\(CT](#) [TCR3DF24,LM\(CT](#) [TCR3DF285,LM\(CT](#) [TCR3DF31,LM\(CT](#)
[TCR3DF45,LM\(CT](#) [MP2013GQ-33-Z](#) [059985X](#) [NCP4687DH15T1G](#) [701326R](#) [TCR2EN28,LF\(S](#) [NCV8170AXV250T2G](#)
[TCR3DF27,LM\(CT](#) [TCR3DF19,LM\(CT](#) [TCR3DF125,LM\(CT](#) [TCR2EN18,LF\(S](#) [AP7315-25W5-7](#) [IFX30081LDVGRNXUMA1](#)
[NCV47411PAAJR2G](#) [AP2113KTR-G1](#) [AP2111H-1.2TRG1](#) [ZLDO1117QK50TC](#) [AZ1117IH-1.8TRG1](#) [TCR3DG12,LF](#) [MIC5514-3.3YMT-](#)
[T5](#) [MIC5512-1.2YMT-T5](#) [MIC5317-2.8YM5-T5](#) [SCD7912BTG](#) [NCP154MX180270TAG](#) [SCD33269T-5.0G](#) [NCV8170BMX330TCG](#)
[NCV8170AMX120TCG](#) [NCP706ABMX300TAG](#) [NCP153MX330180TCG](#) [NCP114BMX075TCG](#) [MC33269T-3.5G](#) [CAT6243-ADJCMT5T](#)
[TCR3DG33,LF](#) [AP2127N-1.0TRG1](#) [TCR4DG35,LF](#) [LT1117CST-3.3](#) [LT1117CST-5](#) [TAR5S15U\(TE85L,F\)](#) [TAR5S18U\(TE85L,F\)](#)
[TCR3UG19A,LF](#) [TCR4DG105,LF](#) [NCV8170AMX360TCG](#) [MIC94310-NYMT-T5](#)