



MIC910

135MHz, Low-Power SOT-23-5 Op Amp

General Description

The MIC910 is a high-speed, unity-gain stable operational amplifier. It provides a gain-bandwidth product of 135MHz with a very low, 2.4mA supply current, and features the tiny SOT-23-5 package.

Supply voltage range is from $\pm 2.5V$ to $\pm 9V$, allowing the MIC910 to be used in low-voltage circuits or applications requiring large dynamic range.

The MIC910 is stable driving any capacitive load and achieves excellent PSRR, making it much easier to use than most conventional high-speed devices. Low supply voltage, low power consumption, and small packing make the MIC910 ideal for portable equipment. The ability to drive capacitive loads also makes it possible to drive long coaxial cables.

Datasheets and support documentation are available on Micrel's web site at: www.micrel.com.

Features

- 135MHz gain bandwidth product
- 2.4mA supply current
- Unconditionally unity-gain stable
- SOT-23-5 package
- 270V/ μs slew rate
- Drives any capacitive load

Applications

- Video
- Imaging
- Ultrasound
- Portable equipment
- Line drivers

Functional Pinout

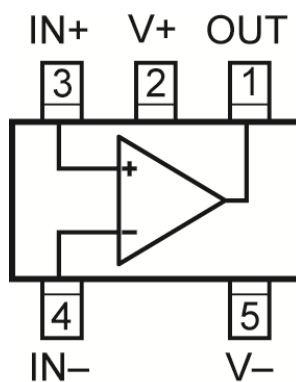

SOT-23-5

Ordering Information

Part Number ⁽¹⁾	Marking	Junction Temperature Range	Package
MIC910YM5	<u>A21</u>	-40°C to +85°C	SOT-23-5

Note:

- Underbar () may not be to scale.

Pin Configuration

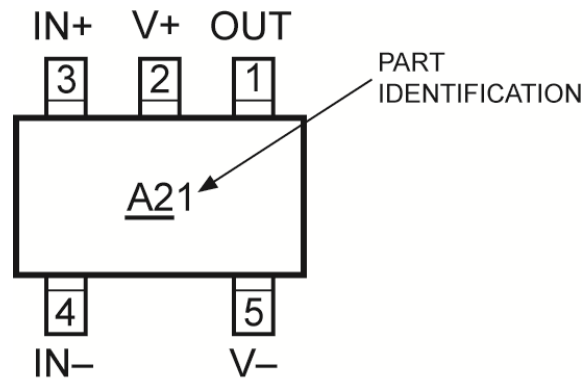

SOT-23-5 (M5)
(Top View)

Pin Description

Pin Number	Pin Name	Pin Function
1	OUT	Output: Amplifier output.
2	V+	Positive Supply (Input): Connect a 10μF capacitor in parallel with a 0.1μF capacitor to ground.
3	IN+	Noninverting Input.
4	IN-	Inverting Input.
5	V-	Negative Supply (Input): Connect a 10μF capacitor in parallel with a 0.1μF capacitor to ground.

Absolute Maximum Ratings⁽²⁾

Supply Voltage ($V_{V+} - V_{V-}$)	+20V
Differential Input Voltage ($ V_{IN+} - V_{IN-} $)	8V ⁽⁴⁾
Input Common-Mode Range (V_{IN+}, V_{IN-})	V_{V+} to V_{V-}
Lead Temperature (soldering, 5s)	+260°C
Storage Temperature (T_S)	+150°C
ESD Rating ⁽⁵⁾	1.5kV

Operating Ratings⁽³⁾

Supply Voltage (V_S)	$\pm 2.5V$ to $\pm 9V$
Junction Temperature (T_J)	-40°C to $+85^\circ\text{C}$
Package Thermal Resistance	
SOT-23-5 (θ_{JA})	+260°C/W

Electrical Characteristics ($\pm 5V$)

$V_{V+} = +5V$; $V_{V-} = -5V$, $V_{CM} = 0V$, $V_{OUT} = 0V$; $R_L = 10M\Omega$; $T_J = +25^\circ\text{C}$, **bold** values indicate $-40^\circ\text{C} \leq T_J \leq +85^\circ\text{C}$, unless noted.

Symbol	Parameter	Condition	Min.	Typ.	Max.	Units
V_{OS}	Input Offset Voltage			1	15	mV
	Input Offset Voltage Temperature Coefficient			4		$\mu\text{V}/^\circ\text{C}$
I_B	Input Bias Current			3.5	5.5	μA
					9	
I_{OS}	Input Offset Current			0.05	3	μA
V_{CM}	Input Common-Mode Range	CMRR > 60dB	-3.25		+3.25	V
CMRR	Common-Mode Rejection Ratio	$-2.5V < V_{CM} < +2.5V$	70	90		dB
			60			
PSRR	Power Supply Rejection Ratio	$\pm 5V < V_S < \pm 9V$	74	81		dB
			70			
A_{VOL}	Large-Signal Voltage Gain	$R_L = 2k\Omega$, $V_{OUT} = \pm 2V$	60	71		dB
		$R_L = 200\Omega$, $V_{OUT} = \pm 2V$	60	71		
V_{OUT}	Maximum Output Voltage Swing	Positive, $R_L = 2k\Omega$	+3.3	3.5		V
			+3.0			
		Negative, $R_L = 2k\Omega$		-3.5	-3.3	
					-3.0	
Positive, $R_L = 200\Omega$	+3.0	3.2				
	+2.75					
Negative, $R_L = 200\Omega$		-2.8	-2.45			
			-2.2			
GBW	Gain Bandwidth Product	$R_L = 1k\Omega$		125		MHz
BW	-3dB Bandwidth	$A_V = 1$, $R_L = 100\Omega$		192		MHz
SR	Slew Rate			230		V/ μs
I_{GND}	Short-Circuit Output Current	Source		72		mA
		Sink		25		
	Supply Current			2.4	3.5	
					4.1	

Notes:

- Exceeding the absolute maximum ratings may damage the device.
- The device is not guaranteed to function outside its operating ratings.
- Exceeding the maximum differential input voltage will damage the input stage and degrade performance as input bias current is likely to increase.
- Devices are ESD sensitive. Handling precautions are recommended. Human body model, 1.5k Ω in series with 100pF.

Electrical Characteristics ($\pm 9V$)

$V_{V+} = +9V$; $V_{V-} = -9V$, $V_{CM} = 0V$, $V_{OUT} = 0V$; $R_L = 10M\Omega$; $T_J = +25^\circ C$, **bold** values indicate $-40^\circ C \leq T_J \leq +85^\circ C$, unless noted.

Symbol	Parameter	Condition	Min.	Typ.	Max.	Units	
V_{OS}	Input Offset Voltage			1	15	mV	
	Input Offset Voltage Temperature Coefficient			4		$\mu V/^\circ C$	
I_B	Input Bias Current			3.5	5.5	μA	
					9		
I_{OS}	Input Offset Current			0.05	3	μA	
V_{CM}	Input Common-Mode Range	CMRR > 60dB	-7.25		+7.25	V	
CMRR	Common-Mode Rejection Ratio	$-6.5V < V_{CM} < +6.5V$	70	98		dB	
			60				
A_{VOL}	Large-Signal Voltage Gain	$R_L = 2k\Omega$, $V_{OUT} = \pm 6V$	60	73		dB	
V_{OUT}	Maximum Output Voltage Swing	Positive, $R_L = 2k\Omega$	+7.2	7.4		V	
			+6.8				
		Negative, $R_L = 2k\Omega$		-7.4	-7.2		
					-6.8		
GBW	Gain Bandwidth Product	$R_L = 1k\Omega$		135		MHz	
SR	Slew Rate			270		V/ μs	
I_{GND}	Short-Circuit Output Current	Source		90		mA	
		Sink		32			
	Supply Current			2.5	3.7		
					4.3		

Test Circuit

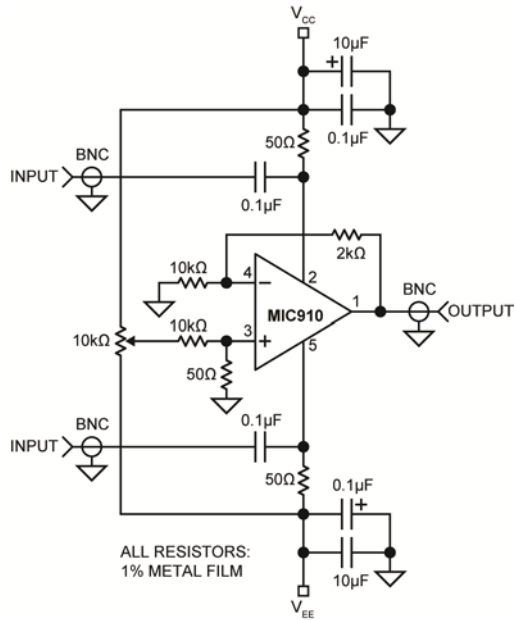

PSRR vs. Frequency

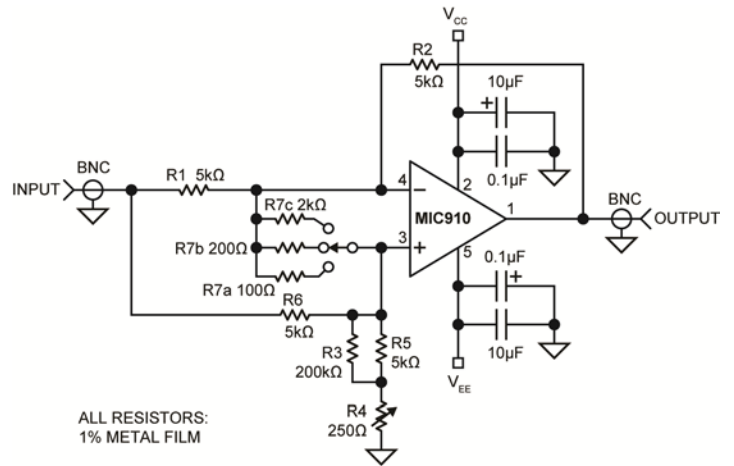

$$V_{OUT} = V_{ERROR} \left(1 + \frac{R2}{R1} + \frac{R2 + R5 + R4}{R7} \right)$$

CMRR vs. Frequency

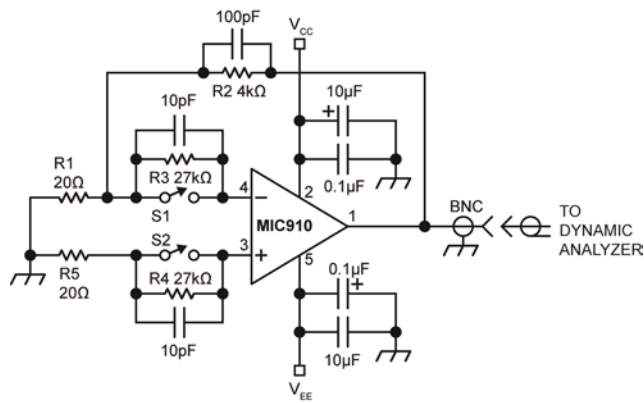

Noise Measurement

Typical Characteristics

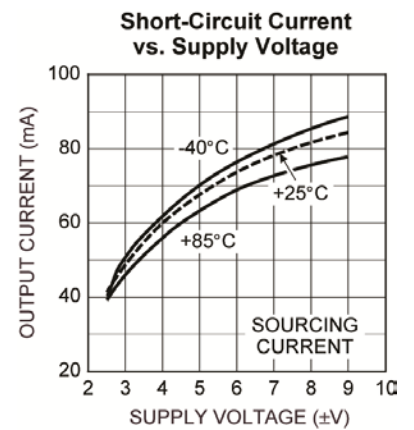
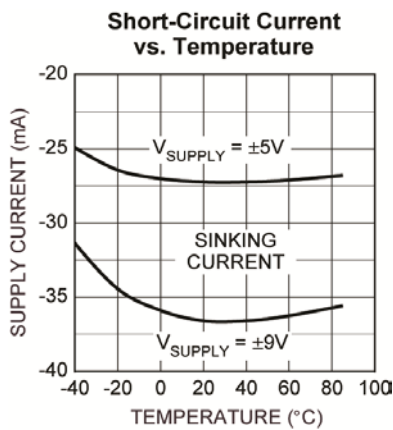
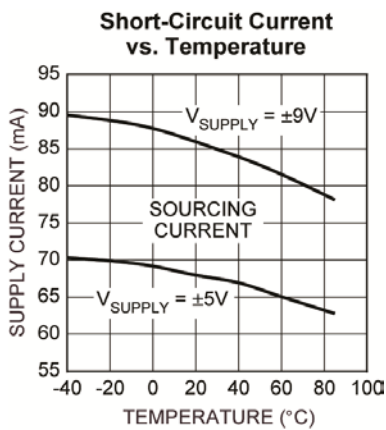
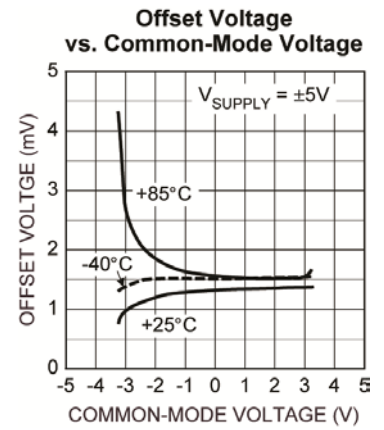
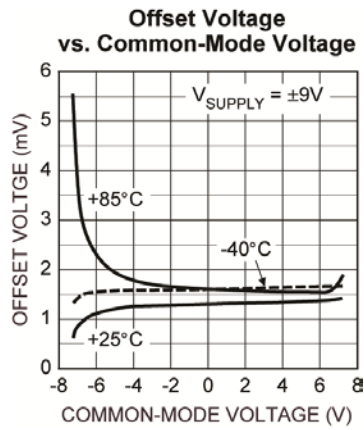
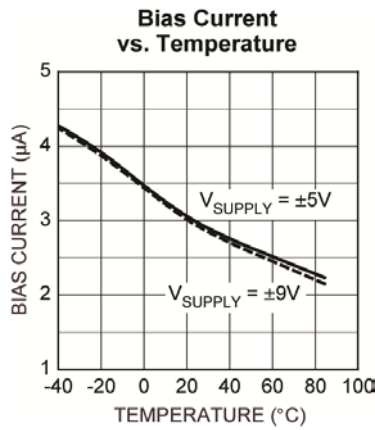
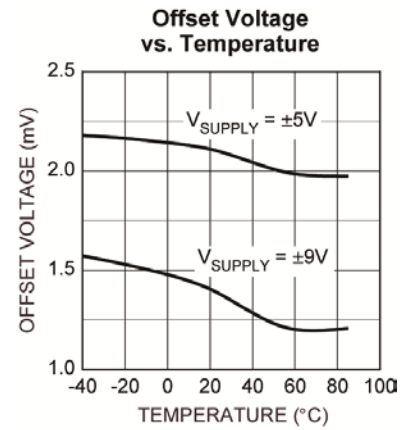
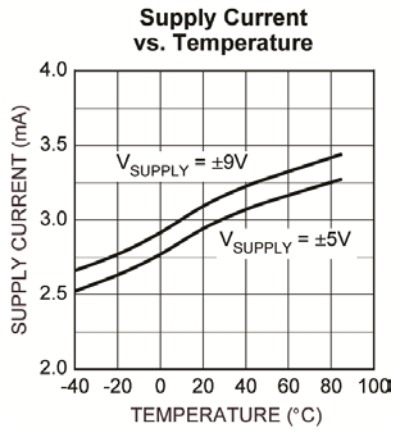
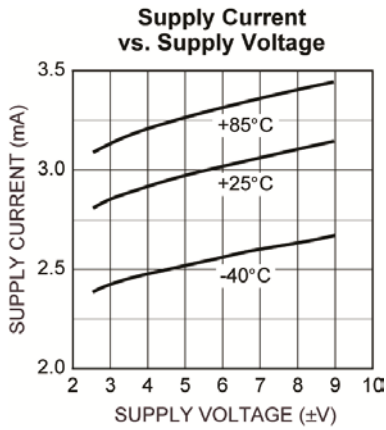

Typical Characteristics (Continued)

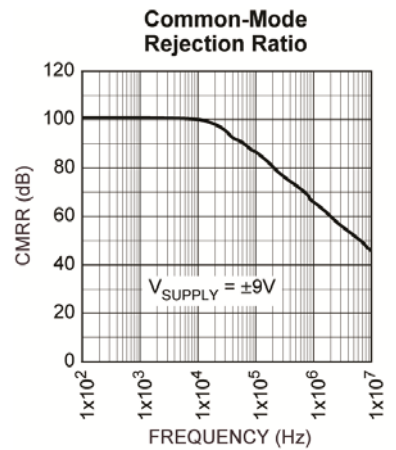
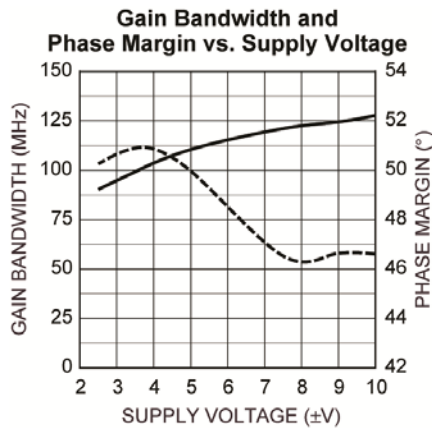
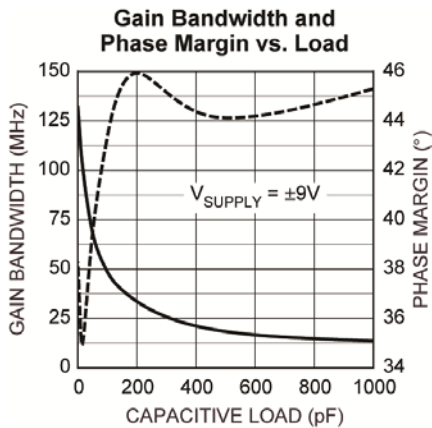
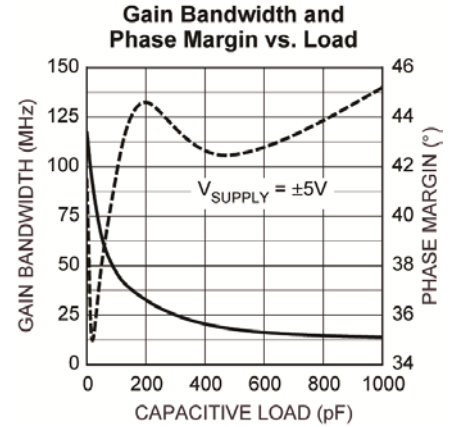
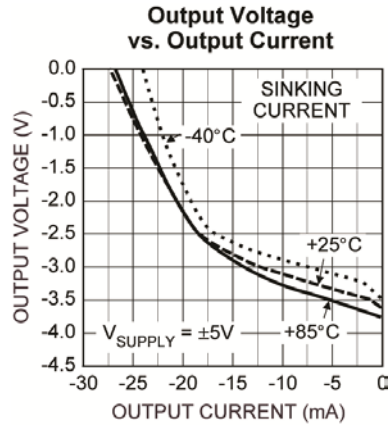
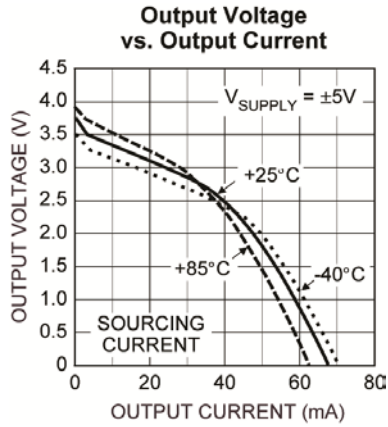
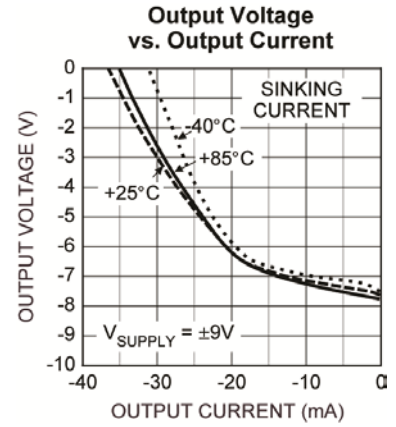
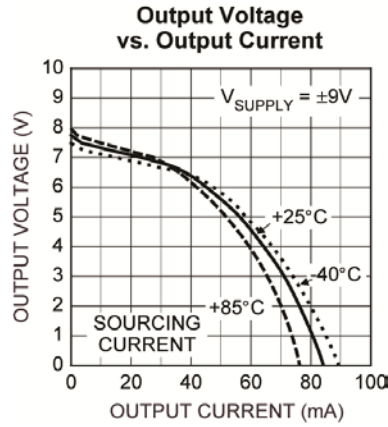
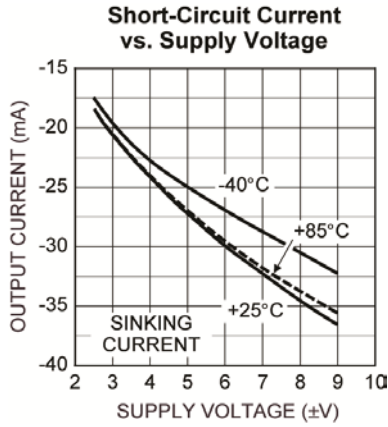

Typical Characteristics (Continued)

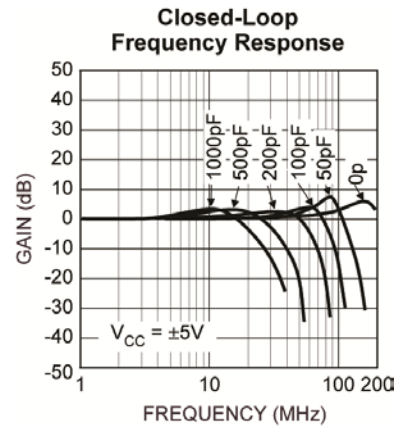
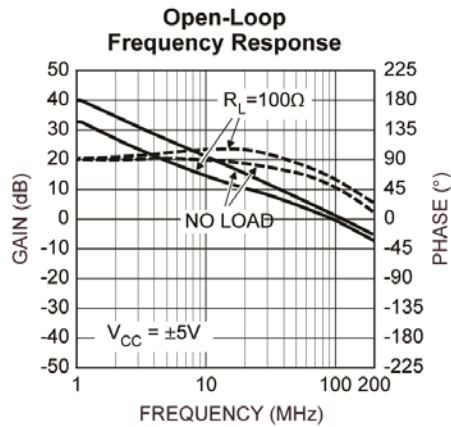
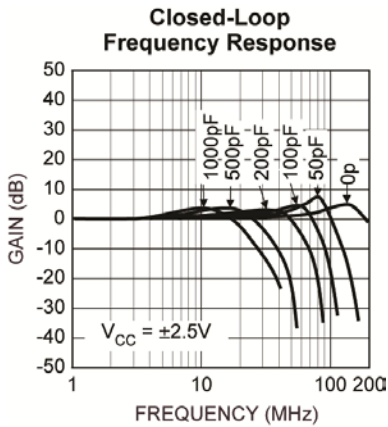
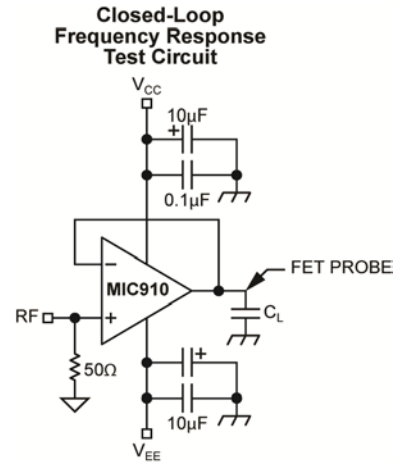
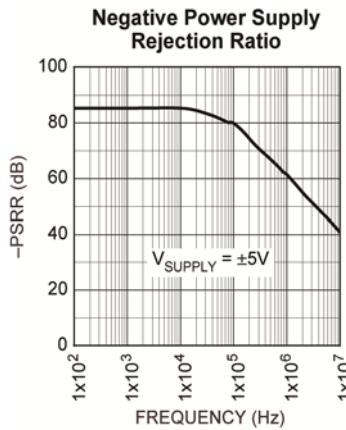
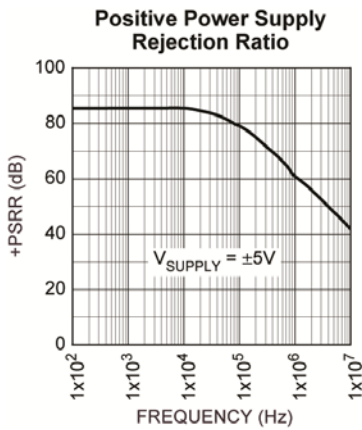
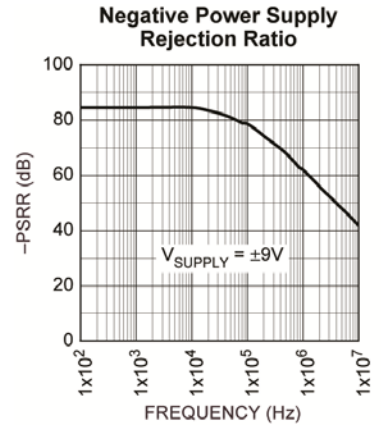
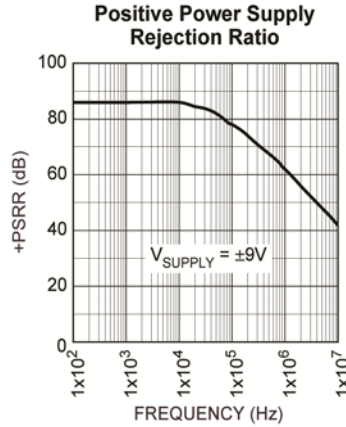
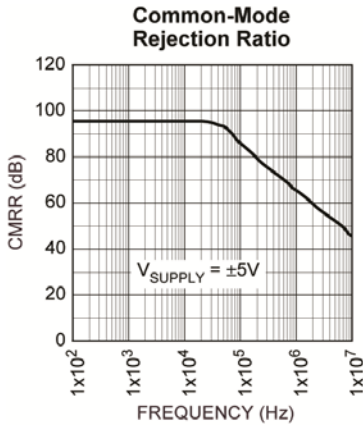

Typical Characteristics (Continued)

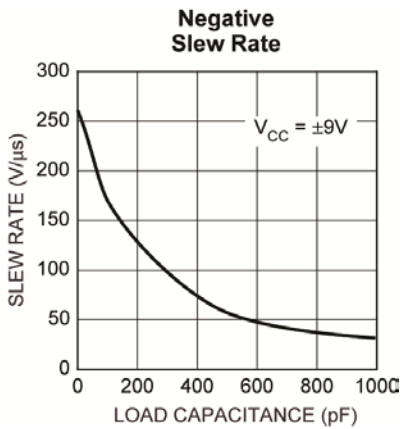
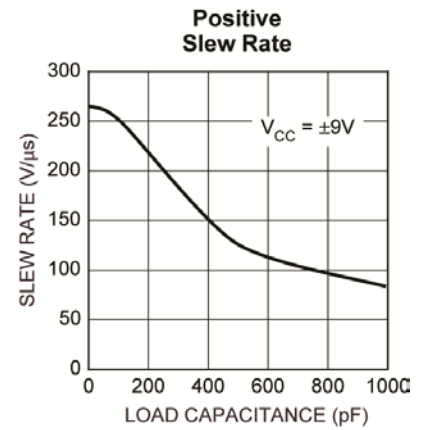
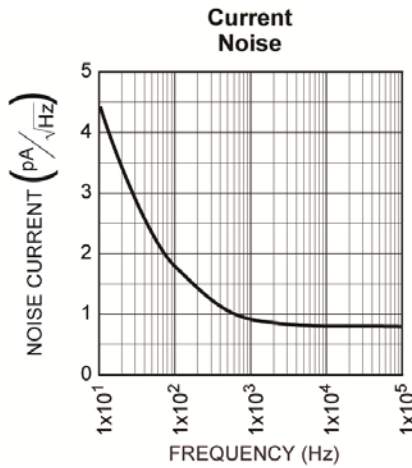
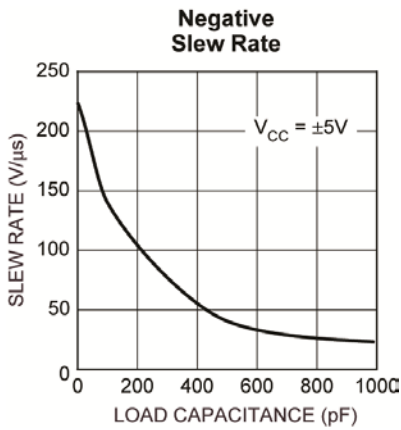
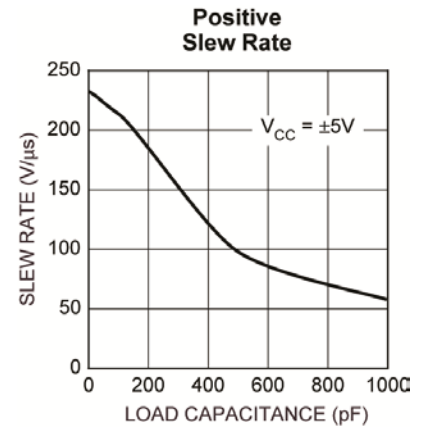
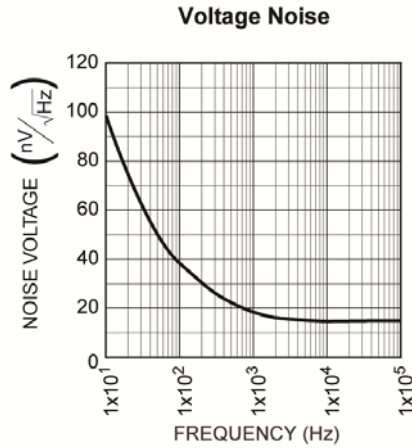
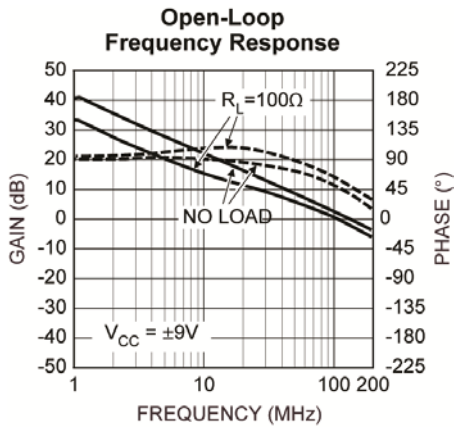

Functional Characteristics

Small Signal Pulse Response

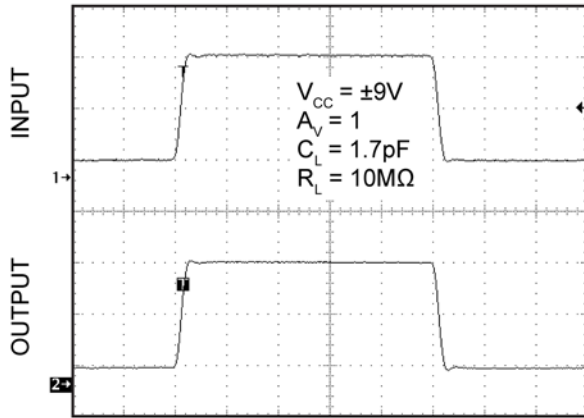

Time (100ns/div)

Small Signal Pulse Response

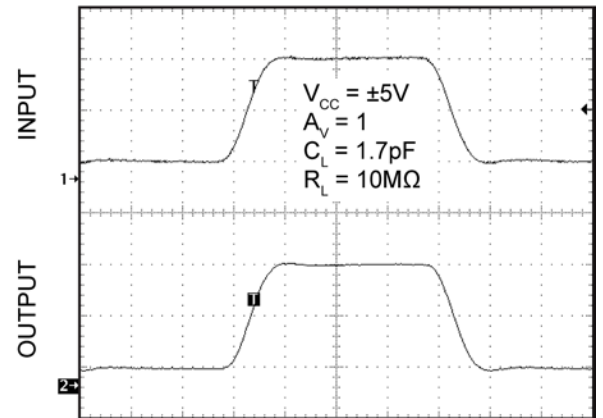

Time (25.0ns/div)

Small Signal Pulse Response

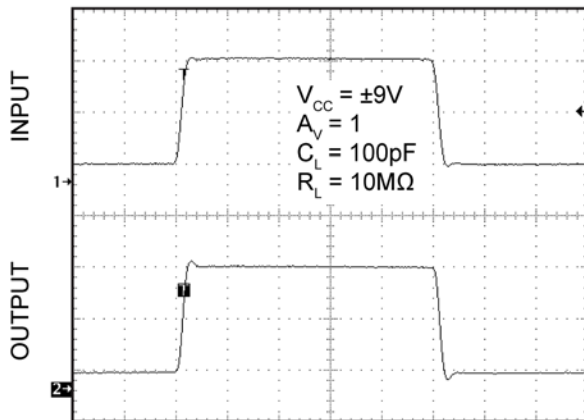

Time (100ns/div)

Small Signal Pulse Response

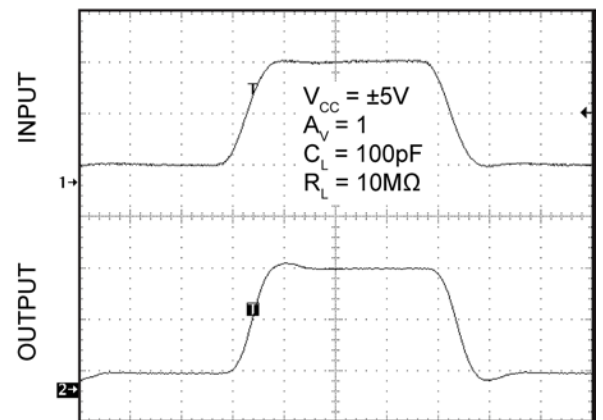

Time (25.0ns/div)

Small Signal Pulse Response

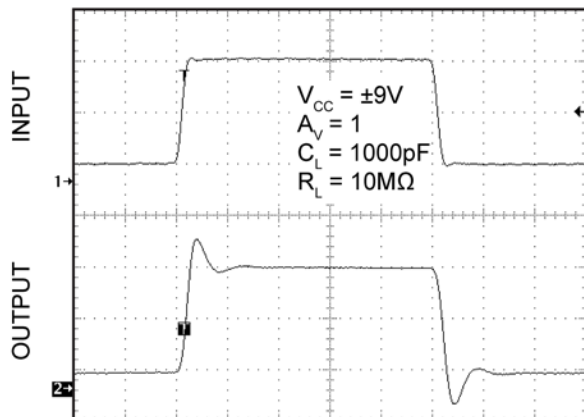

Time (100ns/div)

Small Signal Pulse Response

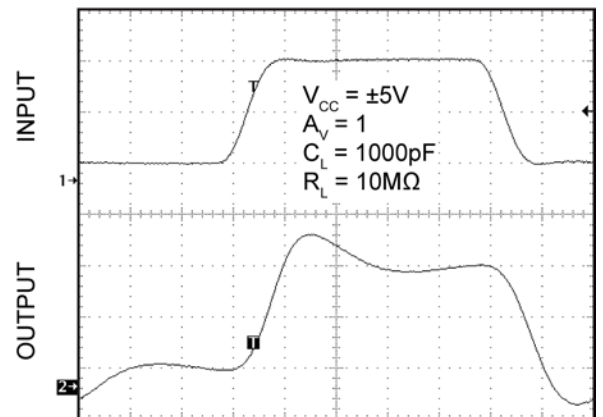

Time (25.0ns/div)

Functional Characteristics (Continued)

Large Signal Pulse Response

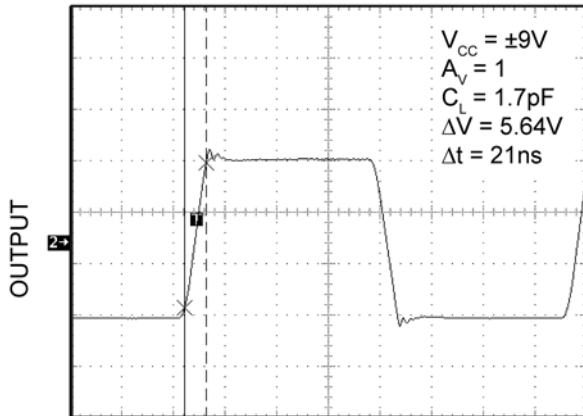

Time (50.0ns/div)

Large Signal Pulse Response

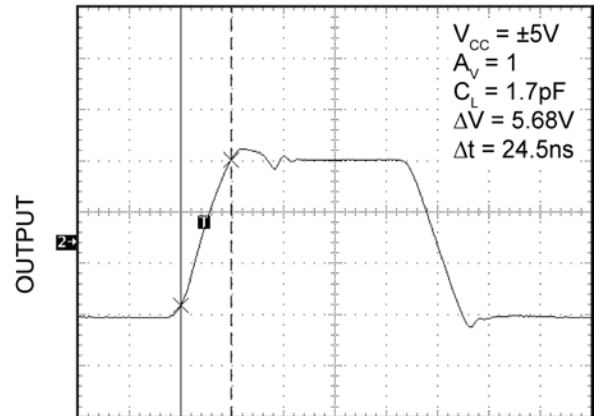

Time (25.0ns/div)

Large Signal Pulse Response

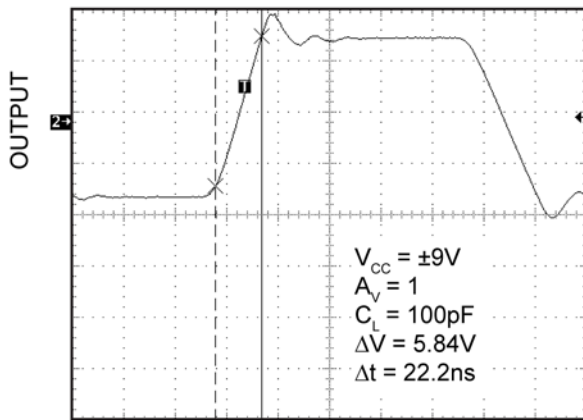

Time (25.0ns/div)

Large Signal Pulse Response

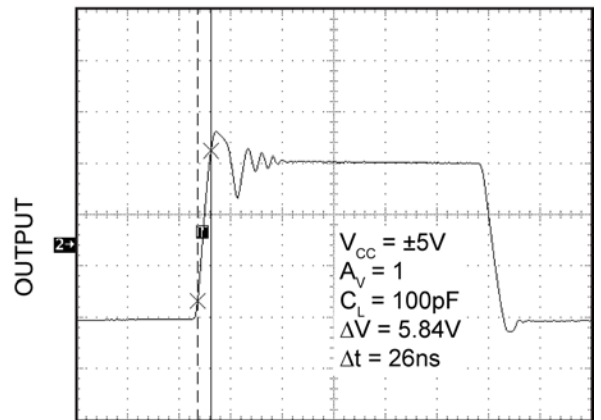

Time (100ns/div)

Large Signal Pulse Response

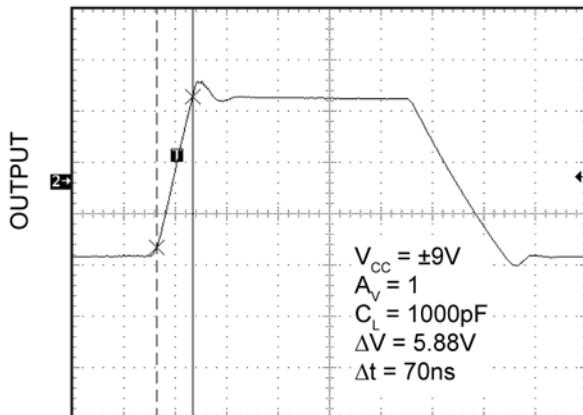

Time (100ns/div)

Large Signal Pulse Response

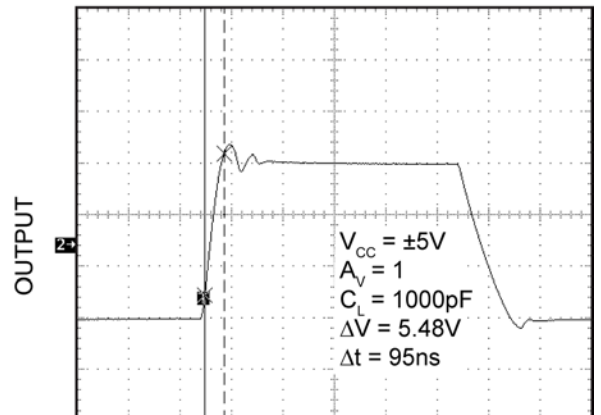

Time (250ns/div)

Application Information

The MIC910 is a high-speed, voltage-feedback operational amplifier featuring very low supply current and excellent stability. This device is unity gain stable and capable of driving high capacitance loads.

Driving High Capacitance

The MIC910 is stable when driving any capacitance (see the “Gain Bandwidth and Phase Margin vs. Load Capacitance” graph in the *Typical Characteristics* section) making it ideal for driving long coaxial cables or other high-capacitance loads.

Phase margin remains constant as load capacitance is increased. Most high-speed op amps are only able to drive limited capacitance.

Note: increasing load capacitance does reduce the speed of the device (see the “Gain Bandwidth and Phase Margin vs. Load” in the *Typical Characteristics* section). In applications where the load capacitance reduces the speed of the op amp to an unacceptable level, the effect of the load capacitance can be reduced by adding a small resistor (<100Ω) in series with the output.

Feedback Resistor Selection

Conventional op amp gain configurations and resistor selection apply; the MIC910 is not a current feedback device. Resistor values in the range of 1kΩ to 10kΩ are recommended.

Layout Considerations

All high-speed devices require careful PCB layout. The high stability and high PSRR of the MIC910 make it easier to use than most other op amps, but the following guidelines should be observed:

- Capacitance, particularly on the two inputs pins will degrade performance.
- Avoid large copper traces to the inputs.
- Keep the output signal away from the inputs and use a ground plane.

It is important to ensure adequate supply bypassing capacitors are located close to the device

Power Supply Bypassing

Regular supply bypassing techniques are recommended. A 10μF capacitor in parallel with a 0.1μF capacitor on both the positive and negative supplies is ideal. For best performance, all bypassing capacitors should be located as close to the op amp as possible and all capacitors should be low equivalent series inductance (ESL) and equivalent series resistance (ESR). Surface-mount ceramic capacitors are ideal.

Thermal Considerations

The SOT-23-5 package, like all small packages, has a high thermal resistance. It is important to ensure the IC does not exceed the maximum operating junction (die) temperature of 85°C. The part can be operated up to the absolute maximum temperature rating of 125°C, but between 85°C and 125°C performance will degrade, in particular CMRR will reduce.

A MIC910 with no load, dissipates power equal to the quiescent supply current × the supply voltage (Equation 1):

$$P_{D(\text{NO LOAD})} = (V_{V+} - V_{V-})I_S \quad \text{Eq. 1}$$

When a load is added, the additional power is dissipated in the output stage of the op amp. The power dissipated in the device is a function of supply voltage, output voltage and output current (Equation 2).

$$P_{D(\text{OUTPUT STAGE})} = (V_{V+} - V_{\text{OUT}})I_{\text{OUT}} \quad \text{Eq. 2}$$

$$\text{Total Power Dissipation} = P_{D(\text{NO LOAD})} + P_{D(\text{OUTPUT STAGE})}$$

Ensure the total power dissipated in the device is no greater than the thermal capacity of the package. The SOT23-5 package has a thermal resistance of 260°C/W (Equation 3).

$$\text{Maximum Allowable Power Dissipation} =$$

$$\frac{T_{J(\text{MAX})} - T_{A(\text{MAX})}}{260^\circ\text{C/W}} \quad \text{Eq. 3}$$

Package Information and Recommended Landing Pattern⁽⁶⁾

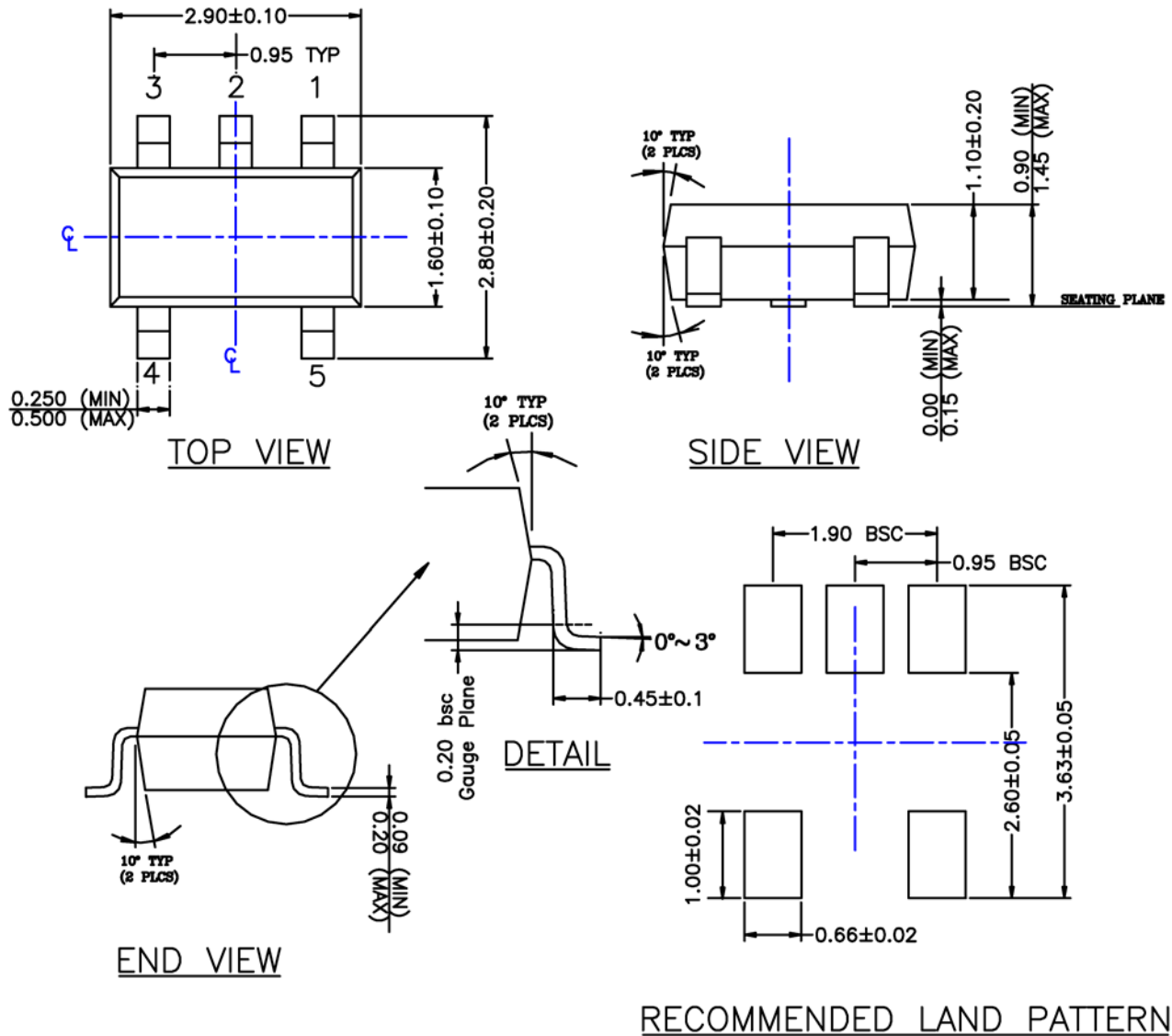

- NOTE:
1. PACKAGE OUTLINE EXCLUSIVE OF MOLD FLASH & BURR.
 2. PACKAGE OUTLINE INCLUSIVE OF SOLER PLATING.
 3. DIMENSION AND TOLERANCE PER ANSI Y14.5M, 1982.
 4. FOOT LENGTH MEASUREMENT BASED ON GAUGE PLANE METHOD.
 5. DIE FACES UP FOR MOLD, AND FACES DOWN FOR TRIM/FORM.
 6. ALL DIMENSIONS ARE IN MILLIMETERS.

SOT-23-5 (M5)

Note:

6. Package information is correct as of the publication date. For updates and most current information, go to www.micrel.com.

MICREL, INC. 2180 FORTUNE DRIVE SAN JOSE, CA 95131 USA
TEL +1 (408) 944-0800 FAX +1 (408) 474-1000 WEB <http://www.micrel.com>

Micrel, Inc. is a leading global manufacturer of IC solutions for the worldwide high performance linear and power, LAN, and timing & communications markets. The Company's products include advanced mixed-signal, analog & power semiconductors; high-performance communication, clock management, MEMs-based clock oscillators & crystal-less clock generators, Ethernet switches, and physical layer transceiver ICs. Company customers include leading manufacturers of enterprise, consumer, industrial, mobile, telecommunications, automotive, and computer products. Corporation headquarters and state-of-the-art wafer fabrication facilities are located in San Jose, CA, with regional sales and support offices and advanced technology design centers situated throughout the Americas, Europe, and Asia. Additionally, the Company maintains an extensive network of distributors and reps worldwide.

Micrel makes no representations or warranties with respect to the accuracy or completeness of the information furnished in this datasheet. This information is not intended as a warranty and Micrel does not assume responsibility for its use. Micrel reserves the right to change circuitry, specifications and descriptions at any time without notice. No license, whether express, implied, arising by estoppel or otherwise, to any intellectual property rights is granted by this document. Except as provided in Micrel's terms and conditions of sale for such products, Micrel assumes no liability whatsoever, and Micrel disclaims any express or implied warranty relating to the sale and/or use of Micrel products including liability or warranties relating to fitness for a particular purpose, merchantability, or infringement of any patent, copyright, or other intellectual property right.

Micrel Products are not designed or authorized for use as components in life support appliances, devices or systems where malfunction of a product can reasonably be expected to result in personal injury. Life support devices or systems are devices or systems that (a) are intended for surgical implant into the body or (b) support or sustain life, and whose failure to perform can be reasonably expected to result in a significant injury to the user. A Purchaser's use or sale of Micrel Products for use in life support appliances, devices or systems is a Purchaser's own risk and Purchaser agrees to fully indemnify Micrel for any damages resulting from such use or sale.

© 2001 Micrel, Incorporated.

X-ON Electronics

Largest Supplier of Electrical and Electronic Components

Click to view similar products for [Operational Amplifiers - Op Amps](#) category:

Click to view products by [Microchip](#) manufacturer:

Other Similar products are found below :

[OPA2991IDSGR](#) [OPA607IDCKT](#) [007614D](#) [633773R](#) [635798C](#) [635801A](#) [702115D](#) [709228FB](#) [741528D](#) [NCV33072ADR2G](#)
[SC2902DTBR2G](#) [SC2903VDR2G](#) [LM258AYDT](#) [LM358SNG](#) [430227FB](#) [430228DB](#) [460932C](#) [AZV831KTR-G1](#) [409256CB](#) [430232AB](#)
[LM2904DR2GH](#) [LM358YDT](#) [LT1678IS8](#) [042225DB](#) [058184EB](#) [070530X](#) [SC224DR2G](#) [SC239DR2G](#) [SC2902DG](#) [SCYA5230DR2G](#)
[714228XB](#) [714846BB](#) [873836HB](#) [MIC918YC5-TR](#) [TS912BIYDT](#) [NCS2004MUTAG](#) [NCV33202DMR2G](#) [M38510/13101BPA](#) [NTE925](#)
[SC2904DR2G](#) [SC358DR2G](#) [LM358EDR2G](#) [AP4310AUMTR-AG1](#) [HA1630D02MMEL-E](#) [NJM358CG-TE2](#) [HA1630S01LPEL-E](#)
[LM324AWPT](#) [HA1630Q06TELL-E](#) [NJM4558CG-TE2](#) [AZV358MMTR-G1](#)