

80 MHz Low-Power SC70 Op Amp

Features

- 80 MHz Gain Bandwidth Product
- 115 MHz -3dB Bandwidth
- 550 μA Supply Current (Typical)
- 5-Lead SC70 Package
- 3000V/ μs Slew Rate (Typical)
- Drives Any Capacitive Load
- Unity Gain Stable

Applications

- Video
- Imaging
- Ultrasound
- Portable Equipment
- Line Drivers

General Description

The MIC920 is a high-speed operational amplifier with a gain-bandwidth product of 80 MHz. The part is unity gain stable. It has a very low 550 μA supply current, and features the 5-Lead SC70 package.

Supply voltage range is from $\pm 2.5\text{V}$ to $\pm 9\text{V}$, allowing the MIC920 to be used in low voltage circuits or applications requiring large dynamic range.

The MIC920 is stable driving any capacitive load and achieves excellent PSRR and CMRR, making it much easier to use than most conventional high-speed devices. Low supply voltage, low power consumption, and small packing make the MIC920 ideal for portable equipment. The ability to drive capacitive loads also makes it possible to drive long coaxial cables.

Package Type

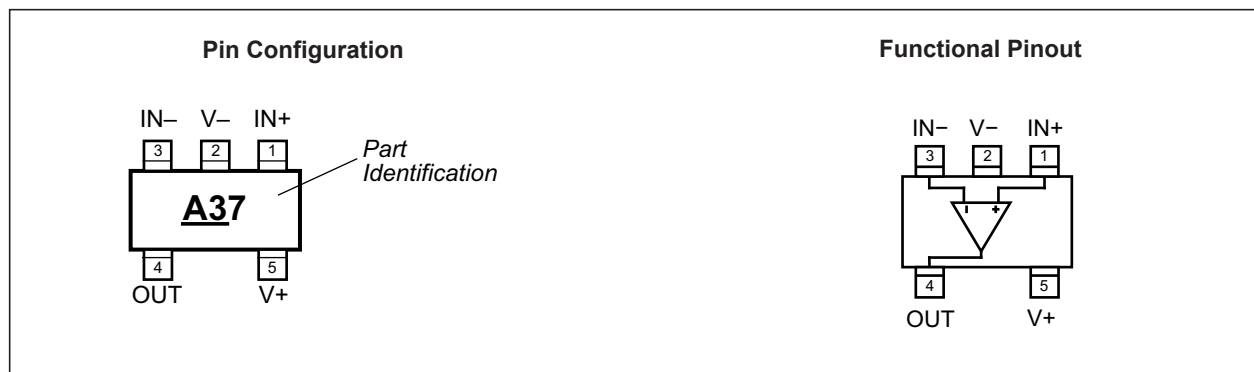

MIC920

1.0 ELECTRICAL CHARACTERISTICS

Absolute Maximum Ratings †

Supply Voltage (V_{V+} to V_{V-}).....	20V
Differential Input Voltage (V_{IN+} to V_{IN-}) (Note 1).....	4V
Input Common Mode Range (V_{IN+} to V_{IN-}).....	V_{V+} to V_{V-}
ESD Rating (Note 2).....	1.5 kV

Operating Ratings ‡

Supply Voltage (V_S).....	$\pm 2.5V$ to $\pm 9V$
-------------------------------	------------------------

† **Notice:** Stresses above those listed under “Absolute Maximum Ratings” may cause permanent damage to the device. This is a stress rating only and functional operation of the device at those or any other conditions above those indicated in the operational sections of this specification is not intended. Exposure to maximum rating conditions for extended periods may affect device reliability.

‡ **Notice:** The device is not guaranteed to function outside the operating ratings.

- Note 1:** Exceeding the maximum differential input voltage will damage the input stage and degrade performance (in particular, input bias current is likely to change).
- 2:** Devices are ESD sensitive. Handling precautions are recommended. Human body model, 1.5 k Ω in series with 100 pF. Pin 4 is ESD sensitive.

ELECTRICAL CHARACTERISTICS (±5V)

Electrical Characteristics: $V_+ = +5V$, $V_- = -5V$, $V_{CM} = 0V$, $R_L = 10\text{ M}\Omega$; $T_A = 25^\circ\text{C}$, unless otherwise noted.						
Parameters	Symbol	Min.	Typ.	Max.	Units	Conditions
Input Offset Voltage	V_{OS}	—	0.43	5	mV	$-40^\circ\text{C} \leq T_J \leq +85^\circ\text{C}$
Input Offset Voltage Temperature Coefficient	$\Delta V_{OS}/\Delta T_A$	—	1	—	$\mu\text{V}/^\circ\text{C}$	$-40^\circ\text{C} \leq T_J \leq +85^\circ\text{C}$
Input Bias Current	I_B	—	0.26	0.6	μA	$-40^\circ\text{C} \leq T_J \leq +85^\circ\text{C}$
Input Offset Current	I_{OS}	—	0.04	0.3	μA	$-40^\circ\text{C} \leq T_J \leq +85^\circ\text{C}$
Input Common-Mode Range	V_{CM}	-3.25	—	+3.25	V	CMRR > 72 dB, $-40^\circ\text{C} \leq T_J \leq +85^\circ\text{C}$
Common-Mode Rejection Ratio	CMRR	75	85	—	dB	$-2.5V < V_{CM} < +2.5V$
Power Supply Rejection Ratio	PSRR	95	104	—	dB	$\pm 3.5V < V_S < \pm 9V$
Large-Signal Voltage Gain	A_{VOL}	65	82	—	dB	$R_L = 2\text{ k}\Omega$, $V_{OUT} = \pm 2V$
		—	85	—	dB	$R_L = 100\Omega$, $V_{OUT} = \pm 1V$
Maximum Output Voltage Swing	V_{OUT}	+3.0	3.6	—	V	Positive, $R_L = 2\text{ k}\Omega$ $-40^\circ\text{C} \leq T_J \leq +85^\circ\text{C}$
		—	-3.6	-3.0	V	Negative, $R_L = 2\text{ k}\Omega$ $-40^\circ\text{C} \leq T_J \leq +85^\circ\text{C}$
Unity Gain-Bandwidth Product	G_{BW}	—	67	—	MHz	$C_L = 1.7\text{ pF}$
Phase Margin	P_M	—	32	—	$^\circ$	—
-3 dB Bandwidth	B_W	—	100	—	MHz	$A_V = 1$, $C_L = 1.7\text{ pF}$, $R_L = 1\text{ k}\Omega$
Slew Rate	S_R	—	1350	—	V/ μs	$C = 1.7\text{ pF}$, Gain = 1, $V_{OUT} = 5V$, Peak to Peak, Positive SR = 1190V/ μs
Short-Circuit Output Current	I_{SC}	45	63	—	mA	Source
		20	45	—		Sink
Supply Current	I_S	—	0.55	0.80	mA	No load, $-40^\circ\text{C} \leq T_J \leq +85^\circ\text{C}$
Input Voltage Noise	—	—	11	—	nV/ $\sqrt{\text{Hz}}$	$f = 10\text{ kHz}$
Input Current Noise	—	—	0.7	—	pA/ $\sqrt{\text{Hz}}$	$f = 10\text{ kHz}$

MIC920

ELECTRICAL CHARACTERISTICS

Electrical Characteristics: $V_+ = +9V$, $V_- = -9V$, $V_{CM} = 0V$, $R_L = 10\text{ M}\Omega$; $T_J = 25^\circ\text{C}$, unless otherwise noted.						
Parameters	Symbol	Min.	Typ.	Max.	Units	Conditions
Input Offset Voltage	V_{OS}	—	0.3	5	mV	$-40^\circ\text{C} \leq T_J \leq +85^\circ\text{C}$
Input Offset Voltage Temperature Coefficient	$\Delta V_{OS}/\Delta T_A$	—	1	—	$\mu\text{V}/^\circ\text{C}$	$-40^\circ\text{C} \leq T_J \leq +85^\circ\text{C}$
Input Bias Current	I_B	—	0.23	0.60	μA	$-40^\circ\text{C} \leq T_J \leq +85^\circ\text{C}$
Input Offset Current	I_{OS}	—	0.04	0.3	μA	$-40^\circ\text{C} \leq T_J \leq +85^\circ\text{C}$
Input Common-Mode Range	V_{CM}	-7.25	—	+7.25	V	CMRR > 75 dB, $-40^\circ\text{C} \leq T_J \leq +85^\circ\text{C}$
Common-Mode Rejection Ratio	CMRR	60	91	—	dB	$-6.5V < V_{CM} < +6.5V$
Power Supply Rejection Ratio	PSRR	95	104	—	dB	$\pm 3.5V < V_S < \pm 9V$
Large-Signal Voltage Gain	A_{VOL}	75	84	—	dB	$R_L = 2k$, $V_{OUT} = \pm 2V$
		—	93	—	dB	$R_L = 100\Omega$, $V_{OUT} = \pm 1V$
Maximum Output Voltage Swing	V_{OUT}	6.5	7.5	—	V	Positive, $R_L = 2\text{ k}\Omega$, $-40^\circ\text{C} \leq T_J \leq +85^\circ\text{C}$
		—	-7.5	-6.2	V	Negative, $R_L = 2\text{ k}\Omega$, $-40^\circ\text{C} \leq T_J \leq +85^\circ\text{C}$
Unity Gain-Bandwidth Product	G_{BW}	—	80	—	MHz	$C_L = 1.7\text{ pF}$
Phase Margin	P_M	—	30	—	$^\circ$	—
-3 dB Bandwidth	B_W	—	115	—	MHz	$A_V = 1$, $C_L = 1.7\text{ pF}$, $R_L = 1\text{ k}\Omega$
Slew Rate	S_R	—	3000	—	V/ μs	$C = 1.7\text{ pF}$, Gain = 1, $V_{OUT} = 5V$, Peak to Peak, Positive SR = 2500V/ μs
Short-Circuit Output Current	I_{SC}	50	65	—	mA	Source
		30	50	—		Sink
Supply Current	I_S	—	0.55	0.8	mA	No load, $-40^\circ\text{C} \leq T_J \leq +85^\circ\text{C}$
Input Voltage Noise	—	—	10	—	nV/ $\sqrt{\text{Hz}}$	$f = 10\text{ kHz}$
Input Current Noise	—	—	0.8	—	pA/ $\sqrt{\text{Hz}}$	$f = 10\text{ kHz}$

TEMPERATURE SPECIFICATIONS (Note 1)

Parameters	Symbol	Min.	Typ.	Max.	Units	Conditions
Temperature Ranges						
Storage Temperature	T_S	—	—	150	°C	—
Operating Junction Temperature Range	T_J	-40	—	+85	°C	—
Lead Temperature	—	—	—	260	°C	Soldering, 5 sec.
Package Thermal Resistance						
Thermal Resistance SC70	—	—	450	—	°C/W	—

Note 1: The maximum allowable power dissipation is a function of ambient temperature, the maximum allowable junction temperature and the thermal resistance from junction to air (i.e., T_A , T_J , θ_{JA}). Exceeding the maximum allowable power dissipation will cause the device operating junction temperature to exceed the maximum +85°C rating. Sustained junction temperatures above +85°C can impact the device reliability.

MIC920

2.0 TYPICAL PERFORMANCE CURVES

Note: The graphs and tables provided following this note are a statistical summary based on a limited number of samples and are provided for informational purposes only. The performance characteristics listed herein are not tested or guaranteed. In some graphs or tables, the data presented may be outside the specified operating range (e.g., outside specified power supply range) and therefore outside the warranted range.

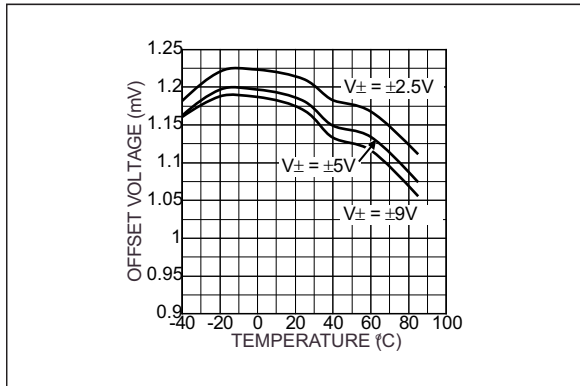

FIGURE 2-1: Offset Voltage vs. Temperature.

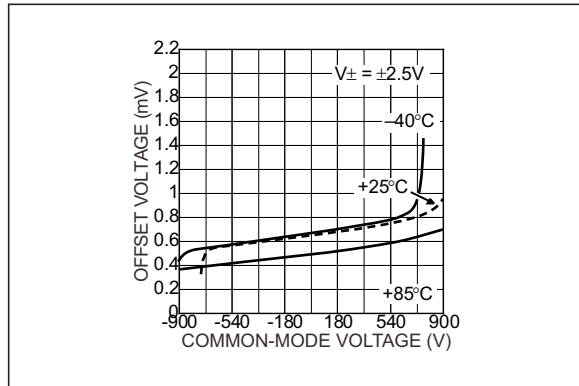

FIGURE 2-4: Offset Voltage vs. Common-Mode Voltage.

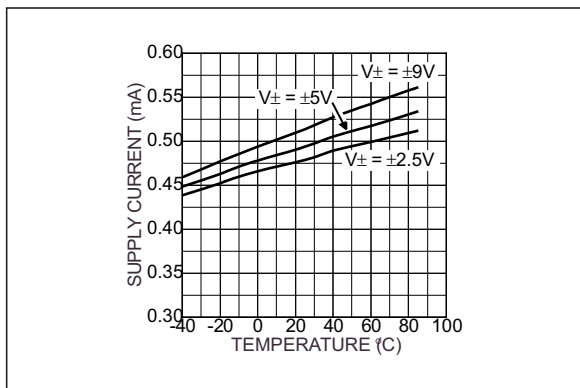

FIGURE 2-2: Supply Current vs. Temperature.

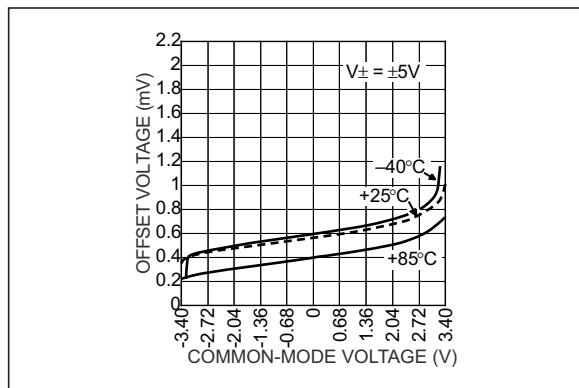

FIGURE 2-5: Offset Voltage vs. Common-Mode Voltage.

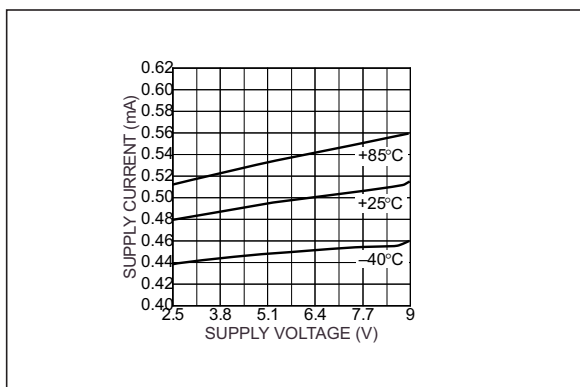

FIGURE 2-3: Supply Current vs. Supply Voltage.

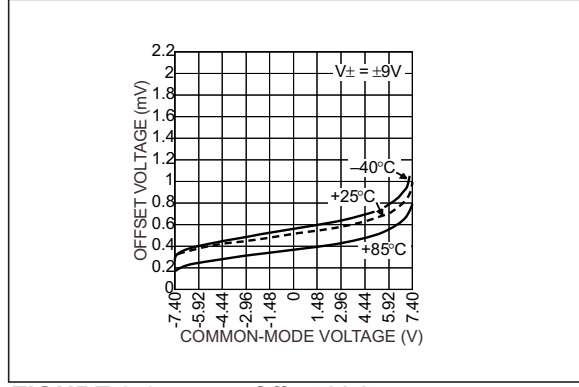

FIGURE 2-6: Offset Voltage vs. Common-Mode Voltage.

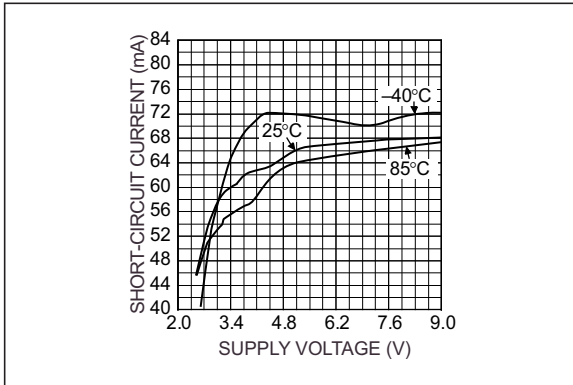

FIGURE 2-7: Short Circuit Current vs. Supply Voltage (Sourcing).

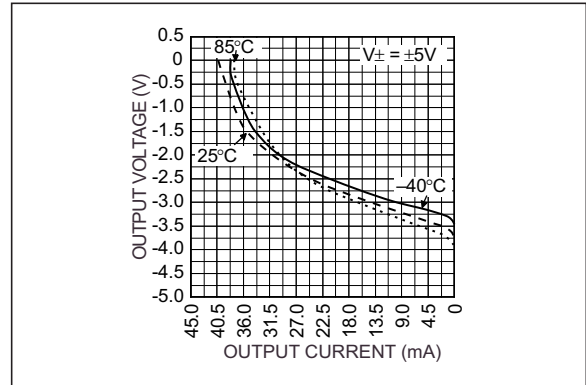

FIGURE 2-10: Output Voltage vs. Output Current (Sinking).

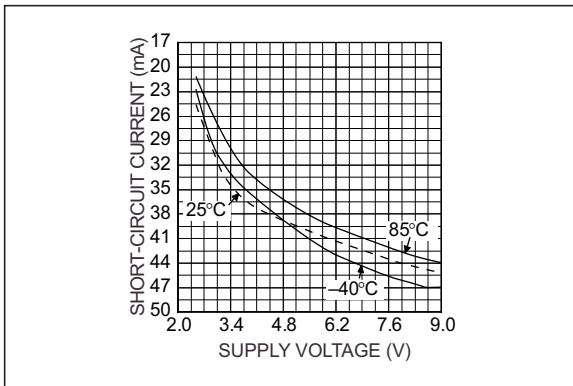

FIGURE 2-8: Short Circuit Current vs. Supply Voltage (Sinking).

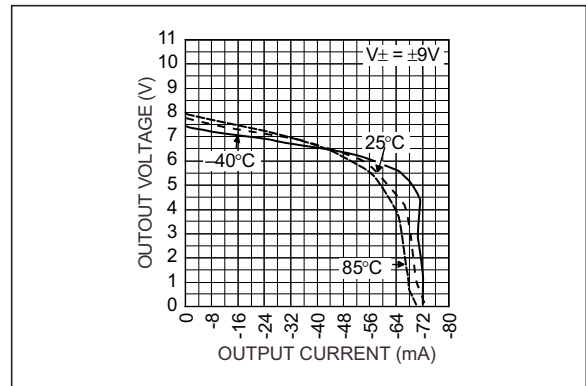

FIGURE 2-11: Output Voltage vs. Output Current (Sourcing).

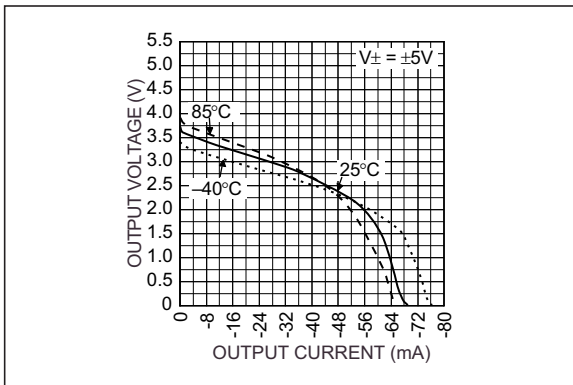

FIGURE 2-9: Output Voltage vs. Output Current (Sourcing).

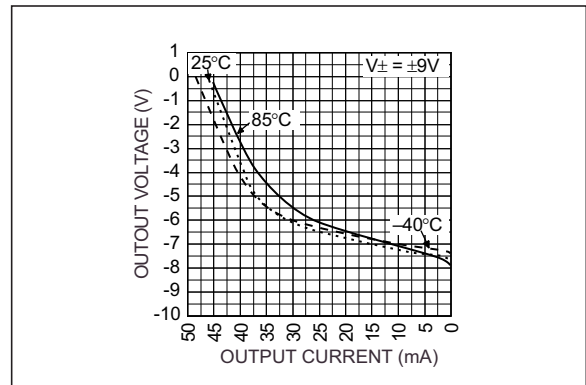

FIGURE 2-12: Output Voltage vs. Output Current (Sinking).

MIC920

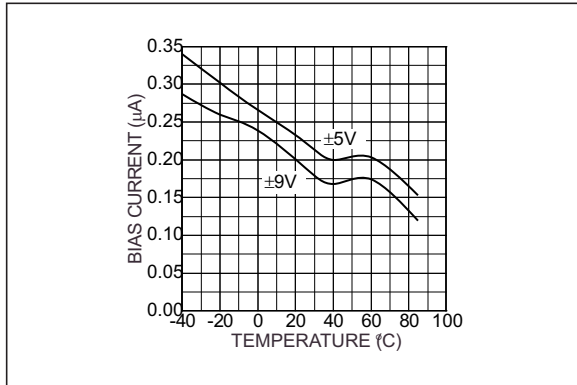

FIGURE 2-13: Bias Current vs. Temperature.

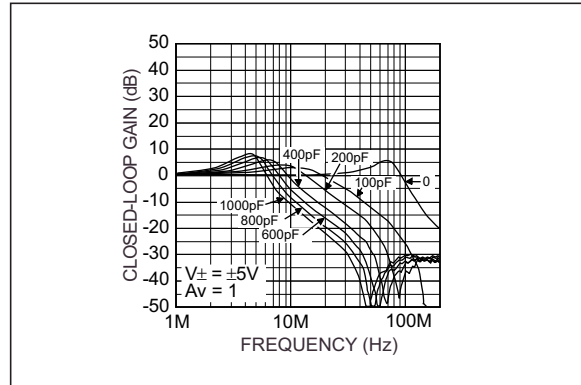

FIGURE 2-16: Closed-Loop Gain vs. Frequency.

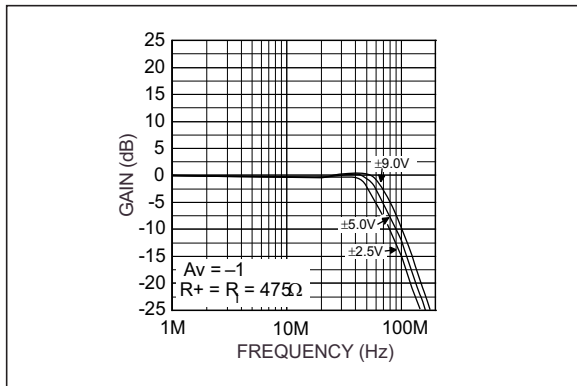

FIGURE 2-14: Closed-Loop Frequency Response.

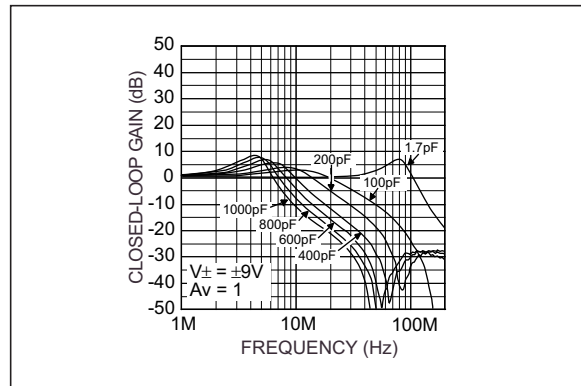

FIGURE 2-17: Closed-Loop Frequency Response.

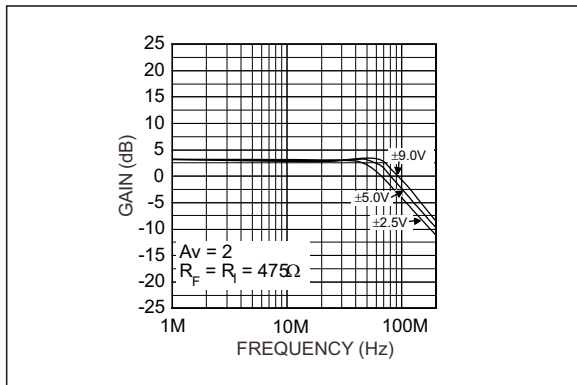

FIGURE 2-15: Closed-Loop Frequency Response.

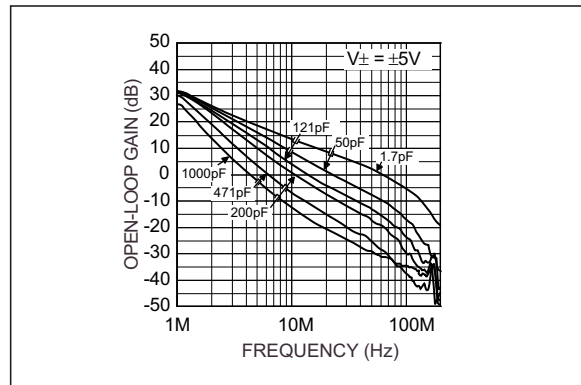

FIGURE 2-18: Open-Loop Gain vs. Frequency.

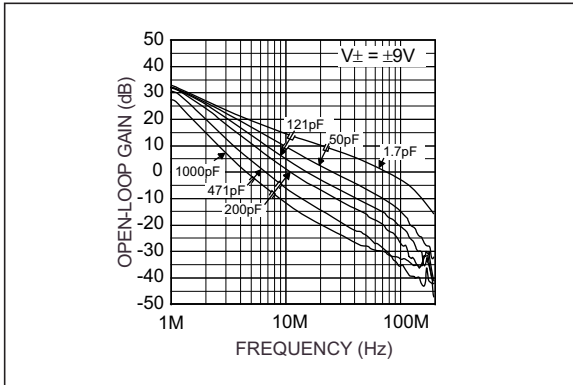

FIGURE 2-19: Open-Loop Gain vs. Frequency.

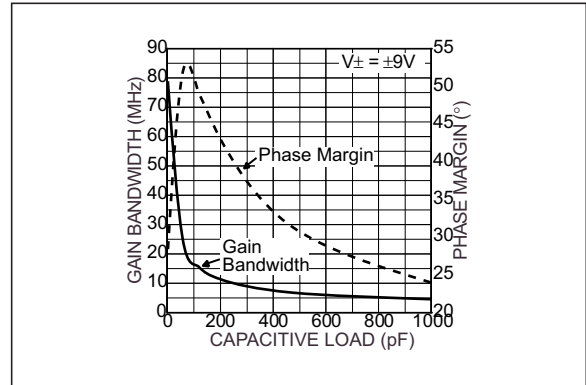

FIGURE 2-22: Gain Bandwidth and Phase Margin vs. Load.

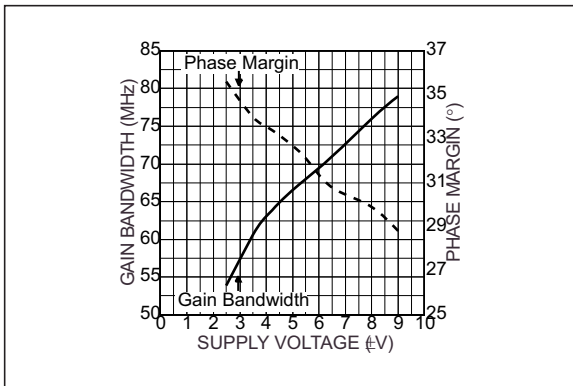

FIGURE 2-20: Gain Bandwidth and Phase Margin vs. Supply Voltage.

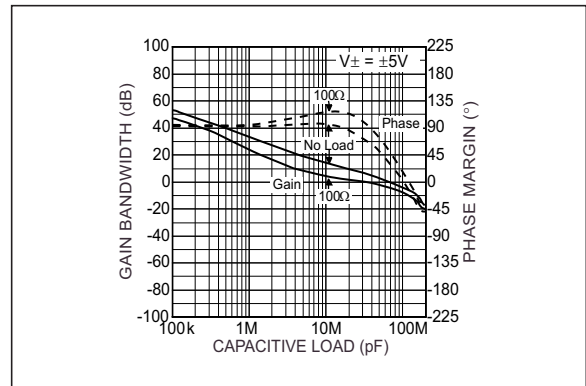

FIGURE 2-23: Open-Loop Frequency Response.

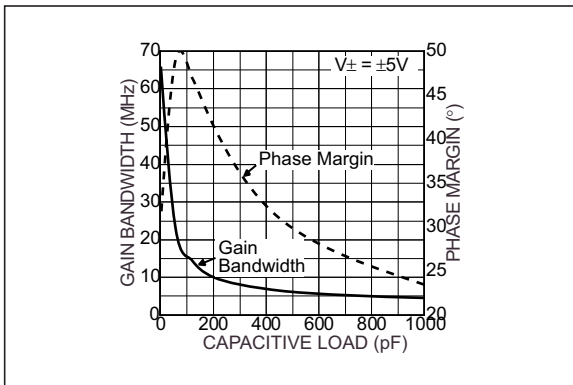

FIGURE 2-21: Gain Bandwidth and Phase Margin vs. Load.

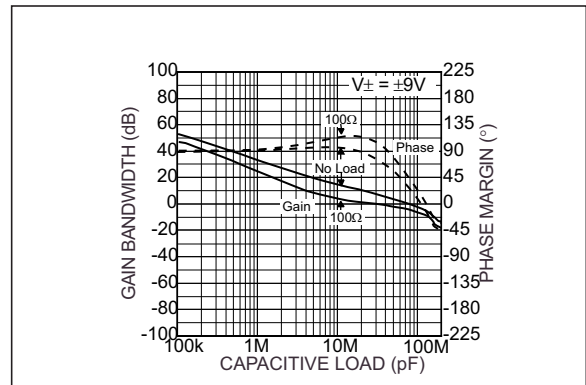

FIGURE 2-24: Open-Loop Frequency Response.

MIC920

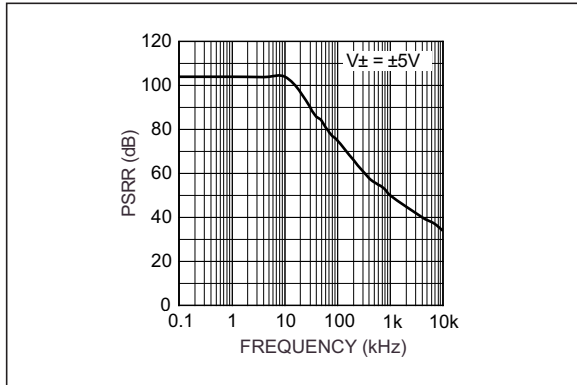

FIGURE 2-25: Positive PSRR vs. Frequency.

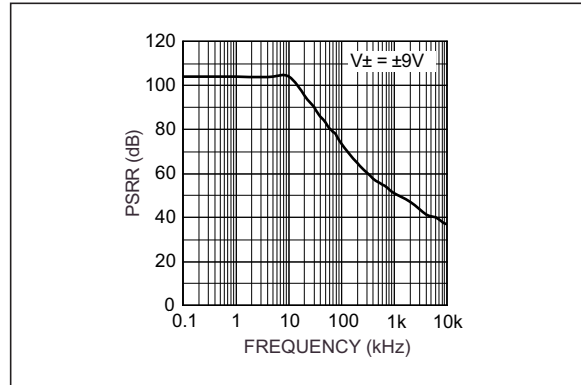

FIGURE 2-28: Negative PSRR vs. Frequency

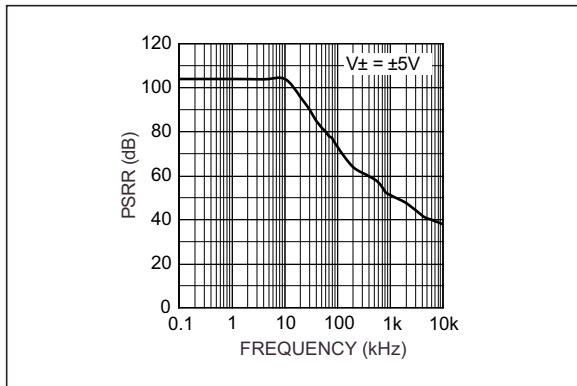

FIGURE 2-26: Negative PSRR vs. Frequency.

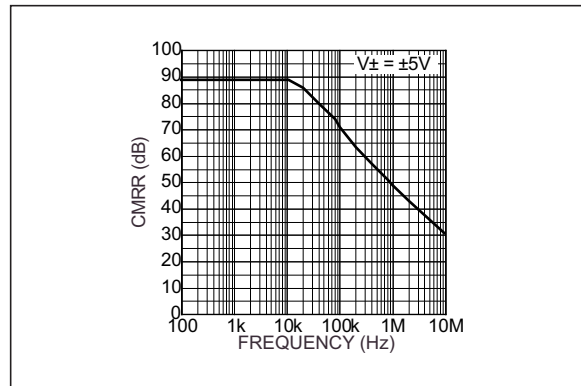

FIGURE 2-29: Common-Mode Rejection Ratio.

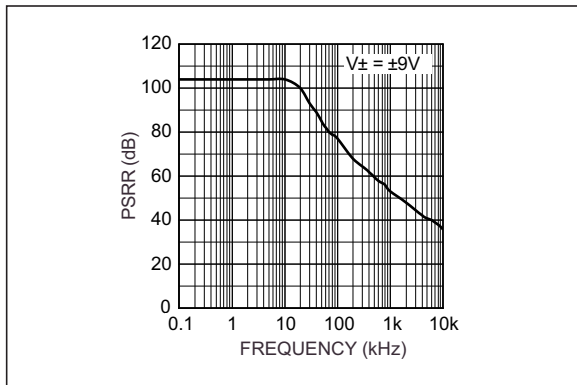

FIGURE 2-27: Positive PSRR vs. Frequency

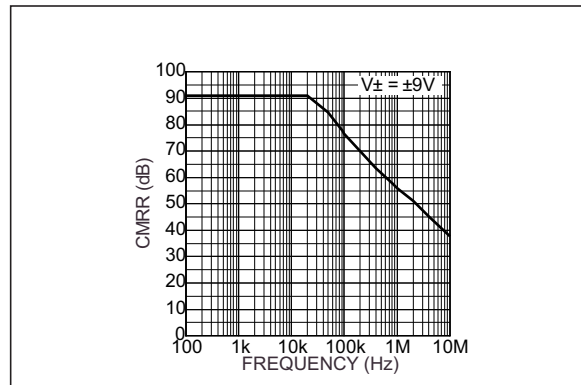

FIGURE 2-30: Common-Mode Rejection Ratio.

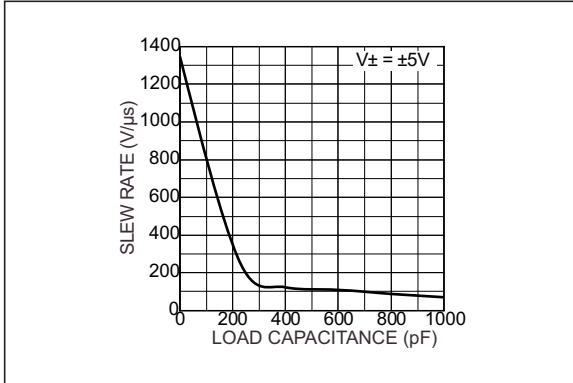

FIGURE 2-31: Positive Slew Rate.

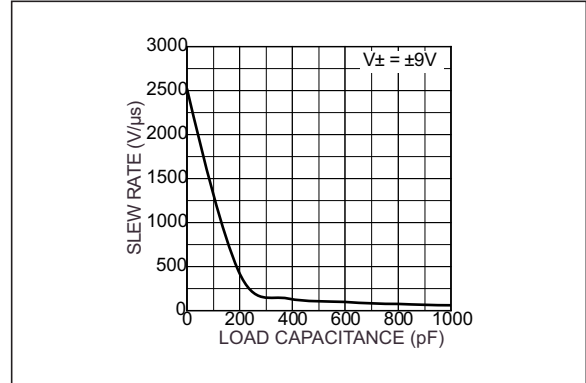

FIGURE 2-34: Negative Slew Rate.

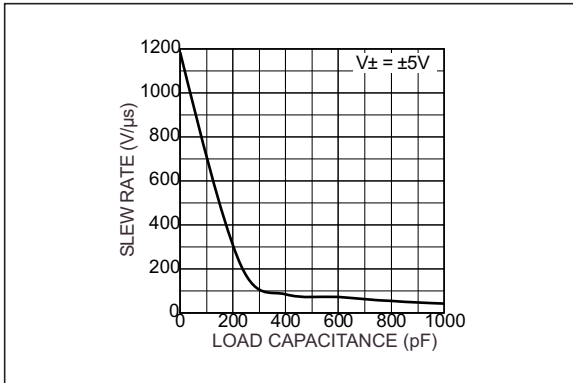

FIGURE 2-32: Negative Slew Rate.

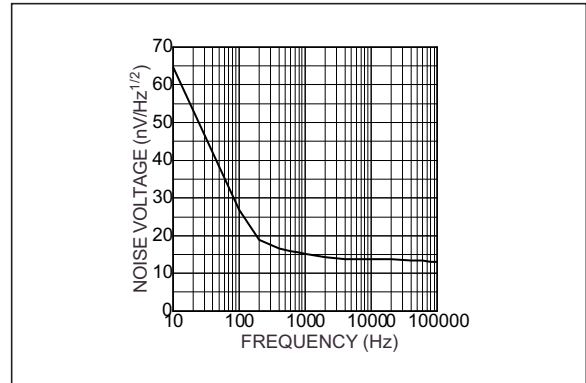

FIGURE 2-35: Voltage Noise Density vs. Frequency.

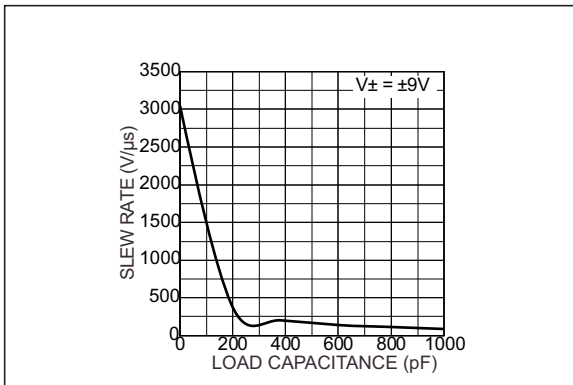

FIGURE 2-33: Positive Slew Rate.

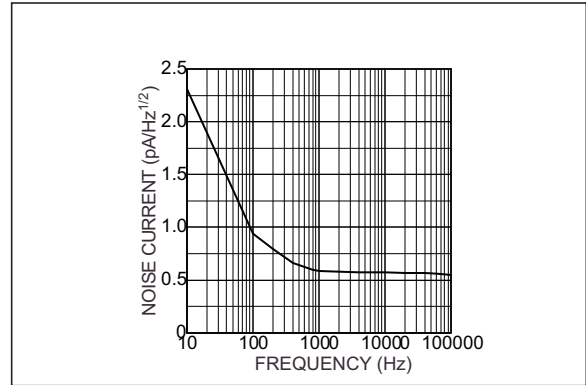

FIGURE 2-36: Current Noise Density vs. Frequency.

MIC920

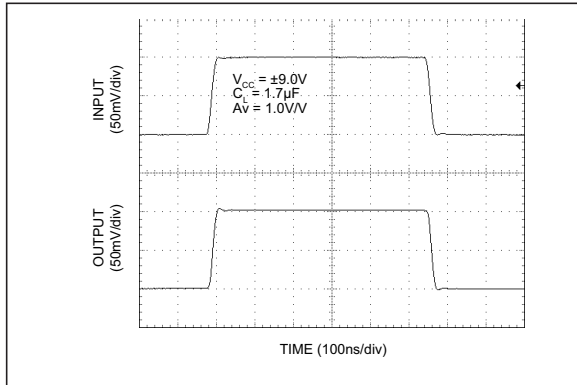

FIGURE 2-37: Small Signal Pulse Response.

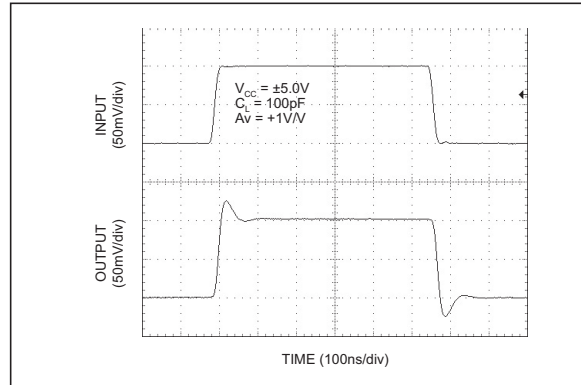

FIGURE 2-40: Small Signal Pulse Response.

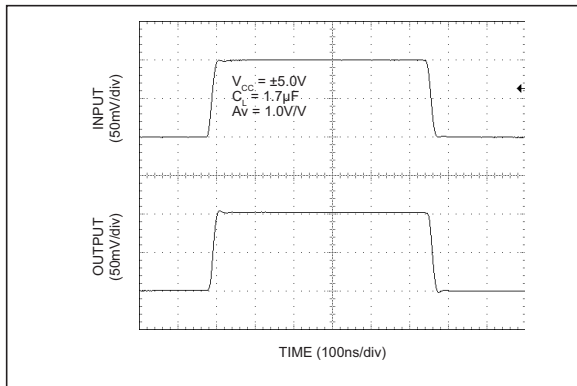

FIGURE 2-38: Small Signal Pulse Response.

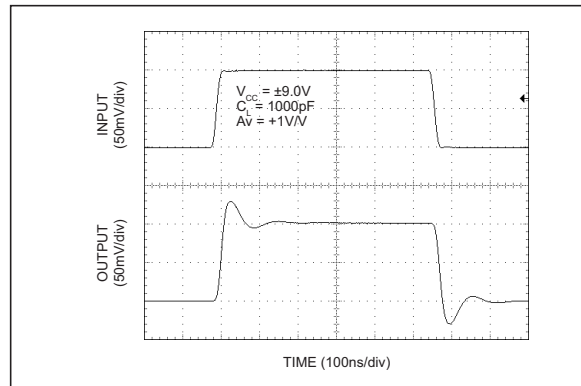

FIGURE 2-41: Small Signal Pulse Response.

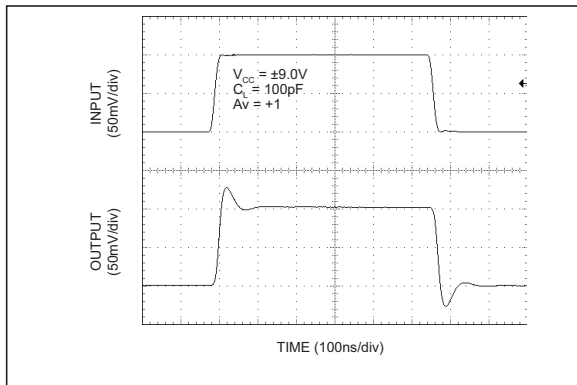

FIGURE 2-39: Small Signal Pulse Response.

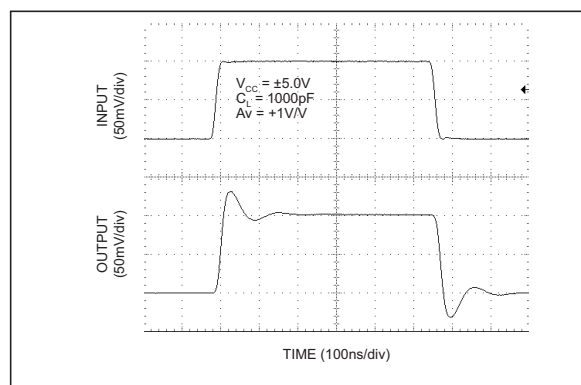

FIGURE 2-42: Small Signal Pulse Response.

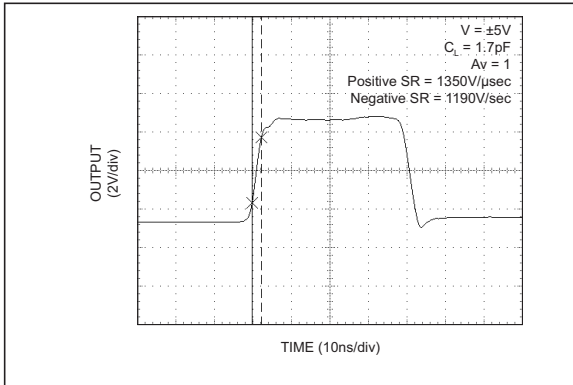

FIGURE 2-43: Large Signal Response.

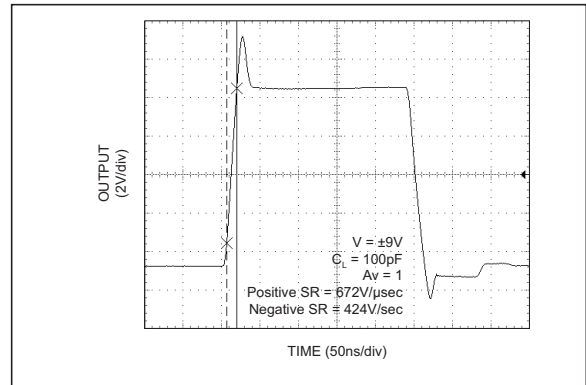

FIGURE 2-46: Large Signal Response.

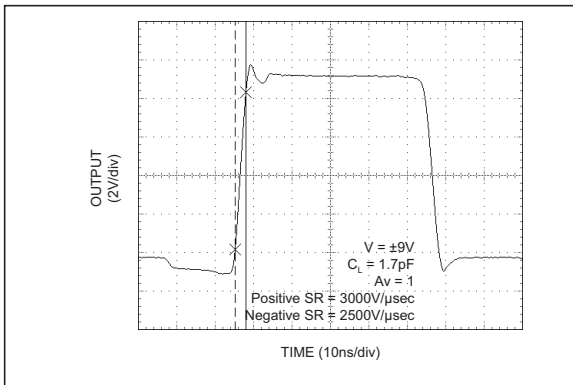

FIGURE 2-44: Large Signal Response.

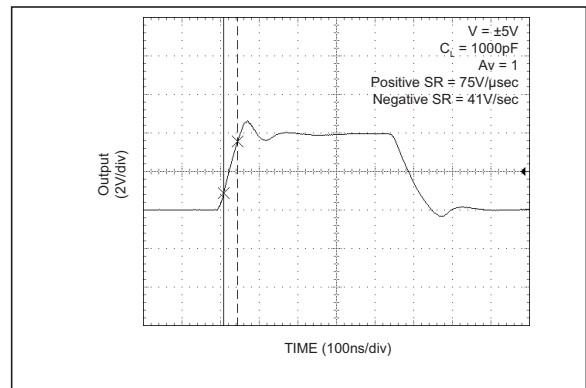

FIGURE 2-47: Large Signal Response.

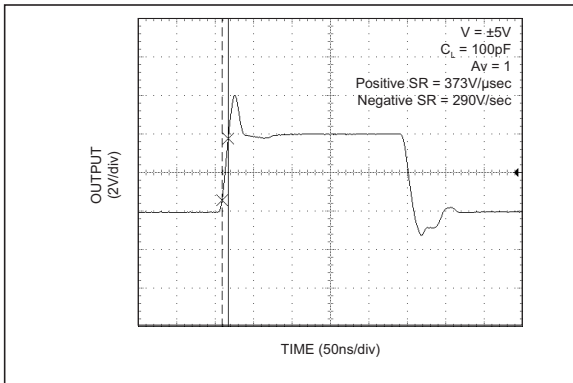

FIGURE 2-45: Large Signal Response.

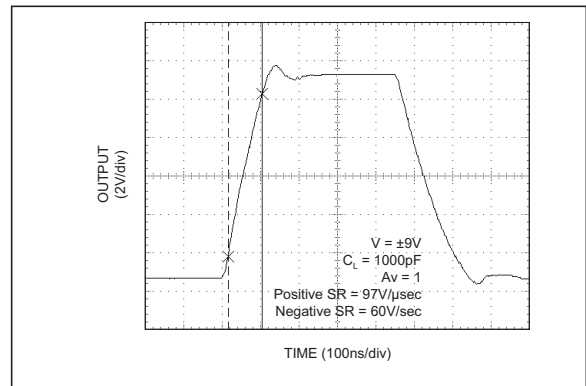

FIGURE 2-48: Large Signal Response.

MIC920

3.0 TEST CIRCUITS

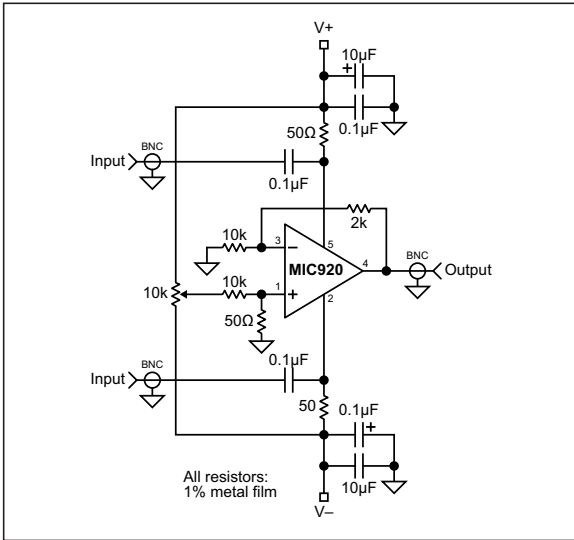

FIGURE 3-1: PSRR vs. Frequency.

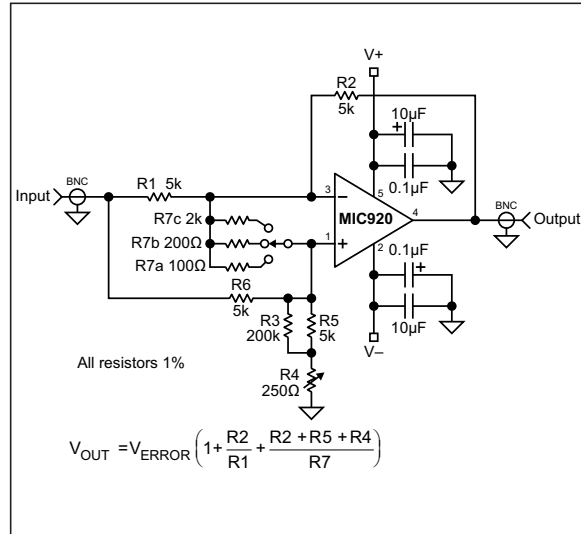

FIGURE 3-3: CMRR vs. Frequency.

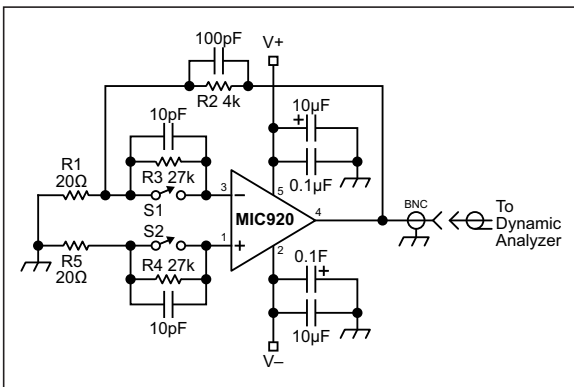

FIGURE 3-2: Noise Measurement.

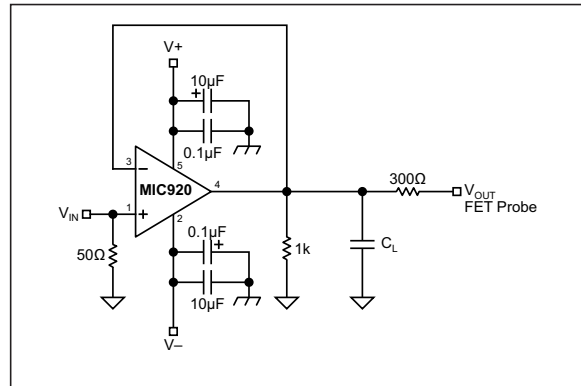

FIGURE 3-4: Closed Loop Frequency Response Measurement.

4.0 PIN DESCRIPTIONS

The descriptions of the pins are listed in [Table 4-1](#).

TABLE 4-1: PIN FUNCTION TABLE

Pin Number	Symbol	Description
1	IN+	Non-inverting input.
2	V-	Negative Supply (Input).
3	IN-	Inverting Input.
4	OUT	Output: Amplifier Output
5	V+	Positive Supply (Input).

5.0 APPLICATION INFORMATION

The MIC920 is a high-speed, voltage-feedback operational amplifier featuring very low supply current and excellent stability. This device is unity gain stable, capable of driving high capacitance loads.

5.1 Driving High Capacitance

The MIC920 is stable when driving high capacitance, making it ideal for driving long coaxial cables or other high-capacitance loads. Most high-speed op amps are only able to drive limited capacitance.

Note: Increasing load capacitance does reduce the speed of the device. In applications where the load capacitance reduces the speed of the op amp to an unacceptable level, the effect of the load capacitance can be reduced by adding a small resistor (<100Ω) in series with the output.

5.2 Feedback Resistor Selection

Conventional op amp gain configurations and resistor selection apply, the MIC920 is NOT a current feedback device.

Also, for minimum peaking, the feedback resistor should have low parasitic capacitance, usually 470Ω is ideal. To use the part as a follower, the output should be connected to input via a short wire.

5.3 Layout Considerations

All high speed devices require careful PCB layout. The following guidelines should be observed: Capacitance, particularly on the two inputs pins will degrade performance; avoid large copper traces to the inputs. Keep the output signal away from the inputs and use a ground plane.

It is important to ensure adequate supply bypassing capacitors are located close to the device.

5.4 Power Supply Bypassing

Regular supply bypassing techniques are recommended.

A 10 μF capacitor in parallel with a 0.1 μF capacitor on both the positive and negative supplies are ideal. For best performance all bypassing capacitors should be located as close to the op amp as possible and all capacitors should be low ESL (equivalent series inductance), ESR (equivalent series resistance). Surface-mount ceramic capacitors are ideal.

5.5 Thermal Considerations

The SC70-5 package, like all small packages, have a high thermal resistance. It is important to ensure the IC does not exceed the maximum operating junction (die) temperature of 85°C. The part can be operated up to

the absolute maximum temperature rating of 125°C, but between 85°C and 125°C performance will degrade, in particular CMRR will reduce.

An MIC920 with no load, dissipates power equal to the quiescent supply current x supply voltage.

EQUATION 5-1:

$$P_{D(no\ load)} = (V_{V+} - V_{V-})I_S$$

When a load is added, the additional power is dissipated in the output stage of the op amp. The power dissipated in the device is a function of supply voltage, output voltage and output current.

EQUATION 5-2:

$$P_{D(output\ stage)} = (V_{V+} - V_{OUT})$$

$$P_{D(Total)} = P_{D(no\ load)} + P_{D(output\ stage)}$$

Ensure the total power dissipated in the device is no greater than the thermal capacity of the package. The SC70-5 package has a thermal resistance of 450°C/W.

EQUATION 5-3:

$$P_{D(max)} = \frac{T_{J(max)} - T_{A(max)}}{450^{\circ}C/W}$$

6.0 PACKAGING INFORMATION

6.1 Package Marking Information

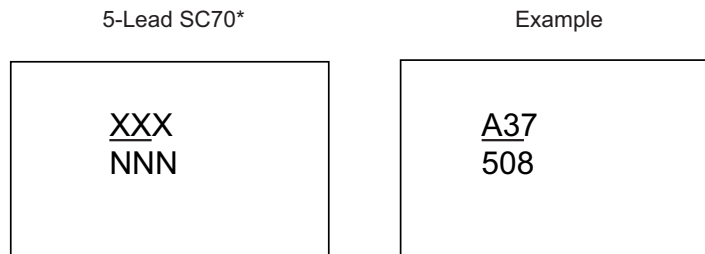

<p>Legend:</p> <ul style="list-style-type: none"> XX...X Product code or customer-specific information Y Year code (last digit of calendar year) YY Year code (last 2 digits of calendar year) WW Week code (week of January 1 is week '01') NNN Alphanumeric traceability code (e3) Pb-free JEDEC® designator for Matte Tin (Sn) * This package is Pb-free. The Pb-free JEDEC designator (e3) can be found on the outer packaging for this package. •, ▲, ▼ Pin one index is identified by a dot, delta up, or delta down (triangle mark).
<p>Note: In the event the full Microchip part number cannot be marked on one line, it will be carried over to the next line, thus limiting the number of available characters for customer-specific information. Package may or may not include the corporate logo.</p> <p>Underbar ($\underline{\quad}$) and/or Overbar ($\overline{\quad}$) symbol may not be to scale.</p>

MIC920

5-Lead SC70 (C5) Package Outline and Recommended Land Pattern

TITLE

5 LEAD SC70 PACKAGE OUTLINE & RECOMMENDED LAND PATTERN

DRAWING #	SC70-5LD-PL-2	UNIT	MM
-----------	---------------	------	----

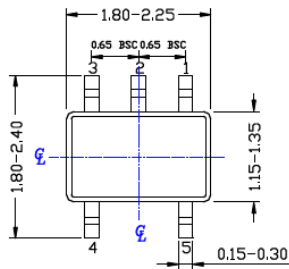

TOP VIEW

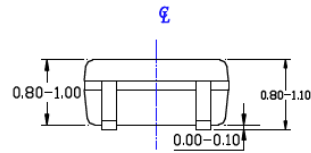

SIDE VIEW

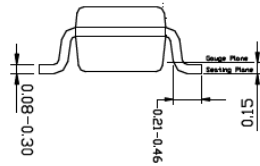

END VIEW

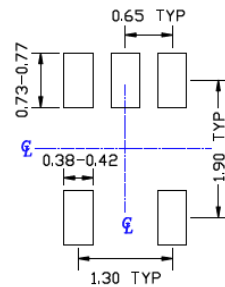

RECOMMENDED LAND PATTERN

NOTE:

1. ALL DIMENSIONS ARE IN MILLIMETERS.
2. DIMENSIONS ARE INCLUSIVE OF PLATING.
3. DIMENSIONS ARE EXCLUSIVE OF MOLD FLASH & METAL BURR.

Note: For the most current package drawings, please see the Microchip Packaging Specification located at <http://www.microchip.com/packaging>.

APPENDIX A: REVISION HISTORY

Revision A (October 2019)

- Converted Micrel document MIC920 to Microchip data sheet template DS20006268A.
- Minor text changes throughout.

MIC920

NOTES:

PRODUCT IDENTIFICATION SYSTEM

To order or obtain information, e.g., on pricing or delivery, contact your local Microchip representative or sales office.

<u>PART NO.</u>		X	XX	-XX
Device	Temperature	Package	Media Type	
Device:	MIC920:	80 MHz Low-Power SC70 Op Amp		
Temperature:	Y =	-40°C to +85°C		
Package:	C5 =	5-Lead SC70		
Media Type:	TR =	3,000/Reel		

Examples:

a) MIC920YC5-TR: 80 MHz Low-Power SC-70 Op Amp, -40°C to +85°C Ambient Temperature Range, 5-Lead SC70 Package, 3,000/Reel

Note 1: Tape and Reel identifier only appears in the catalog part number description. This identifier is used for ordering purposes and is not printed on the device package. Check with your Microchip Sales Office for package availability with the Tape and Reel option.

MIC920

NOTES:

Note the following details of the code protection feature on Microchip devices:

- Microchip products meet the specification contained in their particular Microchip Data Sheet.
- Microchip believes that its family of products is one of the most secure families of its kind on the market today, when used in the intended manner and under normal conditions.
- There are dishonest and possibly illegal methods used to breach the code protection feature. All of these methods, to our knowledge, require using the Microchip products in a manner outside the operating specifications contained in Microchip's Data Sheets. Most likely, the person doing so is engaged in theft of intellectual property.
- Microchip is willing to work with the customer who is concerned about the integrity of their code.
- Neither Microchip nor any other semiconductor manufacturer can guarantee the security of their code. Code protection does not mean that we are guaranteeing the product as “unbreakable.”

Code protection is constantly evolving. We at Microchip are committed to continuously improving the code protection features of our products. Attempts to break Microchip's code protection feature may be a violation of the Digital Millennium Copyright Act. If such acts allow unauthorized access to your software or other copyrighted work, you may have a right to sue for relief under that Act.

Information contained in this publication regarding device applications and the like is provided only for your convenience and may be superseded by updates. It is your responsibility to ensure that your application meets with your specifications. MICROCHIP MAKES NO REPRESENTATIONS OR WARRANTIES OF ANY KIND WHETHER EXPRESS OR IMPLIED, WRITTEN OR ORAL, STATUTORY OR OTHERWISE, RELATED TO THE INFORMATION, INCLUDING BUT NOT LIMITED TO ITS CONDITION, QUALITY, PERFORMANCE, MERCHANTABILITY OR FITNESS FOR PURPOSE. Microchip disclaims all liability arising from this information and its use. Use of Microchip devices in life support and/or safety applications is entirely at the buyer's risk, and the buyer agrees to defend, indemnify and hold harmless Microchip from any and all damages, claims, suits, or expenses resulting from such use. No licenses are conveyed, implicitly or otherwise, under any Microchip intellectual property rights unless otherwise stated.

Trademarks

The Microchip name and logo, the Microchip logo, Adaptec, AnyRate, AVR, AVR logo, AVR Freaks, BesTime, BitCloud, chipKIT, chipKIT logo, CryptoMemory, CryptoRF, dsPIC, FlashFlex, flexPWR, HELDO, IGLOO, JukeBlox, KeeLoq, Klear, LANCheck, LinkMD, maXStylus, maXTouch, MediaLB, megaAVR, Microsemi, Microsemi logo, MOST, MOST logo, MPLAB, OptoLyzer, PackeTime, PIC, picoPower, PICSTART, PIC32 logo, PolarFire, Prochip Designer, QTouch, SAM-BA, SenGenuity, SpyNIC, SST, SST Logo, SuperFlash, Symmetricom, SyncServer, Tachyon, TempTrackr, TimeSource, tinyAVR, UNI/O, Vectron, and XMEGA are registered trademarks of Microchip Technology Incorporated in the U.S.A. and other countries.

APT, ClockWorks, The Embedded Control Solutions Company, EtherSynch, FlashTec, Hyper Speed Control, HyperLight Load, IntelliMOS, Libero, motorBench, mTouch, Powermite 3, Precision Edge, ProASIC, ProASIC Plus, ProASIC Plus logo, Quiet-Wire, SmartFusion, SyncWorld, Temux, TimeCesium, TimeHub, TimePictra, TimeProvider, Vite, WinPath, and ZL are registered trademarks of Microchip Technology Incorporated in the U.S.A.

Adjacent Key Suppression, AKS, Analog-for-the-Digital Age, Any Capacitor, AnyIn, AnyOut, BlueSky, BodyCom, CodeGuard, CryptoAuthentication, CryptoAutomotive, CryptoCompanion, CryptoController, dsPICDEM, dsPICDEM.net, Dynamic Average Matching, DAM, ECAN, EtherGREEN, In-Circuit Serial Programming, ICSP, INICnet, Inter-Chip Connectivity, JitterBlocker, KlearNet, KlearNet logo, memBrain, Mindi, MiWi, MPASM, MPF, MPLAB Certified logo, MPLIB, MPLINK, MultiTRAK, NetDetach, Omniscient Code Generation, PICDEM, PICDEM.net, PICKit, PICtail, PowerSmart, PureSilicon, QMatrix, REAL ICE, Ripple Blocker, SAM-ICE, Serial Quad I/O, SMART-I.S., SQI, SuperSwitcher, SuperSwitcher II, Total Endurance, TSHARC, USBCheck, VariSense, ViewSpan, WiperLock, Wireless DNA, and ZENA are trademarks of Microchip Technology Incorporated in the U.S.A. and other countries.

SQTP is a service mark of Microchip Technology Incorporated in the U.S.A.

The Adaptec logo, Frequency on Demand, Silicon Storage Technology, and Symmcom are registered trademarks of Microchip Technology Inc. in other countries.

GestIC is a registered trademark of Microchip Technology Germany II GmbH & Co. KG, a subsidiary of Microchip Technology Inc., in other countries.

All other trademarks mentioned herein are property of their respective companies.

© 2019, Microchip Technology Incorporated, All Rights Reserved.

ISBN: 978-1-5224-5206-5

For information regarding Microchip's Quality Management Systems, please visit www.microchip.com/quality.



MICROCHIP

Worldwide Sales and Service

AMERICAS

Corporate Office
2355 West Chandler Blvd.
Chandler, AZ 85224-6199
Tel: 480-792-7200
Fax: 480-792-7277
Technical Support:
<http://www.microchip.com/support>
Web Address:
www.microchip.com

Atlanta

Duluth, GA
Tel: 678-957-9614
Fax: 678-957-1455

Austin, TX

Tel: 512-257-3370

Boston

Westborough, MA
Tel: 774-760-0087
Fax: 774-760-0088

Chicago

Itasca, IL
Tel: 630-285-0071
Fax: 630-285-0075

Dallas

Addison, TX
Tel: 972-818-7423
Fax: 972-818-2924

Detroit

Novi, MI
Tel: 248-848-4000

Houston, TX

Tel: 281-894-5983

Indianapolis

Noblesville, IN
Tel: 317-773-8323
Fax: 317-773-5453
Tel: 317-536-2380

Los Angeles

Mission Viejo, CA
Tel: 949-462-9523
Fax: 949-462-9608
Tel: 951-273-7800

Raleigh, NC

Tel: 919-844-7510

New York, NY

Tel: 631-435-6000

San Jose, CA

Tel: 408-735-9110
Tel: 408-436-4270

Canada - Toronto

Tel: 905-695-1980
Fax: 905-695-2078

ASIA/PACIFIC

Australia - Sydney
Tel: 61-2-9868-6733

China - Beijing
Tel: 86-10-8569-7000

China - Chengdu
Tel: 86-28-8665-5511

China - Chongqing
Tel: 86-23-8980-9588

China - Dongguan
Tel: 86-769-8702-9880

China - Guangzhou
Tel: 86-20-8755-8029

China - Hangzhou
Tel: 86-571-8792-8115

China - Hong Kong SAR
Tel: 852-2943-5100

China - Nanjing
Tel: 86-25-8473-2460

China - Qingdao
Tel: 86-532-8502-7355

China - Shanghai
Tel: 86-21-3326-8000

China - Shenyang
Tel: 86-24-2334-2829

China - Shenzhen
Tel: 86-755-8864-2200

China - Suzhou
Tel: 86-186-6233-1526

China - Wuhan
Tel: 86-27-5980-5300

China - Xian
Tel: 86-29-8833-7252

China - Xiamen
Tel: 86-592-2388138

China - Zhuhai
Tel: 86-756-3210040

ASIA/PACIFIC

India - Bangalore
Tel: 91-80-3090-4444

India - New Delhi
Tel: 91-11-4160-8631

India - Pune
Tel: 91-20-4121-0141

Japan - Osaka
Tel: 81-6-6152-7160

Japan - Tokyo
Tel: 81-3-6880-3770

Korea - Daegu
Tel: 82-53-744-4301

Korea - Seoul
Tel: 82-2-554-7200

Malaysia - Kuala Lumpur
Tel: 60-3-7651-7906

Malaysia - Penang
Tel: 60-4-227-8870

Philippines - Manila
Tel: 63-2-634-9065

Singapore
Tel: 65-6334-8870

Taiwan - Hsin Chu
Tel: 886-3-577-8366

Taiwan - Kaohsiung
Tel: 886-7-213-7830

Taiwan - Taipei
Tel: 886-2-2508-8600

Thailand - Bangkok
Tel: 66-2-694-1351

Vietnam - Ho Chi Minh
Tel: 84-28-5448-2100

EUROPE

Austria - Wels
Tel: 43-7242-2244-39
Fax: 43-7242-2244-393

Denmark - Copenhagen
Tel: 45-4450-2828
Fax: 45-4485-2829

Finland - Espoo
Tel: 358-9-4520-820

France - Paris
Tel: 33-1-69-53-63-20
Fax: 33-1-69-30-90-79

Germany - Garching
Tel: 49-8931-9700

Germany - Haan
Tel: 49-2129-3766400

Germany - Heilbronn
Tel: 49-7131-72400

Germany - Karlsruhe
Tel: 49-721-625370

Germany - Munich
Tel: 49-89-627-144-0
Fax: 49-89-627-144-44

Germany - Rosenheim
Tel: 49-8031-354-560

Israel - Ra'anana
Tel: 972-9-744-7705

Italy - Milan
Tel: 39-0331-742611
Fax: 39-0331-466781

Italy - Padova
Tel: 39-049-7625286

Netherlands - Drunen
Tel: 31-416-690399
Fax: 31-416-690340

Norway - Trondheim
Tel: 47-7288-4388

Poland - Warsaw
Tel: 48-22-3325737

Romania - Bucharest
Tel: 40-21-407-87-50

Spain - Madrid
Tel: 34-91-708-08-90
Fax: 34-91-708-08-91

Sweden - Gothenberg
Tel: 46-31-704-60-40

Sweden - Stockholm
Tel: 46-8-5090-4654

UK - Wokingham
Tel: 44-118-921-5800
Fax: 44-118-921-5820

X-ON Electronics

Largest Supplier of Electrical and Electronic Components

Click to view similar products for [Operational Amplifiers - Op Amps](#) category:

Click to view products by [Microchip](#) manufacturer:

Other Similar products are found below :

[LM258AYDT](#) [LM358SNG](#) [430227FB](#) [UPC824G2-A](#) [LT1678IS8](#) [042225DB](#) [058184EB](#) [UPC259G2-A](#) [NTE925](#) [AZV358MTR-G1](#)
[AP4310AUMTR-AG1](#) [HA1630D02MMEL-E](#) [HA1630S01LPEL-E](#) [SCY33178DR2G](#) [NJU77806F3-TE1](#) [NCV20034DR2G](#) [LM324EDR2G](#)
[LM2902EDR2G](#) [NTE7155](#) [NTE778S](#) [NTE871](#) [NTE924](#) [NTE937](#) [MCP6V17T-E/MNY](#) [MCP6V19-E/ST](#) [MCP6V36UT-E/LTY](#)
[MXD8011HF](#) [MCP6V17T-E/MS](#) [SCY6358ADR2G](#) [LTC2065HUD#PBF](#) [NJM2904CRB1-TE1](#) [2SD965T-R](#) [RS6332P XK](#) [BDM8551](#)
[BDM321](#) [MD1324](#) [COS8052SR](#) [COS8552SR](#) [COS8554SR](#) [COS2177SR](#) [COS2353SR](#) [COS724TR](#) [ASOPD4580S-R](#) [RS321BKXF](#)
[ADA4097-1HUIZ-RL7](#) [NCV4333DTBR2G](#) [EL5420CRZ-T7A](#) [AS324MTR-E1](#) [AS358MMTR-G1](#) [MCP6491T-ELTY](#)