

500 mA Switch with Ripple Blocker™ Technology

Features

- 1.8V to 3.6V Input Voltage Range
- Active Noise Rejection Over a Wide Frequency Band
 - >60 dB from 40 kHz to 5 MHz
- Rated to 500 mA Output Current
- Current-Limit and Thermal-Limit Protected
- 1.6 mm × 1.6 mm 6-Pin Thin DFN
- Logic-Controlled Enable Pin
- -40°C to +125°C Junction Temperature Range

Applications

- Smartphones
- Tablet PC/Notebooks and Webcams
- Digital Still and Video Cameras
- Video Conferencing
- Barcode Scanners
- Global Positioning Systems
- Automotive and Industrial Applications

General Description

The MIC94305 is an integrated load switch that incorporates Microchip's Ripple Blocker™ active filter technology. The MIC94305 provides high-frequency ripple attenuation (switching noise rejection) for applications where switching noise cannot be tolerated by sensitive downstream circuits, such as RF applications. A low voltage logic enable pin disconnects the pass element and puts the MIC94305 in a low current shutdown state when disabled.

The MIC94305 operates from an input voltage of 1.8V to 3.6V, allowing true load switching of low voltage power rails in any electronic device. The output voltage (V_{OUT}) is set at a fixed drop (typically 170 mV) from the input voltage ($V_{OUT} = V_{IN} - 170 \text{ mV}$). This maintains high efficiency independent of given load conditions and currents.

The MIC94305 is packaged in a 6-pin 1.6 mm x 1.6 mm Thin DFN package and has a junction operating temperature range of -40°C to +125°C.

Package Type

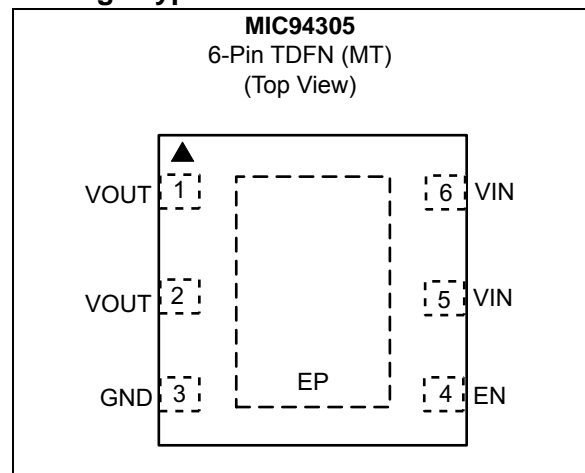

MIC94305

Typical Application Circuit

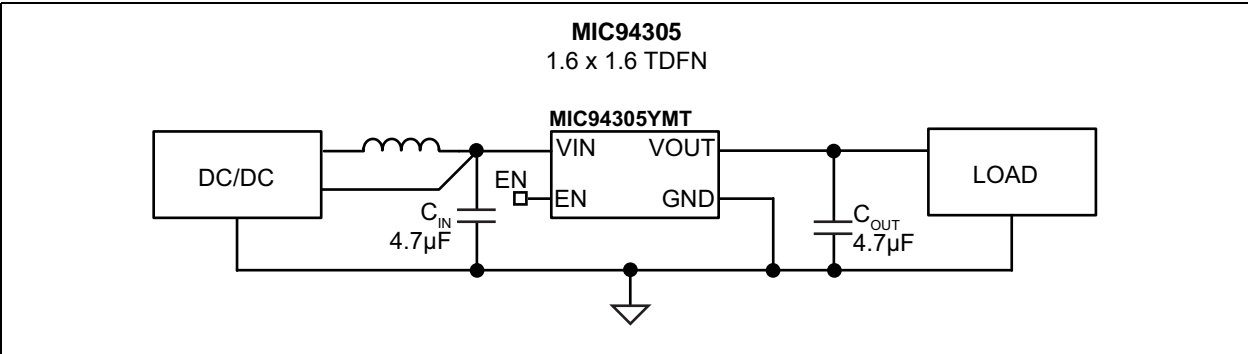

Functional Block Diagram

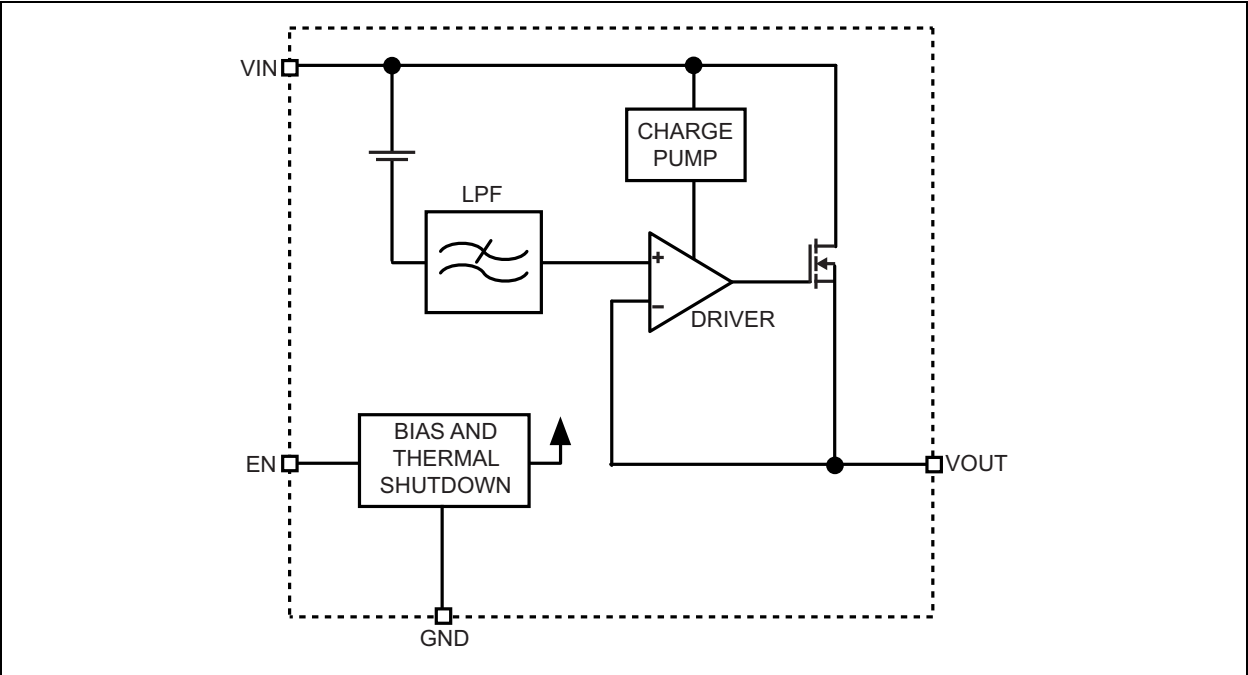

1.0 ELECTRICAL CHARACTERISTICS

Absolute Maximum Ratings †

Input Voltage (V_{IN})	-0.3V to +4.0V
Output Voltage (V_{OUT})	-0.3V to +4.0V
Enable Voltage (V_{EN})	-0.3V to $V_{IN}+0.3V$ or +4.0V
ESD Rating (Note 1)	+3 kV

Operating Ratings ††

Input Voltage (V_{IN})	+1.8V to +3.6V
Enable Voltage (V_{EN})	0V to V_{IN}

† **Notice:** Stresses above those listed under “Absolute Maximum Ratings” may cause permanent damage to the device. This is a stress rating only and functional operation of the device at those or any other conditions above those indicated in the operational sections of this specification is not intended. Exposure to maximum rating conditions for extended periods may affect device reliability.

†† **Notice:** The device is not guaranteed to function outside its operating ratings.

Note 1: Devices are ESD sensitive. Handling precautions are recommended. Human body model, 1.5 k Ω in series with 100 pF.

ELECTRICAL CHARACTERISTICS

Electrical Characteristics: $V_{IN} = V_{EN} = 3.6V$; $I_{OUT} = 1\text{ mA}$; $C_{OUT} = 4.7\ \mu\text{F}$; $T_A = +25^\circ\text{C}$, **bold** values indicate $-40^\circ\text{C} \leq T_J \leq +125^\circ\text{C}$, unless noted. [Note 1](#)

Parameter	Sym.	Min.	Typ.	Max.	Units	Conditions
Input Voltage	V_{IN}	1.8	—	3.6	V	—
Voltage Drop	V_{DROP}	—	170	250	mV	$V_{IN} - V_{OUT}$, $-40^\circ\text{C} \leq T_J \leq +85^\circ\text{C}$
V_{IN} Ripple Rejection	PSRR	—	45	—	dB	$f = 20\text{ kHz}$, $I_{OUT} = 500\text{ mA}$
		—	55	—		$f = 100\text{ kHz to } 5\text{ MHz}$, $I_{OUT} = 500\text{ mA}$
Total Output Noise	e_N	—	98	—	μV_{RMS}	$f = 10\text{ Hz to } 100\text{ kHz}$
Current Limit	I_{LIM}	530	725	1100	mA	$V_{OUT} = 0V$
Turn-On Time	t_{ON}	—	90	150	μs	EN controlled
Load Regulation	—	—	10	—	mV	100 μA to 100 mA
Ground Current	I_{GND}	—	150	200	μA	$I_{OUT} = 100\ \mu\text{A}$
Shutdown Current	I_{SHDN}	—	0.2	5	μA	$V_{EN} = 0V$
Enable						
Input Logic Low	—	—	—	0.4	V	—
Input Logic High	—	1.0	—	—	V	—
Input Current	I_{IN}	—	0.01	1	μA	—

Note 1: Specification for packaged product only.

MIC94305

TEMPERATURE SPECIFICATIONS

Parameters	Sym.	Min.	Typ.	Max.	Units	Conditions
Temperature Ranges						
Junction Operating Temperature	T_J	-40	—	+125	°C	—
Lead Temperature	—	—	—	+260	°C	Soldering, 10 sec.
Storage Temperature Range	T_S	-65	—	+150	°C	—
Package Thermal Resistances						
Thermal Resistance, TDFN 6-Ld	θ_{JA}	—	92	—	°C/W	—

Note 1: The maximum allowable power dissipation is a function of ambient temperature, the maximum allowable junction temperature and the thermal resistance from junction to air (i.e., T_A , T_J , θ_{JA}). Exceeding the maximum allowable power dissipation will cause the device operating junction temperature to exceed the maximum +125°C rating. Sustained junction temperatures above +125°C can impact the device reliability.

2.0 TYPICAL PERFORMANCE CURVES

Note: The graphs and tables provided following this note are a statistical summary based on a limited number of samples and are provided for informational purposes only. The performance characteristics listed herein are not tested or guaranteed. In some graphs or tables, the data presented may be outside the specified operating range (e.g., outside specified power supply range) and therefore outside the warranted range.

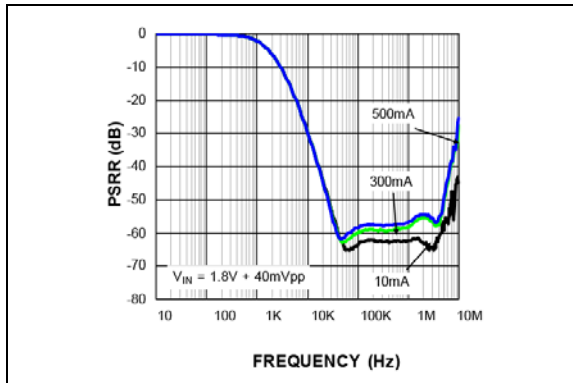

FIGURE 2-1: PSRR $C_{OUT} = 4.7 \mu F$.

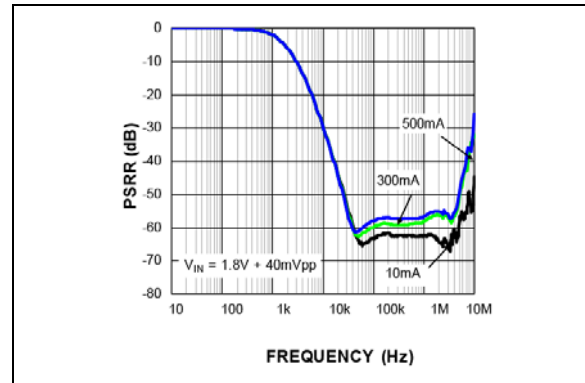

FIGURE 2-4: PSRR $C_{OUT} = 10 \mu F$.

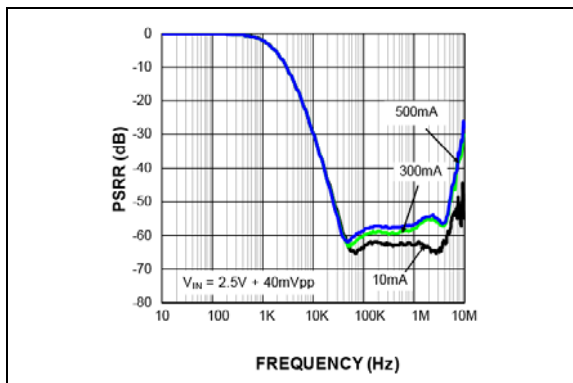

FIGURE 2-2: PSRR $C_{OUT} = 4.7 \mu F$.

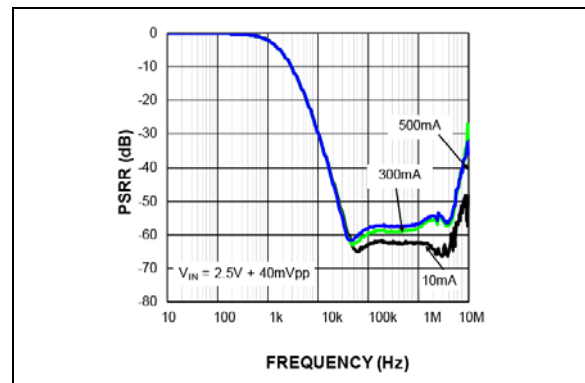

FIGURE 2-5: PSRR $C_{OUT} = 10 \mu F$.

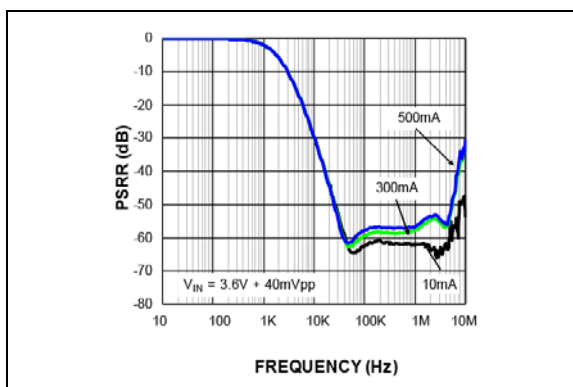

FIGURE 2-3: PSRR $C_{OUT} = 4.7 \mu F$.

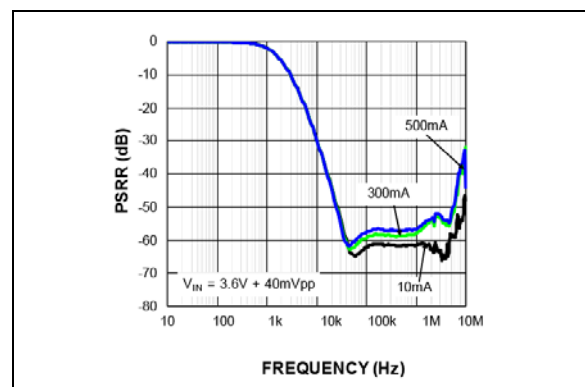

FIGURE 2-6: PSRR $C_{OUT} = 10 \mu F$.

MIC94305

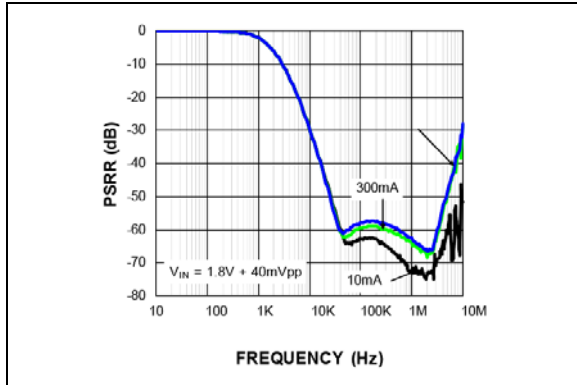

FIGURE 2-7: PSRR $C_{OUT} = 22 \mu F$.

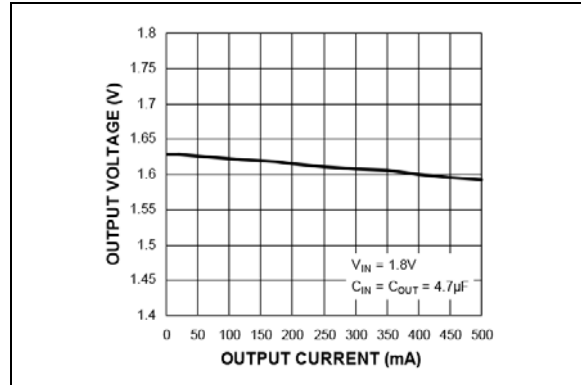

FIGURE 2-10: Output Voltage vs. Output Current.

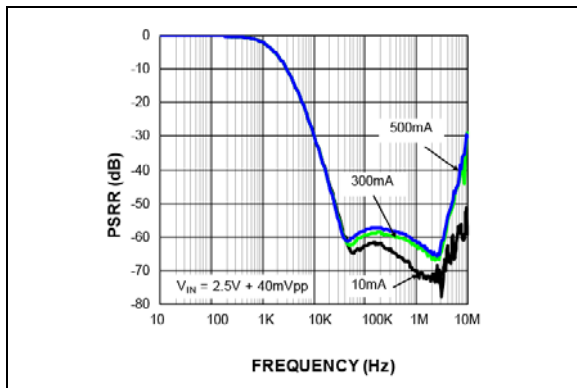

FIGURE 2-8: PSRR $C_{OUT} = 22 \mu F$.

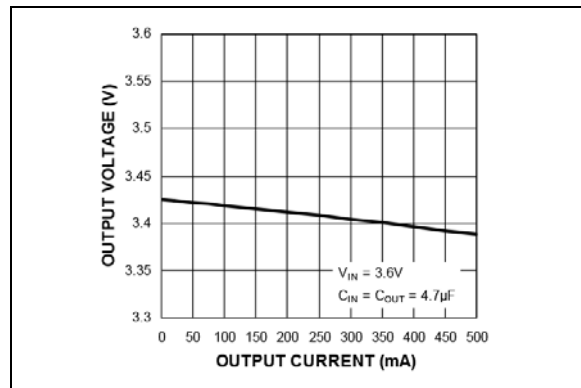

FIGURE 2-11: Output Voltage vs. Output Current.

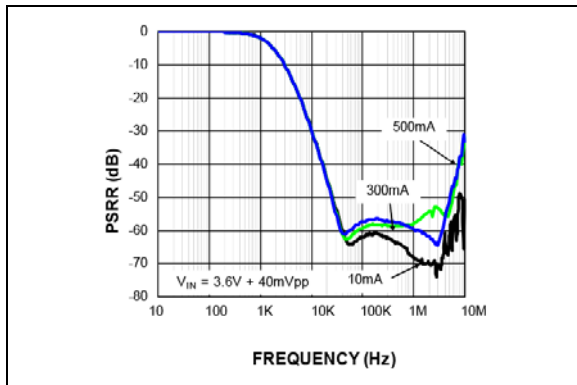

FIGURE 2-9: PSRR $C_{OUT} = 22 \mu F$.

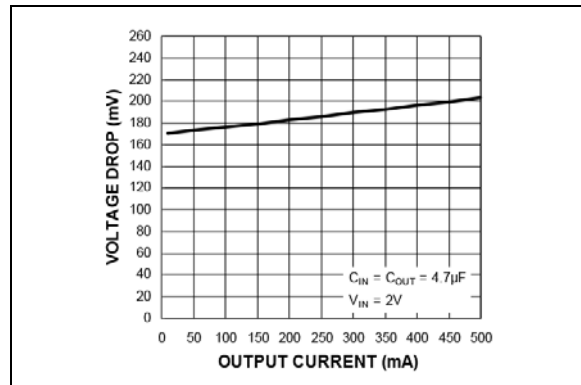

FIGURE 2-12: Voltage Drop vs. Output Current.

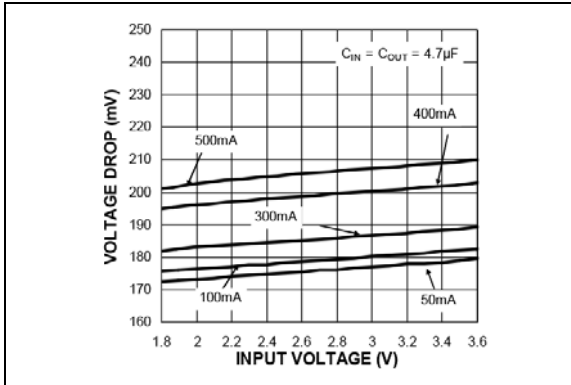

FIGURE 2-13: Voltage Drop vs. Input Current.

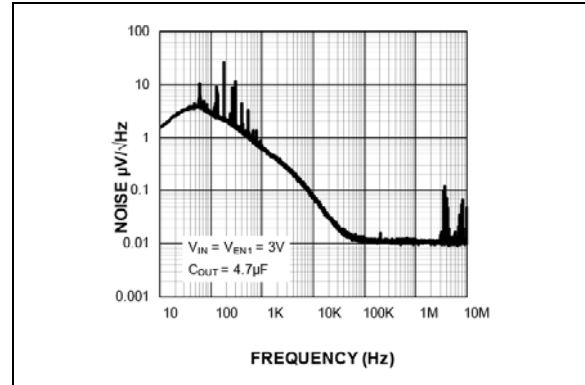

FIGURE 2-16: Output Noise Spectral Density.

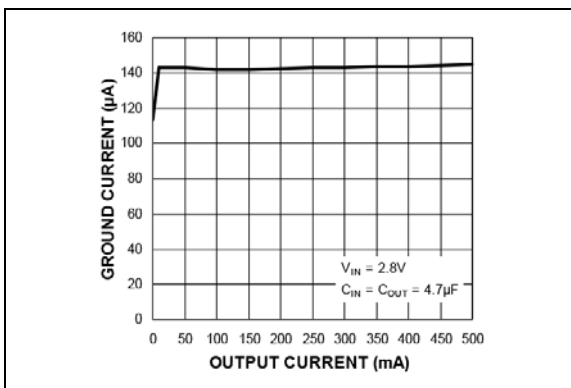

FIGURE 2-14: Ground Current vs. Output Current.

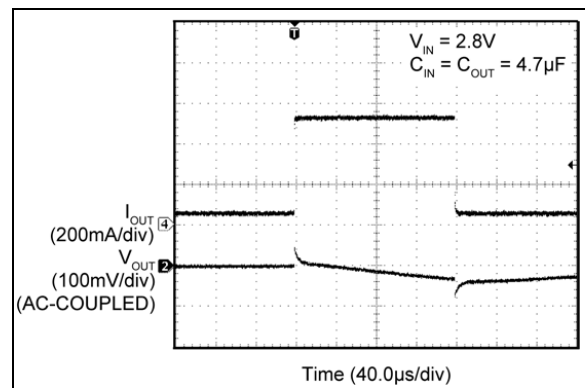

FIGURE 2-17: Load Transient.

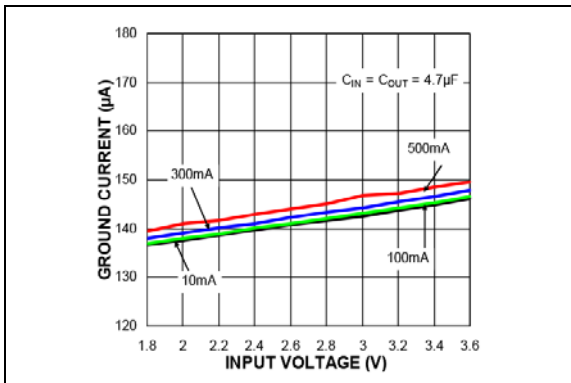

FIGURE 2-15: Ground Current vs. Input Voltage.

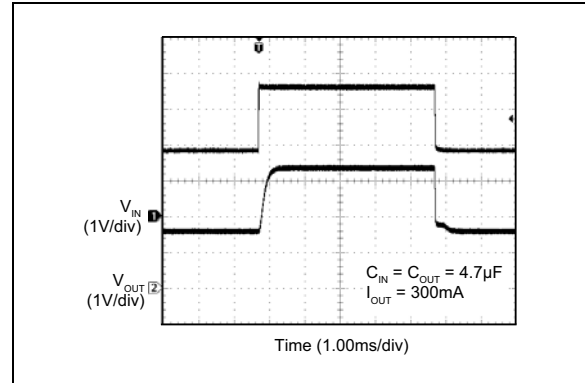

FIGURE 2-18: Line Transient.

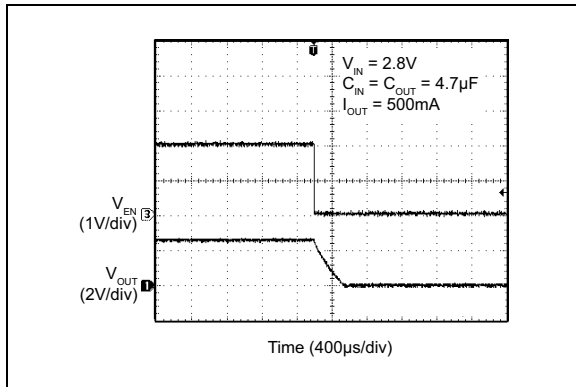

FIGURE 2-19: Enable Turn-Off.

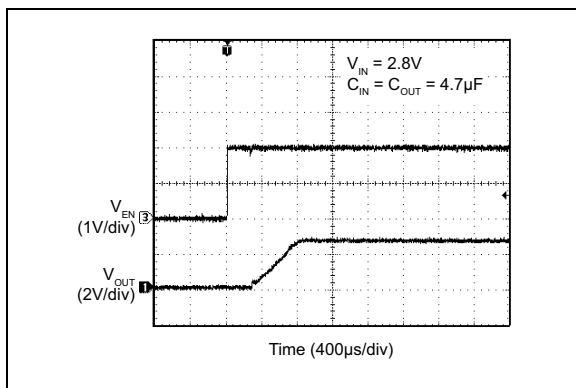

FIGURE 2-20: Enable Turn-On.

3.0 PIN DESCRIPTIONS

The descriptions of the pins are listed in [Table 3-1](#).

TABLE 3-1: PIN FUNCTION TABLE

Pin Number	Pin Name	Description
1, 2	VOUT	Power switch output.
3	GND	Ground.
4	EN	Enable Input. A logic-high signal on this pin enables the part. Logic-low disables the part. Do not leave floating.
5, 6	VIN	Power switch input and chip supply.
ePad	EP	Exposed heatsink pad. Connect to Ground for best thermal performance.

MIC94305

4.0 APPLICATION INFORMATION

The MIC94305 uses Ripple Blocker technology to integrate a load switch with a high-performance active filter. The MIC94305 includes a low voltage logic enable pin and is fully protected from damage caused by fault conditions, offering linear current-limiting and thermal shutdown.

4.1 Input Capacitor

The MIC94305 is a high-performance, high-bandwidth device. An input capacitor of 0.47 μF is required from the input to ground to provide stability. Low-ESR ceramic capacitors provide optimal performance at a minimum of space. Additional high-frequency capacitors, such as small-valued NPO dielectric-type capacitors, help filter out high-frequency noise and are good practice in any RF-based circuit. X5R or X7R dielectrics are recommended for the input capacitor. Y5V dielectrics lose most of their capacitance over temperature and are not recommended.

4.2 Output Capacitance

The MIC94305 requires an output capacitor of 4.7 μF or greater to maintain stability. For optimal ripple rejection performance, a 4.7 μF capacitor is recommended. The design is optimized for use with low-ESR ceramic-chip capacitors. High-ESR capacitors are not recommended because they may cause high-frequency oscillation. The output capacitor can be increased, but performance has been optimized for a 4.7 μF ceramic output capacitor and does not improve significantly with larger capacitance.

X7R/X5R dielectric-type ceramic capacitors are recommended because of their temperature performance. X7R-type capacitors change capacitance by 15% over their operating temperature range and are the most stable type of ceramic capacitors. Z5U and Y5V dielectric capacitors change value by as much as 50% and 60%, respectively, over their operating temperature ranges. If you use a ceramic-chip capacitor with a Y5V dielectric, the value must be much higher than an X7R ceramic capacitor to ensure the same minimum capacitance over the equivalent operating temperature range.

4.3 No-Load Stability

The MIC94305 will remain stable with no load. This is especially important in CMOS RAM keep-alive applications.

4.4 Enable/Shutdown

The MIC94305 comes with an active-high enable pin that allows the Ripple Blocker to be disabled. Forcing the enable pin low disables the MIC94305 and sends it into a “zero” off mode current state. In this state, current

consumed by the MIC94305 goes to nearly zero. Forcing the enable pin high enables the output voltage. The active-high enable pin uses CMOS technology and cannot be left floating; a floating enable pin may cause an indeterminate state on the output.

4.5 Thermal Considerations

The MIC94305 is designed to provide 500 mA of continuous current in a very small package. Maximum ambient operating temperature can be calculated based on the output current and the voltage drop across the part, which is fixed at 170 mV typical, 250 mV worst case. For example if the input voltage is 2.75V, the output voltage is 2.5V, and the output current equals 500 mA. The actual power dissipation of the Ripple Blocker™ can be determined using Equation 4-1:

EQUATION 4-1:

$$P_D = (V_{IN} - V_{OUT})I_{OUT} + V_{IN}I_{GND}$$

Because this device is CMOS and the ground current is typically <100 μA over the load range, the power dissipation contributed by the ground current is <1% and can be ignored for the calculation shown in Equation 4-2.

EQUATION 4-2:

$$P_D = (2.75\text{V} - 2.5\text{V}) \times 500\text{ mA}$$

$$P_D = 0.125\text{ W}$$

To determine the maximum ambient operating temperature of the package, use the junction-to-ambient thermal resistance of the device and the Equation 4-3:

EQUATION 4-3:

$$P_{D(MAX)} = \left(\frac{T_{J(MAX)} - T_A}{\theta_{JA}} \right)$$

Where:

$T_{J(MAX)} = +125^\circ\text{C}$; the max. junction temp. of the die.
 $\theta_{JA} = 92^\circ\text{C/W}$ for the 6-lead TDFN.

Substituting P_D for $P_{D(MAX)}$ and solving for the ambient operating temperature will give the maximum operating conditions for the regulator circuit.

For proper operation, the maximum power dissipation must not be exceeded.

For example, when operating the MIC94305YMT at a 2.75V input voltage and 500 mA load with a minimum footprint layout, the maximum ambient operating temperature T_A can be determined as follows:

EQUATION 4-4:

$$0.125W = (125^{\circ}C - T_A)/(92^{\circ}C/W)$$

$$T_A = 113.5^{\circ}C$$

It follows from this equation that the maximum ambient operating temperature of 113.5°C is allowed in a 1.6 mm x 1.6 mm TDFN package. For a full discussion of heat sinking and thermal effects on voltage regulators, refer to the “Regulator Thermals” section of Microchip’s [Designing with Low-Dropout Voltage Regulators](#) handbook.

MIC94305

5.0 PACKAGING INFORMATION

5.1 Package Marking Information

6-Lead TDFN*

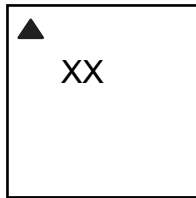

Example

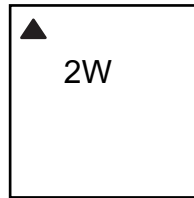

<p>Legend: XX...X Product code or customer-specific information Y Year code (last digit of calendar year) YY Year code (last 2 digits of calendar year) WW Week code (week of January 1 is week '01') NNN Alphanumeric traceability code ⓔ3 Pb-free JEDEC® designator for Matte Tin (Sn) * This package is Pb-free. The Pb-free JEDEC designator (ⓔ3) can be found on the outer packaging for this package.</p> <p>•, ▲, ▼ Pin one index is identified by a dot, delta up, or delta down (triangle mark).</p>
<p>Note: In the event the full Microchip part number cannot be marked on one line, it will be carried over to the next line, thus limiting the number of available characters for customer-specific information. Package may or may not include the corporate logo.</p> <p>Underbar (¯) and/or Overbar (¯) symbol may not be to scale.</p>

6-Lead 1.6 mm x 1.6 mm Thin DFN Package Outline & Recommended Land Pattern

TITLE

6 LEAD TDFN 1.6x1.6mm PACKAGE OUTLINE & RECOMMENDED LAND PATTERN

DRAWING #	TDFN1616-6LD-PL-1	UNIT	MM
-----------	-------------------	------	----

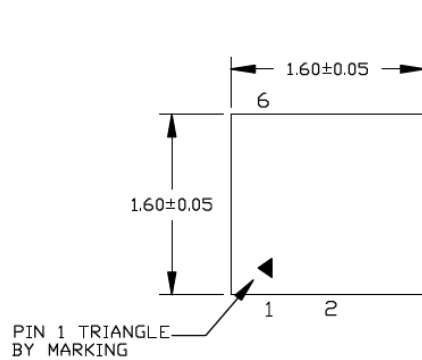

TOP VIEW
NOTE: 1, 2, 3

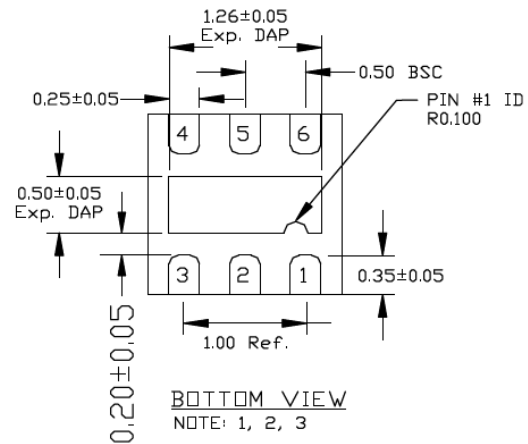

BOTTOM VIEW
NOTE: 1, 2, 3

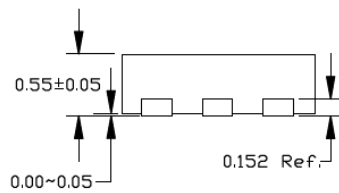

SIDE VIEW
NOTE: 1, 2, 3

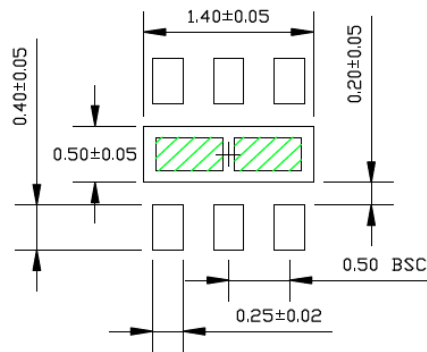

RECOMMENDED LAND PATTERN

NOTE: 4

- NOTE:
1. MAX PACKAGE WARPAGE IS 0.05 MM
 2. MAX ALLOWABLE BURR IS 0.076MM IN ALL DIRECTIONS
 3. PIN #1 IS ON TOP WILL BE LASER MARKED
 4. GREEN SHADED AREA REPRESENT SOLDER STENCIL OPENING (OPTIONAL) FOR IMPROVED THERMAL PERFORMANCE. SIZE: 0.55x0.30MM

Note: For the most current package drawings, please see the Microchip Packaging Specification located at <http://www.microchip.com/packaging>.

MIC94305

NOTES:

APPENDIX A: REVISION HISTORY

Revision A (May 2018)

- Converted Micrel document MIC94305 to Microchip data sheet template DS20006029A.
- Minor grammatical text changes throughout.
- Added soldering conditions to Lead Temperature value in [Temperature Specifications](#).
- Added voltage drop information to [Section 4.5 “Thermal Considerations”](#).

MIC94305

NOTES:

PRODUCT IDENTIFICATION SYSTEM

To order or obtain information, e.g., on pricing or delivery, contact your local Microchip representative or sales office.

Device	<u>X</u>	<u>XX</u>	<u>-XX</u>
Part No.	Junction Temp. Range	Package	Media Type
Device:	MIC94305:	500 mA Switch with Ripple Blocker Technology	
Junction Temperature Range:	Y =	-40°C to +125°C, RoHS-Compliant	
Package:	MT =	6-Lead 1.6 mm x 1.6 mm TDFN	
Media Type:	T5 =	500/Reel	
	TR =	5,000/Reel	

Examples:

a) MIC94305YMT-T5: MIC94305, -40°C to +125°C Temperature Range, 6-Lead TDFN, 500/Reel

b) MIC94305YMT-TR: MIC94305, -40°C to +125°C Temperature Range, 6-Lead TDFN, 5,000/Reel

Note 1: Tape and Reel identifier only appears in the catalog part number description. This identifier is used for ordering purposes and is not printed on the device package. Check with your Microchip Sales Office for package availability with the Tape and Reel option.

MIC94305

NOTES:

Note the following details of the code protection feature on Microchip devices:

- Microchip products meet the specification contained in their particular Microchip Data Sheet.
- Microchip believes that its family of products is one of the most secure families of its kind on the market today, when used in the intended manner and under normal conditions.
- There are dishonest and possibly illegal methods used to breach the code protection feature. All of these methods, to our knowledge, require using the Microchip products in a manner outside the operating specifications contained in Microchip's Data Sheets. Most likely, the person doing so is engaged in theft of intellectual property.
- Microchip is willing to work with the customer who is concerned about the integrity of their code.
- Neither Microchip nor any other semiconductor manufacturer can guarantee the security of their code. Code protection does not mean that we are guaranteeing the product as “unbreakable.”

Code protection is constantly evolving. We at Microchip are committed to continuously improving the code protection features of our products. Attempts to break Microchip's code protection feature may be a violation of the Digital Millennium Copyright Act. If such acts allow unauthorized access to your software or other copyrighted work, you may have a right to sue for relief under that Act.

Information contained in this publication regarding device applications and the like is provided only for your convenience and may be superseded by updates. It is your responsibility to ensure that your application meets with your specifications. MICROCHIP MAKES NO REPRESENTATIONS OR WARRANTIES OF ANY KIND WHETHER EXPRESS OR IMPLIED, WRITTEN OR ORAL, STATUTORY OR OTHERWISE, RELATED TO THE INFORMATION, INCLUDING BUT NOT LIMITED TO ITS CONDITION, QUALITY, PERFORMANCE, MERCHANTABILITY OR FITNESS FOR PURPOSE. Microchip disclaims all liability arising from this information and its use. Use of Microchip devices in life support and/or safety applications is entirely at the buyer's risk, and the buyer agrees to defend, indemnify and hold harmless Microchip from any and all damages, claims, suits, or expenses resulting from such use. No licenses are conveyed, implicitly or otherwise, under any Microchip intellectual property rights unless otherwise stated.

Microchip received ISO/TS-16949:2009 certification for its worldwide headquarters, design and wafer fabrication facilities in Chandler and Tempe, Arizona; Gresham, Oregon and design centers in California and India. The Company's quality system processes and procedures are for its PIC® MCUs and dsPIC® DSCs, KEELoQ® code hopping devices, Serial EEPROMs, microperipherals, nonvolatile memory and analog products. In addition, Microchip's quality system for the design and manufacture of development systems is ISO 9001:2000 certified.

**QUALITY MANAGEMENT SYSTEM
CERTIFIED BY DNV
= ISO/TS 16949 =**

Trademarks

The Microchip name and logo, the Microchip logo, AnyRate, AVR, AVR logo, AVR Freaks, BeaconThings, BitCloud, CryptoMemory, CryptoRF, dsPIC, FlashFlex, flexPWR, Helder, JukeBlox, KEELoQ, KEELoQ logo, Kleer, LANCheck, LINK MD, maXStylus, maXTouch, MediaLB, megaAVR, MOST, MOST logo, MPLAB, OptoLyzer, PIC, picoPower, PICSTART, PIC32 logo, Prochip Designer, QTouch, RightTouch, SAM-BA, SpyNIC, SST, SST Logo, SuperFlash, tinyAVR, UNI/O, and XMEGA are registered trademarks of Microchip Technology Incorporated in the U.S.A. and other countries.

ClockWorks, The Embedded Control Solutions Company, EtherSynch, Hyper Speed Control, HyperLight Load, IntelliMOS, mTouch, Precision Edge, and Quiet-Wire are registered trademarks of Microchip Technology Incorporated in the U.S.A.

Adjacent Key Suppression, AKS, Analog-for-the-Digital Age, Any Capacitor, AnyIn, AnyOut, BodyCom, chipKIT, chipKIT logo, CodeGuard, CryptoAuthentication, CryptoCompanion, CryptoController, dsPICDEM, dsPICDEM.net, Dynamic Average Matching, DAM, ECAN, EtherGREEN, In-Circuit Serial Programming, ICSP, Inter-Chip Connectivity, JitterBlocker, KleerNet, KleerNet logo, Mindi, MiWi, motorBench, MPASM, MPF, MPLAB Certified logo, MPLIB, MPLINK, MultiTRAK, NetDetach, Omniscient Code Generation, PICDEM, PICDEM.net, PICKit, PICtail, PureSilicon, QMatrix, RightTouch logo, REAL ICE, Ripple Blocker, SAM-ICE, Serial Quad I/O, SMART-I.S., SQI, SuperSwitcher, SuperSwitcher II, Total Endurance, TSHARC, USBCheck, VariSense, ViewSpan, WiperLock, Wireless DNA, and ZENA are trademarks of Microchip Technology Incorporated in the U.S.A. and other countries.

SQTP is a service mark of Microchip Technology Incorporated in the U.S.A.

Silicon Storage Technology is a registered trademark of Microchip Technology Inc. in other countries.

GestIC is a registered trademark of Microchip Technology Germany II GmbH & Co. KG, a subsidiary of Microchip Technology Inc., in other countries.

All other trademarks mentioned herein are property of their respective companies.

© 2018, Microchip Technology Incorporated, All Rights Reserved.
ISBN: 978-1-5224-3068-1



MICROCHIP

Worldwide Sales and Service

AMERICAS

Corporate Office
2355 West Chandler Blvd.
Chandler, AZ 85224-6199
Tel: 480-792-7200
Fax: 480-792-7277
Technical Support:
<http://www.microchip.com/support>
Web Address:
www.microchip.com

Atlanta

Duluth, GA
Tel: 678-957-9614
Fax: 678-957-1455

Austin, TX

Tel: 512-257-3370

Boston

Westborough, MA
Tel: 774-760-0087
Fax: 774-760-0088

Chicago

Itasca, IL
Tel: 630-285-0071
Fax: 630-285-0075

Dallas

Addison, TX
Tel: 972-818-7423
Fax: 972-818-2924

Detroit

Novi, MI
Tel: 248-848-4000

Houston, TX

Tel: 281-894-5983

Indianapolis

Noblesville, IN
Tel: 317-773-8323
Fax: 317-773-5453
Tel: 317-536-2380

Los Angeles

Mission Viejo, CA
Tel: 949-462-9523
Fax: 949-462-9608
Tel: 951-273-7800

Raleigh, NC

Tel: 919-844-7510

New York, NY

Tel: 631-435-6000

San Jose, CA

Tel: 408-735-9110
Tel: 408-436-4270

Canada - Toronto

Tel: 905-695-1980
Fax: 905-695-2078

ASIA/PACIFIC

Australia - Sydney
Tel: 61-2-9868-6733

China - Beijing
Tel: 86-10-8569-7000

China - Chengdu
Tel: 86-28-8665-5511

China - Chongqing
Tel: 86-23-8980-9588

China - Dongguan
Tel: 86-769-8702-9880

China - Guangzhou
Tel: 86-20-8755-8029

China - Hangzhou
Tel: 86-571-8792-8115

China - Hong Kong SAR
Tel: 852-2943-5100

China - Nanjing
Tel: 86-25-8473-2460

China - Qingdao
Tel: 86-532-8502-7355

China - Shanghai
Tel: 86-21-3326-8000

China - Shenyang
Tel: 86-24-2334-2829

China - Shenzhen
Tel: 86-755-8864-2200

China - Suzhou
Tel: 86-186-6233-1526

China - Wuhan
Tel: 86-27-5980-5300

China - Xian
Tel: 86-29-8833-7252

China - Xiamen
Tel: 86-592-2388138

China - Zhuhai
Tel: 86-756-3210040

ASIA/PACIFIC

India - Bangalore
Tel: 91-80-3090-4444

India - New Delhi
Tel: 91-11-4160-8631

India - Pune
Tel: 91-20-4121-0141

Japan - Osaka
Tel: 81-6-6152-7160

Japan - Tokyo
Tel: 81-3-6880-3770

Korea - Daegu
Tel: 82-53-744-4301

Korea - Seoul
Tel: 82-2-554-7200

Malaysia - Kuala Lumpur
Tel: 60-3-7651-7906

Malaysia - Penang
Tel: 60-4-227-8870

Philippines - Manila
Tel: 63-2-634-9065

Singapore
Tel: 65-6334-8870

Taiwan - Hsin Chu
Tel: 886-3-577-8366

Taiwan - Kaohsiung
Tel: 886-7-213-7830

Taiwan - Taipei
Tel: 886-2-2508-8600

Thailand - Bangkok
Tel: 66-2-694-1351

Vietnam - Ho Chi Minh
Tel: 84-28-5448-2100

EUROPE

Austria - Wels
Tel: 43-7242-2244-39
Fax: 43-7242-2244-393

Denmark - Copenhagen
Tel: 45-4450-2828
Fax: 45-4485-2829

Finland - Espoo
Tel: 358-9-4520-820

France - Paris
Tel: 33-1-69-53-63-20
Fax: 33-1-69-30-90-79

Germany - Garching
Tel: 49-8931-9700

Germany - Haan
Tel: 49-2129-3766400

Germany - Heilbronn
Tel: 49-7131-67-3636

Germany - Karlsruhe
Tel: 49-721-625370

Germany - Munich
Tel: 49-89-627-144-0
Fax: 49-89-627-144-44

Germany - Rosenheim
Tel: 49-8031-354-560

Israel - Ra'anana
Tel: 972-9-744-7705

Italy - Milan
Tel: 39-0331-742611
Fax: 39-0331-466781

Italy - Padova
Tel: 39-049-7625286

Netherlands - Drunen
Tel: 31-416-690399
Fax: 31-416-690340

Norway - Trondheim
Tel: 47-7289-7561

Poland - Warsaw
Tel: 48-22-3325737

Romania - Bucharest
Tel: 40-21-407-87-50

Spain - Madrid
Tel: 34-91-708-08-90
Fax: 34-91-708-08-91

Sweden - Gothenberg
Tel: 46-31-704-60-40

Sweden - Stockholm
Tel: 46-8-5090-4654

UK - Wokingham
Tel: 44-118-921-5800
Fax: 44-118-921-5820

X-ON Electronics

Largest Supplier of Electrical and Electronic Components

Click to view similar products for [Power Management IC Development Tools](#) category:

Click to view products by [Microchip](#) manufacturer:

Other Similar products are found below :

[EVAL6482H-DISC](#) [EVAL-AD5522EBUZ](#) [EVAL-ADM1060EBZ](#) [EVAL-ADM1073MEBZ](#) [EVAL-ADM1166TQEBZ](#) [EVAL-ADM1168LQEBZ](#) [EVAL-ADM1171EBZ](#) [EVAL-ADM1276EBZ](#) [EVB-EN5319QI](#) [EVB-EN5365QI](#) [EVB-EN6347QI](#) [EVB-EP5348UI](#) [MIC23158YML EV](#) [MIC23451-AAAYFL EV](#) [MIC5281YMME EV](#) [124352-HMC860LP3E](#) [ADM00513](#) [ADM8611-EVALZ](#) [ADM8612-EVALZ](#) [ADM8613-EVALZ](#) [ADP1046ADC1-EVALZ](#) [ADP1055-EVALZ](#) [ADP122-3.3-EVALZ](#) [ADP130-0.8-EVALZ](#) [ADP130-1.2-EVALZ](#) [ADP130-1.5-EVALZ](#) [ADP130-1.8-EVALZ](#) [ADP160UJZ-REDYKIT](#) [ADP166UJ-EVALZ](#) [ADP1712-3.3-EVALZ](#) [ADP1714-3.3-EVALZ](#) [ADP1715-3.3-EVALZ](#) [ADP1716-2.5-EVALZ](#) [ADP1740-1.5-EVALZ](#) [ADP1752-1.5-EVALZ](#) [ADP1754-1.5-EVALZ](#) [ADP1828LC-EVALZ](#) [ADP1870-0.3-EVALZ](#) [ADP1871-0.6-EVALZ](#) [ADP1873-0.6-EVALZ](#) [ADP1874-0.3-EVALZ](#) [ADP1876-EVALZ](#) [ADP1879-1.0-EVALZ](#) [ADP1882-1.0-EVALZ](#) [ADP1883-0.6-EVALZ](#) [ADP197CB-EVALZ](#) [ADP199CB-EVALZ](#) [ADP2102-1.25-EVALZ](#) [ADP2102-1.2-EVALZ](#) [ADP2102-1.875EVALZ](#)