

## LED Display Driver

### Features

- Continuous Brightness Control
- Serial Data Input
- No Load Signal Requirement
- Enable (MM5450 Only)
- Wide Power Supply Operation
- TTL Compatibility
- 34 or 35 Outputs, 15 mA Capability
- Alphanumeric Capability

### Applications

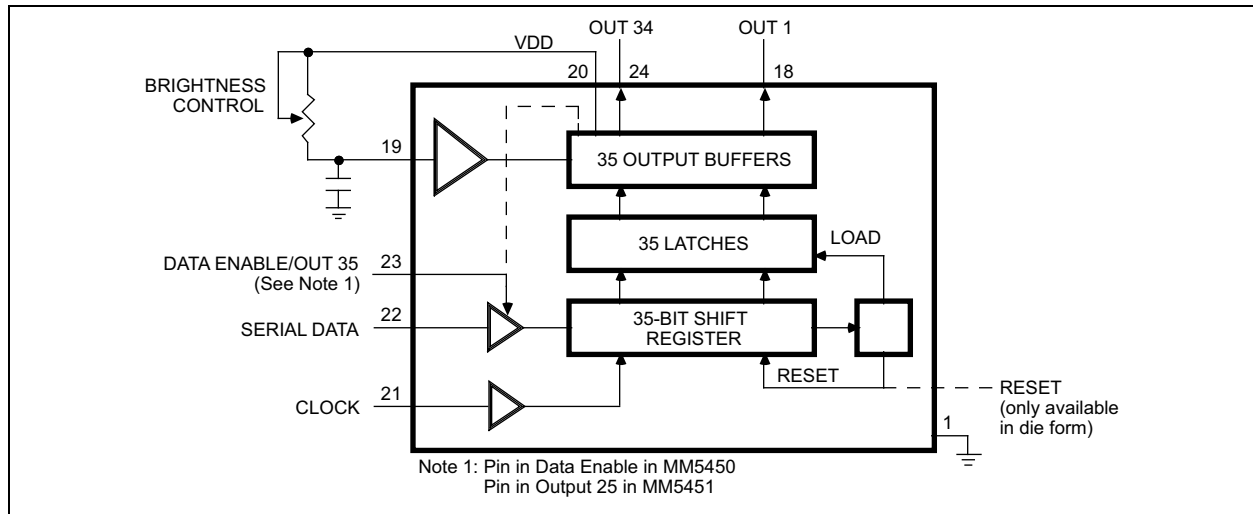
- Industrial Control Indicator
- Relay Driver
- Digital Clock, Thermometer, Counter, Voltmeter
- Instrumentation Readouts

### General Description

The MM5450 and MM5451 LED display drivers are monolithic MOS IC's fabricated in an N-Channel, metal-gate process. The technology produces low-threshold, enhancement-mode, and ion-implanted depletion-mode devices.

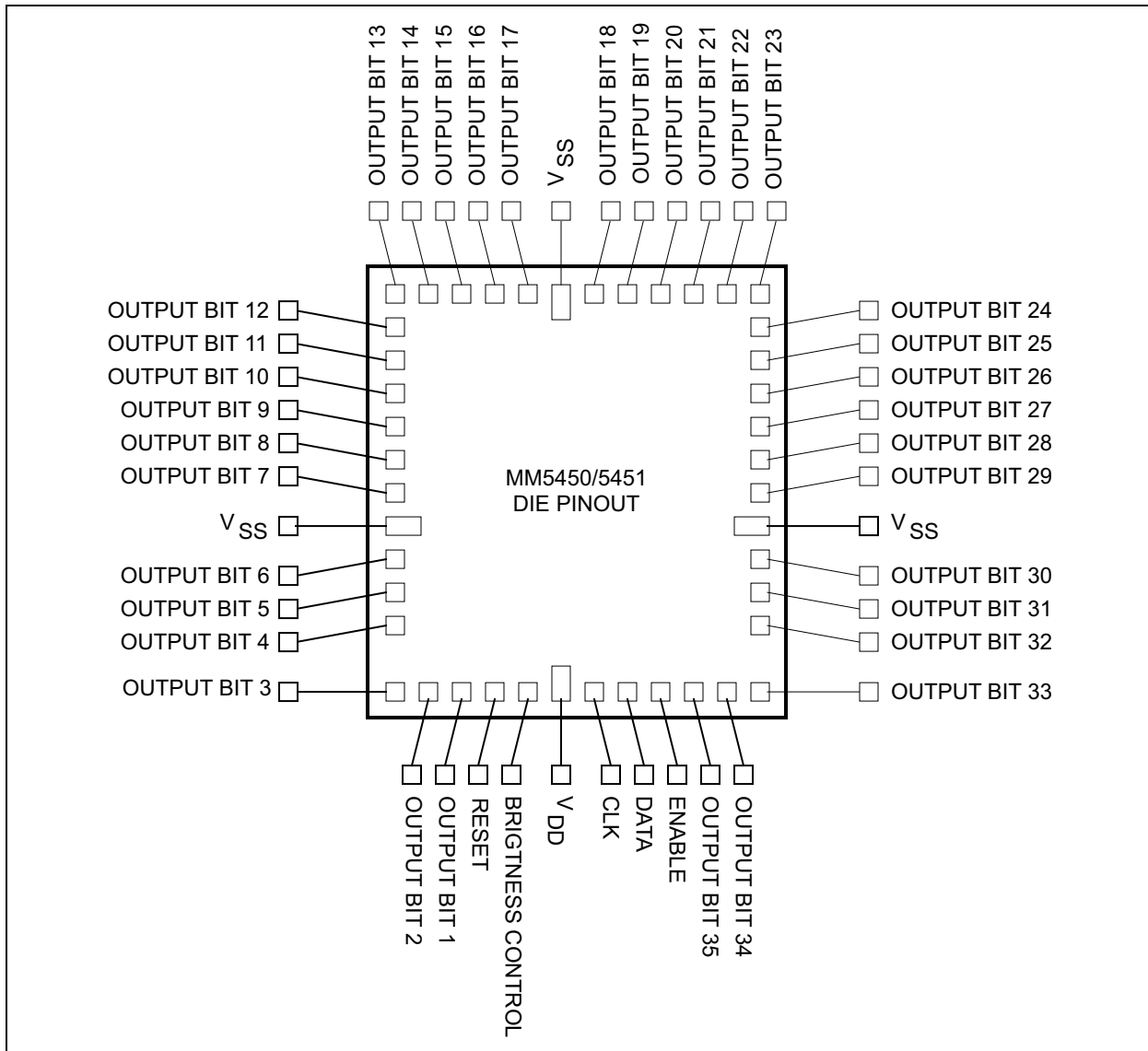
A single pin controls the LED display brightness by setting a reference current through a variable resistor connected to the supply.

### Block Diagram

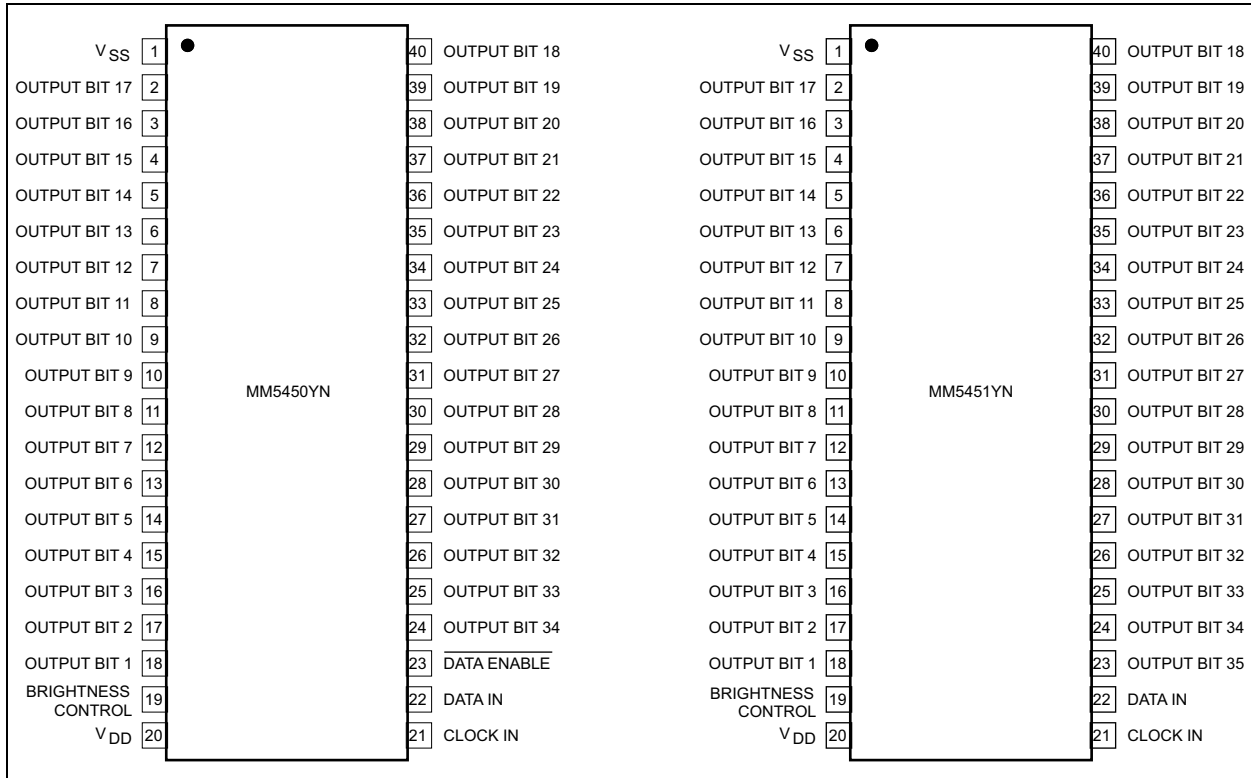


# MM5450/51

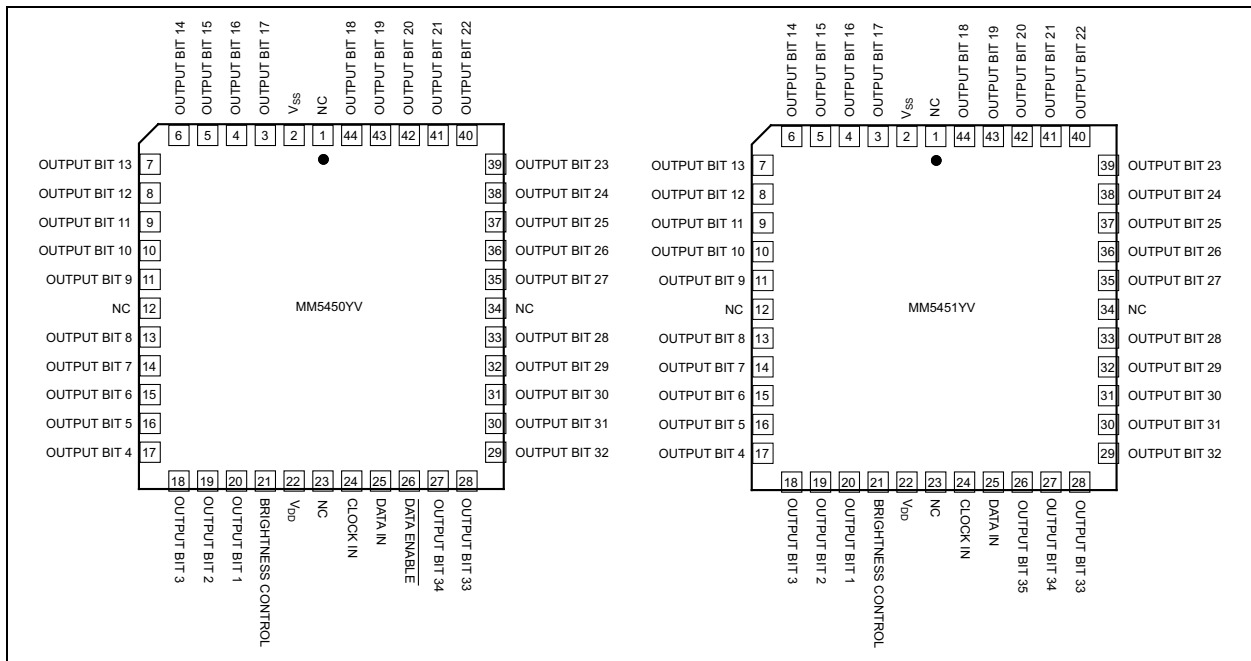
## Connection Diagram: Die



## Connection Diagram: Dual-Inline Package (DIP)



## Connection Diagram: Plastic-Leaded Chip Carrier (PLCC)



# MM5450/51

---

## 1.0 ELECTRICAL CHARACTERISTICS

### Absolute Maximum Ratings †

|                                |                            |
|--------------------------------|----------------------------|
| Voltage (Any Pin).....         | $V_{SS}$ to $V_{SS} + 12V$ |
| Power Dissipation (+25°C)..... | 1W                         |
| Power Dissipation (+85°C)..... | 560 mW                     |

### Operating Ratings ‡

|   |                |
|---|----------------|
| Supply Voltage ( $V_{DD} - V_{SS}$ )..... | +4.75V to +11V |
|---|----------------|

† **Notice:** Stresses above those listed under “Absolute Maximum Ratings” may cause permanent damage to the device. This is a stress rating only and functional operation of the device at those or any other conditions above those indicated in the operational sections of this specification is not intended. Exposure to maximum rating conditions for extended periods may affect device reliability.

‡ **Notice:** The device is not guaranteed to function outside its operating ratings.

**TABLE 1-1: ELECTRICAL CHARACTERISTICS**

**Electrical Characteristics:**  $4.5V \leq V_{DD} \leq 11V$ ,  $V_{SS} = 0V$ ;  $T_A = 25^\circ C$ , **bold** values valid for  $-40^\circ C \leq T_A \leq +85^\circ C$ , unless otherwise noted.

| Parameter                        | Symbol    | Min.                   | Typ. | Max.                       | Units   | Conditions  |
|----------------------------------|-----------|------------------------|------|----------------------------|---------|---|
| Power Supply Current             | —         | —                      | —    | <b>8.5</b>                 | mA      | -25°C to +85°C, excluding output loads  |
|                                  |           | —                      | —    | <b>10</b>                  |         | -40°C to +85°C, excluding output loads  |
| Data Input Voltage               | $V_L$     | <b>-0.3</b>            | —    | <b>0.8</b>                 | V       | Logic-0 level, $\pm 10 \mu A$ input bias  |
|                                  | $V_H$     | <b>2.2</b>             | —    | $V_{DD}$                   |         | Logic-1 level, $4.75V \leq V_{DD} \leq 5.25V$   |
|                                  | —         | $\frac{V_{DD} - 2}{2}$ | —    | $V_{DD}$                   |         | $V_{DD} > 5.25V$  |
| Brightness Control Input Current | —         | <b>0</b>               | —    | <b>0.75</b>                | mA      | <a href="#">Note 1</a>  |
| Output Sink Current              | —         | —                      | —    | <b>10</b>                  | $\mu A$ | Segment off, $V_{OUT} = 3.0V$   |
|                                  |           | <b>0</b>               | —    | <b>10</b>                  |         | Segment on, $V_{OUT} = 1.8V$ , <a href="#">Note 2</a> ;<br>Brightness input = $0 \mu A$   |
|                                  |           | <b>2.0</b>             | 2.7  | <b>4</b>                   | mA      | Segment on, $V_{OUT} = 1.8V$ , <a href="#">Note 2</a> ;<br>Brightness input = $100 \mu A$ |
|                                  |           | <b>15</b>              | —    | <b>25</b>                  |         | Segment on, $V_{OUT} = 1.8V$ , <a href="#">Note 2</a> ;<br>Brightness input = $750 \mu A$ |
| Brightness Control Input Voltage | —         | <b>3.0</b>             | —    | <b>4.3</b>                 | V       | Input current = $750 \mu A$   |
| Output Matching                  | —         | —                      | —    | <b><math>\pm 20</math></b> | %       | <a href="#">Note 3</a> , <a href="#">Note 4</a>   |
| Clock Input Frequency            | $f_C$     | —                      | —    | <b>500</b>                 | kHz     | <a href="#">Note 5</a> , <a href="#">Note 6</a>   |
| Clock Input High Time            | $t_H$     | <b>950</b>             | —    | —                          | ns      | <a href="#">Note 5</a> , <a href="#">Note 6</a>   |
| Clock Input Low Time             | $t_L$     | <b>950</b>             | —    | —                          | ns      | <a href="#">Note 5</a> , <a href="#">Note 6</a>   |
| Data Input Setup Time            | $t_{DS}$  | <b>300</b>             | —    | —                          | ns      | —   |
| Data Input Hold Setup Time       | $t_{DH}$  | <b>300</b>             | —    | —                          | ns      | —   |
| Data Enable Input Setup Time     | $t_{DES}$ | <b>100</b>             | —    | —                          | ns      | —   |
| Reset Pad Current                | —         | <b>-8</b>              | —    | <b>8</b>                   | $\mu A$ | Die.  |

- Note 1:** With a fixed resistor on the brightness input pin, some variation in brightness will occur among devices.
- 2:** See [Figure 2-1](#), [Figure 2-2](#), and [Figure 2-3](#) for recommended operating conditions and limits. Absolute maximum for each output should be limited to 40 mA.
- 3:** Output matching is calculated as the percent variation of  $(I_{MAX} + I_{MIN}) / 2$ .
- 4:**  $V_{OUT}$  should be regulated by user. See [Figure 2-2](#) and [Figure 2-3](#) for allowable  $V_{OUT}$  vs.  $I_{OUT}$  operation.
- 5:** AC input waveform specification for test purpose:  $t_R \leq 200$  ns,  $t_F \leq 20$  ns,  $f = 500$  kHz, 50%  $\pm 10\%$  duty cycle.
- 6:** Clock input rise and fall times must not exceed 300 ns.

# MM5450/51

---

---

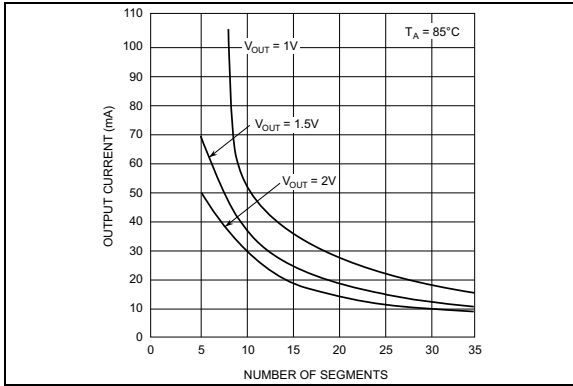
## TEMPERATURE SPECIFICATIONS (Note 1)

| Parameters                | Sym.  | Min. | Typ. | Max. | Units | Conditions |
|---------------------------|-------|------|------|------|-------|------------|
| <b>Temperature Ranges</b> |       |      |      |      |       |            |
| Ambient Temperature Range | $T_A$ | -40  | —    | +85  | °C    | —          |
| Storage Temperature Range | $T_S$ | -65  | —    | +150 | °C    | —          |
| Junction Temperature      | $T_J$ | —    | —    | +150 | °C    | —          |
| Lead Temperature          | —     | —    | —    | +300 | °C    | —          |

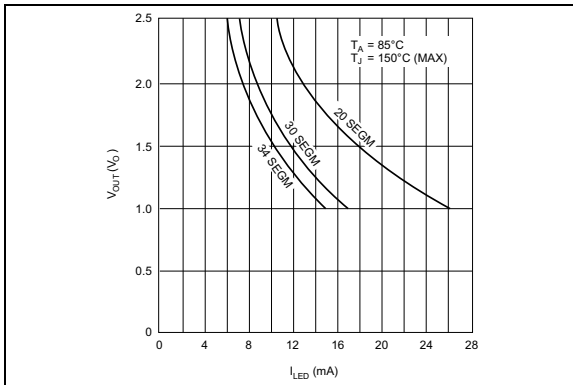
**Note 1:** The maximum allowable power dissipation is a function of ambient temperature, the maximum allowable junction temperature and the thermal resistance from junction to air (i.e.,  $T_A$ ,  $T_J$ ,  $\theta_{JA}$ ). Exceeding the maximum allowable power dissipation will cause the device operating junction temperature to exceed the maximum +125°C rating. Sustained junction temperatures above +125°C can impact the device reliability.

## 2.0 TYPICAL PERFORMANCE CURVES

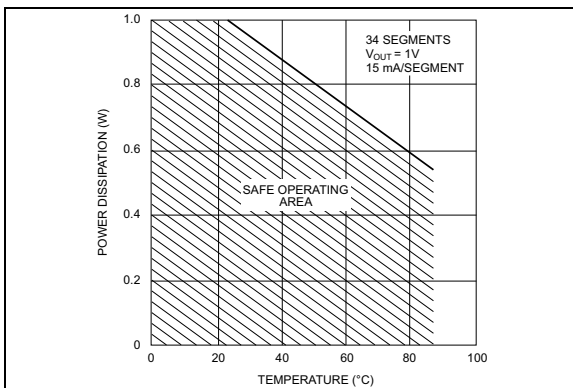
**Note:** The graphs and tables provided following this note are a statistical summary based on a limited number of samples and are provided for informational purposes only. The performance characteristics listed herein are not tested or guaranteed. In some graphs or tables, the data presented may be outside the specified operating range (e.g., outside specified power supply range) and therefore outside the warranted range.



**FIGURE 2-1:** Output Current vs. Number of Segments.



**FIGURE 2-2:** Output Voltage vs. LED Current.



**FIGURE 2-3:** Power Dissipation vs. Temperature.

# MM5450/51

## 3.0 FUNCTIONAL DESCRIPTION

The MM5450 and MM5451 are designed to drive either 4- or 5-digit alphanumeric LED displays with the added benefit of requiring minimal interface with the display or data source.

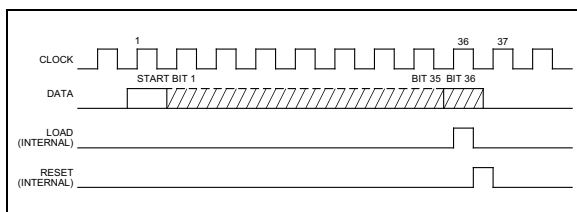
Data is transferred serially via two signals: clock and serial data. Data transfer without the added inconvenience of an external load signal is accomplished by using a format of a leading “1” followed by the allowed 35 data bits. These 35 data bits are latched after the 36th has been transferred. This scheme provides non-multiplexed, direct drive to the LED display. Characters currently displayed (thus, data output) changes only if the serial data bits differ from those previously transferred.

Control of the output current for LED displays provides for the display brightness. To prevent oscillations, a 1 nF capacitor should be connected to pin 19, brightness control.

The [Block Diagram](#) is shown on page 1. For the MIC5450, the /DATA ENABLE is a metal option and is used instead of the 35th output. The output current is typically 20-times greater than the current into pin 19, which is set by an external variable resistor.

There is an external reset connection shown which is available on unpackaged (die) only. [Connection Diagram: Die](#) illustrates the die pad locations for bonding in “chip on board” applications.

[Figure 3-1](#) shows the input data format. A leading “1” is followed by 35 bits of data. After the 36th had been transferred, a LOAD signal is generated synchronously with the clock high state. This loads the 35 bits of data into the latches. The low side of the clock is used to generate a RESET signal which clears all shift registers for the next set of data. All shift registers are static master-slave, with no clear for the master portion of the first register, allowing continuous operation.



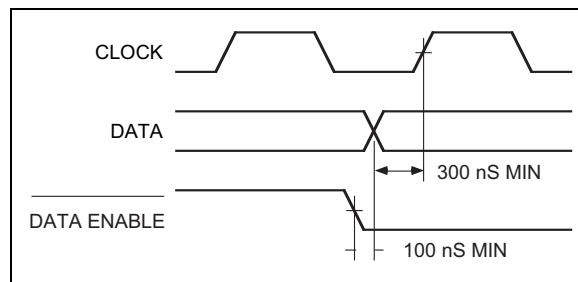
**FIGURE 3-1:** *Input Data Format.*

There must be a complete set of 36 clocks or the shift registers will not clear.

When the chip first powers ON, an internal power ON reset signal is generated that resets all registers and all latches. The START bit and the first clock return the chip to its normal operation.

The [Connection Diagram: Dual-Inline Package \(DIP\)](#) and [Connection Diagram: Plastic-Leaded Chip Carrier \(PLCC\)](#) show the pinout of the MIC5450 and MIC5451. Bit 1 is the first bit following the start bit and it will appear on pin 18. A logical “1” at the input will turn on the appropriate LED.

[Figure 3-2](#) shows the timing relationships between data, clock and /DATA ENABLE. A maximum clock frequency of 0.5 MHz is assumed.



**FIGURE 3-2:** *Timing Diagram.*

For applications where a lesser number of outputs is used, it is possible to either increase the current per output, or operate the part at higher than 1V  $V_{OUT}$ . The following equation can be used for calculations.

### EQUATION 3-1:

$$T_J = V_{OUT} \times I_{LED} \times No \text{ of segments} \times 124^{\circ}C/W + T_A$$

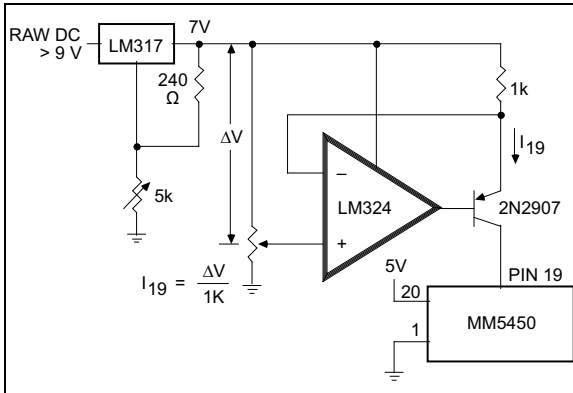
Where:

- $T_J$  Junction Temperature (+150°C max.)
- $V_{OUT}$  Voltage at the LED driver outputs
- $I_{LED}$  LED current
- $124^{\circ}C/W$  Thermal resistance of the package
- $T_A$  Ambient temperature

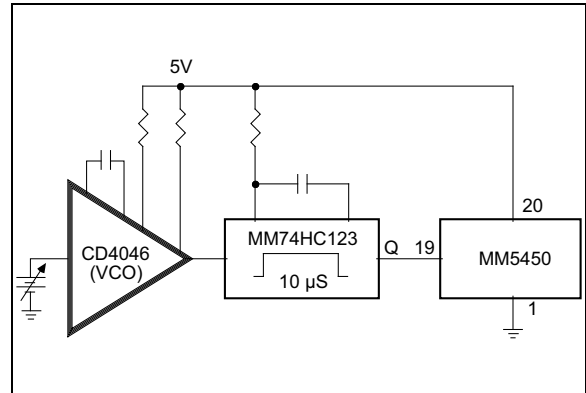
[Equation 3-1](#) is used to plot [Figure 2-1](#), [Figure 2-2](#), and [Figure 2-3](#).



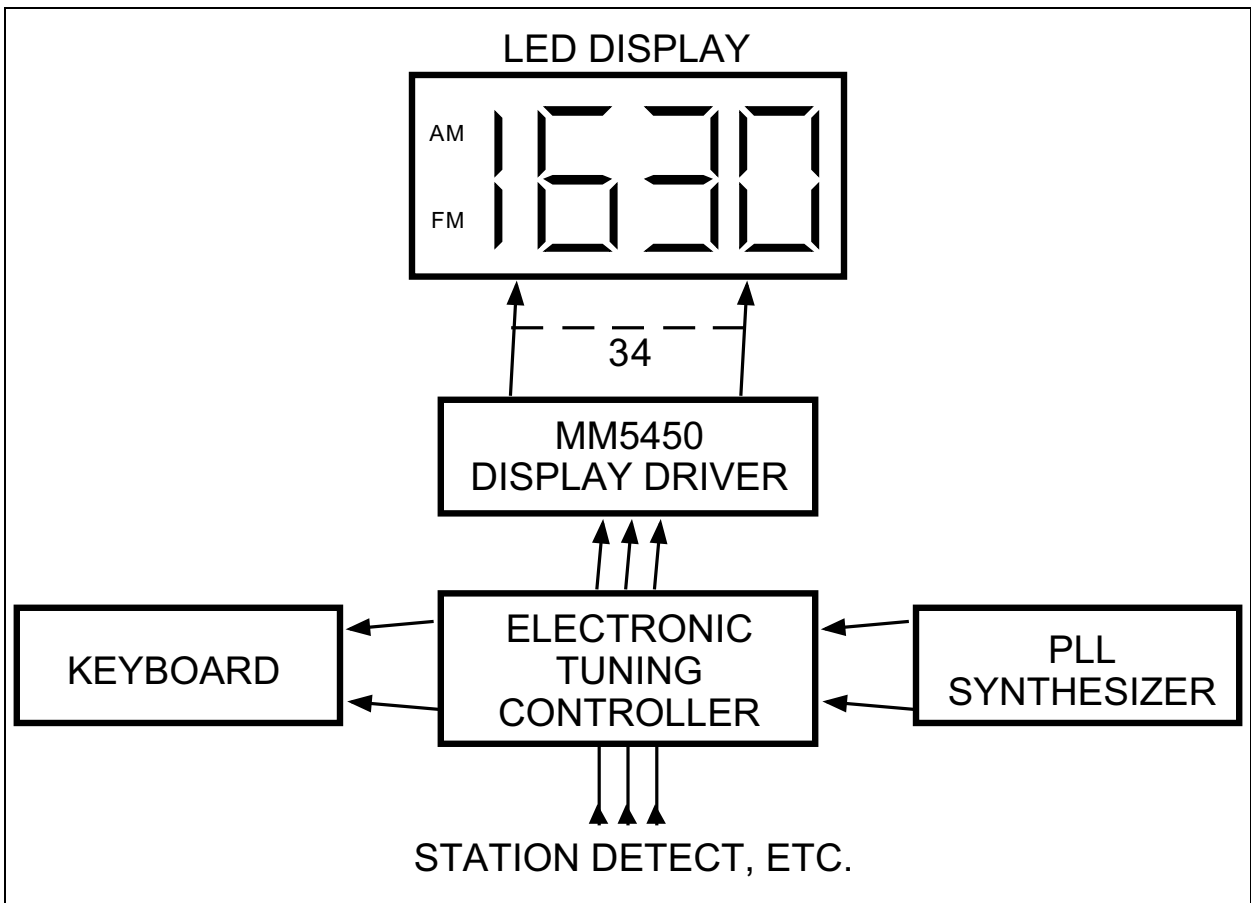
## 4.0 TYPICAL APPLICATIONS



**FIGURE 4-1:** Typical Application of Constant Current Brightness Control.

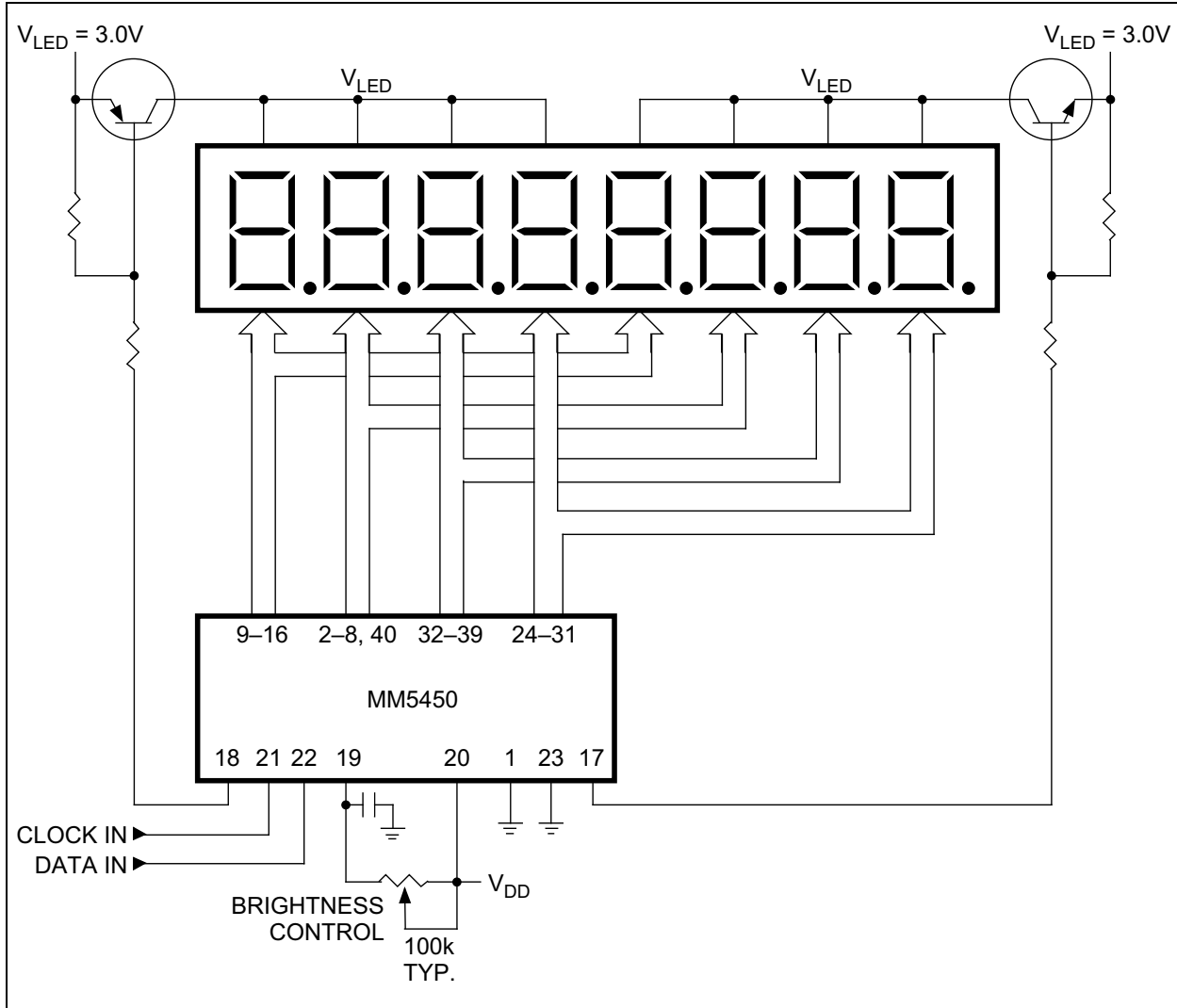


**FIGURE 4-2:** Brightness Control Varying the Duty Cycle.



**FIGURE 4-3:** Basic Electronically Tuned Radio System.

# MM5450/51

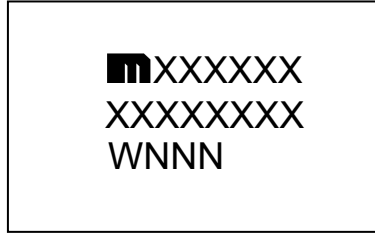


**FIGURE 4-4:** Duplexing Eight Digits with One MM5450.

## 5.0 PACKAGING INFORMATION

### 5.1 Package Marking Information

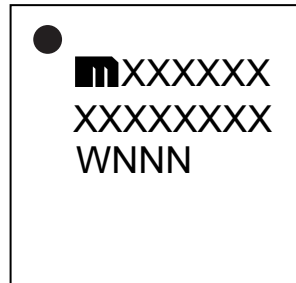
40-Pin PDIP\*



Example



44-Pin PLCC\*



Example



|                |         |  |
|----------------|---------|--|
| <b>Legend:</b> | XX...X  | Product code or customer-specific information  |
|                | Y       | Year code (last digit of calendar year)  |
|                | YY      | Year code (last 2 digits of calendar year)   |
|                | WW      | Week code (week of January 1 is week '01')   |
|                | NNN     | Alphanumeric traceability code   |
|                | (e3)    | Pb-free JEDEC® designator for Matte Tin (Sn)   |
|                | *       | This package is Pb-free. The Pb-free JEDEC designator ((e3)) can be found on the outer packaging for this package. |
|                | •, ▲, ▼ | Pin one index is identified by a dot, delta up, or delta down (triangle mark).                                     |

**Note:** In the event the full Microchip part number cannot be marked on one line, it will be carried over to the next line, thus limiting the number of available characters for customer-specific information. Package may or may not include the corporate logo.

Underbar ( \_ ) and/or Overbar ( ¯ ) symbol may not be to scale.

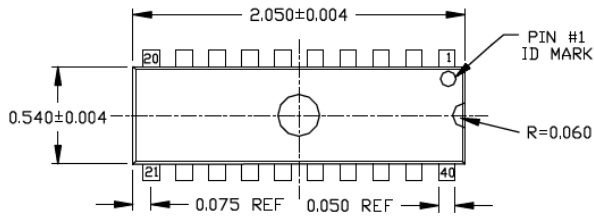
# MM5450/51

## 40-Lead PDIP Package Outline and Recommended Land Pattern

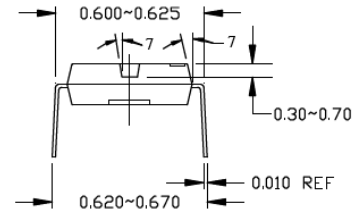
**TITLE**

40 LEAD PDIP PACKAGE OUTLINE & RECOMMENDED LAND PATTERN

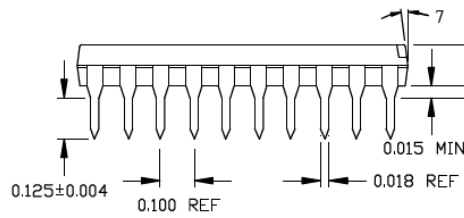
|                   |                |                    |           |
|-------------------|----------------|--------------------|-----------|
| <b>DRAWING #</b>  | PDIP-40LD-PL-1 | <b>UNIT</b>        | INCH      |
| <b>Lead Frame</b> | Copper         | <b>Lead Finish</b> | Matte Tin |



**TOP VIEW**



**END VIEW**



**SIDE VIEW**

1. SPADE WIDTH, LEAD WIDTH AND LEAD THICKNESS EXCLUSIVE OF TIN PLATING OR SOLDER PLATING/ DIPPING THICKNESS.
2. PACKAGE OUTLINE EXCLUSIVE OF ANY MOLD FLASHES.
3. PACKAGE OUTLINE EXCLUSIVE OF BURR DIMENSION.

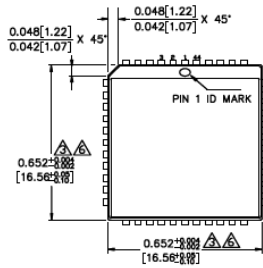
Note: For the most current package drawings, please see the Microchip Packaging Specification located at <http://www.microchip.com/packaging>.

## 44-Lead PLCC Package Outline and Recommended Land Pattern

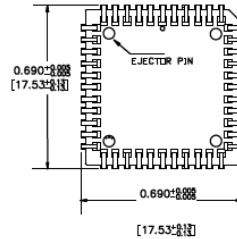
**TITLE**

44 LEAD PLCC PACKAGE OUTLINE & RECOMMENDED LAND PATTERN

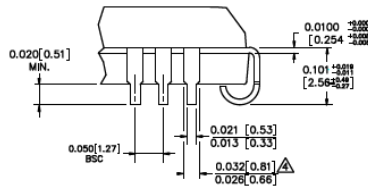
| DRAWING #  | PLCC-44LD-PL-1 | UNIT        | INCH      |
|------------|----------------|-------------|-----------|
| Lead Frame | Copper         | Lead Finish | Matte Tin |



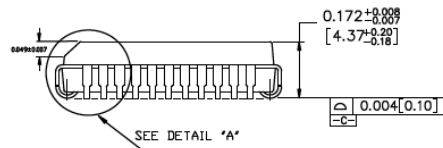
TOP VIEW



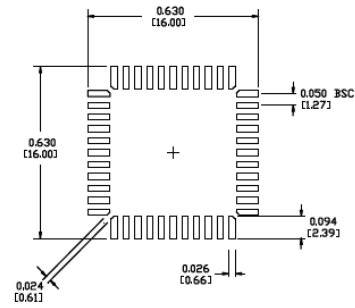
BOTTOM VIEW



DETAIL "A"



SIDE VIEW



RECOMMENDED LAND PATTERN

- NOTES:**
1. DIMENSIONS ARE IN INCHES DIM3.
  2. CONTROLLING DIMENSION INCHES.
  3. DIMENSION DOES NOT INCLUDE WELD FLASH OR PROTRUSIONS, EITHER OF WHICH SHALL NOT EXCEED 0.009 [0.231].
  4. LEAD DIMENSION DOES NOT INCLUDE DAMBAR PROTRUSION.
  5. MAXIMUM AND MINIMUM SPECIFICATIONS ARE INDICATED AS FOLLOWS: MAX/MIN.
  6. PACKAGE TOP DIMENSION MAY BE SLIGHTLY SMALLER THAN BOTTOM DIMENSION.
  7. EJECTOR PIN COUNT WILL EITHER BE TWO OR FOUR PINS.

Note: For the most current package drawings, please see the Microchip Packaging Specification located at <http://www.microchip.com/packaging>.

# MM5450/51

---

NOTES:

## APPENDIX A: REVISION HISTORY

### Revision A (October 2016)

- Converted Micrel document MM5450/51 to Microchip data sheet DS20005651A.
- Minor text changes throughout.
- Corrected Pin 26 of the MM5451YV in [Connection Diagram: Plastic-Leaded Chip Carrier \(PLCC\)](#) to read Output Bit 35.
- Corrected the minimum value for Reset Pad Current in [Table 1-1](#) to be  $-8\ \mu\text{A}$ .

# MM5450/51

---

NOTES:



## PRODUCT IDENTIFICATION SYSTEM

To order or obtain information, e.g., on pricing or delivery, contact your local Microchip representative or sales office.

| <u>PART NO.</u>                    |  | X       | XX         | - | XX |
|------------------------------------|--|---------|------------|---|----|
| Device                             | Junction Temperature Range   | Package | Media Type |   |    |
| <b>Device:</b>                     | MM5450: LED Display Driver (with Enable)<br>MM5451: LED Display Driver                           |         |            |   |    |
| <b>Junction Temperature Range:</b> | Y = -40°C to +85°C   |         |            |   |    |
| <b>Package:</b>                    | N = 40-Lead PDIP<br>V = 44-Lead PLCC   |         |            |   |    |
| <b>Media Type:</b>                 | TR = 500/Reel for V Package<br>(blank) = 9/Tube for N Package<br>(blank) = 26/Tube for V Package |         |            |   |    |

| <b>Examples:</b> |   |
|------------------|---|
| a) MM5450YN:     | LED Display Driver with Enable<br>-40°C to +85°C Junction Temperature Range, 40-Lead PDIP, 9/Tube   |
| b) MM5450YV:     | LED Display Driver with Enable<br>-40°C to +85°C Junction Temperature Range, 44-Lead PLCC, 26/Tube  |
| c) MM5450YV-TR:  | LED Display Driver with Enable<br>-40°C to +85°C Junction Temperature Range, 44-Lead PLCC, 500/Reel |
| a) MM5451YN:     | LED Display Driver<br>-40°C to +85°C Junction Temperature Range, 40-Lead PDIP, 9/Tube               |
| b) MM5451YV:     | LED Display Driver<br>-40°C to +85°C Junction Temperature Range, 44-Lead PLCC, 26/Tube              |
| c) MM5451YV-TR:  | LED Display Driver<br>-40°C to +85°C Junction Temperature Range, 44-Lead PLCC, 500/Reel             |

**Note 1:** Tape and Reel identifier only appears in the catalog part number description. This identifier is used for ordering purposes and is not printed on the device package. Check with your Microchip Sales Office for package availability with the Tape and Reel option.

# MM5450/51

---

NOTES:

---

**Note the following details of the code protection feature on Microchip devices:**

- Microchip products meet the specification contained in their particular Microchip Data Sheet.
- Microchip believes that its family of products is one of the most secure families of its kind on the market today, when used in the intended manner and under normal conditions.
- There are dishonest and possibly illegal methods used to breach the code protection feature. All of these methods, to our knowledge, require using the Microchip products in a manner outside the operating specifications contained in Microchip's Data Sheets. Most likely, the person doing so is engaged in theft of intellectual property.
- Microchip is willing to work with the customer who is concerned about the integrity of their code.
- Neither Microchip nor any other semiconductor manufacturer can guarantee the security of their code. Code protection does not mean that we are guaranteeing the product as “unbreakable.”

Code protection is constantly evolving. We at Microchip are committed to continuously improving the code protection features of our products. Attempts to break Microchip's code protection feature may be a violation of the Digital Millennium Copyright Act. If such acts allow unauthorized access to your software or other copyrighted work, you may have a right to sue for relief under that Act.

---

Information contained in this publication regarding device applications and the like is provided only for your convenience and may be superseded by updates. It is your responsibility to ensure that your application meets with your specifications. MICROCHIP MAKES NO REPRESENTATIONS OR WARRANTIES OF ANY KIND WHETHER EXPRESS OR IMPLIED, WRITTEN OR ORAL, STATUTORY OR OTHERWISE, RELATED TO THE INFORMATION, INCLUDING BUT NOT LIMITED TO ITS CONDITION, QUALITY, PERFORMANCE, MERCHANTABILITY OR FITNESS FOR PURPOSE. Microchip disclaims all liability arising from this information and its use. Use of Microchip devices in life support and/or safety applications is entirely at the buyer's risk, and the buyer agrees to defend, indemnify and hold harmless Microchip from any and all damages, claims, suits, or expenses resulting from such use. No licenses are conveyed, implicitly or otherwise, under any Microchip intellectual property rights unless otherwise stated.

*Microchip received ISO/TS-16949:2009 certification for its worldwide headquarters, design and wafer fabrication facilities in Chandler and Tempe, Arizona; Gresham, Oregon and design centers in California and India. The Company's quality system processes and procedures are for its PIC® MCUs and dsPIC® DSCs, KEELoc® code hopping devices, Serial EEPROMs, microperipherals, nonvolatile memory and analog products. In addition, Microchip's quality system for the design and manufacture of development systems is ISO 9001:2000 certified.*

**QUALITY MANAGEMENT SYSTEM  
CERTIFIED BY DNV  
= ISO/TS 16949 =**

### Trademarks

The Microchip name and logo, the Microchip logo, AnyRate, dsPIC, FlashFlex, flexPWR, Heldo, JukeBlox, KeeLoq, KeeLoq logo, Klear, LANCheck, LINK MD, MediaLB, MOST, MOST logo, MPLAB, OptoLyzer, PIC, PICSTART, PIC32 logo, RightTouch, SpyNIC, SST, SST Logo, SuperFlash and UNI/O are registered trademarks of Microchip Technology Incorporated in the U.S.A. and other countries.

ClockWorks, The Embedded Control Solutions Company, ETHERSYNCH, Hyper Speed Control, HyperLight Load, IntelliMOS, mTouch, Precision Edge, and QUIET-WIRE are registered trademarks of Microchip Technology Incorporated in the U.S.A.

Analog-for-the-Digital Age, Any Capacitor, AnyIn, AnyOut, BodyCom, chipKIT, chipKIT logo, CodeGuard, dsPICDEM, dsPICDEM.net, Dynamic Average Matching, DAM, ECAN, EtherGREEN, In-Circuit Serial Programming, ICSP, Inter-Chip Connectivity, JitterBlocker, KlearNet, KlearNet logo, MiWi, motorBench, MPASM, MPF, MPLAB Certified logo, MPLIB, MPLINK, MultiTRAK, NetDetach, Omniscient Code Generation, PICDEM, PICDEM.net, PICkit, PICtail, PureSilicon, RightTouch logo, REAL ICE, Ripple Blocker, Serial Quad I/O, SQL, SuperSwitcher, SuperSwitcher II, Total Endurance, TSHARC, USBCheck, VariSense, ViewSpan, WiperLock, Wireless DNA, and ZENA are trademarks of Microchip Technology Incorporated in the U.S.A. and other countries.

SQTP is a service mark of Microchip Technology Incorporated in the U.S.A.

Silicon Storage Technology is a registered trademark of Microchip Technology Inc. in other countries.

GestIC is a registered trademarks of Microchip Technology Germany II GmbH & Co. KG, a subsidiary of Microchip Technology Inc., in other countries.

All other trademarks mentioned herein are property of their respective companies.

© 2016, Microchip Technology Incorporated, Printed in the U.S.A., All Rights Reserved.

ISBN: 978-1-5224-1052-2



# MICROCHIP

## Worldwide Sales and Service

### AMERICAS

#### Corporate Office

2355 West Chandler Blvd.  
Chandler, AZ 85224-6199

Tel: 480-792-7200

Fax: 480-792-7277

Technical Support:

[http://www.microchip.com/  
support](http://www.microchip.com/support)

Web Address:

[www.microchip.com](http://www.microchip.com)

#### Atlanta

Duluth, GA

Tel: 678-957-9614

Fax: 678-957-1455

#### Austin, TX

Tel: 512-257-3370

#### Boston

Westborough, MA

Tel: 774-760-0087

Fax: 774-760-0088

#### Chicago

Itasca, IL

Tel: 630-285-0071

Fax: 630-285-0075

#### Cleveland

Independence, OH

Tel: 216-447-0464

Fax: 216-447-0643

#### Dallas

Addison, TX

Tel: 972-818-7423

Fax: 972-818-2924

#### Detroit

Novi, MI

Tel: 248-848-4000

#### Houston, TX

Tel: 281-894-5983

#### Indianapolis

Noblesville, IN

Tel: 317-773-8323

Fax: 317-773-5453

#### Los Angeles

Mission Viejo, CA

Tel: 949-462-9523

Fax: 949-462-9608

#### New York, NY

Tel: 631-435-6000

#### San Jose, CA

Tel: 408-735-9110

#### Canada - Toronto

Tel: 905-695-1980

Fax: 905-695-2078

### ASIA/PACIFIC

#### Asia Pacific Office

Suites 3707-14, 37th Floor  
Tower 6, The Gateway  
Harbour City, Kowloon

#### Hong Kong

Tel: 852-2943-5100

Fax: 852-2401-3431

#### Australia - Sydney

Tel: 61-2-9868-6733

Fax: 61-2-9868-6755

#### China - Beijing

Tel: 86-10-8569-7000

Fax: 86-10-8528-2104

#### China - Chengdu

Tel: 86-28-8665-5511

Fax: 86-28-8665-7889

#### China - Chongqing

Tel: 86-23-8980-9588

Fax: 86-23-8980-9500

#### China - Dongguan

Tel: 86-769-8702-9880

#### China - Guangzhou

Tel: 86-20-8755-8029

#### China - Hangzhou

Tel: 86-571-8792-8115

Fax: 86-571-8792-8116

#### China - Hong Kong SAR

Tel: 852-2943-5100

Fax: 852-2401-3431

#### China - Nanjing

Tel: 86-25-8473-2460

Fax: 86-25-8473-2470

#### China - Qingdao

Tel: 86-532-8502-7355

Fax: 86-532-8502-7205

#### China - Shanghai

Tel: 86-21-5407-5533

Fax: 86-21-5407-5066

#### China - Shenyang

Tel: 86-24-2334-2829

Fax: 86-24-2334-2393

#### China - Shenzhen

Tel: 86-755-8864-2200

Fax: 86-755-8203-1760

#### China - Wuhan

Tel: 86-27-5980-5300

Fax: 86-27-5980-5118

#### China - Xian

Tel: 86-29-8833-7252

Fax: 86-29-8833-7256

### ASIA/PACIFIC

#### China - Xiamen

Tel: 86-592-2388138

Fax: 86-592-2388130

#### China - Zhuhai

Tel: 86-756-3210040

Fax: 86-756-3210049

#### India - Bangalore

Tel: 91-80-3090-4444

Fax: 91-80-3090-4123

#### India - New Delhi

Tel: 91-11-4160-8631

Fax: 91-11-4160-8632

#### India - Pune

Tel: 91-20-3019-1500

#### Japan - Osaka

Tel: 81-6-6152-7160

Fax: 81-6-6152-9310

#### Japan - Tokyo

Tel: 81-3-6880-3770

Fax: 81-3-6880-3771

#### Korea - Daegu

Tel: 82-53-744-4301

Fax: 82-53-744-4302

#### Korea - Seoul

Tel: 82-2-554-7200

Fax: 82-2-558-5932 or

82-2-558-5934

#### Malaysia - Kuala Lumpur

Tel: 60-3-6201-9857

Fax: 60-3-6201-9859

#### Malaysia - Penang

Tel: 60-4-227-8870

Fax: 60-4-227-4068

#### Philippines - Manila

Tel: 63-2-634-9065

Fax: 63-2-634-9069

#### Singapore

Tel: 65-6334-8870

Fax: 65-6334-8850

#### Taiwan - Hsin Chu

Tel: 886-3-5778-366

Fax: 886-3-5770-955

#### Taiwan - Kaohsiung

Tel: 886-7-213-7828

#### Taiwan - Taipei

Tel: 886-2-2508-8600

Fax: 886-2-2508-0102

#### Thailand - Bangkok

Tel: 66-2-694-1351

Fax: 66-2-694-1350

### EUROPE

#### Austria - Wels

Tel: 43-7242-2244-39

Fax: 43-7242-2244-393

#### Denmark - Copenhagen

Tel: 45-4450-2828

Fax: 45-4485-2829

#### France - Paris

Tel: 33-1-69-53-63-20

Fax: 33-1-69-30-90-79

#### Germany - Dusseldorf

Tel: 49-2129-3766400

#### Germany - Karlsruhe

Tel: 49-721-625370

#### Germany - Munich

Tel: 49-89-627-144-0

Fax: 49-89-627-144-44

#### Italy - Milan

Tel: 39-0331-742611

Fax: 39-0331-466781

#### Italy - Venice

Tel: 39-049-7625286

#### Netherlands - Drunen

Tel: 31-416-690399

Fax: 31-416-690340

#### Poland - Warsaw

Tel: 48-22-3325737

#### Spain - Madrid

Tel: 34-91-708-08-90

Fax: 34-91-708-08-91

#### Sweden - Stockholm

Tel: 46-8-5090-4654

#### UK - Wokingham

Tel: 44-118-921-5800

Fax: 44-118-921-5820

06/23/16

## X-ON Electronics

Largest Supplier of Electrical and Electronic Components

*Click to view similar products for [LED Display Drivers](#) category:*

*Click to view products by [Microchip](#) manufacturer:*

Other Similar products are found below :

[MAP9000QNRH](#) [AS3693B-ZTQT](#) [SCT2027CSSG](#) [ME2206AM6G](#) [WS3130S8P](#) [WS3132S7P](#) [WS3136D7P](#) [WS3256D8P](#) [WS3418AD7P](#)  
[WS9012S8P](#) [WS9620BDP](#) [FM6126QC](#) [TC7559C](#) [FM6565QB](#) [LYT3315D](#) [SCT2001ASIG](#) [SCT2024CSOG](#) [SCT2024CSSG](#) [SCT2024CSTG](#)  
[SCT2167CSSG](#) [AL8400QSE-7](#) [PR4401](#) [PR4403](#) [WS2821B](#) [PR4402](#) [RT8471GJ5](#) [RT9284A-20GJ6E](#) [LP5562TMX](#) [TC7117ACLW](#)  
[DLD101Q-7](#) [WS2818B](#) [BCR401U](#) [BCR402U](#) [SCT2004CSOG](#) [SCT2026CSOG](#) [SCT2026CSSG](#) [SCT2026CSTG](#) [SCT2110CSSG](#) [SCT2932J](#)  
[LM3429MH](#) [PR4101A](#) [PR4404](#) [AS1130-BSST](#) [CP2155DN10-A1](#) [BCT3220ELA-TR](#) [AW2013DNR](#) [AW3641EDNR](#) [WD3153D-10/TR](#)  
[AW36404DNR](#) [AL8400SE-7](#)