

**MSCSM120AM03CT6LIAG**

**Datasheet**

**Very Low Stray Inductance Phase Leg SiC  
MOSFET Power Module**

January 2020



---

a  **MICROCHIP** company

# Contents

---

Revision History.....	1
1.1 Revision 1.0.....	1
Product Overview.....	2
2.1 Features.....	3
2.2 Benefits.....	3
2.3 Applications.....	3
Electrical Specifications.....	4
3.1 SiC MOSFET Characteristics (Per MOSFET).....	4
3.2 SiC Diode Characteristics (Per SiC Diode).....	6
3.3 Thermal and Package Characteristics.....	7
3.4 SiC MOSFET Performance Curves.....	8
3.5 SiC Diode Performance Curves.....	11
Package Outline.....	12
4.1 Package Outline Drawing.....	12

# 1 Revision History

---

The revision history describes the changes that were implemented in the document. The changes are listed by revision, starting with the most current publication.

## 1.1 Revision 1.0

Revision 1.0 was published in January 2020. It is the first publication of this document.

## 2 Product Overview

The MSCSM120AM03CT6LIAG device is a 1200 V, 805 A full Silicon Carbide power module.

**Figure 1 • Electrical Schematic of MSCSM120AM03CT6LIAG Device**

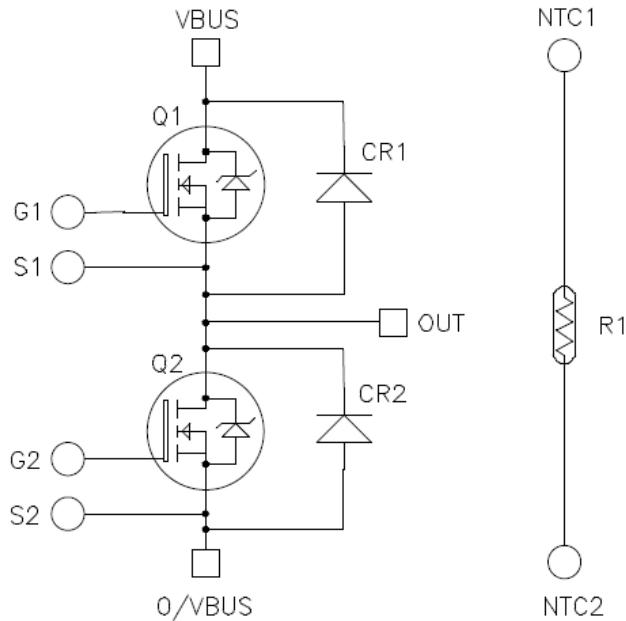

**Figure 2 • Pinout Location**

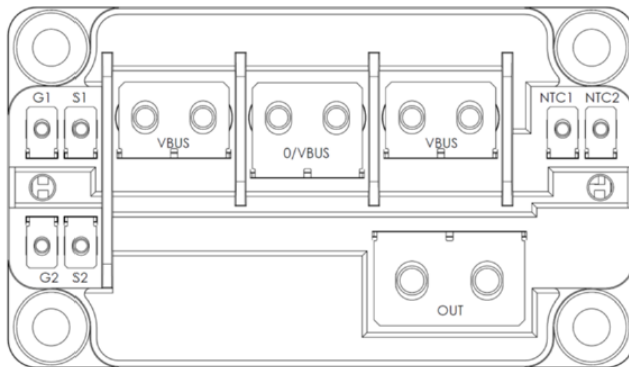

All ratings at  $T_j = 25\text{ }^\circ\text{C}$ , unless otherwise specified.

**Caution:** These devices are sensitive to electrostatic discharge. Proper handling procedures should be followed.

## 2.1 Features

The following are the features of MSCSM120AM03CT6LIAG device:

- SiC power MOSFET
  - Low  $R_{DS(on)}$
  - High temperature performance
- SiC Schottky diode
  - Zero reverse recovery
  - Zero forward recovery
  - Temperature independent switching behavior
  - Positive temperature coefficient on VF
- Very low stray inductance
- Internal thermistor for temperature monitoring
- M4 and M5 power connectors
- M2.5 signals connectors
- AlN substrate for improved thermal performance

## 2.2 Benefits

The following are the benefits of MSCSM120AM03CT6LIAG device:

- High efficiency converter
- Outstanding performance at high frequency operation
- Direct mounting to heatsink (isolated package)
- Low junction-to-case thermal resistance
- Low profile
- RoHS compliant

## 2.3 Applications

The following are the applications of MSCSM120AM03CT6LIAG device:

- Welding converters
- Switched mode power supplies
- Uninterruptible power supplies
- EV motor and traction drive

## 3 Electrical Specifications

This section provides the electrical specifications for the MSCSM120AM03CT6LIAG device.

### 3.1 SiC MOSFET Characteristics (Per MOSFET)

The following table shows the absolute maximum ratings of MSCSM120AM03CT6LIAG device.

**Table 1 • Absolute Maximum Ratings**

Symbol	Parameters	Maximum Ratings	Unit	
$V_{DSS}$	Drain–source voltage	1200	V	
$I_D$	Continuous drain current	$T_C = 25^\circ\text{C}$	805 <sup>1</sup>	A
		$T_C = 80^\circ\text{C}$	640 <sup>1</sup>	
$I_{DM}$	Pulsed drain current	1600		
$V_{GS}$	Gate–source voltage	–10/25	V	
$R_{DS(on)}$	Drain–source ON resistance	3.1	m $\Omega$	
$P_D$	Power dissipation	$T_C = 25^\circ\text{C}$	3215	W

**Note:**

1. Specification of SiC MOSFET device but output current must be limited due to size of power connectors.

The following table shows the electrical characteristics of MSCSM120AM03CT6LIAG device.

**Table 2 • Electrical Characteristics**

Symbol	Characteristics	Test Conditions	Min	Typ	Max	Unit
$I_{DSS}$	Zero gate voltage drain current	$V_{GS} = 0\text{ V}$ ; $V_{DS} = 1200\text{ V}$		150	1000	$\mu\text{A}$
$R_{DS(on)}$	Drain–source on resistance	$V_{GS} = 20\text{ V}$ $I_D = 400\text{ A}$	$T_C = 25^\circ\text{C}$	2.5	3.1	m $\Omega$
			$T_C = 175^\circ\text{C}$	4		
$V_{GS(th)}$	Gate threshold voltage	$V_{GS} = V_{DS}$ , $I_D = 10\text{ mA}$	1.8	2.8		V
$I_{GSS}$	Gate–source leakage current	$V_{GS} = 20\text{ V}$ , $V_{DS} = 0\text{ V}$			1	$\mu\text{A}$

The following table shows the dynamic characteristics of MSCSM120AM03CT6LIAG device.

**Table 3 • Dynamic Characteristics**

Symbol	Characteristics	Test Conditions	Min	Typ	Max	Unit
$C_{iss}$	Input capacitance	$V_{GS} = 0\text{ V}$		30.2		nF
$C_{oss}$	Output capacitance	$V_{DS} = 1000\text{ V}$ $f = 1\text{ MHz}$		2.7		
$C_{rss}$	Reverse transfer capacitance			0.25		
$Q_g$	Total gate charge	$V_{GS} = -5/20\text{ V}$ $V_{Bus} = 800\text{ V}$ $I_D = 400\text{ A}$		2320		nC
$Q_{gs}$	Gate–source charge			410		
$Q_{gd}$	Gate–drain charge			500		
$T_{d(on)}$	Turn-on delay time	$V_{GS} = -5/20\text{ V}$ $T_J = 150\text{ }^\circ\text{C}$		56		ns
$T_r$	Rise time	$V_{Bus} = 600\text{ V}$		55		
$T_{d(off)}$	Turn-off delay time	$I_D = 500\text{ A}$ $R_G = 0.3\ \Omega$		166		
$T_f$	Fall time			67		
$E_{on}$	Turn on energy	Inductive switching $T_J = 150\text{ }^\circ\text{C}$		9.2		mJ
$E_{off}$	Turn off energy	$V_{GS} = -5/20\text{ V}$ $V_{Bus} = 600\text{ V}$ $I_D = 500\text{ A}$ $R_G = 0.3\ \Omega$		8.3		
$R_{Gint}$	Internal gate resistance			0.98		$\Omega$
$R_{thJC}$	Junction-to-case thermal resistance				0.047	$^\circ\text{C/W}$

The following table shows the body diode ratings and characteristics of MSCSM120AM03CT6LIAG device.

**Table 4 • Body Diode Ratings and Characteristics**

Symbol	Characteristics	Test Conditions	Min	Typ	Max	Unit
$V_{SD}$	Diode forward voltage	$V_{GS} = 0\text{ V}$ ; $I_{SD} = 400\text{ A}$		4		V
		$V_{GS} = -5\text{ V}$ ; $I_{SD} = 400\text{ A}$		4.2		
$t_{rr}$	Reverse recovery time	$I_{SD} = 400\text{ A}$ ; $V_{GS} = -5\text{ V}$		90		ns
$Q_{rr}$	Reverse recovery charge	$V_R = 800\text{ V}$ ; $di_F/dt = 10000\text{ A}/\mu\text{s}$		5.5		$\mu\text{C}$
$I_{rr}$	Reverse recovery current			135		A

### 3.2 SiC Diode Characteristics (Per SiC Diode)

The following table shows the SiC diode characteristics (per SiC diode) of MSCSM120AM03CT6LIAG device.

**Table 5 • SiC Diode Characteristics (Per SiC Diode)**

Symbol	Characteristics	Test Conditions	Min	Typ	Max	Unit
$V_{RRM}$	Peak repetitive reverse voltage				1200	V
$I_{RM}$	Reverse leakage current	$V_R = 1200\text{ V}$	$T_J = 25\text{ °C}$	0.08	1	mA
			$T_J = 175\text{ °C}$	1.25		
$I_F$	DC forward current		$T_C = 95\text{ °C}$	250		A
$V_F$	Diode forward voltage	$I_F = 250\text{ A}$	$T_J = 25\text{ °C}$	1.5	1.8	V
			$T_J = 175\text{ °C}$	2.1		
$Q_C$	Total capacitive charge	$V_R = 600\text{ V}$		1120		nC
C	Total capacitance	$f = 1\text{ MHz}, V_R = 400\text{ V}$		1230		pF
		$f = 1\text{ MHz}, V_R = 800\text{ V}$		910		
$R_{thJC}$	Junction-to-case thermal resistance				0.126	°C/W



### 3.3 Thermal and Package Characteristics

The following table shows the package characteristics of MSCSM120AM03CT6LIAG device.

**Table 6 • Package Characteristics**

Symbol	Characteristics		Min	Max	Unit	
V <sub>ISOL</sub>	RMS isolation voltage, any terminal to case t =1 min, 50/60 Hz		4000		V	
T <sub>J</sub>	Operating junction temperature range		-40	175	°C	
T <sub>JOP</sub>	Recommended junction temperature under switching conditions		-40	T <sub>Jmax</sub> -25		
T <sub>STG</sub>	Storage temperature range		-40	125		
T <sub>C</sub>	Operating case temperature		-40	125		
Torque	Mounting torque	For terminals	M2.5	0.4	0.6	N.m
			M4	2	3	
			M5	2	3.5	
		To heatsink	M6	3	5	
L <sub>DC</sub>	Module stray inductance between V <sub>BUS</sub> and 0/V <sub>BUS</sub>			3	nH	
Wt	Package weight			320	g	

The following table shows the temperature sensor NTC of MSCSM120AM03CT6LIAG device.

**Table 7 • Temperature Sensor NTC**

Symbol	Characteristics		Min	Typ	Max	Unit
R <sub>25</sub>	Resistance at 25°C			50		kΩ
ΔR <sub>25</sub> /R <sub>25</sub>				5		%
B <sub>25/85</sub>	T <sub>25</sub> = 298.15 K			3952		K
ΔB/B	T <sub>C</sub> = 100°C			4		%

$$R_T = \frac{R_{25}}{\exp \left[ B_{25/85} \left( \frac{1}{T_{25}} - \frac{1}{T} \right) \right]}$$

T: Thermistor temperature  
R<sub>T</sub>: Thermistor value at T

### 3.4 SiC MOSFET Performance Curves

The following images show the SiC MOSFET performance curves of the MSCSM120AM03CT6LIAG device.

**Figure 3 • Maximum Thermal Impedance**

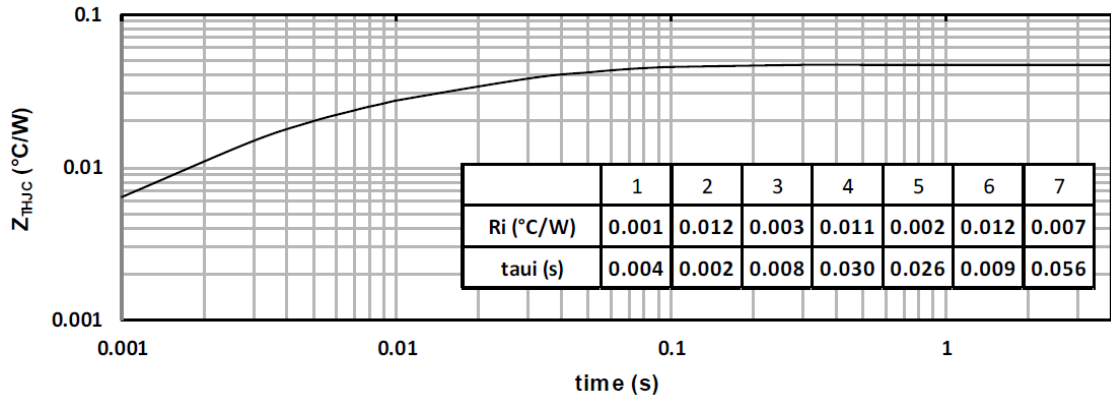

**Figure 4 • Output Characteristics, T<sub>J</sub> = 25 °C**

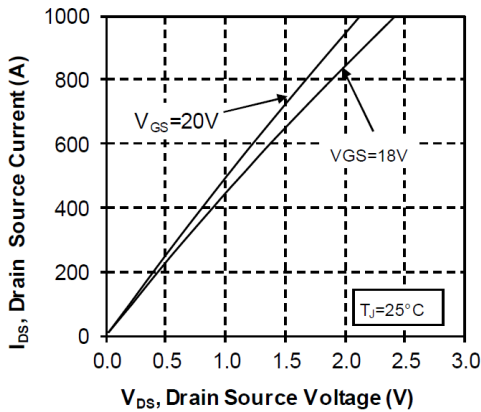

**Figure 5 • Output Characteristics, T<sub>J</sub> = 175 °C**

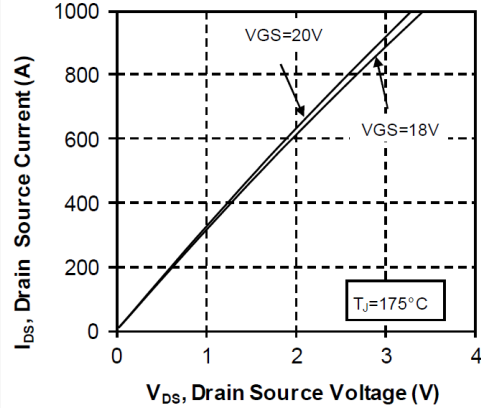

**Figure 6 • Normalized R<sub>DS(on)</sub> vs. Temperature**

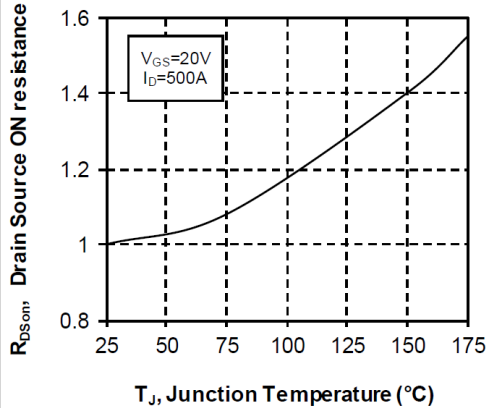

**Figure 7 • Transfer Characteristics**

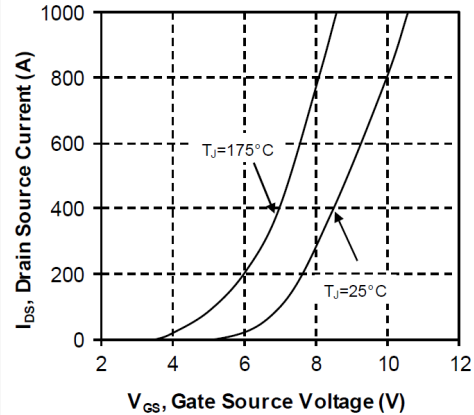

**Figure 8 • Switching Energy vs. Rg**

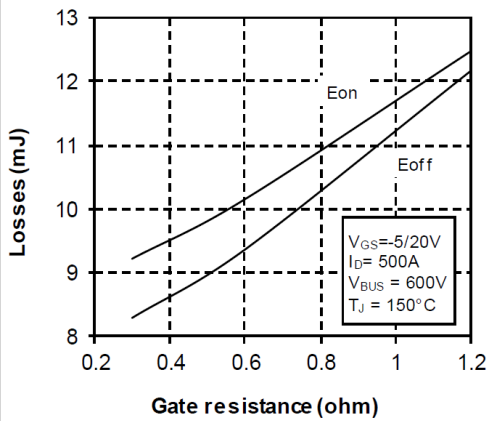

**Figure 9 • Switching Energy vs. Current**

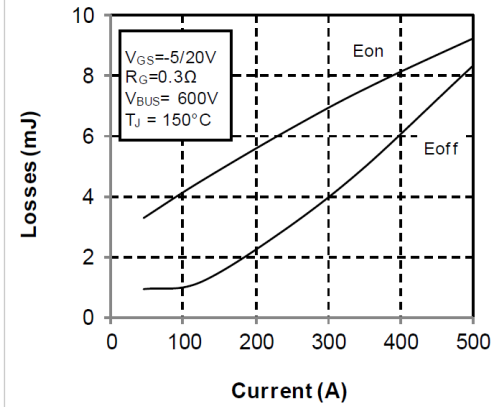

**Figure 10 • Capacitance vs. Drain Source Voltage**

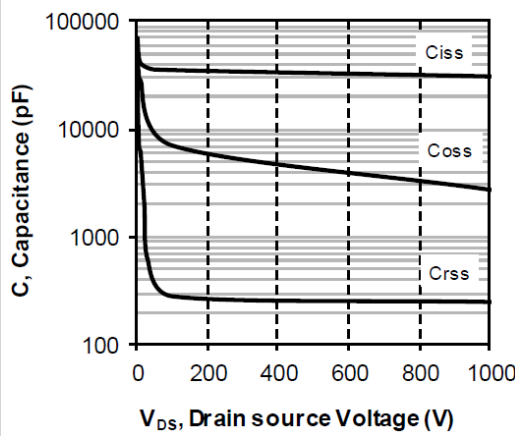

**Figure 11 • Gate Charge vs. Gate Source Voltage**

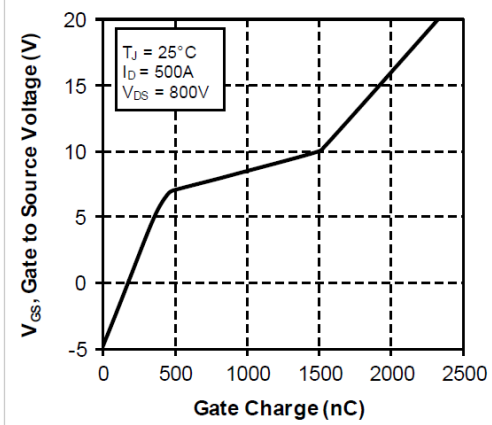

**Figure 12 • Body Diode Characteristics, TJ=25 °C**

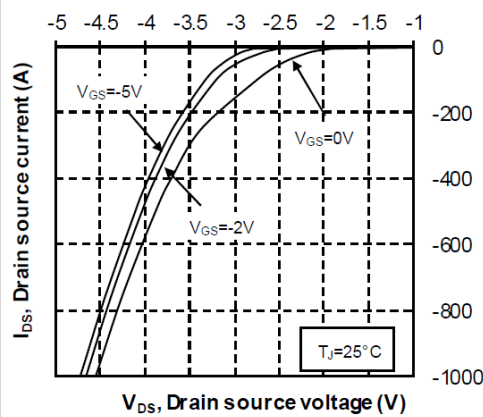

**Figure 13 • 3<sup>rd</sup> Quadrant Characteristics, TJ=25 °C**

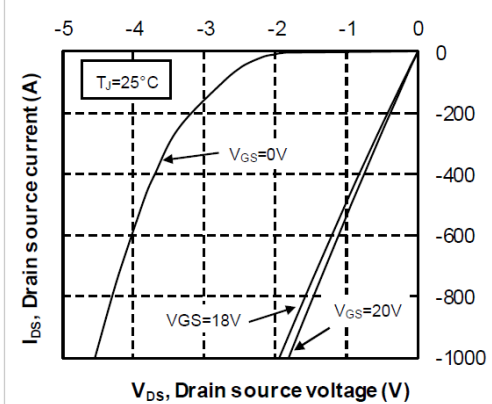

**Figure 14 • Body Diode Characteristics,  $T_J=175^\circ\text{C}$**

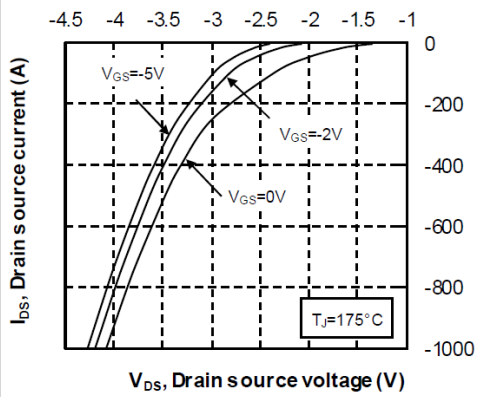

**Figure 15 • 3<sup>rd</sup> Quadrant Characteristics,  $T_J=175^\circ\text{C}$**

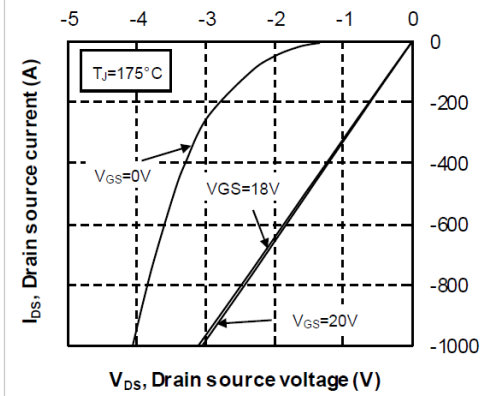

**Figure 16 • Operating Frequency vs. Drain Current**

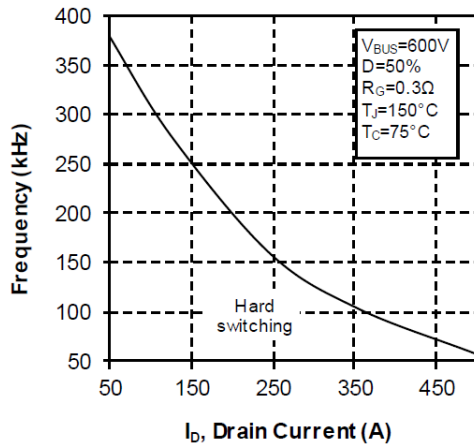

### 3.5 SiC Diode Performance Curves

The following images show the SiC diode performance curves of MSCSM120AM03CT6LIAG device.

**Figure 17 • Maximum Thermal Impedance**

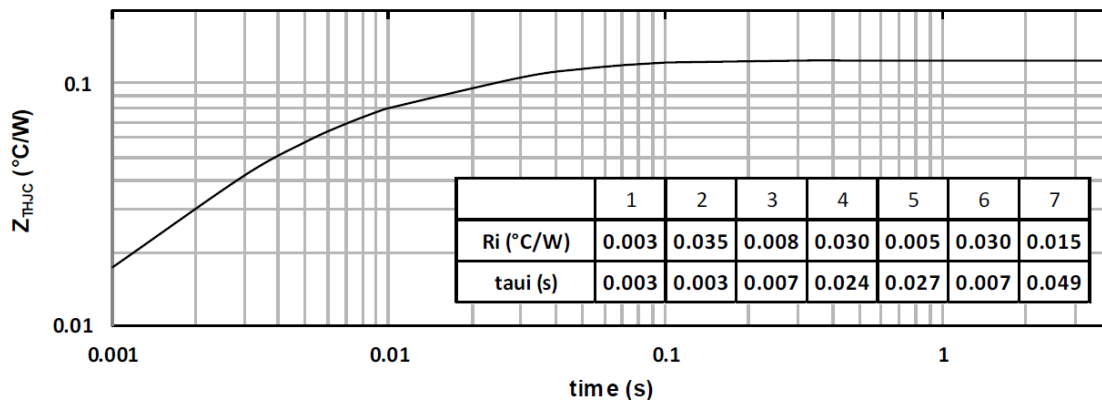

**Figure 18 • Forward Characteristics**

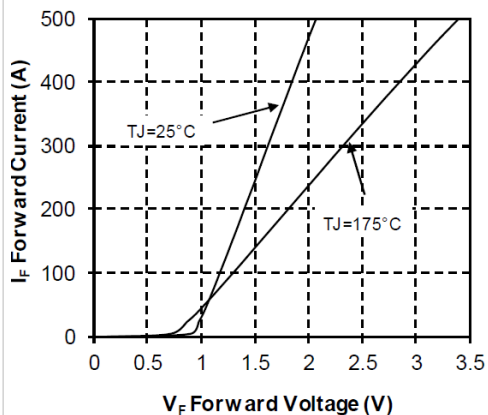

**Figure 19 • Capacitance vs. Reverse Voltage**

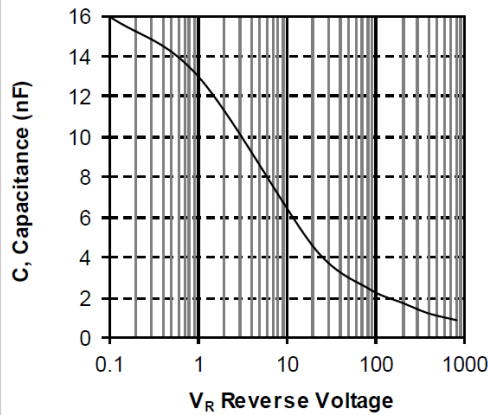

## 4 Package Specification

The following section shows the package specification of MSCSM120AM03CT6LIAG device.

### 4.1 Package Outline Drawing

The following image illustrates the package outline drawing of MSCSM120AM03CT6LIAG device. The dimensions are in millimeters.

Figure 20 • Package Outline Drawing

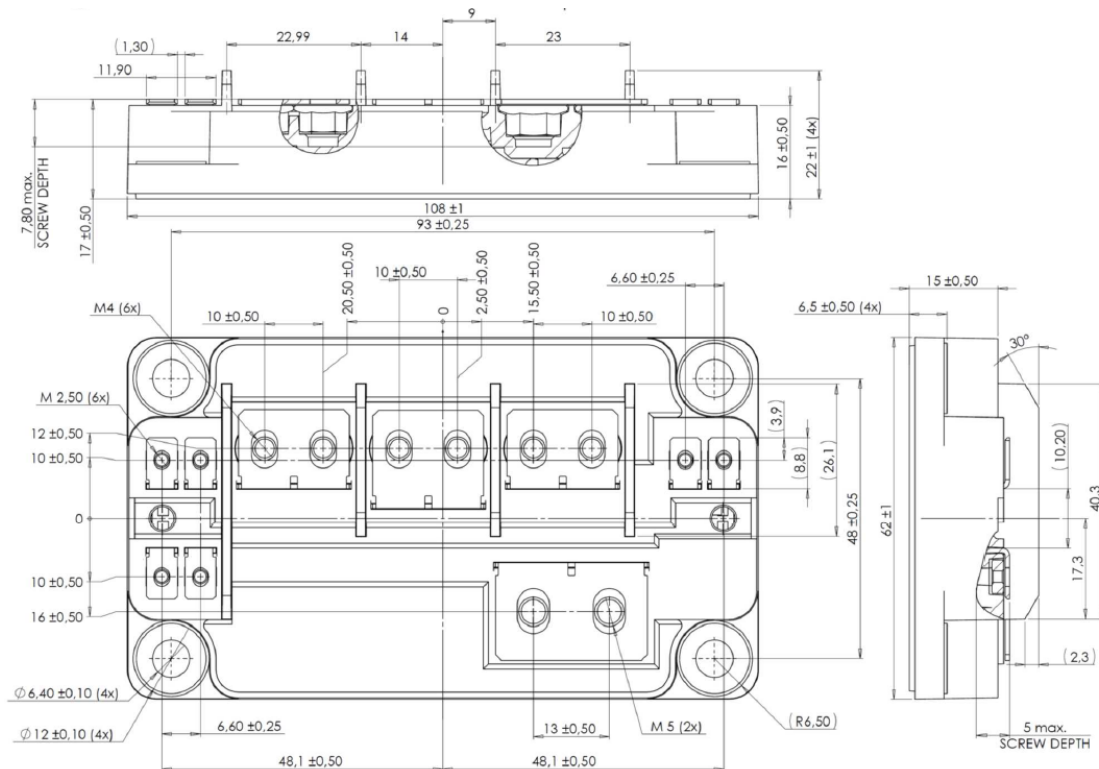

**Note:**

See [AN1911—Mounting instructions for SP6 Low inductance Power Module](#) application note.

**Microsemi**

2355 W. Chandler Blvd.  
 Chandler, AZ 85224 USA

Within the USA: +1 (480) 792-7200  
 Fax: +1 (480) 792-7277

www.microsemi.com © 2020 Microsemi and its corporate affiliates. All rights reserved. Microsemi and the Microsemi logo are trademarks of Microsemi Corporation and its corporate affiliates. All other trademarks and service marks are the property of their respective owners.

Microsemi's product warranty is set forth in Microsemi's Sales Order Terms and Conditions. Information contained in this publication is provided for the sole purpose of designing with and using Microsemi products. Information regarding device applications and the like is provided only for your convenience and may be superseded by updates. Buyer shall not rely on any data and performance specifications or parameters provided by Microsemi. It is your responsibility to ensure that your application meets with your specifications. THIS INFORMATION IS PROVIDED "AS IS." MICROSEMI MAKES NO REPRESENTATIONS OR WARRANTIES OF ANY KIND WHETHER EXPRESS OR IMPLIED, WRITTEN OR ORAL, STATUTORY OR OTHERWISE, RELATED TO THE INFORMATION, INCLUDING BUT NOT LIMITED TO ITS CONDITION, QUALITY, PERFORMANCE, NON-INFRINGEMENT, MERCHANTABILITY OR FITNESS FOR A PARTICULAR PURPOSE. IN NO EVENT WILL MICROSEMI BE LIABLE FOR ANY INDIRECT, SPECIAL, PUNITIVE, INCIDENTAL OR CONSEQUENTIAL LOSS, DAMAGE, COST OR EXPENSE WHATSOEVER RELATED TO THIS INFORMATION OR ITS USE, HOWEVER CAUSED, EVEN IF MICROSEMI HAS BEEN ADVISED OF THE POSSIBILITY OR THE DAMAGES ARE FORESEEABLE. TO THE FULLEST EXTENT ALLOWED BY LAW, MICROSEMI'S TOTAL LIABILITY ON ALL CLAIMS IN RELATED TO THIS INFORMATION OR ITS USE WILL NOT EXCEED THE AMOUNT OF FEES, IF ANY, YOU PAID DIRECTLY TO MICROSEMI FOR THIS INFORMATION. Use of Microsemi devices in life support, mission-critical equipment or applications, and/or safety applications is entirely at the buyer's risk, and the buyer agrees to defend and indemnify Microsemi from any and all damages, claims, suits, or expenses resulting from such use. No licenses are conveyed, implicitly or otherwise, under any Microsemi intellectual property rights unless otherwise stated.

Microsemi Corporation, a subsidiary of Microchip Technology Inc. (Nasdaq: MCHP), and its corporate affiliates are leading providers of smart, connected and secure embedded control solutions. Their easy-to-use development tools and comprehensive product portfolio enable customers to create optimal designs which reduce risk while lowering total system cost and time to market. These solutions serve more than 120,000 customers across the industrial, automotive, consumer, aerospace and defense, communications and computing markets. Headquartered in Chandler, Arizona, the company offers outstanding technical support along with dependable delivery and quality. Learn more at [www.microsemi.com](http://www.microsemi.com).

MSCC-0344-DS-01073-1.0-0120

## X-ON Electronics

Largest Supplier of Electrical and Electronic Components

*Click to view similar products for [Discrete Semiconductor Modules](#) category:*

*Click to view products by [Microchip](#) manufacturer:*

Other Similar products are found below :

[M252511FV](#) [DD260N12K-A](#) [DD380N16A](#) [DD89N1600K-A](#) [APT2X21DC60J](#) [APT58M80J](#) [B522F-2-YEC](#) [MSTC90-16](#) [25.163.0653.1](#)  
[25.163.2453.0](#) [25.163.4253.0](#) [25.190.2053.0](#) [25.194.3453.0](#) [25.320.4853.1](#) [25.320.5253.1](#) [25.326.3253.1](#) [25.326.3553.1](#) [25.330.1653.1](#)  
[25.330.4753.1](#) [25.330.5253.1](#) [25.334.3253.1](#) [25.334.3353.1](#) [25.350.2053.0](#) [25.352.4753.1](#) [25.522.3253.0](#) [T483C](#) [T484C](#) [T485F](#) [T485H](#)  
[T512F-YEB](#) [T513F](#) [T514F](#) [T554](#) [T612FSE](#) [25.161.3453.0](#) [25.179.2253.0](#) [25.194.3253.0](#) [25.325.1253.1](#) [25.326.4253.1](#) [25.330.0953.1](#)  
[25.332.4353.1](#) [25.350.1653.0](#) [25.350.2453.0](#) [25.352.1453.0](#) [25.352.1653.0](#) [25.352.2453.0](#) [25.352.5453.1](#) [25.522.3353.0](#) [25.602.4053.0](#)  
[25.640.5053.0](#)