

**MSCSM120AM11CT3AG**  
**Datasheet**  
**Phase Leg SiC MOSFET Power Module**

January 2020



---

a  **MICROCHIP** company

# Contents

---

<b>1 Revision History.....</b>	<b>1</b>
1.1 Revision 1.0.....	1
<b>Product Overview.....</b>	<b>2</b>
2.1 Features.....	3
2.2 Benefits.....	3
2.3 Applications.....	3
<b>Electrical Specifications.....</b>	<b>4</b>
3.1 SiC MOSFET Characteristics (Per MOSFET).....	4
3.2 SiC Schottky Diode Ratings Characteristics (Per SiC Diode).....	6
3.3 Thermal Package Characteristics.....	6
3.4 Typical SiC MOSFET Performance Curves.....	8
3.5 Typical SiC Diode Performance Curves.....	11
<b>Package Specifications.....</b>	<b>12</b>

# Tables

---

Table 1 • Absolute Maximum Ratings.....	4
Table 2 • Electrical Characteristics.....	4
Table 3 • Dynamic Characteristics.....	5
Table 4 • Body Diode Ratings and Characteristics.....	5
Table 5 • SiC Schottky Diode Ratings and Characteristics.....	6
Table 6 • Package Characteristics.....	6
Table 7 • Temperature Sensor NTC1.....	7

# Figures

---

Figure 1 • MSCSM120AM11CT3AG Electrical Schematic.....2

Figure 2 • MSCSM120AM11CT3AG Pinout Location.....2

Figure 3 • Maximum Thermal Impedance.....8

Figure 4 • Output Characteristics,  $T_J = 25\text{ }^\circ\text{C}$ .....8

Figure 5 • Output Characteristics,  $T_J = 175\text{ }^\circ\text{C}$ .....8

Figure 6 • Normalized  $R_{DS(on)}$  vs. Temperature.....8

Figure 7 • Transfer Characteristics.....8

Figure 8 • Switching Energy vs.  $R_g$ .....9

Figure 9 • Switching Energy vs. Current.....9

Figure 10 • Capacitance vs. Drain Source Voltage.....9

Figure 11 • Gate Charge vs. Gate Source Voltage.....9

Figure 12 • Body Diode Characteristics,  $T_J = 25\text{ }^\circ\text{C}$ .....9

Figure 13 • 3rd Quadrant Characteristics,  $T_J = 25\text{ }^\circ\text{C}$ .....9

Figure 14 • Body Diode Characteristics,  $T_J = 175\text{ }^\circ\text{C}$ .....10

Figure 15 • 3rd Quadrant Characteristics,  $T_J = 175\text{ }^\circ\text{C}$ .....10

Figure 16 • Operating Frequency vs. Drain Current.....10

Figure 17 • Maximum Thermal Impedance.....11

Figure 18 • Forward Characteristics.....11

Figure 19 • Capacitance vs. Reverse Voltage.....11

Figure 20 • Package Outline.....12

# 1 Revision History

---

The revision history describes the changes that were implemented in the document. The changes are listed by revision, starting with the most current publication.

## 1.1 Revision 1.0

Revision 1.0 is the initial release of this document, published in January 2020.

## 2 Product Overview

The MSCSM120AM11CT3AG is a phase leg 1200 V/254 A full Silicon Carbide power module.

**Figure 1 • MSCSM120AM11CT3AG Electrical Schematic**

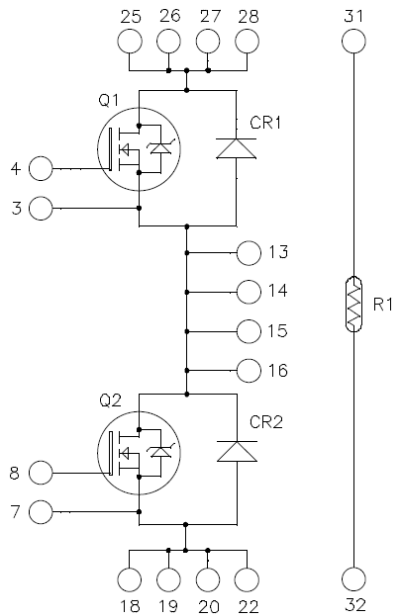

**Figure 2 • MSCSM120AM11CT3AG Pinout Location**

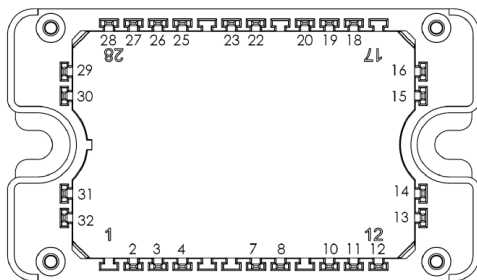

Pins 25 to 28 must be shorted together  
 Pins 13 to 16 must be shorted together  
 Pins 18/19/20/22 must be shorted together

All ratings at  $T_j = 25\text{ }^\circ\text{C}$  unless otherwise specified.

**Caution:** These devices are sensitive to electrostatic discharge. Proper handling procedures should be followed.

## 2.1 Features

The following are key features of the MSCSM120AM11CT3AG device:

- SiC Power MOSFET
  - High-speed switching
  - Low RDS(on)
  - Ultra low loss
- Silicon carbide (SiC) Schottky diode
  - Zero reverse recovery
  - Zero forward recovery
  - Temperature-independent switching behavior
  - Positive temperature coefficient on VF
- Low stray inductance
- Kelvin source for easy drive
- Internal thermistor for temperature monitoring
- Aluminum nitride (AlN) substrate for improved thermal performance

## 2.2 Benefits

The following are benefits of the MSCSM120AM11CT3AG device:

- High efficiency converters
- Outstanding performance at high frequency operation
- Direct mounting to heatsink (isolated package)
- Low junction-to-case thermal resistance
- Solderable terminals both for power and signal for easy PCB mounting
- Low profile
- RoHS Compliant

## 2.3 Applications

The MSCSM120AM11CT3AG device is designed for the following applications:

- Welding converters
- Switched Mode Power Supplies
- Uninterruptible Power Supplies
- EV motor and traction drive

## 3 Electrical Specifications

This section shows the electrical specifications of the MSCSM120AM11CT3AG device.

### 3.1 SiC MOSFET Characteristics (Per MOSFET)

This section describes the electrical characteristics of the MSCSM120AM11CT3AG device.

**Table 1 • Absolute Maximum Ratings**

Symbol	Parameter	Maximum Ratings	Unit
$V_{DSS}$	Drain-source voltage	1200	V
$I_D$	Continuous drain current	$T_C = 25\text{ }^\circ\text{C}$	254 <sup>1</sup>
		$T_C = 80\text{ }^\circ\text{C}$	202 <sup>1</sup>
$I_{DM}$	Pulsed drain current	500	
$V_{GS}$	Gate-source voltage	-10/25	V
$R_{Dson}$	Drain-source ON resistance	10.4	m $\Omega$
$P_D$	Power dissipation	$T_C = 25\text{ }^\circ\text{C}$	1067

**Note:**

1. Specification of SiC MOSFET device but output current must be limited due to the size of power connectors.

**Table 2 • Electrical Characteristics**

Symbol	Characteristic	Test Conditions	Min	Typ	Max	Unit
$I_{DSS}$	Zero gate voltage drain current	$V_{GS} = 0\text{ V}$ ; $V_{DS} = 1200\text{ V}$		30	300	$\mu\text{A}$
$R_{Dson}$	Drain-source on resistance	$V_{GS} = 20\text{ V}$ $I_D = 120\text{ A}$	$T_J = 25\text{ }^\circ\text{C}$	8.4	10.4	m $\Omega$
			$T_J = 175\text{ }^\circ\text{C}$	13.4		
$V_{GS(th)}$	Gate threshold voltage	$V_{GS} = V_{DS}$ , $I_D = 3\text{ mA}$	1.8	2.8		V
$I_{GSS}$	Gate-source leakage current	$V_{GS} = 20\text{ V}$ , $V_{DS} = 0\text{ V}$			300	nA



**Table 3 • Dynamic Characteristics**

Symbol	Characteristic	Test Conditions	Min	Typ	Max	Unit
$C_{iss}$	Input capacitance	$V_{GS} = 0\text{ V}$		9060		pF
$C_{oss}$	Output capacitance	$V_{DS} = 1000\text{ V}$ $f = 1\text{ MHz}$		810		
$C_{rss}$	Reverse transfer capacitance			75		
$Q_g$	Total gate charge	$V_{GS} = -5/20\text{ V}$		696		nC
$Q_{gs}$	Gate–source charge	$V_{Bus} = 800\text{ V}$ $I_D = 120\text{ A}$		123		
$Q_{gd}$	Gate–drain charge			150		
$T_{d(on)}$	Turn-on delay time	$V_{GS} = -5/20\text{ V}$		30		ns
$T_r$	Rise time	$V_{Bus} = 600\text{ V}$ $I_D = 150\text{ A}$		30		
$T_{d(off)}$	Turn-off delay time	$R_{Gon} = 2.7\Omega$ ; $R_{Goff} = 1.6\Omega$		50		
$T_f$	Fall time			25		
$E_{on}$	Turn on energy	Inductive Switching $V_{GS} = -5/20\text{ V}$	$T_J = 150\text{ }^\circ\text{C}$	3		mJ
$E_{off}$	Turn off energy	$V_{Bus} = 600\text{ V}$ $I_D = 150\text{ A}$ $R_{Gon} = 2.7\Omega$ $R_{Goff} = 1.6\Omega$	$T_J = 150\text{ }^\circ\text{C}$	2		mJ
$R_{Gint}$	Internal gate resistance			2		$\Omega$
$R_{thJC}$	Junction-to-case thermal resistance				0.141	$^\circ\text{C/W}$

**Table 4 • Body Diode Ratings and Characteristics**

Sym- bol	Characteristic	Test Conditions	Min	Typ	Max	Unit
$V_{SD}$	Diode forward voltage	$V_{GS} = 0\text{ V}$ ; $I_{SD} = 120\text{ A}$		4		V
		$V_{GS} = -5\text{ V}$ ; $I_{SD} = 120\text{ A}$		4.2		
$t_{rr}$	Reverse recovery time	$I_{SD} = 120\text{ A}$ ; $V_{GS} = -5\text{ V}$ ; $V_R = 800\text{ V}$ ; $diF/dt = 3000\text{ A}/\mu\text{s}$		90		ns
$Q_{rr}$	Reverse recovery charge			1650		nC
$I_{rr}$	Reverse recovery current			40.5		A

### 3.2 SiC Schottky Diode Ratings Characteristics (Per SiC Diode)

This section shows the SiC Schottky diode ratings and characteristics of the MSCSM120AM11CT3AG device.

**Table 5 • SiC Schottky Diode Ratings and Characteristics**

Symbol	Characteristic	Test Conditions		Min	Typ	Max	Unit
$V_{RRM}$	Peak repetitive reverse voltage					1200	V
$I_{RRM}$	Reverse leakage current	$V_R = 1200\text{ V}$	$T_J = 25\text{ }^\circ\text{C}$		30	600	$\mu\text{A}$
			$T_J = 175\text{ }^\circ\text{C}$		450		
$I_F$	Forward current				90		A
$V_F$	Diode forward voltage	$I_F = 90\text{ A}$	$T_J = 25\text{ }^\circ\text{C}$		1.5	1.8	V
			$T_J = 175\text{ }^\circ\text{C}$		2.1		
$Q_C$	Total capacitive charge	$I_F = 90\text{ A}$			390		nC
C	Total capacitance	$f = 1\text{ MHz}, V_R = 400\text{ V}$			423		$\mu\text{F}$
		$f = 1\text{ MHz}, V_R = 800\text{ V}$			315		
$R_{thJC}$	Junction-to-case thermal resistance					0.333	$^\circ\text{C/W}$

### 3.3 Thermal Package Characteristics

This section shows the thermal and package characteristics of the MSCSM120AM11CT3AG device.

**Table 6 • Package Characteristics**

Symbol	Characteristic			Min	Max	Unit
$V_{ISOL}$	RMS isolation voltage, any terminal to case $t = 1\text{ min}$ , 50/60 Hz			4000		V
$T_J$	Operating junction temperature range			-40	175	$^\circ\text{C}$
$T_{JOP}$	Recommended junction temperature under switching conditions			-40	$T_{Jmax} - 25$	$^\circ\text{C}$
$T_{STG}$	Storage temperature range			-40	125	$^\circ\text{C}$
$T_C$	Operating case temperature			-40	125	$^\circ\text{C}$
Torque	Mounting torque	To heatsink	M4	2	3	N.m
Wt	Package weight				110	g

**Table 7 • Temperature Sensor NTC<sup>1</sup>**

Symbol	Characteristic	Min	Typ	Max	Unit
R <sub>25</sub>	Resistance at 25 °C		50		kΩ
ΔR <sub>25</sub> /R <sub>25</sub>			5		%
B <sub>25/85</sub>	T <sub>25</sub> = 298.15 K		3952		K
ΔB/B	T <sub>C</sub> = 100 °C		4		%

$$R_T = \frac{R_{25}}{\exp\left[B_{25/85}\left(\frac{1}{T_{25}} - \frac{1}{T}\right)\right]}$$

T: Thermistor temperature  
 R<sub>T</sub>: Thermistor value at T

**Note:**

1. See application note APT0406 on [www.microsemi.com](http://www.microsemi.com).

### 3.4 Typical SiC MOSFET Performance Curves

This section shows the typical performance curves of the MSCSM120AM11CT3AG SiC MOSFET.

**Figure 3 • Maximum Thermal Impedance**

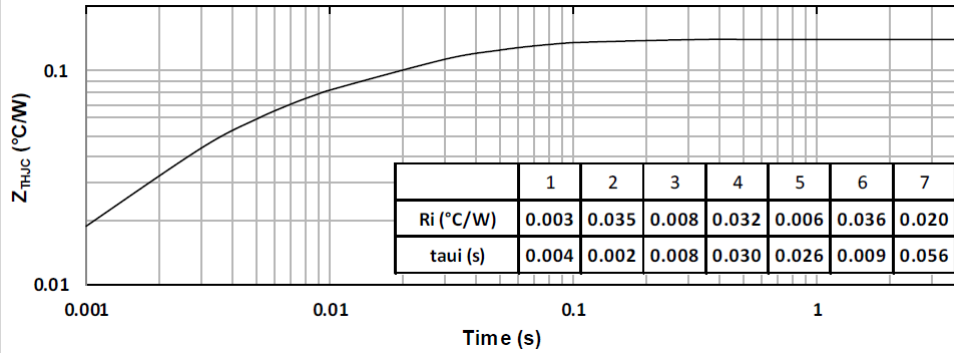

**Figure 4 • Output Characteristics, T<sub>J</sub> = 25 °C**

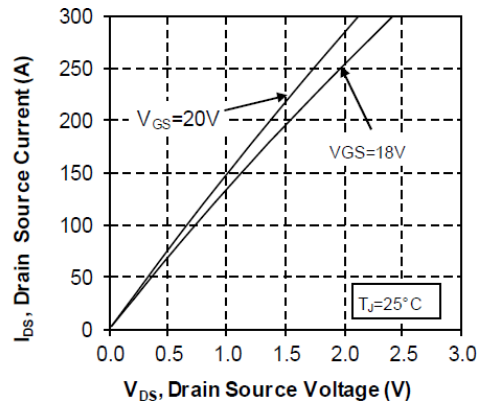

**Figure 5 • Output Characteristics, T<sub>J</sub> = 175 °C**

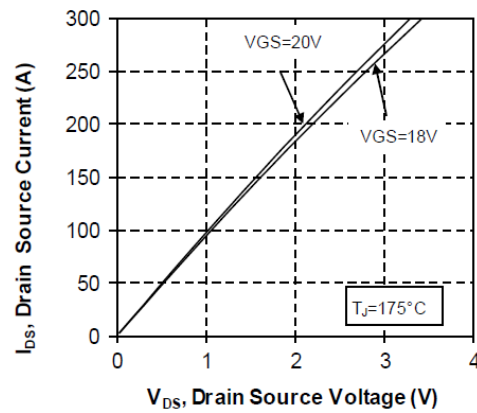

**Figure 6 • Normalized RDS(on) vs. Temperature**

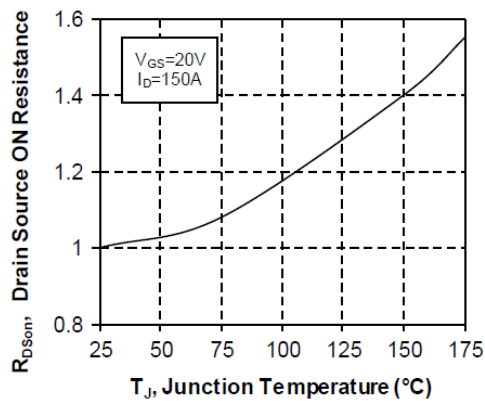

**Figure 7 • Transfer Characteristics**

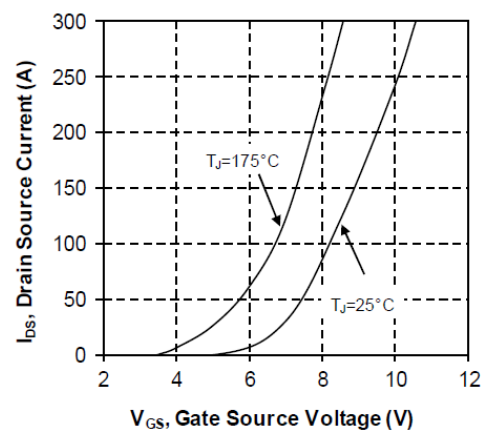

**Figure 8 • Switching Energy vs. Rg**

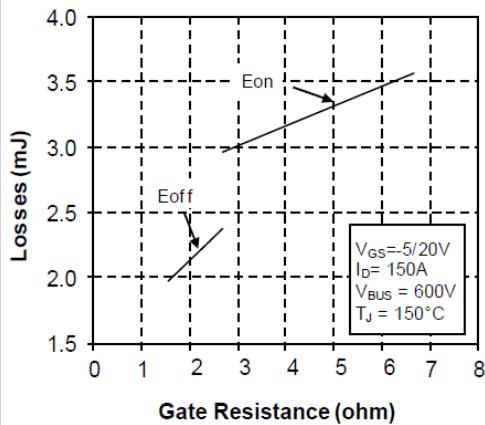

**Figure 9 • Switching Energy vs. Current**

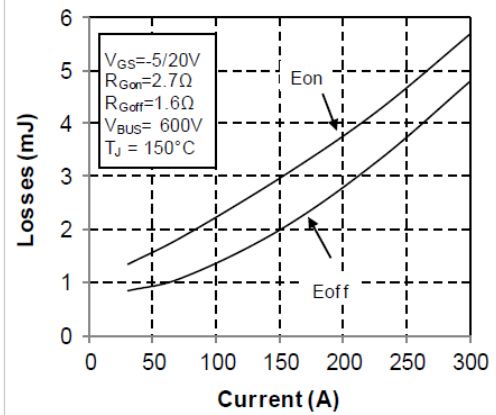

**Figure 10 • Capacitance vs. Drain Source Voltage**

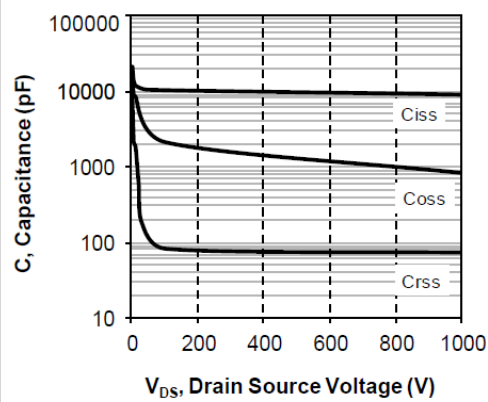

**Figure 11 • Gate Charge vs. Gate Source Voltage**

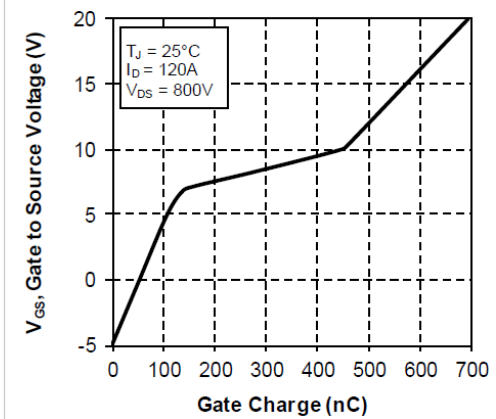

**Figure 12 • Body Diode Characteristics, TJ = 25 °C**

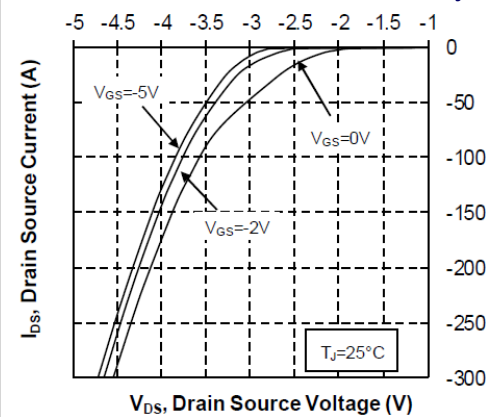

**Figure 13 • 3<sup>rd</sup> Quadrant Characteristics, TJ = 25 °C**

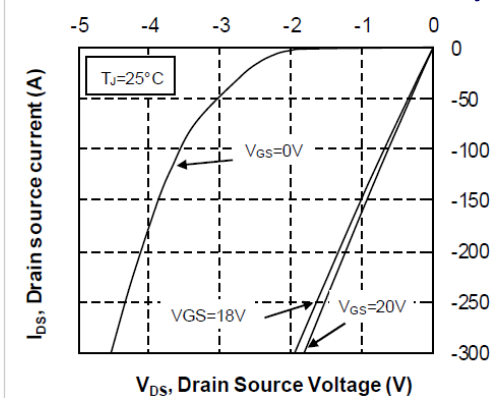

**Figure 14 • Body Diode Characteristics,  $T_J = 175^\circ\text{C}$**

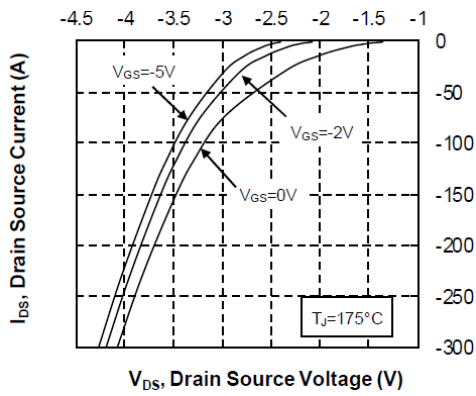

**Figure 15 • 3<sup>rd</sup> Quadrant Characteristics,  $T_J = 175^\circ\text{C}$**

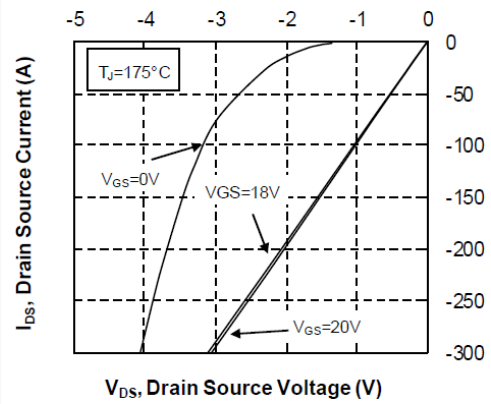

**Figure 16 • Operating Frequency vs. Drain Current**

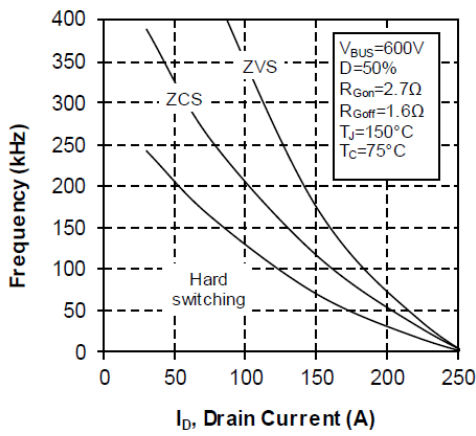

### 3.5 Typical SiC Diode Performance Curves

This section shows the typical performance curves of the MSCSM120AM11CT3AG SiC diode.

**Figure 17 • Maximum Thermal Impedance**

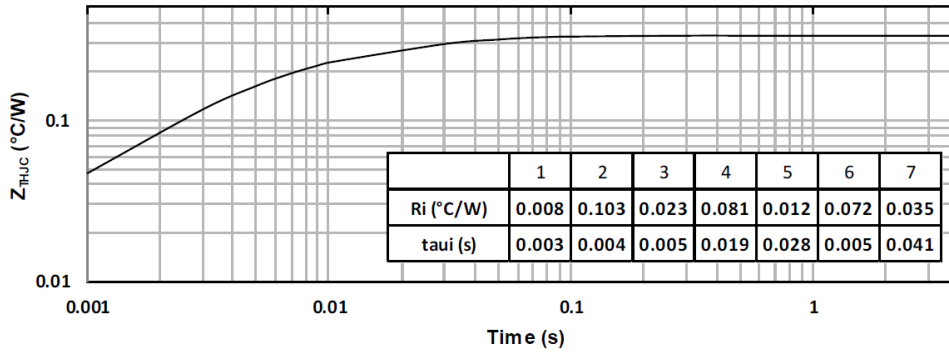

**Figure 18 • Forward Characteristics**

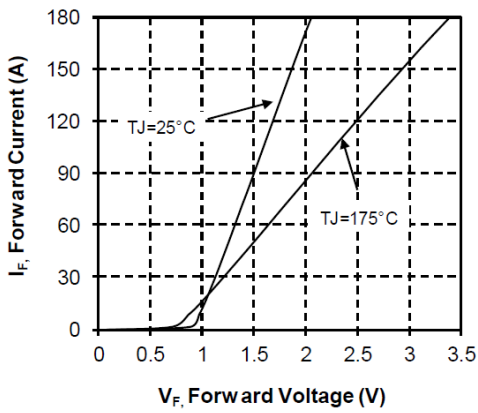

**Figure 19 • Capacitance vs. Reverse Voltage**

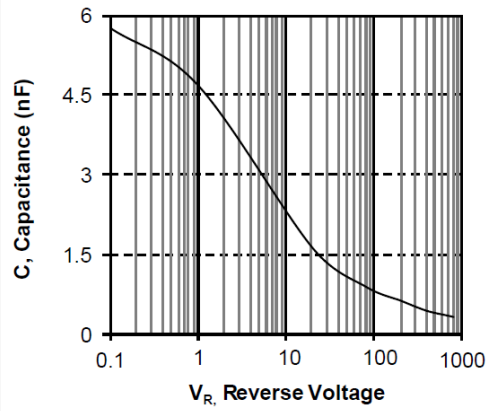

## 4 Package Specifications

This section shows the package outline of the MSCSM120AM11CT3AG device. All dimensions are in millimeters.

**Figure 20 • Package Outline**

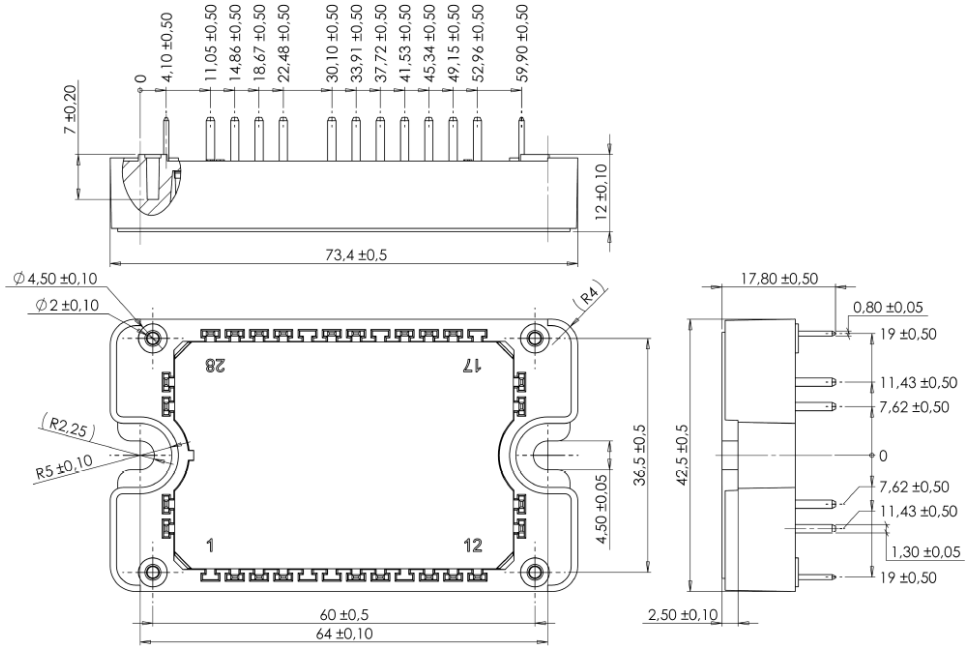

See application note 1906 – Mounting Instructions for SP3F Power Modules on [www.microsemi.com](http://www.microsemi.com).



**Microsemi**

2355 W. Chandler Blvd.  
Chandler, AZ 85224 USA

Within the USA: +1 (480) 792-7200  
Fax: +1 (480) 792-7277

www.microsemi.com © 2020 Microsemi and its corporate affiliates. All rights reserved. Microsemi and the Microsemi logo are trademarks of Microsemi Corporation and its corporate affiliates. All other trademarks and service marks are the property of their respective owners.

Microsemi's product warranty is set forth in Microsemi's Sales Order Terms and Conditions. Information contained in this publication is provided for the sole purpose of designing with and using Microsemi products. Information regarding device applications and the like is provided only for your convenience and may be superseded by updates. Buyer shall not rely on any data and performance specifications or parameters provided by Microsemi. It is your responsibility to ensure that your application meets with your specifications. THIS INFORMATION IS PROVIDED "AS IS." MICROSEMI MAKES NO REPRESENTATIONS OR WARRANTIES OF ANY KIND WHETHER EXPRESS OR IMPLIED, WRITTEN OR ORAL, STATUTORY OR OTHERWISE, RELATED TO THE INFORMATION, INCLUDING BUT NOT LIMITED TO ITS CONDITION, QUALITY, PERFORMANCE, NON-INFRINGEMENT, MERCHANTABILITY OR FITNESS FOR A PARTICULAR PURPOSE. IN NO EVENT WILL MICROSEMI BE LIABLE FOR ANY INDIRECT, SPECIAL, PUNITIVE, INCIDENTAL OR CONSEQUENTIAL LOSS, DAMAGE, COST OR EXPENSE WHATSOEVER RELATED TO THIS INFORMATION OR ITS USE, HOWEVER CAUSED, EVEN IF MICROSEMI HAS BEEN ADVISED OF THE POSSIBILITY OR THE DAMAGES ARE FORESEEABLE. TO THE FULLEST EXTENT ALLOWED BY LAW, MICROSEMI'S TOTAL LIABILITY ON ALL CLAIMS IN RELATED TO THIS INFORMATION OR ITS USE WILL NOT EXCEED THE AMOUNT OF FEES, IF ANY, YOU PAID DIRECTLY TO MICROSEMI FOR THIS INFORMATION. Use of Microsemi devices in life support, mission-critical equipment or applications, and/or safety applications is entirely at the buyer's risk, and the buyer agrees to defend and indemnify Microsemi from any and all damages, claims, suits, or expenses resulting from such use. No licenses are conveyed, implicitly or otherwise, under any Microsemi intellectual property rights unless otherwise stated.

Microsemi Corporation, a subsidiary of Microchip Technology Inc. (Nasdaq: MCHP), and its corporate affiliates are leading providers of smart, connected and secure embedded control solutions. Their easy-to-use development tools and comprehensive product portfolio enable customers to create optimal designs which reduce risk while lowering total system cost and time to market. These solutions serve more than 120,000 customers across the industrial, automotive, consumer, aerospace and defense, communications and computing markets. Headquartered in Chandler, Arizona, the company offers outstanding technical support along with dependable delivery and quality. Learn more at [www.microsemi.com](http://www.microsemi.com).

MSCC-0344-DS-01055-1.0-0120

## X-ON Electronics

Largest Supplier of Electrical and Electronic Components

*Click to view similar products for [Discrete Semiconductor Modules](#) category:*

*Click to view products by [Microchip](#) manufacturer:*

Other Similar products are found below :

[M252511FV](#) [DD260N12K-A](#) [DD380N16A](#) [DD89N1600K-A](#) [APT2X21DC60J](#) [APT58M80J](#) [B522F-2-YEC](#) [MSTC90-16](#) [25.163.0653.1](#)  
[25.163.2453.0](#) [25.163.4253.0](#) [25.190.2053.0](#) [25.194.3453.0](#) [25.320.4853.1](#) [25.320.5253.1](#) [25.326.3253.1](#) [25.326.3553.1](#) [25.330.1653.1](#)  
[25.330.4753.1](#) [25.330.5253.1](#) [25.334.3253.1](#) [25.334.3353.1](#) [25.350.2053.0](#) [25.352.4753.1](#) [25.522.3253.0](#) [T483C](#) [T484C](#) [T485F](#) [T485H](#)  
[T512F-YEB](#) [T513F](#) [T514F](#) [T554](#) [T612FSE](#) [25.161.3453.0](#) [25.179.2253.0](#) [25.194.3253.0](#) [25.325.1253.1](#) [25.326.4253.1](#) [25.330.0953.1](#)  
[25.332.4353.1](#) [25.350.1653.0](#) [25.350.2453.0](#) [25.352.1453.0](#) [25.352.1653.0](#) [25.352.2453.0](#) [25.352.5453.1](#) [25.522.3353.0](#) [25.602.4053.0](#)  
[25.640.5053.0](#)