

3-Phase Sinusoidal Sensorless Brushless Motor Driver

Features

- 180° Sinusoidal Drive for High Efficiency and Low Acoustic Noise
- Position Sensorless BLDC Drivers (no Hall Effect Sensor required)
- Integrated Power Transistors
- Supports 2V to 5.5V Power Supplies
- Programming Resistor (R_{PROG}) Settings to Fit Motor Constant (K_M) Range from 3.25 mV/Hz to 52 mV/Hz
- Direction Control:
 - Forward direction: connect DIR pin to GND or leave floating
 - Reverse direction: connect DIR pin to V_{BIAS} or 3V
- Speed Control through Power Supply Modulation (PSM) and/or Pulse-Width Modulation (PWM)
- Built-in Frequency Generator (FG Output Signal)
- Built-in Lockup Protection and Automatic Recovery Circuit
- Built-in Overcurrent Limitation
- Built-in Thermal Shutdown Protection
- Built-in Overvoltage Protection
- No External Tuning Required
- Available Package:
 - 10-Lead 3mm x 3mm UDFN

Applications

- Notebook CPU Cooling Fans
- 5V 3-Phase BLDC

Description

The MTD6505 device is a 3-phase, full-wave sensorless driver for brushless DC (BLDC) motors. It features 180° sinusoidal drive, high-torque output and silent drive. With the adaptive features, parameters and wide range of power supplies (2V to 5.5V), the MTD6505 is intended to cover a broad range of motor characteristics, while requiring minimum external components. Speed control can be achieved through either PSM or PWM.

The compact packaging and the minimal bill of materials make the MTD6505 device extremely cost-efficient in fan applications. For example, the CPU cooling fans in notebook computers require designs that provide low acoustic noise, low mechanical vibration, and are highly efficient. The frequency generator (FG) output enables precision speed control in closed-loop applications.

The MTD6505 device includes Lockup Protection mode to turn off the output current when the motor is in a lock condition, with an automatic recovery feature to restart the fan when the lock condition is removed. Motor overcurrent limitation and thermal shutdown protection are included for safety-enhanced operations.

The MTD6505 is available in a compact, thermally-enhanced, 10-lead 3 mm x 3 mm UDFN package.

Package Types

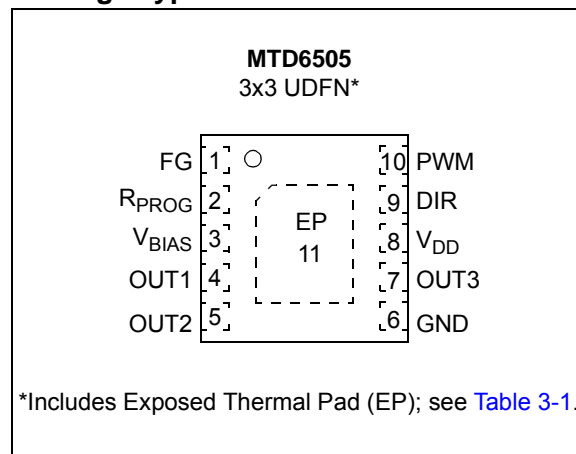

MTD6505

Functional Block Diagram

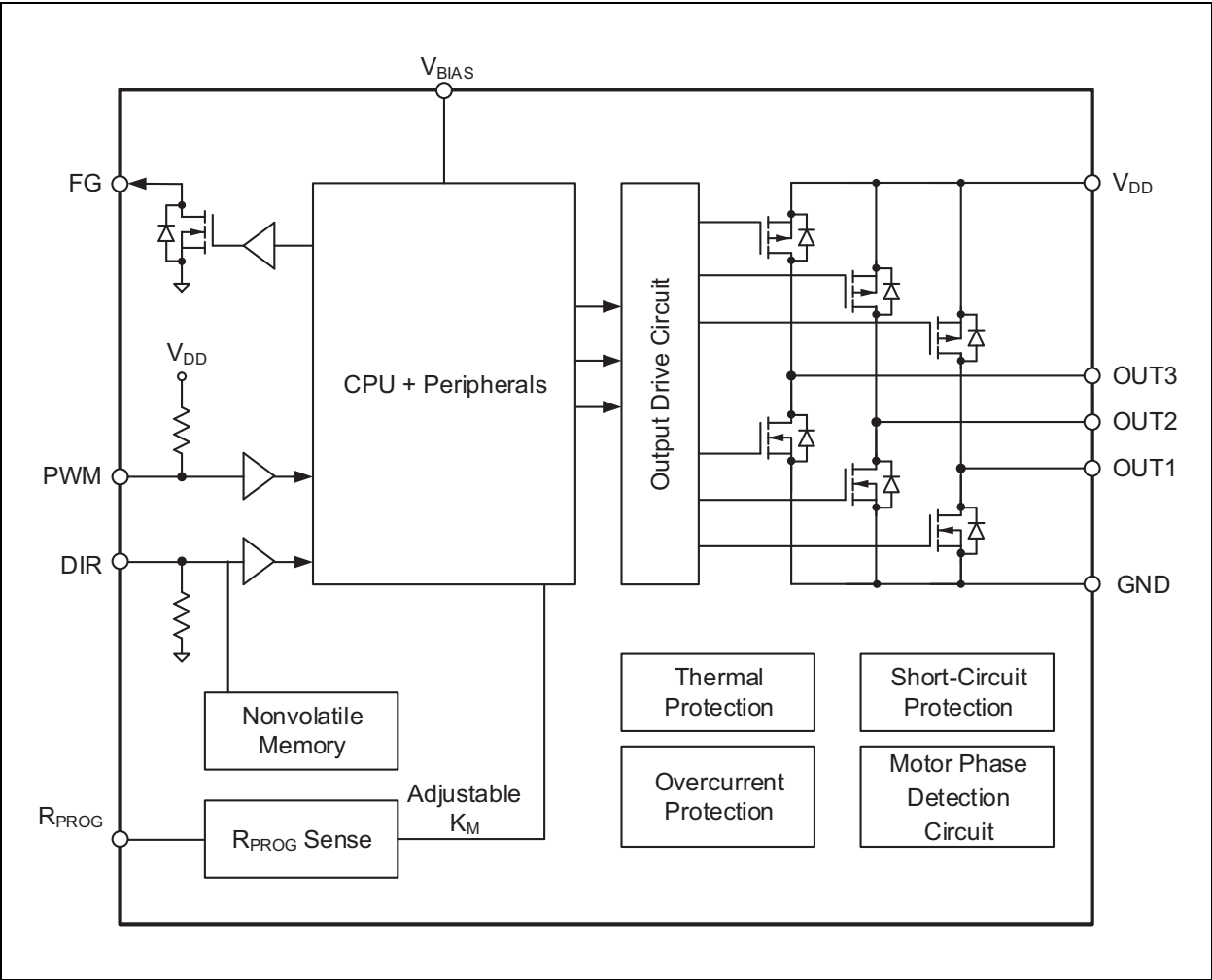

Typical Application

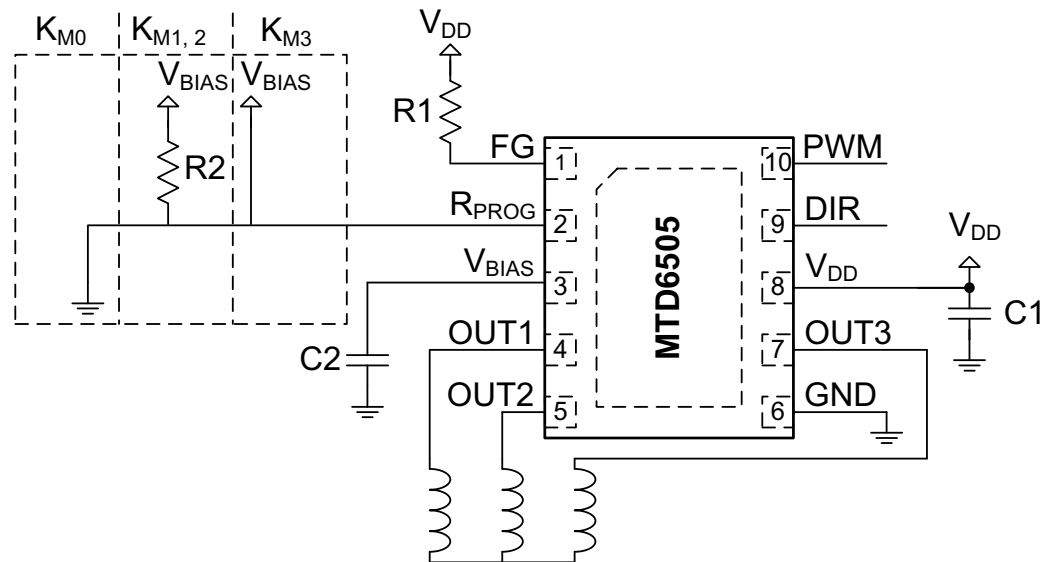

Recommended External Components for Typical Application

Element	Type/Value	Comment
C1	$\geq 1 \mu\text{F}$	Connect as close as possible to IC input pins
C2	$\geq 1 \mu\text{F}$	Connect as close as possible to IC input pins
R1	$\geq 10 \text{ k}\Omega$	Connect to V_{LOGIC} on microcontroller side (FG Pull-Up)
R2	3.9 k Ω or 24 k Ω	Select appropriate programming resistor value, see Table 4-2

MTD6505

NOTES:

1.0 ELECTRICAL CHARACTERISTICS

Absolute Maximum Ratings†

Power Supply Voltage (V_{DD_MAX})	-0.7 to +7.0V
Maximum Output Voltage (V_{OUT_MAX})	-0.7 to +7.0V
Maximum Output Current ⁽¹⁾ (I_{OUT_MAX})	1000 mA
FG Maximum Output Voltage (V_{FG_MAX})	-0.7 to +7.0V
FG Maximum Output Current (I_{FG_MAX})	5.0 mA
V_{BIAS} Maximum Voltage (V_{BIAS_MAX})	-0.7 to +4.0V
PWM Maximum Voltage (V_{PWM_MAX})	-0.7 to +7.0V
Allowable Power Dissipation ⁽²⁾ (P_{D_MAX})	1.5W
Maximum Junction Temperature (T_J)	+150°C
ESD protection on all pins	≥2 kV

† **Notice:** Stresses above those listed under “Maximum Ratings” may cause permanent damage to the device. This is a stress rating only and functional operation of the device at those or any other conditions above those indicated in the operational listings of this specification is not implied. Exposure to maximum rating conditions for extended periods may affect device reliability.

Note 1: I_{OUT} is also internally limited, according to the limits defined in the “**Electrical Characteristics**” table.

2: Reference Printed Circuit Board (PCB), according to JEDEC standard EIA/JESD 51-9.

ELECTRICAL CHARACTERISTICS

Electrical Specifications: Unless otherwise specified, all limits are established for $V_{DD} = 2.0V$ to $5.5V$, $T_A = +25^\circ C$

Parameters	Sym.	Min.	Typ.	Max.	Units	Conditions
Power Supply Voltage	V_{DD}	2	—	5.5	V	
Power Supply Current	I_{VDD}	—	5	10	mA	$V_{DD} = 5V$
Standby Current	I_{VDD_STB}	—	30	40	μA	PWM = 0V, $V_{DD} = 5V$ (Standby mode)
OUTX High Resistance	$R_{ON(H)}$	—	0.75	1.1	Ω	$I_{OUT} = 0.5A$, $V_{DD} = 5V$ Note 1
OUTX Low Resistance	$R_{ON(L)}$	—	0.75	1.3	Ω	$I_{OUT} = 0.5A$, $V_{DD} = 5V$ Note 1
OUTX Total Resistance	$R_{ON(H+L)}$	—	1.5	2.4	Ω	$I_{OUT} = 0.5A$, $V_{DD} = 5V$ Note 1
V_{BIAS} Internal Supply Voltage	V_{BIAS}	—	3	—	V	$V_{DD} = 3.2V$ to $5.5V$
		—	$V_{DD} - 0.2$	—	V	$V_{DD} < 3.2V$
PWM Input Frequency	f_{PWM}	1	—	100	kHz	
PWM Input H Level	V_{PWM_H}	$0.55 * V_{DD}$	—	V_{DD}	V	$V_{DD} \geq 4.5V$
PWM Input L Level	V_{PWM_L}	0	—	$0.2 * V_{DD}$	V	$V_{DD} \geq 4.5V$
PWM Internal Pull-Up Resistor	R_{PWM_0}	—	266	—	k Ω	PWM = 0V
PWM Internal Pull-Up Resistor	R_{PWM}	—	133	—	k Ω	PWM duty-cycle > 0%
DIR Input H Level	V_{DIR_H}	$V_{BIAS} - 0.5$	—	V_{BIAS}	V	$V_{DD} \geq 4.5V$
DIR Input L Level	V_{DIR_L}	0	—	$0.2 * V_{DD}$	V	$V_{DD} \geq 4.5V$
DIR Internal Pull-Down Resistor	R_{DIR}	100	—	200	k Ω	
FG Output Pin Low-Level Voltage	V_{OL_FG}	—	—	0.25	V	$I_{FG} = -1 mA$
FG Output Pin Leakage Current	I_{LH_FG}	-10	—	10	μA	$V_{FG} = 5.5V$
Lock Protection Operating Time	T_{RUN}	—	0.5	—	s	
Lock Protection Waiting Time	T_{WAIT}	4.5	5	5.5	s	Note 2
Overcurrent Protection	I_{OC_MOT}	—	750	—	mA	Note 3
Overvoltage Protection	V_{OV}	—	7.2	—	V	

MTD6505

ELECTRICAL CHARACTERISTICS (CONTINUED)

Electrical Specifications: Unless otherwise specified, all limits are established for $V_{DD} = 2.0V$ to $5.5V$, $T_A = +25^\circ C$						
Parameters	Sym.	Min.	Typ.	Max.	Units	Conditions
Short Protection on High Side	$I_{OC_SW_H}$	—	2.57	—	A	
Short Protection on Low Side	$I_{OC_SW_L}$	—	-2.83	—	A	
Thermal Shutdown	T_{SD}	—	170	—	$^\circ C$	
Thermal Shutdown Hysteresis	T_{SD_HYS}	—	25	—	$^\circ C$	

- Note 1:** Minimum and maximum parameters are not production tested and are specified by design and validation.
- Note 2:** Related to the internal oscillator frequency (see [Figure 2-1](#)).
- Note 3:** 750 mA is the standard option for MTD6505. Additional overcurrent protection levels are available upon request. Please contact factory for different overcurrent protection values.

TEMPERATURE SPECIFICATIONS

Electrical Specifications: Unless otherwise specified, all limits are established for $V_{DD} = 2.0V$ to $5.5V$, $T_A = +25^\circ C$.						
Parameters	Sym.	Min.	Typ.	Max.	Units	Conditions
Temperature Ranges						
Operating Temperature	T_{OPR}	-40	—	+125	$^\circ C$	
Storage Temperature Range	T_{STG}	-55	—	+150	$^\circ C$	
Thermal Package Resistances						
Thermal Resistance, 10LD-UDFN 3x3	θ_{JA}	—	96.6	—	$^\circ C/W$	
	θ_{JC}	—	12	—	$^\circ C/W$	

2.0 TYPICAL PERFORMANCE CURVES

Note: The graphs and tables provided following this note are a statistical summary based on a limited number of samples and are provided for informational purposes only. The performance characteristics listed herein are not tested or guaranteed. In some graphs or tables, the data presented may be outside the specified operating range (e.g., outside specified power supply range) and therefore outside the warranted range.

Note: Unless indicated, $T_A = +25^\circ\text{C}$, $V_{DD} = 2.0\text{V}$ to 5.5V , OUT1, 2, 3 and PWM open.

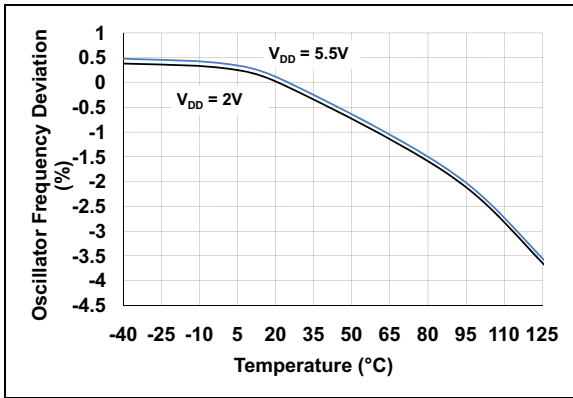

FIGURE 2-1: Oscillator Frequency Deviation vs. Temperature.

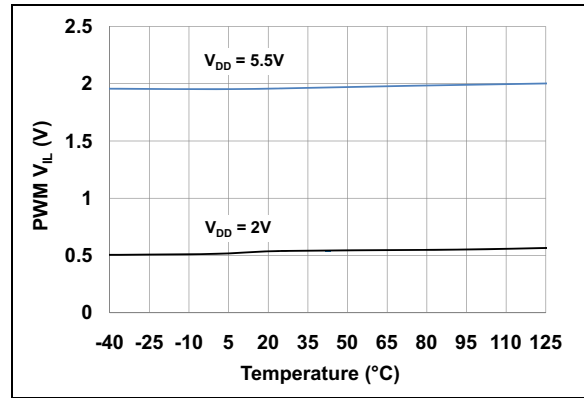

FIGURE 2-4: Inputs (PWM, DIR) V_{IL} vs. Temperature.

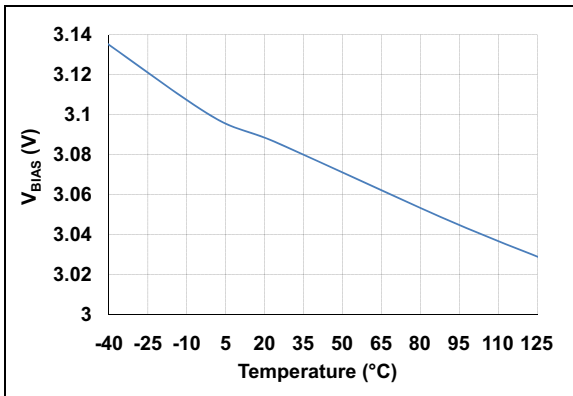

FIGURE 2-2: Internal Regulated Voltage (V_{BIAS}) vs. Temperature.

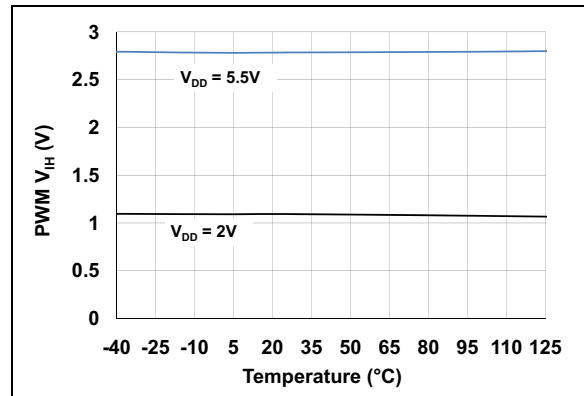

FIGURE 2-5: Inputs (PWM, DIR) V_{IH} vs. Temperature.

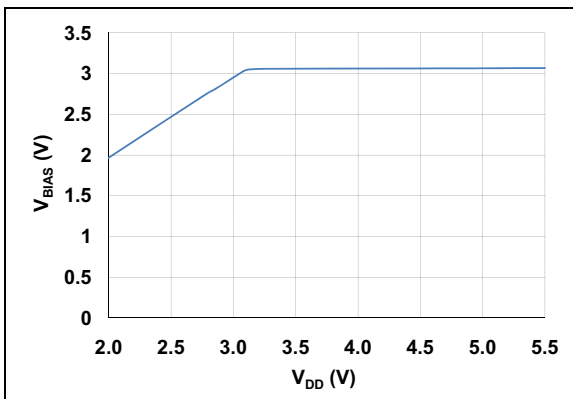

FIGURE 2-3: Internal Regulated Voltage (V_{BIAS}) vs. Supply Voltage (V_{DD}).

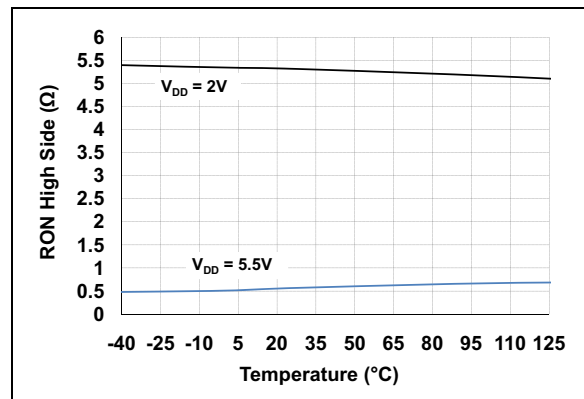

FIGURE 2-6: Outputs R_{ON} High-Side Resistance vs. Temperature.

MTD6505

Note: Unless indicated, $T_A = +25^\circ\text{C}$, $V_{DD} = 2.0\text{V}$ to 5.5V , OUT1, 2, 3 and PWM open.

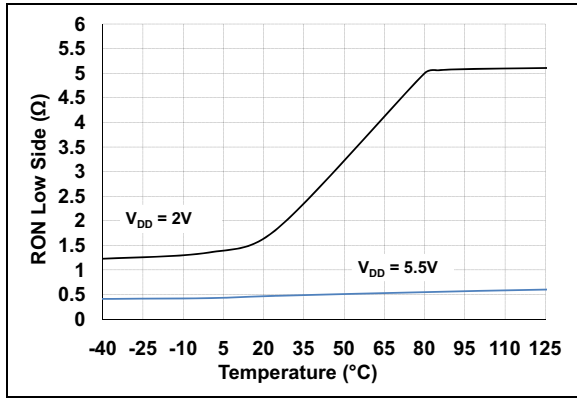

FIGURE 2-7: Outputs R_{ON} Low-Side Resistance vs. Temperature.

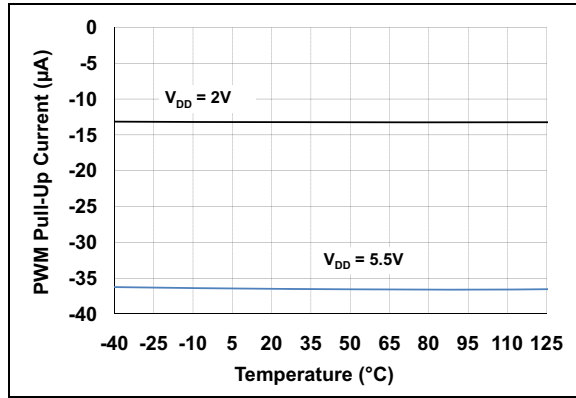

FIGURE 2-10: PWM Pull-Up Current vs. Temperature.

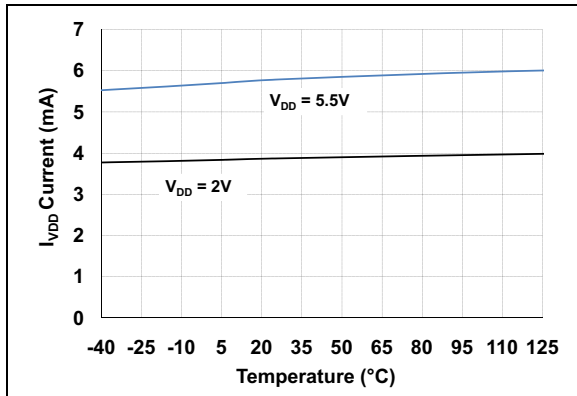

FIGURE 2-8: Supply Current vs. Temperature.

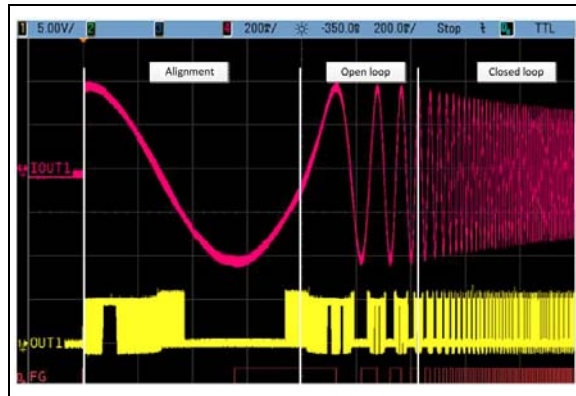

FIGURE 2-11: Typical Output on Start-Up.

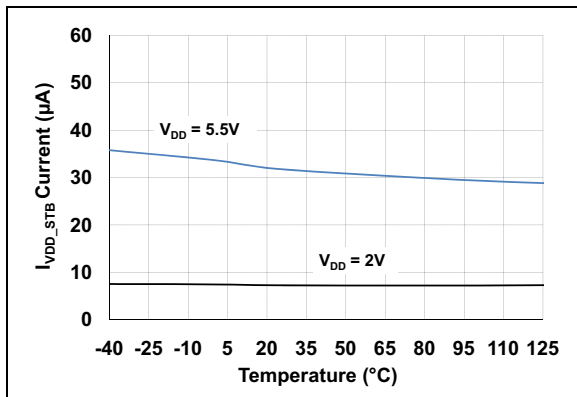

FIGURE 2-9: Standby Current vs. Temperature.

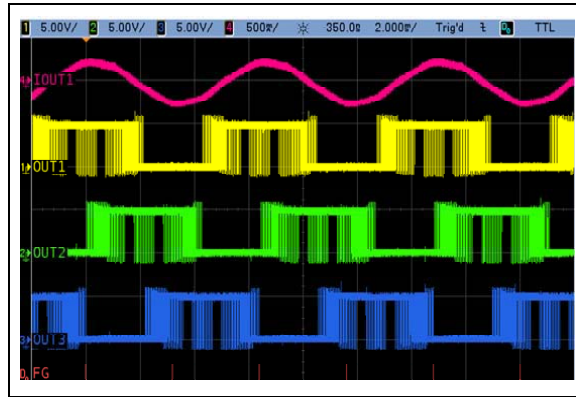

FIGURE 2-12: Typical Outputs on Closed Loop.

3.0 PIN DESCRIPTIONS

The descriptions of the pins are listed in [Table 3-1](#).

TABLE 3-1: MTD6505 PIN FUNCTION TABLE

Pin Number	Type	Name	Function
1	O	FG	Motor Speed Indication Output Pin
2	I	R _{PROG}	K _M Parameter Setting with External Resistors Pin, see Table 4-2 for values
3	—	V _{BIAS}	Internal Regulator Output Pin (for decoupling only)
4	O	OUT1	Single-Phase Coil Output Pin
5	O	OUT2	Single-Phase Coil Output Pin
6	—	GND	Negative Voltage Supply Pin (ground)
7	O	OUT3	Single-Phase Coil Output Pin
8	—	V _{DD}	Positive Voltage Supply Pin for Motor Driver
9	I	DIR	Motor Rotation Direction Pin <ul style="list-style-type: none"> - Forward direction: connect this pin to GND or leave floating - Reverse direction: connect this pin to V_{BIAS}
10	I	PWM	PWM Input Signal Pin for Speed Control
11	—	EP	Exposed Thermal Pad Pin (Connect to the ground plan for better thermal dissipation)

Legend: I = Input; O = Output

MTD6505

NOTES:

4.0 FUNCTIONAL DESCRIPTION

The MTD6505 generates a full-wave signal to drive a 3-phase BLDC motor. High efficiency and low power consumption are achieved due to CMOS transistors and synchronous rectification drive type.

4.1 Speed Control

The rotational speed of the motor can be controlled either through the PWM digital input signal or by acting directly on the power supply (V_{DD}). When the PWM signal is High (or left open), the motor rotates at full speed. When the PWM signal is low, the IC outputs are set to high-impedance and the motor is stopped.

By changing the PWM duty cycle, the speed can be adjusted. Thus, the user has freedom to choose the PWM system frequency within a wide range (from 1 kHz to 100 kHz).

Since the PWM pin has an internal pull-up resistor connected to V_{DD} , it is recommended to drive it between 0V and high Z. The PWM driver must be able to support the pull-up resistor current to drive the pin. See "PWM Internal Pull-Up Resistor" in [Section 1.0, Electrical Characteristics](#).

The output transistor activation always occurs at a fixed rate of 30 kHz, which is outside the range of audible frequencies.

- Note 1:** The PWM frequency has no direct effect on the motor speed and is asynchronous with the activation of the output transistors.
- 2:** The standard output frequency is 30 kHz. A 20 kHz output frequency option is available upon request.

4.2 Motor Rotation Direction

The current-carrying order of the outputs depends on the DIR pin state ("Rotation Direction") and is illustrated in [Table 4-1](#). The DIR pin is not designed for dynamic direction change during operation.

TABLE 4-1: MOTOR ROTATION DIRECTION OPTIONS (DIR PIN)

DIR Pin State	Rotation Direction	Outputs Activation Sequence
Connected to GND or Floating	Forward	OUT1 → OUT2 → OUT3
Connected to V_{BIAS}	Reverse	OUT3 → OUT2 → OUT1

4.3 Frequency Generator Function

The Frequency Generator output (FG) is a "Hall Effect Sensor equivalent" digital output, giving information to an external controller about the speed and phase of the motor. The FG pin is an open-drain output, connecting to a logical voltage level through an external pull-up resistor. When a lock or an out-of-sync situation is detected by the driver, this output is set to high-impedance until the motor is restarted. Leave the pin open when it is not used.

4.4 Lock-Up Protection and Automatic Restart

If the motor is blocked and cannot rotate freely, a lock-up protection circuit detects it and disables the driver by setting its outputs to high-impedance to prevent the motor coil from burnout. After a "waiting time" (T_{WAIT}), the lock-up protection is released and normal operation resumes for a given time (T_{RUN}). If the motor is still blocked, a new period of waiting time is started. T_{WAIT} and T_{RUN} timings are fixed internally, so that no external capacitor is required.

4.5 Overcurrent Protection

The motor peak current is limited by the driver to 750 mA (standard value), thus limiting the maximum power dissipation in the coils.

4.6 Thermal Shutdown

The MTD6505 device has a thermal protection function which detects when the die temperature exceeds $T_J = +170^{\circ}\text{C}$. When this temperature is reached, the circuit enters Thermal Shutdown mode, and outputs OUT1, OUT2 and OUT3 are disabled (high-impedance), avoiding IC destruction and allowing the circuit to cool down. When the junction temperature (T_J) drops below $+145^{\circ}\text{C}$, normal operation resumes.

The thermal detection circuit has $+25^{\circ}\text{C}$ hysteresis.

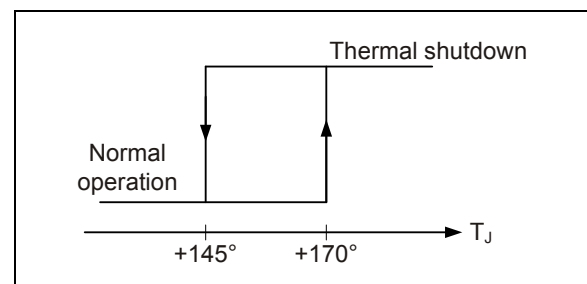

FIGURE 4-1: Thermal Protection Hysteresis.

MTD6505

4.7 Overvoltage Shutdown

The MTD6505 device has an overvoltage protection function which detects when the V_{DD} voltage exceeds $V_{OV} = +7.2V$. When this temperature is reached, the circuit enters Thermal Shutdown mode and outputs OUT1, OUT2 and OUT3 are disabled (high-impedance).

4.8 Internal Voltage Regulator

V_{BIAS} voltage is generated internally and is used to supply internal logical blocks. The V_{BIAS} pin is used to connect an external decoupling capacitor (1 μF or higher). Notice that this pin is for IC internal use, and is not designed to supply DC current to external blocks.

4.9 Back Electromotive Force (BEMF) Coefficient Setting

K_M is the electro-mechanical coupling coefficient of the motor (also referred to as “motor constant” or “BEMF constant”). Depending on the conventions in use, the exact definition of K_M and its measurement criteria can vary among motor manufacturers. To accommodate various motor applications, the MTD6505 provides options to facilitate diverse BEMF coefficients.

The MTD6505 defines BEMF coefficient (K_M) as the peak value of the phase-to-phase BEMF voltage, normalized to the electrical speed of the motor. The following table offers methods to set the K_M value for the MTD6505 device.

TABLE 4-2: K_M SETTINGS

K_M Option	K_M (mV/Hz) Range Phase-to-Phase		R_{PROG}
	Min.	Max.	
K_{M0}	3.25	6.5	GND
K_{M1}	6.5	13	24 k Ω
K_{M2}	13	26	3.9 k Ω
K_{M3}	26	52	V_{BIAS}

The R_{PROG} sensing is actually a sequence that is controlled by the firmware. For any given R_{PROG} , the internal control block will output the corresponding K_M range.

4.10 Defining the Correct R_{PROG} Value

This section explains how to define the correct K_M value for a specific fan. The K_M is linked to the R_{PROG} (see Table 4-2). An incorrect K_M selection can create issues or reduce efficiency.

4.10.1 OPERATION

Follow the next steps to define the right R_{PROG} value:

1. Apply a constant stream of air to a fan that is not connected.
2. Using an oscilloscope, measure the waveform between two phases when the fan is rotating.
3. Measure the generated peak-to-peak voltage (V_{P-P}) value and the frequency (f).
4. Compute K_M based on the measured V_{P-P} and f (in mV/Hz):

EQUATION 4-1: K_M COMPUTE

$$K_M = \frac{V_{P-P}}{2f}$$

K_M should be constant for all fan rotation speeds; but, for the K_M measurement, the fan rotation speed (due to the air stream) should be close to nominal.

Note: This is a theoretical procedure that does not take care of the harmonics generated by the BEMF. This information has to be taken for indication only.

5.0 PACKAGING INFORMATION

5.1 Package Marking Information

10-Lead UDFN (3x3x0.5 mm)



Device	Code
MTD6505T-E/NA	AAAD

Example

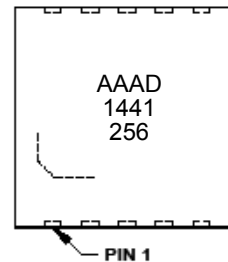

Legend:	XX...X	Customer-specific information
	Y	Year code (last digit of calendar year)
	YY	Year code (last 2 digits of calendar year)
	WW	Week code (week of January 1 is week '01')
	NNN	Alphanumeric traceability code
	(e3)	Pb-free JEDEC® designator for Matte Tin (Sn)
	*	This package is Pb-free. The Pb-free JEDEC designator ((e3)) can be found on the outer packaging for this package.

Note: In the event the full Microchip part number cannot be marked on one line, it will be carried over to the next line, thus limiting the number of available characters for customer-specific information.

MTD6505

10-Lead Ultra-thin Dual Flatpack No-Lead (NA[Y]) – 3x3x0.5 mm Body [UDFN]

Note: For the most current package drawings, please see the Microchip Packaging Specification located at <http://www.microchip.com/packaging>

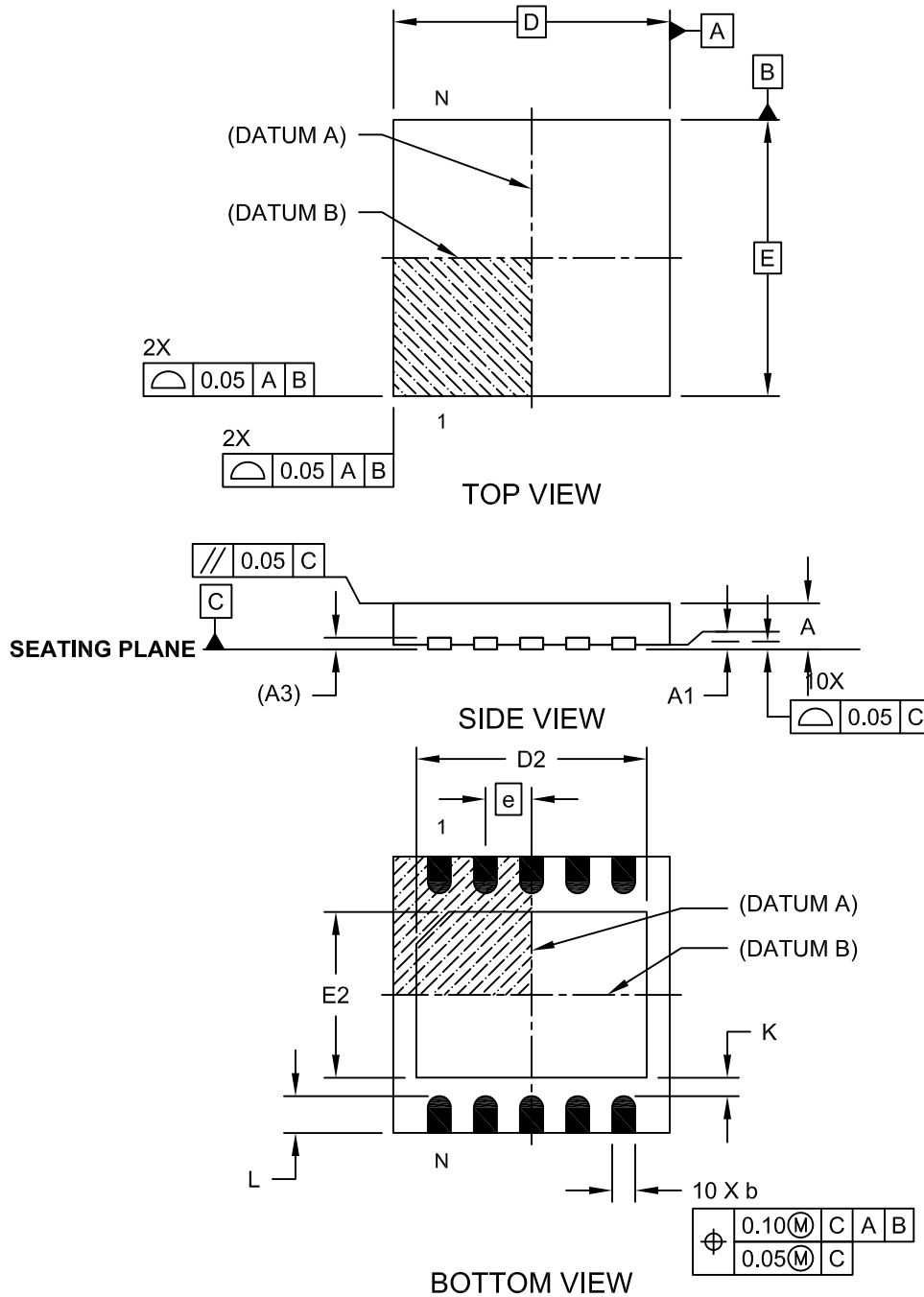

Microchip Technology Drawing C04-194A Sheet 1 of 2

10-Lead Ultra-thin Dual Flatpack No-Lead (NA[Y]) – 3x3x0.5 mm Body [UDFN]

Note: For the most current package drawings, please see the Microchip Packaging Specification located at <http://www.microchip.com/packaging>

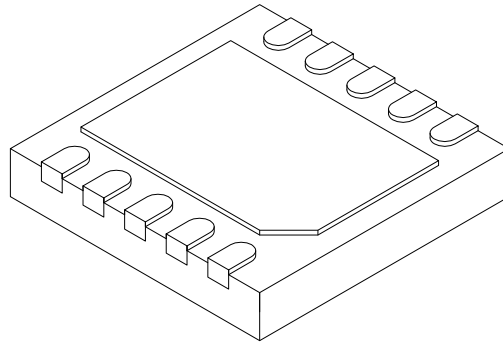

Dimension	Units Limits	MILLIMETERS		
		MIN	NOM	MAX
Number of Pins	N	10		
Pitch	e	0.50 BSC		
Overall Height	A	0.45	0.50	0.55
Standoff	A1	0.00	-	0.05
Overall Length	D	3.00 BSC		
Overall Width	E	3.00 BSC		
Exposed Pad Length	D2	2.40	2.50	2.60
Exposed Pad Width	E2	1.70	1.80	1.90
Terminal Thickness	(A3)	0.127 REF		
Terminal Width	b	0.20	0.25	0.30
Terminal Length	L	0.30	0.40	0.50
Terminal-to-Exposed Pad	K	0.20	-	-

Notes:

- Pin 1 visual index feature may vary, but must be located within the hatched area.
- Package may have one or more exposed tie bars at ends.
- Package is saw singulated
- Dimensioning and tolerancing per ASME Y14.5M.
 BSC: Basic Dimension. Theoretically exact value shown without tolerances.
 REF: Reference Dimension, usually without tolerance, for information purposes only.

Microchip Technology Drawing C04-194A Sheet 2 of 2

MTD6505

10-Lead Ultra-thin Dual Flatpack, No Lead Package (NA[Y]) - 3x3 mm Body (UDFN)

Note: For the most current package drawings, please see the Microchip Packaging Specification located at <http://www.microchip.com/packaging>

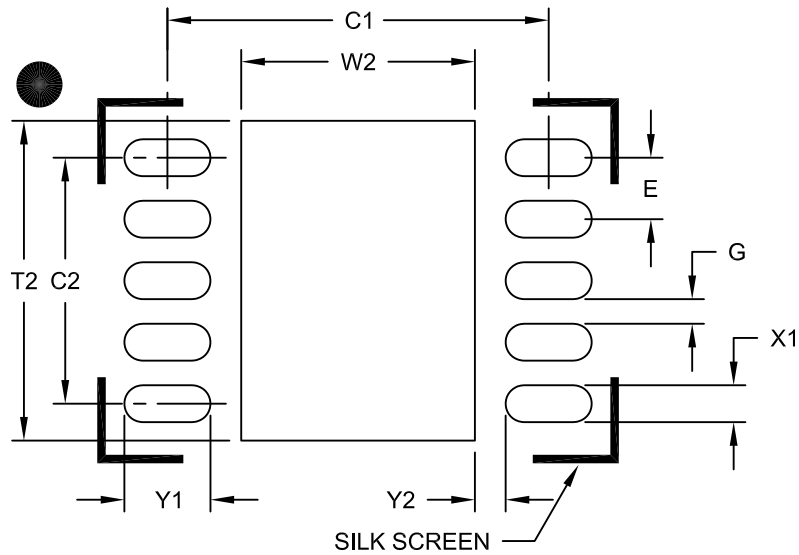

RECOMMENDED LAND PATTERN

Dimension Limits	Units	MILLIMETERS		
		MIN	NOM	MAX
Terminal Pitch	E	0.50 BSC		
Optional Center Pad Width	W2			1.90
Optional Center Pad Length	T2			2.60
Terminal Pad Spacing	C1		3.10	
Terminal Pad Spacing	C2		2.00	
Terminal Pad Width (X10)	X1			0.30
Terminal Pad Length (X10)	Y1			0.70
Terminal Pad to Center (X10)	Y2	0.25		
Distance Between Pads	G	0.20		

Notes:

1. Dimensioning and tolerancing per ASME Y14.5M

BSC: Basic Dimension. Theoretically exact value shown without tolerances.

Microchip Technology Drawing No. C04-2194A

APPENDIX A: REVISION HISTORY

Revision C (December 2014)

The following is the list of modifications:

1. Changed the title of the document.
2. Changed the minimum and maximum values for DIR Input H Level in the [Electrical Characteristics](#) table.
3. Updated [Section 4.0 “Functional Description”](#). Added new [Section 4.7 “Overvoltage Shutdown”](#).
4. Minor editorial corrections.

Revision B (October 2013)

The following is the list of modifications:

1. Updated the [Absolute Maximum Ratings†](#) section with the correct V_{BIAS} parameter.
2. Updated the Thermal Resistance values in the [Temperature Specifications](#) table.
3. Added [Figure 2-11](#) and [Figure 2-12](#).
4. Added [Section 4.10 “Defining the Correct RPROG Value”](#).
5. Minor grammatical and editorial corrections.

Revision A (November 2011)

- This is the original release of this document.

MTD6505

NOTES:

PRODUCT IDENTIFICATION SYSTEM

To order or obtain information, e.g., on pricing or delivery, refer to the factory or the listed sales office.

<u>PART NO.</u>	<u>T</u>	<u>-X</u>	<u>/XX</u>
Device	Tape & Reel	Temperature	Package
Device:	MTD6505T: 3-Phase Sinusoidal Sensorless Brushless Motor Driver (Tape and Reel)		
Temperature Range:	E	=	Extended -40°C to +125°C
Package:	NA	=	Plastic Dual Flat, thermally-enhanced, 3x3x0.5 mm Body (UDFN)

Examples:

a) MTD6505T-E/NA Tape and Reel, Extended Temperature 10-Lead UDFN Package

MTD6505

NOTES:

Note the following details of the code protection feature on Microchip devices:

- Microchip products meet the specification contained in their particular Microchip Data Sheet.
- Microchip believes that its family of products is one of the most secure families of its kind on the market today, when used in the intended manner and under normal conditions.
- There are dishonest and possibly illegal methods used to breach the code protection feature. All of these methods, to our knowledge, require using the Microchip products in a manner outside the operating specifications contained in Microchip's Data Sheets. Most likely, the person doing so is engaged in theft of intellectual property.
- Microchip is willing to work with the customer who is concerned about the integrity of their code.
- Neither Microchip nor any other semiconductor manufacturer can guarantee the security of their code. Code protection does not mean that we are guaranteeing the product as “unbreakable.”

Code protection is constantly evolving. We at Microchip are committed to continuously improving the code protection features of our products. Attempts to break Microchip's code protection feature may be a violation of the Digital Millennium Copyright Act. If such acts allow unauthorized access to your software or other copyrighted work, you may have a right to sue for relief under that Act.

Information contained in this publication regarding device applications and the like is provided only for your convenience and may be superseded by updates. It is your responsibility to ensure that your application meets with your specifications. MICROCHIP MAKES NO REPRESENTATIONS OR WARRANTIES OF ANY KIND WHETHER EXPRESS OR IMPLIED, WRITTEN OR ORAL, STATUTORY OR OTHERWISE, RELATED TO THE INFORMATION, INCLUDING BUT NOT LIMITED TO ITS CONDITION, QUALITY, PERFORMANCE, MERCHANTABILITY OR FITNESS FOR PURPOSE. Microchip disclaims all liability arising from this information and its use. Use of Microchip devices in life support and/or safety applications is entirely at the buyer's risk, and the buyer agrees to defend, indemnify and hold harmless Microchip from any and all damages, claims, suits, or expenses resulting from such use. No licenses are conveyed, implicitly or otherwise, under any Microchip intellectual property rights.

Trademarks

The Microchip name and logo, the Microchip logo, dsPIC, FlashFlex, flexPWR, JukeBlox, KEELOQ, KEELOQ logo, Klear, LANCheck, MediaLB, MOST, MOST logo, MPLAB, OptoLyzer, PIC, PICSTART, PIC³² logo, RightTouch, SpyNIC, SST, SST Logo, SuperFlash and UNI/O are registered trademarks of Microchip Technology Incorporated in the U.S.A. and other countries.

The Embedded Control Solutions Company and mTouch are registered trademarks of Microchip Technology Incorporated in the U.S.A.

Analog-for-the-Digital Age, BodyCom, chipKIT, chipKIT logo, CodeGuard, dsPICDEM, dsPICDEM.net, ECAN, In-Circuit Serial Programming, ICSP, Inter-Chip Connectivity, KlearNet, KlearNet logo, MiWi, MPASM, MPF, MPLAB Certified logo, MPLIB, MPLINK, MultiTRAK, NetDetach, Omniscient Code Generation, PICDEM, PICDEM.net, PICkit, PICtail, RightTouch logo, REAL ICE, SQI, Serial Quad I/O, Total Endurance, TSHARC, USBCheck, VariSense, ViewSpan, WiperLock, Wireless DNA, and ZENA are trademarks of Microchip Technology Incorporated in the U.S.A. and other countries.

SQTP is a service mark of Microchip Technology Incorporated in the U.S.A.

Silicon Storage Technology is a registered trademark of Microchip Technology Inc. in other countries.

GestIC is a registered trademarks of Microchip Technology Germany II GmbH & Co. KG, a subsidiary of Microchip Technology Inc., in other countries.

All other trademarks mentioned herein are property of their respective companies.

© 2011-2014, Microchip Technology Incorporated, Printed in the U.S.A., All Rights Reserved.

ISBN: 978-1-63276-918-3

QUALITY MANAGEMENT SYSTEM
CERTIFIED BY DNV
== ISO/TS 16949 ==

Microchip received ISO/TS-16949:2009 certification for its worldwide headquarters, design and wafer fabrication facilities in Chandler and Tempe, Arizona; Gresham, Oregon and design centers in California and India. The Company's quality system processes and procedures are for its PIC[®] MCUs and dsPIC[®] DSCs, KEELOQ[®] code hopping devices, Serial EEPROMs, microperipherals, nonvolatile memory and analog products. In addition, Microchip's quality system for the design and manufacture of development systems is ISO 9001:2000 certified.



MICROCHIP

Worldwide Sales and Service

AMERICAS

Corporate Office
2355 West Chandler Blvd.
Chandler, AZ 85224-6199
Tel: 480-792-7200
Fax: 480-792-7277
Technical Support:
<http://www.microchip.com/support>
Web Address:
www.microchip.com

Atlanta
Duluth, GA
Tel: 678-957-9614
Fax: 678-957-1455

Austin, TX
Tel: 512-257-3370

Boston
Westborough, MA
Tel: 774-760-0087
Fax: 774-760-0088

Chicago
Itasca, IL
Tel: 630-285-0071
Fax: 630-285-0075

Cleveland
Independence, OH
Tel: 216-447-0464
Fax: 216-447-0643

Dallas
Addison, TX
Tel: 972-818-7423
Fax: 972-818-2924

Detroit
Novi, MI
Tel: 248-848-4000

Houston, TX
Tel: 281-894-5983

Indianapolis
Noblesville, IN
Tel: 317-773-8323
Fax: 317-773-5453

Los Angeles
Mission Viejo, CA
Tel: 949-462-9523
Fax: 949-462-9608

New York, NY
Tel: 631-435-6000

San Jose, CA
Tel: 408-735-9110

Canada - Toronto
Tel: 905-673-0699
Fax: 905-673-6509

ASIA/PACIFIC

Asia Pacific Office
Suites 3707-14, 37th Floor
Tower 6, The Gateway
Harbour City, Kowloon
Hong Kong
Tel: 852-2943-5100
Fax: 852-2401-3431

Australia - Sydney
Tel: 61-2-9868-6733
Fax: 61-2-9868-6755

China - Beijing
Tel: 86-10-8569-7000
Fax: 86-10-8528-2104

China - Chengdu
Tel: 86-28-8665-5511
Fax: 86-28-8665-7889

China - Chongqing
Tel: 86-23-8980-9588
Fax: 86-23-8980-9500

China - Hangzhou
Tel: 86-571-8792-8115
Fax: 86-571-8792-8116

China - Hong Kong SAR
Tel: 852-2943-5100
Fax: 852-2401-3431

China - Nanjing
Tel: 86-25-8473-2460
Fax: 86-25-8473-2470

China - Qingdao
Tel: 86-532-8502-7355
Fax: 86-532-8502-7205

China - Shanghai
Tel: 86-21-5407-5533
Fax: 86-21-5407-5066

China - Shenyang
Tel: 86-24-2334-2829
Fax: 86-24-2334-2393

China - Shenzhen
Tel: 86-755-8864-2200
Fax: 86-755-8203-1760

China - Wuhan
Tel: 86-27-5980-5300
Fax: 86-27-5980-5118

China - Xian
Tel: 86-29-8833-7252
Fax: 86-29-8833-7256

China - Xiamen
Tel: 86-592-2388138
Fax: 86-592-2388130

China - Zhuhai
Tel: 86-756-3210040
Fax: 86-756-3210049

ASIA/PACIFIC

India - Bangalore
Tel: 91-80-3090-4444
Fax: 91-80-3090-4123

India - New Delhi
Tel: 91-11-4160-8631
Fax: 91-11-4160-8632

India - Pune
Tel: 91-20-3019-1500

Japan - Osaka
Tel: 81-6-6152-7160
Fax: 81-6-6152-9310

Japan - Tokyo
Tel: 81-3-6880-3770
Fax: 81-3-6880-3771

Korea - Daegu
Tel: 82-53-744-4301
Fax: 82-53-744-4302

Korea - Seoul
Tel: 82-2-554-7200
Fax: 82-2-558-5932 or
82-2-558-5934

Malaysia - Kuala Lumpur
Tel: 60-3-6201-9857
Fax: 60-3-6201-9859

Malaysia - Penang
Tel: 60-4-227-8870
Fax: 60-4-227-4068

Philippines - Manila
Tel: 63-2-634-9065
Fax: 63-2-634-9069

Singapore
Tel: 65-6334-8870
Fax: 65-6334-8850

Taiwan - Hsin Chu
Tel: 886-3-5778-366
Fax: 886-3-5770-955

Taiwan - Kaohsiung
Tel: 886-7-213-7830

Taiwan - Taipei
Tel: 886-2-2508-8600
Fax: 886-2-2508-0102

Thailand - Bangkok
Tel: 66-2-694-1351
Fax: 66-2-694-1350

EUROPE

Austria - Wels
Tel: 43-7242-2244-39
Fax: 43-7242-2244-393

Denmark - Copenhagen
Tel: 45-4450-2828
Fax: 45-4485-2829

France - Paris
Tel: 33-1-69-53-63-20
Fax: 33-1-69-30-90-79

Germany - Dusseldorf
Tel: 49-2129-3766400

Germany - Munich
Tel: 49-89-627-144-0
Fax: 49-89-627-144-44

Germany - Pforzheim
Tel: 49-7231-424750

Italy - Milan
Tel: 39-0331-742611
Fax: 39-0331-466781

Italy - Venice
Tel: 39-049-7625286

Netherlands - Drunen
Tel: 31-416-690399
Fax: 31-416-690340

Poland - Warsaw
Tel: 48-22-3325737

Spain - Madrid
Tel: 34-91-708-08-90
Fax: 34-91-708-08-91

Sweden - Stockholm
Tel: 46-8-5090-4654

UK - Wokingham
Tel: 44-118-921-5800
Fax: 44-118-921-5820

03/25/14

X-ON Electronics

Largest Supplier of Electrical and Electronic Components

Click to view similar products for [Motor/Motion/Ignition Controllers & Drivers](#) category:

Click to view products by [Microchip](#) manufacturer:

Other Similar products are found below :

[FSB50550TB2](#) [FSBF15CH60BTH](#) [MSVCPM2-63-12](#) [MSVGW45-14-2](#) [MSVGW54-14-3](#) [MSVGW54-14-5](#) [NTE7043](#) [LA6565VR-TLM-E](#)
[LB11650-E](#) [LB1837M-TLM-E](#) [LB1845DAZ-XE](#) [LC898300XA-MH](#) [SS30-TE-L-E](#) [26700](#) [LV8281VR-TLM-H](#) [BA5839FP-E2](#) [IRAM236-1067A](#) [LA6584JA-AH](#) [LB11847L-E](#) [NCV70501DW002R2G](#) [AH293-PL-B](#) [STK672-630CN-E](#) [TND315S-TL-2H](#) [FNA23060](#) [FSB50250AB](#)
[FNA41060](#) [MSVB54](#) [MSVBTC50E](#) [MSVCPM3-54-12](#) [MSVCPM3-63-12](#) [MSVCPM4-63-12](#) [MSVTA120](#) [FSB50550AB](#)
[NCV70501DW002G](#) [LC898301XA-MH](#) [LV8413GP-TE-L-E](#) [MSVGW45-14-3](#) [MSVGW45-14-4](#) [MSVGW45-14-5](#) [MSVGW54-14-4](#)
[STK984-091A-E](#) [SLA7026M](#) [MP6519GQ-Z](#) [LB11651-E](#) [IRSM515-025DA4](#) [LV8127T-TLM-H](#) [NCP81382MNTXG](#) [TDA21801](#)
[LB11851FA-BH](#) [NCV70627DQ001R2G](#)