



**Mixed Signal
PICtail™ Demo Board
User's Guide**

Note the following details of the code protection feature on Microchip devices:

- Microchip products meet the specification contained in their particular Microchip Data Sheet.
- Microchip believes that its family of products is one of the most secure families of its kind on the market today, when used in the intended manner and under normal conditions.
- There are dishonest and possibly illegal methods used to breach the code protection feature. All of these methods, to our knowledge, require using the Microchip products in a manner outside the operating specifications contained in Microchip's Data Sheets. Most likely, the person doing so is engaged in theft of intellectual property.
- Microchip is willing to work with the customer who is concerned about the integrity of their code.
- Neither Microchip nor any other semiconductor manufacturer can guarantee the security of their code. Code protection does not mean that we are guaranteeing the product as "unbreakable."

Code protection is constantly evolving. We at Microchip are committed to continuously improving the code protection features of our products. Attempts to break Microchip's code protection feature may be a violation of the Digital Millennium Copyright Act. If such acts allow unauthorized access to your software or other copyrighted work, you may have a right to sue for relief under that Act.

Information contained in this publication regarding device applications and the like is provided only for your convenience and may be superseded by updates. It is your responsibility to ensure that your application meets with your specifications. MICROCHIP MAKES NO REPRESENTATIONS OR WARRANTIES OF ANY KIND WHETHER EXPRESS OR IMPLIED, WRITTEN OR ORAL, STATUTORY OR OTHERWISE, RELATED TO THE INFORMATION, INCLUDING BUT NOT LIMITED TO ITS CONDITION, QUALITY, PERFORMANCE, MERCHANTABILITY OR FITNESS FOR PURPOSE. Microchip disclaims all liability arising from this information and its use. Use of Microchip's products as critical components in life support systems is not authorized except with express written approval by Microchip. No licenses are conveyed, implicitly or otherwise, under any Microchip intellectual property rights.

Trademarks

The Microchip name and logo, the Microchip logo, Accuron, dsPIC, KEELOQ, microID, MPLAB, PIC, PICmicro, PICSTART, PRO MATE, PowerSmart, rPIC, and SmartShunt are registered trademarks of Microchip Technology Incorporated in the U.S.A. and other countries.

AmpLab, FilterLab, Migratable Memory, MXDEV, MXLAB, PICMASTER, SEEVAL, SmartSensor and The Embedded Control Solutions Company are registered trademarks of Microchip Technology Incorporated in the U.S.A.

Analog-for-the-Digital Age, Application Maestro, dsPICDEM, dsPICDEM.net, dsPICworks, ECAN, ECONOMONITOR, FanSense, FlexROM, fuzzyLAB, In-Circuit Serial Programming, ICSP, ICEPIC, MPASM, MPLIB, MPLINK, MPSIM, PICKit, PICDEM, PICDEM.net, PICLAB, PICtail, PowerCal, PowerInfo, PowerMate, PowerTool, rLAB, rPICDEM, Select Mode, Smart Serial, SmartTel and Total Endurance are trademarks of Microchip Technology Incorporated in the U.S.A. and other countries.

SQTP is a service mark of Microchip Technology Incorporated in the U.S.A.

All other trademarks mentioned herein are property of their respective companies.

© 2004, Microchip Technology Incorporated, Printed in the U.S.A., All Rights Reserved.

 Printed on recycled paper.

QUALITY MANAGEMENT SYSTEM
CERTIFIED BY DNV
== ISO/TS 16949:2002 ==

Microchip received ISO/TS-16949:2002 quality system certification for its worldwide headquarters, design and wafer fabrication facilities in Chandler and Tempe, Arizona and Mountain View, California in October 2003. The Company's quality system processes and procedures are for its PICmicro® 8-bit MCUs, KEELOQ® code hopping devices, Serial EEPROMs, microperipherals, nonvolatile memory and analog products. In addition, Microchip's quality system for the design and manufacture of development systems is ISO 9001:2000 certified.



Mixed Signal PICtail™ Demo Board User's Guide

Table of Contents

Preface	1
Chapter 1. Product Overview	5
1.1 Introduction	5
1.2 Purpose and Utility of the Mixed Signal PICtail™ Demo Board	5
1.3 Contents of the Mixed Signal PICtail™ Demo Board Kit	5
Chapter 2. Installation and Operation	7
2.1 Introduction	7
2.2 Features	7
2.3 Getting Started	7
2.4 Running the demos	13
Appendix A. Schematics and Layouts	17
A.1 Introduction	17
Appendix B. Bill-Of-Materials (BOM)	25
Appendix C. MixedSignal_V100.asm Description	27
Appendix D. DAC_dtmf.asm Source Code	29
Appendix E. MixedSignal_16f767i.lkr Source Code	39
Appendix F. DTMF Scope Captures	41
Appendix G. Scope Probe Noise Captures	43
Appendix H. Sine Wave and Filtered DTMF Scope Captures	45
Appendix I. MPLAB® IDE Screen Capture	47
Worldwide Sales and Service	48

Mixed Signal PICtail™ Demo Board User's Guide

NOTES:



Mixed Signal PICtail™ Demo Board User's Guide

Preface

NOTICE TO CUSTOMERS

All documentation becomes dated, and this manual is no exception. Microchip tools and documentation are constantly evolving to meet customer needs, so some actual dialogs and/or tool descriptions may differ from those in this document. Please refer to our web site (www.microchip.com) to obtain the latest documentation available.

Documents are identified with a "DS" number. This number is located on the bottom of each page, in front of the page number. The numbering convention for the DS number is "DSXXXXA", where "XXXX" is the document number and "A" is the revision level of the document.

For the most up-to-date information on development tools, see the MPLAB® IDE on-line help. Select the Help menu, and then Topics to open a list of available on-line help files.

INTRODUCTION

This chapter contains general information that will be useful to know before using the Mixed Signal PICtail™ Demo Board. Items discussed in this chapter include:

- About This Guide
- Conventions Used in this Guide
- Recommended Reading
- The Microchip Web Site
- Customer Support

Mixed Signal PICtail™ Demo Board User's Guide

ABOUT THIS GUIDE

Document Layout

This document describes how to use the Mixed Signal PICtail™ Demo Board. The manual layout is as follows:

- **Chapter 1. Product Overview** – Important information about the Mixed Signal PICtail™ Demo Board.
- **Chapter 2. Installation and Operation** – Includes instructions on how to get started with this demo board and a detailed description of each function of the demo board.
- **Appendix A. Schematics and Layouts** – Shows the schematic and layout diagrams for the Mixed Signal PICtail™ Demo Board.
- **Appendix B. Bill-Of-Materials (BOM)** – Lists the parts used to build the Mixed Signal PICtail™ Demo Board.
- **Appendix C. MixedSignal_V100.asm Description** – Example “Main” assembly firmware for the PIC16F767-I/SS microcontroller used to demonstrate the various features of the supported analog products.
- **Appendix D. DAC_dtmf.asm Source Code** – Example assembly source firmware used to generate Dual Tone Multiple Frequency (DTMF) signals. This firmware is utilized by the “Main” firmware, `MixedSignal_v100.ASM`.
- **Appendix E. MixedSignal_16f767i.lkr Source Code** – Linker script file used to build the example PIC16F767 firmware.
- **Appendix F. DTMF Scope Captures** – Oscilloscope screen captures of the various DTMF tones displaying their FFT to illustrate the quality of the DTMF tones.
- **Appendix G. Scope Probe Noise Captures** – Isolating scope probe noise is challenging. These scope captures illustrate the difference between using a standard scope probe and using coaxial cable directly from the board into the scope.
- **Appendix H. Sine Wave and Filtered DTMF Scope Captures** – Oscilloscope screen capture of the 32-step sine wave routine and the DTMF waveform. The DTMF waveform illustrates the non-filtered DAC output and a simple RC-filtered output.
- **Appendix I. MPLAB® IDE Screen Capture** – MPLAB IDE 6.3x was used to generate the example source firmware. This screen capture illustrates the tool, the project files and the included Watch windows.

CONVENTIONS USED IN THIS GUIDE

This manual uses the following documentation conventions:

DOCUMENTATION CONVENTIONS

Description	Represents	Examples
Arial font:		
Italic characters	Referenced books	<i>MPLAB[®] IDE User's Guide</i>
	Emphasized text	...is the <i>only</i> compiler...
Initial caps	A window	the Output window
	A dialog	the Settings dialog
	A menu selection	select Enable Programmer
Quotes	A field name in a window or dialog	"Save project before build"
Underlined, italic text with right angle bracket	A menu path	<u><i>File>Save</i></u>
Bold characters	A dialog button	Click OK
	A tab	Click the Power tab
'bnnnn	A binary number where <i>n</i> is a digit	'b00100, 'b10
Text in angle brackets < >	A key on the keyboard	Press <Enter>, <F1>
Courier font:		
Plain Courier	Sample source code	#define START
	Filenames	autoexec.bat
	File paths	c:\mcc18\h
	Keywords	_asm, _endasm, static
	Command-line options	-Opa+, -Opa-
	Bit values	0, 1
Italic Courier	A variable argument	<i>file.o</i> , where <i>file</i> can be any valid filename
0xnnnn	A hexadecimal number where <i>n</i> is a hexadecimal digit	0xFFFF, 0x007A
Square brackets []	Optional arguments	mcc18 [options] <i>file</i> [options]
Curly brackets and pipe character: { }	Choice of mutually exclusive arguments; an OR selection	errorlevel {0 1}
Ellipses...	Replaces repeated text	var_name [, var_name...]
	Represents code supplied by user	void main (void) { ... }

Mixed Signal PICtail™ Demo Board User's Guide

RECOMMENDED READING

This user's guide describes how to use the Mixed Signal PICtail™ Demo Board. Other useful documents are listed below. The following Microchip documents are available and recommended as supplemental reference resources.

MCP4921/22, “12-Bit DAC with SPI™ Interface” Data Sheet (DS21897)

Provides detailed information regarding the MCP492X devices.

TC1320, “8-Bit Digital-to-Analog Converter with Two-Wire Interface” Data Sheet (DS21386)

Provides detailed information regarding the TC1320 device.

TC1321, “10-Bit Digital-to-Analog Converter with Two-Wire Interface” Data Sheet (DS21387)

Provides detailed information regarding the TC1321 device.

MCP3302/3304, “13-Bit Plus Sign Differential Input 2.7V Low-Power A/D Converter with SPI™ Serial Interface” Data Sheet (DS21697)

Provides detailed information regarding the MCP3302 and MCP3304 devices.

MCP3204/3208, “2.7V 12-Bit A/D Converters with SPI™ Serial Interface” Data Sheet (DS21298)

Provides detailed information regarding the MCP3204 and MCP3208 devices.

MCP1525/1541, “2.5V and 4.096V Voltage Reference” Data Sheet (DS21653)

Provides detailed information regarding the MCP1525 and MCP1541 devices.

TC55, “1 μ A Low-Dropout Positive Voltage Regulator” Data Sheet (DS21653)

Provides detailed information regarding the TC55 device.

MCP1700, “Low-Quiescent Current LDO” Data Sheet (DS21826)

Provides detailed information regarding the MCP1700 device.

MCP616/617/618/619, “2.3V to 5.5V Micropower Bi-CMOS Op Amps” Data Sheet (DS21613)

Provides detailed information regarding the MCP616, MCP617, MCP618 and MCP619 devices.

PIC16F737, PIC16F747, PIC16F767, PIC16F777, “PIC16F7X7 Data Sheet” (DS30498)

Provides detailed information regarding the PIC16F737, PIC16F747, PIC16F767 and PIC16F777 devices.

THE MICROCHIP WEB SITE

Microchip provides online support via our web site at www.microchip.com. This web site is used as a means to make files and information easily available to customers. Accessible by using your favorite Internet browser, the web site contains the following information:

- **Product Support** – Data sheets and errata, application notes and sample programs, design resources, user's guides and hardware support documents, latest software releases and archived software
- **General Technical Support** – Frequently Asked Questions (FAQ), technical support requests, online discussion groups and Microchip consultant program member listing
- **Business of Microchip** – Product selector and ordering guides, latest Microchip press releases, listing of seminars and events, listings of Microchip sales offices, distributors and factory representatives

CUSTOMER SUPPORT

Users of Microchip products can receive assistance through several channels:

- Distributor or Representative
- Local Sales Office
- Field Application Engineer (FAE)
- Technical Support
- Development Systems Information Line

Customers should contact their distributor, representative or field application engineer (FAE) for support. Local sales offices are also available to help customers. A listing of sales offices and locations is included in the back of this document.

Technical support is available through the web site at: <http://support.microchip.com>

In addition, there is a Development Systems Information Line which lists the latest versions of Microchip's development systems software products. This line also provides information on how customers can receive currently available upgrade kits.

The Development Systems Information Line numbers are:

1-800-755-2345 – United States and most of Canada

1-480-792-7302 – Other International Locations

Mixed Signal PICtail™ Demo Board User's Guide

NOTES:

Chapter 1. Product Overview

1.1 INTRODUCTION

This chapter provides an overview of the Mixed Signal PICtail™ Demo Board and covers the following topics:

- Purpose and utility of the Mixed Signal PICtail™ Demo Board
- Contents of the Mixed Signal PICtail™ Demo Board Kit

1.2 PURPOSE AND UTILITY OF THE MIXED SIGNAL PICtail™ DEMO BOARD

The Mixed Signal PICtail™ Demo Board allows the system designer to quickly evaluate the suitability of several Microchip analog products for their product's design. Microchip's Digital-to-Analog Converters (DACs), Analog-to-Digital Converters (ADCs), V_{REFS} , Low Dropout Output (LDO) regulators and the PIC16F7X7 devices are supported. Evaluating precision analog products for specific applications can be challenging for practical reasons. First, many products are only available in surface-mount packages. Secondly, analog circuits tend to be affected adversely by system noise. Common breadboarding techniques are not practical for these reasons. The Mixed Signal PICtail™ Demo Board utilizes a 4-layer Printed Circuit Board (PCB), with attention paid to reducing system noise.

The Mixed Signal PICtail™ Demo Board can isolate a specific device's performance to establish baseline performance. The board can be customized quickly for specific system requirements.

1.3 CONTENTS OF THE MIXED SIGNAL PICtail DEMO BOARD KIT

This Mixed Signal PICtail™ Demo Board includes:

- The Mixed Signal PICtail™ Demo Board PCB
- PIC16F767 firmware that demonstrates how to configure and write to the MCP492X, MCP482X and TC132X DAC products
- PIC16F767 firmware demonstrating DTMF generation using a DAC
- PIC16F767 firmware demonstrating sine-wave generation using a DAC
- PIC16F767 firmware to configure and read the MCP330X/320X SAR ADCs
- PIC16F767 firmware that configures and reads the MCP3551 Sigma-Delta ADC
- MCP617 dual op amp (standard 8-pin dual layout) that can be configured as an input signal filter (ADC) or an output signal conditioning stage for the DACs
- Four DIP switches allow simple firmware mode selection
- Two indicator LEDs (red and green) for visual feedback
- PICkit™ 1 Flash Starter Kit's 14-pin header provides an interface to Microchip's 8- and 14-pin PICmicro® microcontroller devices

Mixed Signal PICtail™ Demo Board User's Guide

NOTES:

Chapter 2. Installation and Operation

2.1 INTRODUCTION

The Mixed Signal PICtail™ Demo Board demonstrates several Microchip analog products in a signal chain configuration. The product families demonstrated include DACs, ADCs, V_{REFS} , LDOs and PICmicro® microcontroller devices. Evaluating precision analog products for specific applications can be challenging due to noise sources related to the PCB layout and not the silicon under evaluation. The Mixed Signal PICtail™ Demo Board provides the necessary hardware and firmware to exercise each of these devices in real-world applications. Users can quickly modify the existing hardware and firmware to validate functionality for their specific system needs.

2.2 FEATURES

The Mixed Signal PICtail™ Demo Board has the following features:

- Printed Circuit Board (PCB) is a 4-layer board designed to minimize external noise
- A 28-pin PICmicro (PIC16F767) microcontroller footprint is provided to permit code development. In-Circuit Debugger is supported via the RJ11 connector
- The 14-pin header is designed to seamlessly interface to the PICkit™ 1 Flash Starter Kit
- Firmware demonstrating DTMF generation on the MCP492X/482X DAC is included
- Firmware demonstrating a precision sine-wave generation on the TC132X DAC is included
- Firmware to configure and read the MCP330X/320X SAR ADCs is included
- Two precision voltage references (V_{REFS}) are supported (can compare noise)
- Flexible amplifier circuit layout supports a dual op amp in multiple configurations for either an input signal filter (ADC) or an output signal-conditioning stage for the DACs
- Four DIP switches allow simple firmware mode selection are supported
- Two indicator LEDs (red and green) are supported
- Can be powered by either the PICkit™ 1 Flash Starter Kit or by an external 9V supply

2.3 GETTING STARTED

The Mixed Signal PICtail™ Demo Board is assembled and tested for evaluation and demonstration of the MCP492X, MCP482X, TC132X, MCP3551, MCP3302, MCP3204, MCP1541, MCP1701, PIC16F767 and MCP617 features. Additional product samples with footprints supported by this board are included. A block diagram of the demo board is shown in Figure 2-1. Refer to **Appendix A. “Schematics and Layouts”** and **Appendix B. “Bill-Of-Materials (BOM)”** for more detailed circuit information.

Mixed Signal PICtail™ Demo Board User's Guide

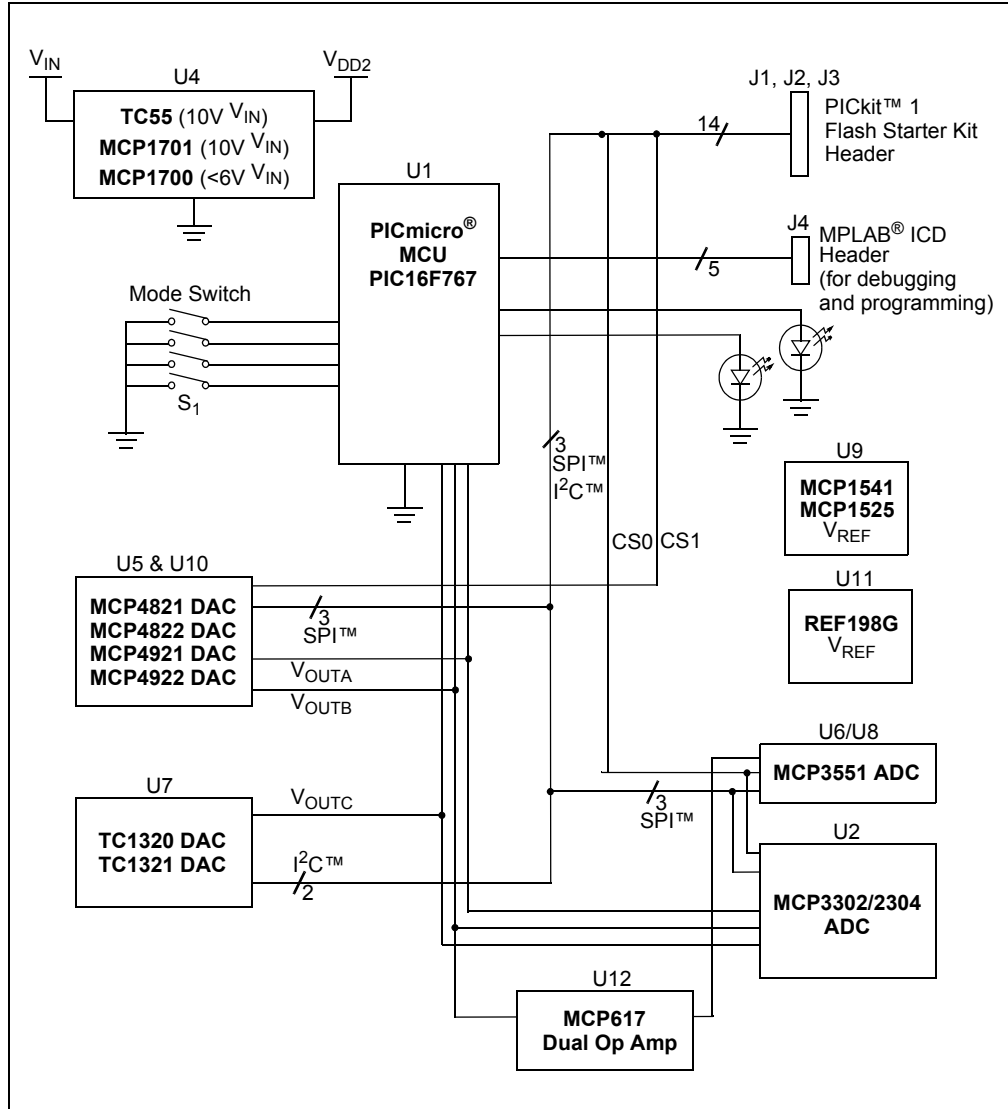

FIGURE 2-1: Mixed Signal PICtail™ Demo Board Block Diagram.

2.3.1 The Hardware

Figure 2-2 shows the layout of the Mixed Signal PICtail™ Demo Board with indicators to points of interest, while Table 2-1 details the PICKIT™ 1 Flash Starter Kit Header connections. Jumpers JP1-JP5 are fully described in Section 2.3.2 “The Embedded System Firmware”.

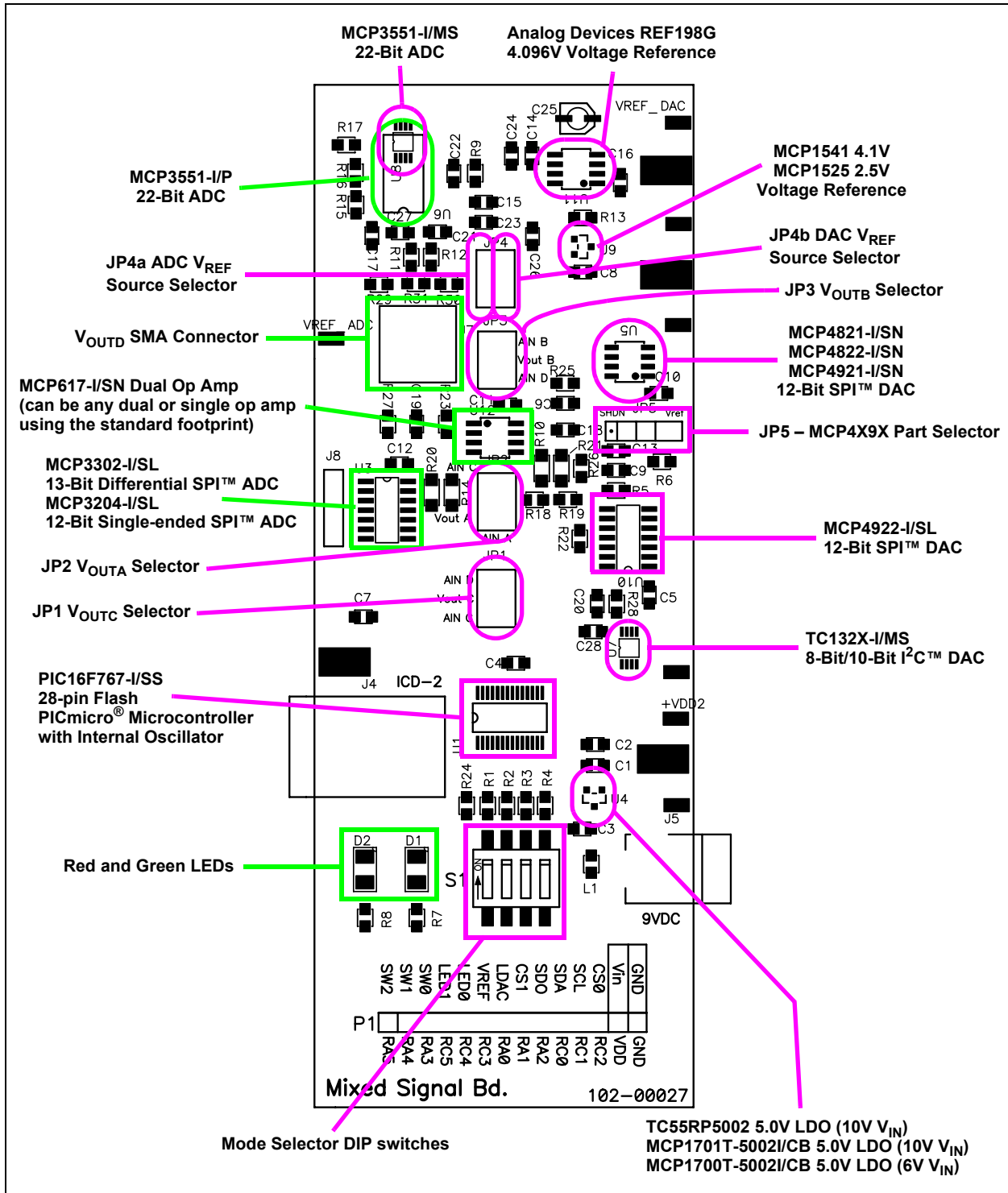

FIGURE 2-2: Mixed Signal PICtail™ Demo Board.

Mixed Signal PICtail™ Demo Board User's Guide

TABLE 2-1: PICKIT™ 1 FLASH STARTER KIT 14-PIN HEADER INTERFACE PINS

Pin Name	Pin Number	Pin Type	Buffer Type	Description
V _{SS}	14	—	—	Electrical Ground. Both analog and digital.
V _{IN}	13	—	—	Power Supply Input. Refer to Note 2 in Appendix A “Schematics and Layouts” . Do not plug in 9V supply and connect to PICKIT™ 1 Flash Starter Kit.
CS0	12	O	—	SPI™ Chip Select signal for the external ADCs. Do not populate both the MCP3551 and the MCP3302 as they share the same CS0 signal.
SCK/SCL	11	O	ST	SPI Clock or I ² C™ Clock Signal. Note that external weak pull-up R ₂₀ connects this signal to V _{DD2} .
SDI/SDA	10	I/O	ST	SPI Data In or I ² C Data signal (Data Out on ADC). Note that external weak pull-up R ₁₄ connects this signal to V _{DD2} .
SDO	9	O	—	SPI Data Out Signal (Data In on DAC and ADC)
CS1	8	O	—	SPI Chip Select Signal for the External DACs. Do not populate both the MCP492X and the MCP482X as they share the same CS0 signal.
LDAC	7	O	—	Latches the DAC Output When Low. Note the weak pull-down resistor R ₅ if the firmware doesn't drive the pin to a desired state.
V _{REF_ADC}	6	I	—	JP4 selects the V _{REF} source to use as the ADC reference signal. The PICmicro® microcontroller on the PICKIT™ 1 Flash Starter Kit may use this for its internal ADC's V _{REF} .
LED0/TX	5	O	—	Active High Red LED Signal. This I/O also has the USART's TX signal multiplexed on it.
LED1/RX	4	I/O	—	Active High Green LED Signal. This I/O also has the USART's RX signal multiplexed on it.
SW0	3	I	—	S1's Switch 1. This pin uses the internal pull-up resistor to determine when the switch is open.
SW1	2	I	—	S1's Switch 2. This pin uses the internal pull-up resistor to determine when the switch is open.
SW2	1	I	—	S1's Switch 3. This pin uses the internal pull-up resistor to determine when the switch is open.

Legend: TTL = TTL compatible input ST = Schmitt Trigger input with CMOS levels
 I = Input O = Output

2.3.2 The Embedded System Firmware

The Mixed Signal PICtail™ Demo Board firmware utilizes PICmicro® microcontroller assembly language, Microchip MPASM™ assembler and MPLINK™ linker to build the HEX machine file. `MixedSignal_v100.asm`, `DAC_dtmf.asm`, `p16F767.inc` and `MCP492X_16f767i.lkr` files are needed in your project to build the `MixedSignalPICtail.hex`.

`MixedSignal_v100.asm` contains the main program and most of the subroutines. After initialization of critical PICmicro microcontroller peripherals (including the internal oscillator to 8 Mhz), the main loop polls the four DIP switches to determine the selected mode of operation. The DIP switches create a 4-bit binary number from 0 to 15. If a change of mode is detected for 100 ms during 500 ms of scanning, a new mode is selected and the LEDs are alternately flashed for two seconds. Most of the modes will time-out and re-scan the DIP switches periodically.

Refer to **Appendix C. “MixedSignal_V100.asm Description”** for the commented source code further describing each mode.

Modes 0XXX primarily utilize the MCP492X DAC modes:

1. **Mode0000:** Use the DTMF generation subroutine (located in `DAC_dtmf.asm`) to dial a phone number stored in memory. Analyze output on V_{OUTB} or V_{OUTD} 's SMA connector. See **Appendix F. “DTMF Scope Captures”** for resulting waveform frequency analysis.
2. **Mode0001:** Send 000h and FFFh commands to generate a 100 Hz R-R output on the MCP492X. Probe V_{OUTA} and V_{OUTB} to see the resulting waveforms.
3. **Mode0010:** Send 400h and BFFh commands to generate a 100 Hz output on the MCP492X. Probe V_{OUTA} and V_{OUTB} to see the resulting waveforms.
4. **Mode0011:** DACA = SHDN, DACB = SHDN, PIC = SLEEP. This mode demonstrates the low-power nature of the DAC, the PICmicro microcontroller, the op amp and the LDO. A power cycle is required after the mode switch is changed to exit this mode.
5. **Mode0100:** DACB and DACA = 800h and Read w/PIC16F767 10b ADC, “broadcast on USART”. This mode is useful for evaluating the PICmicro microcontroller's ADC. A_{IN_B} can be injected with an alternative signal and the result can be analyzed through the 19200 baud async, 9-bit transmission. Microchip's Data View analysis tool, along with the MCP3551 USB evaluation board, provide a “canned” analysis solution.
6. **Mode0101:** DACB = 801h, DACA = 800h and Read w/MCP3302 13b Dif, “broadcast on USART”. This mode is useful for evaluating the MCP3302 or the MCP3204 ADC. A_{IN_B} can be injected with an alternative signal and the result can be analyzed through the 19200 baud async, 9-bit transmission. Microchip's Data View analysis tool, along with the MCP3551 USB evaluation board, provide a “canned” analysis solution.
7. **Mode0110:** DACB and DACA = 800h and Read w/MCP3551, “broadcast on USART”. This mode is useful for evaluating the MCP3551 ADC or the MCP1541 V_{REF} . A_{IN_B} can be injected with an alternative signal and the result can be analyzed through the 19200 baud async, 9-bit transmission. Microchip's Data View analysis tool, along with the MCP3551 USB evaluation board, provide a “canned” analysis solution.
8. **Mode0111:** Open for user to define their own routine.

Mixed Signal PICtail™ Demo Board User's Guide

Modes 1XXX primarily utilize TC132X DAC modes:

1. **Mode1000:** Generate a 100 Hz 32-step sine wave on the TC132X. Analyze output on V_{OUTC} . See **Appendix H. "Sine Wave and Filtered DTMF Scope Captures"** for resulting unfiltered waveform.
2. **Mode1001:** Send 000h and FFFh commands to generate a 100 Hz R-R output on the TC132X. Probe V_{OUTC} to see the resulting waveforms.
3. **Mode1010:** Send 400h and BFFh commands to generate a 100 Hz output on the TC132X. Probe V_{OUTC} to see the resulting waveforms.
4. **Mode1011:** DAC = SHDN, PIC = SLEEP. This mode demonstrates the low-power nature of the DAC, the PICmicro microcontroller, the op amp and the LDO. A power cycle is required after the mode switch is changed to exit this mode.
5. **Mode1100:** DAC = 200h and Read with PIC16F767 10b ADC, "broadcast on USART". A_{IN_C} can be analyzed using Microchip's Data View analysis tool, which, along with the MCP3551 USB evaluation board, provides a "canned" analysis solution.
6. **Mode1101:** DAC = 200h and Read with MCP3302 13b single-ended, "broadcast on USART". A_{IN_C} can be analyzed using Microchip's Data View analysis tool, which, along with the MCP3551 USB evaluation board, provides a "canned" analysis solution.
7. **Mode1110:** Open for user to define their own routine.
8. **Mode1111:** Open for user to define their own routine.

Refer to **Appendix C. "MixedSignal_V100.asm Description"** to view source code and comments.

Refer to **Appendix D. "DAC_dtmf.asm Source Code"** to view source code and comments.

Refer to **Appendix E. "MixedSignal_16f767i.lkr Source Code"** to view the script.

Refer to the `p16f767.inc` standard include file located in your "MPLAB IDE\MCHIP_Tools" folder.

2.4 RUNNING THE DEMOS

The Mixed Signal PICtail™ Demo Board was designed to utilize the PIC16F767 located on the PCB or a PICmicro microcontroller operating on the PICKit™ 1 Flash Starter Kit board. This Mixed Signal PICtail™ Demo Board User's Guide will only discuss the stand-alone operation utilizing the PIC16F767.

2.4.1 Power

The Mixed Signal PICtail™ Demo Board can be powered by either the PICKit™ 1 Flash Starter Kit's V_{DD} and V_{SS} signals or by a DC power supply 9V (5V minimum and 10V maximum). The onboard TC55 5.0V LDO produces a regulated 5.0V supply to operate the analog devices under test. The Mixed Signal PICtail™ Demo Board User's Guide assumes the standard 9V power supply that comes with many of Microchip's development tools (including the MPLAB® ICD 2) is utilized. The standard 9V DC connector is provided for your convenience.

With the default firmware programmed into the PIC16F767, the LED's should alternately flash for approximately two seconds upon power-up.

2.4.2 Selecting the Mode

S_1 is a 4-position DIP switch numerically labeled 1, 2, 3 and 4. These contact switches have one terminal tied to V_{SS} and one terminal connected to a 1 k Ω resistor in series with the PIC16F767 PORTB<4:7> I/O port. These pins have an internal weak pull-up to prevent the I/O from floating when the corresponding DIP switch is open. The DIP switch is labeled with an arrow indicating the "on" (or closed) position of the switch. When the DIP switch is on, the I/O pin is pulled down to V_{SS} . The default firmware will interpret this as a "0". The binary combination of these four DIP switches determine the mode of operation.

Note: Selecting the mode requires the user to not "read" the switches as a binary number. Switch 1 is on the left, while switch 4 is on the right. Typically, the most significant digit is on the left, unlike this configuration. In addition, the "on" position represents a "0", which is also counterintuitive. The user could alter the default firmware to interpret the mode switches differently (change the jump table's order) or simply look at the board with the 14-pin header located at the top.

Refer to **Section 2.3.2 "The Embedded System Firmware"** for operational details for each mode.

2.4.3 Jumper JP1 Selection

Jumper JP1 is located in the center of the board closest to the PICmicro microcontroller and its MPLAB ICD 2 connector. JP1 consists of three pairs of jumper pins. The lower-two pins are connected to A_{IN_C} . The two center pins are connected to V_{OUTC} . The top-two pins are connected to A_{IN_D} .

Refer to Figure 2-2 and **Appendix A. "Schematics and Layouts"**.

If the user would like to read the output of Microchip's TC132X DAC using either the MCP3302 or MCP3204, place a jumper from one of the middle two pins to either of the outer pins, depending on which ADC input channel you are using.

Note: The default firmware Mode1101 requires JP1 to be connected to A_{IN_C} .

Mixed Signal PICtail™ Demo Board User's Guide

2.4.4 Jumper JP2 Selection

Jumper JP2 is located in the center of the board above JP1. JP2 consists of three pairs of jumper pins. The lower two pins are connected to A_{IN_A} . The middle two pins are connected to V_{OUTA} . The top two pins are connected to A_{IN_C} . Refer to Figure 2-2 and **Appendix A. "Schematics and Layouts"**.

If the user would like to read Microchip's MCP492X or MCP482X DAC A output with either the MCP3302 or MCP3204, place a jumper from one of the middle two pins to either of the outer pins, depending on which ADC input channel you are using.

2.4.5 Jumper JP3 Selection

Jumper JP3 is located in the center of the board just above the 8-pin, dual op amp MCP617 and to the right of the SMA connector's footprint. JP3 consists of three pairs of jumper pins. The lower two pins are connected to A_{IN_D} . The middle two pins are connected to V_{OUTB} . The top two pins are connected to A_{IN_B} . Refer to Figure 2-2 and **Appendix A. "Schematics and Layouts"** to view the schematic.

If the user would like to read Microchip's MCP492X or MCP482X DAC B output with either the MCP3302 or MCP3204, place a jumper from one of the middle two pins to either of the outer pins, depending on which ADC input channel you are using.

Note: The default firmware Mode0101 requires JP3 to be connected to A_{IN_B} to read V_{OUTB} with the MCP3302 or MCP3204.

2.4.6 Jumper JP4 Selection

Jumper JP4 is located in the center of the board, farthest away from the PICmicro microcontroller and its MPLAB ICD 2 connector. JP4 consists of three pairs of jumper pins. The lower two pins are connected to the MCP1541's 4.1V V_{REF} output. The top two pins are connected to the REF198G's 4.1V V_{REF} output. The middle two pins are NOT connected, similar to J1, J2 or J3. The middle left pin selects the V_{REF_ADC} source while the middle right pin selects the V_{REF_DAC} source. Refer to Figure 2-2 and **Appendix A. "Schematics and Layouts"**.

If the user employs the REF19G as the V_{REF} source for Microchip's MCP492X or TC132X DACs, a jumper connecting the top right pin with the middle right pin is required. If the user would like to use the MCP1541 as the V_{REF} source for Microchip's MCP492X, MCP482X or TC132X DACs, a jumper connecting the bottom right pin with the middle right pin is required.

Note: The default firmware requires a V_{REF_DAC} jumper to function for almost all modes.

If the user employs the REF19G as the V_{REF} source for Microchip's MCP3302, MCP3204 or PIC16F767 ADCs, a jumper connecting the top right pin with the middle right pin is required. If the user employs the MCP1541 as the V_{REF} source for Microchip's MCP492X, MCP482X or TC132X DACs, a jumper connecting the bottom right pin with the middle right pin is required.

Note: The default firmware Modes0100, 0101, 1100 and 1101 require V_{REF_ADC} to be selected in order to function.

2.4.7 Jumper JP5 Selection

Jumper JP5 is located along the right side of the board, just above the 14-pin MCP492X footprint. JP5 consists of three jumper pins.

JP5 is used to configure the board for the Microchip SPI DAC that gets soldered onto the board. Refer to Figure 2-2 and **Appendix A. “Schematics and Layouts”**.

- If the MCP4922 is used, no jumper is required.
- If the MCP4921 is used, a jumper on the right two pins is required.
- If the MCP4822 is used, no jumper is required.
- If the MCP4821 is used, a jumper on the left two pins is required.

2.4.8 Probe Connections

The most commonly probed signals are available using the surface-mount test points located along the sides of the board. These test points are labeled by the silk-screen. Note that four of these test points are oversized (2x) and are on both sides of the board. This is convenient for connecting probe ground “alligator” clips. These ground connections are critical for minimizing probe noise. The MCP3551 22b ADC is sensitive enough to “see” these noise signals enough to significantly reduce performance. J7 is a SMA connector to allow a fully-shielded connection from the ADC input (V_{OUTD}) to your scope. **Appendix G. “Scope Probe Noise Captures”** illustrates the difference between a normal probe connection and the SMA connection. As you can see, the noise is a product of the scope connection, not the op amp buffer or ADC.

2.4.9 MPLAB ICD 2 Header J4

When using the PIC16F767 (or any other Flash, 28-pin, PICmicro microcontroller with compatible footprint) the MPLAB ICD 2 is a low-cost development tool that can be utilized for code development. The MPLAB ICD 2 has defined a standard connector to simplify In-Circuit Debugging and In-Circuit Serial Programming (ICSP™) of the PICmicro microcontroller.

The MPLAB ICD 2 system is particularly advantageous when developing mixed signal solutions. The MPLAB ICD 2 does not introduce any stray inductance or capacitance typical of emulators’ adapters, cables and interface boards. The PICmicro microcontroller can be soldered onto the board just as it would for standard production. The MPLAB ICD 2 signals remain static during normal operation, therefore adding no noise to the system while executing code.

This RJ11 connector would not be used if the PICKit™ 1 Flash Starter Kit is used for development.

Mixed Signal PICtail™ Demo Board User's Guide

NOTES:



Appendix A. Schematics and Layouts

A.1 INTRODUCTION

This appendix contains the schematics and layouts for the Mixed Signal PICtail™ Demo Board.

Diagrams included in this appendix:

- Board Schematic
- Board - Top + Silk Screen Layer
- Board - Power Layer
- Board - Top Layer
- Board - Bottom Layer
- Board - Ground Layer

FIGURE A-1: BOARD SCHEMATIC - CONTINUED

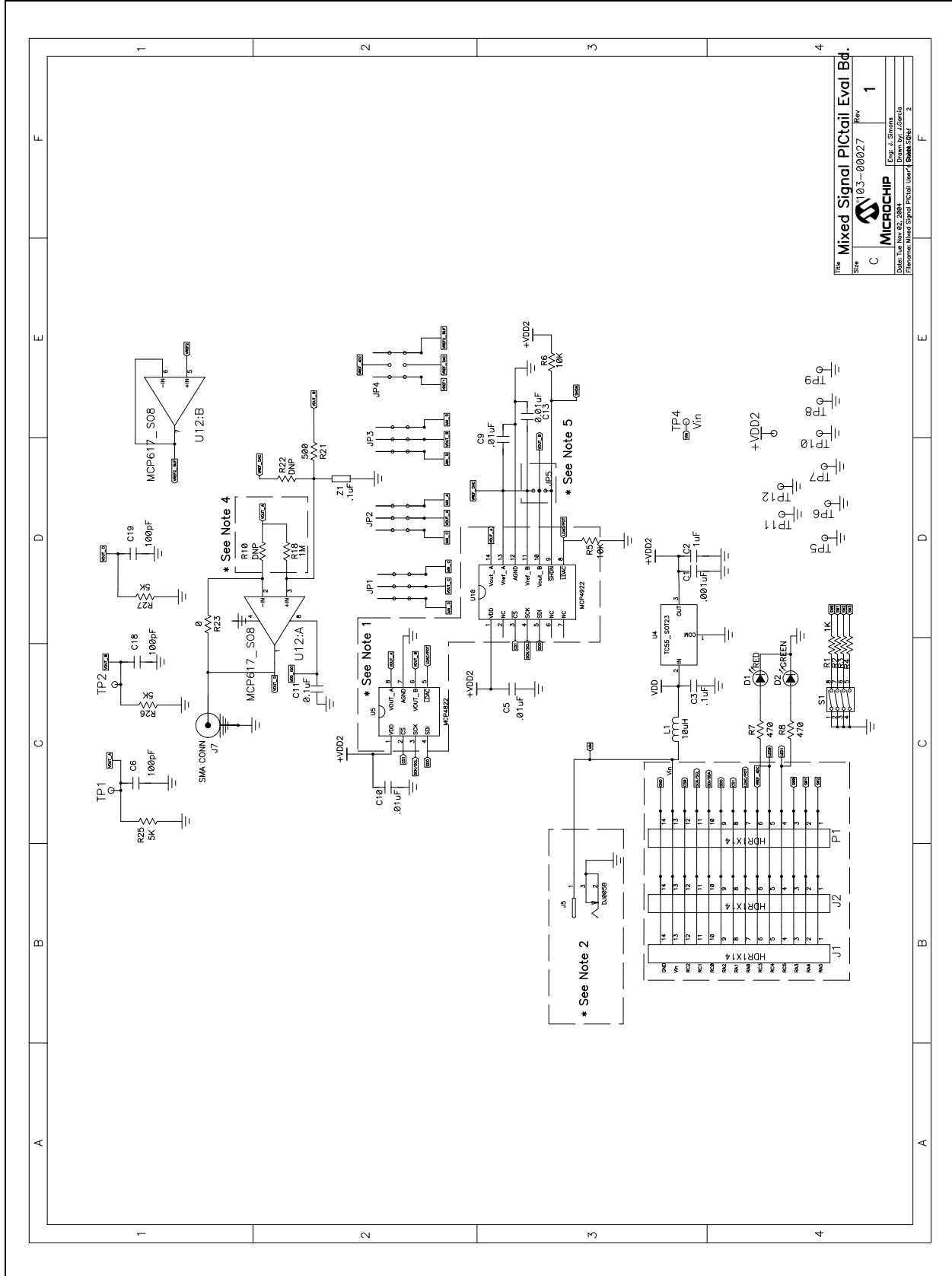

Mixed Signal PICTail™ Demo Board User's Guide

FIGURE A-2: BOARD LAYOUT - TOP + SILK-SCREEN LAYER

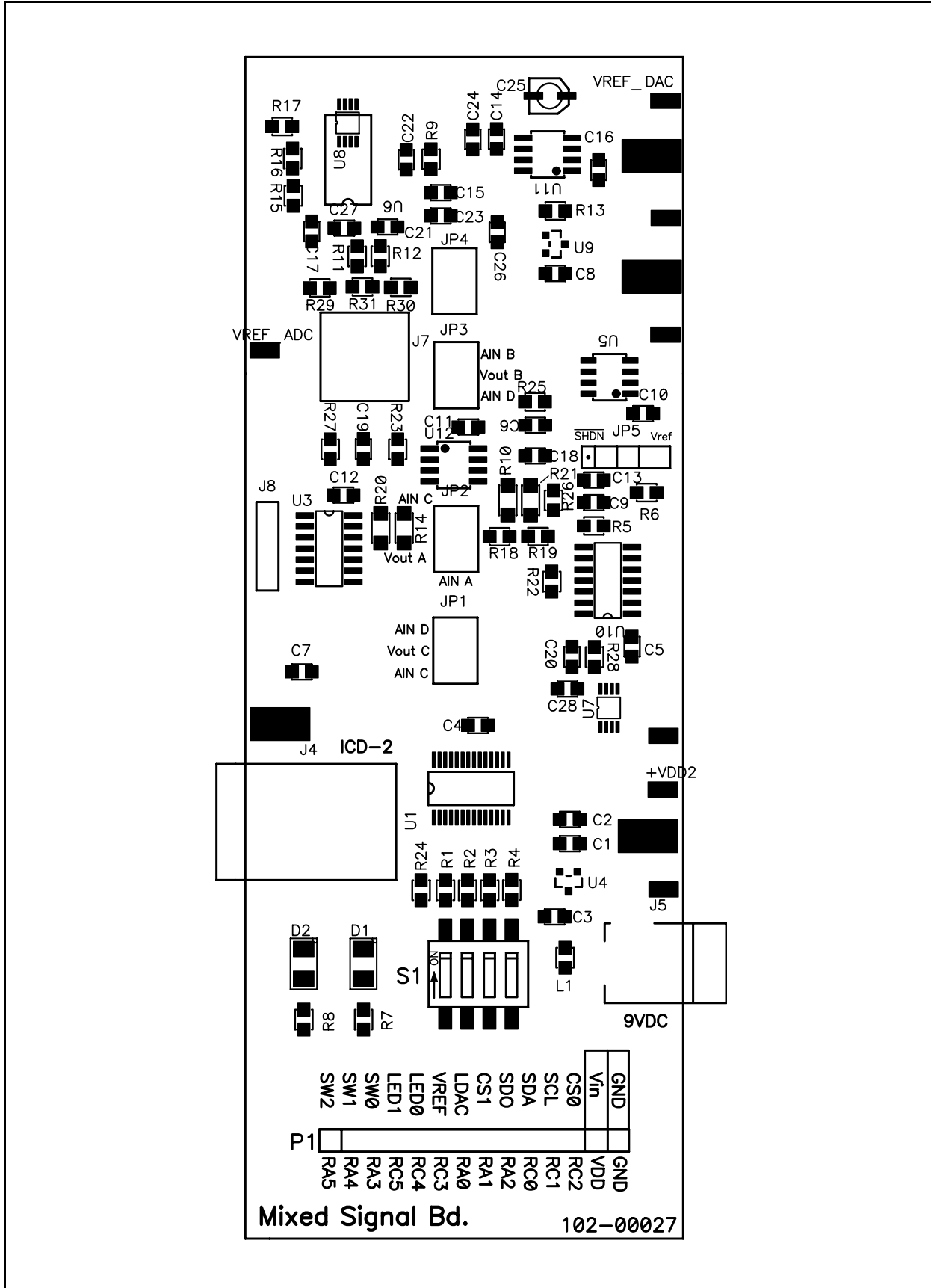
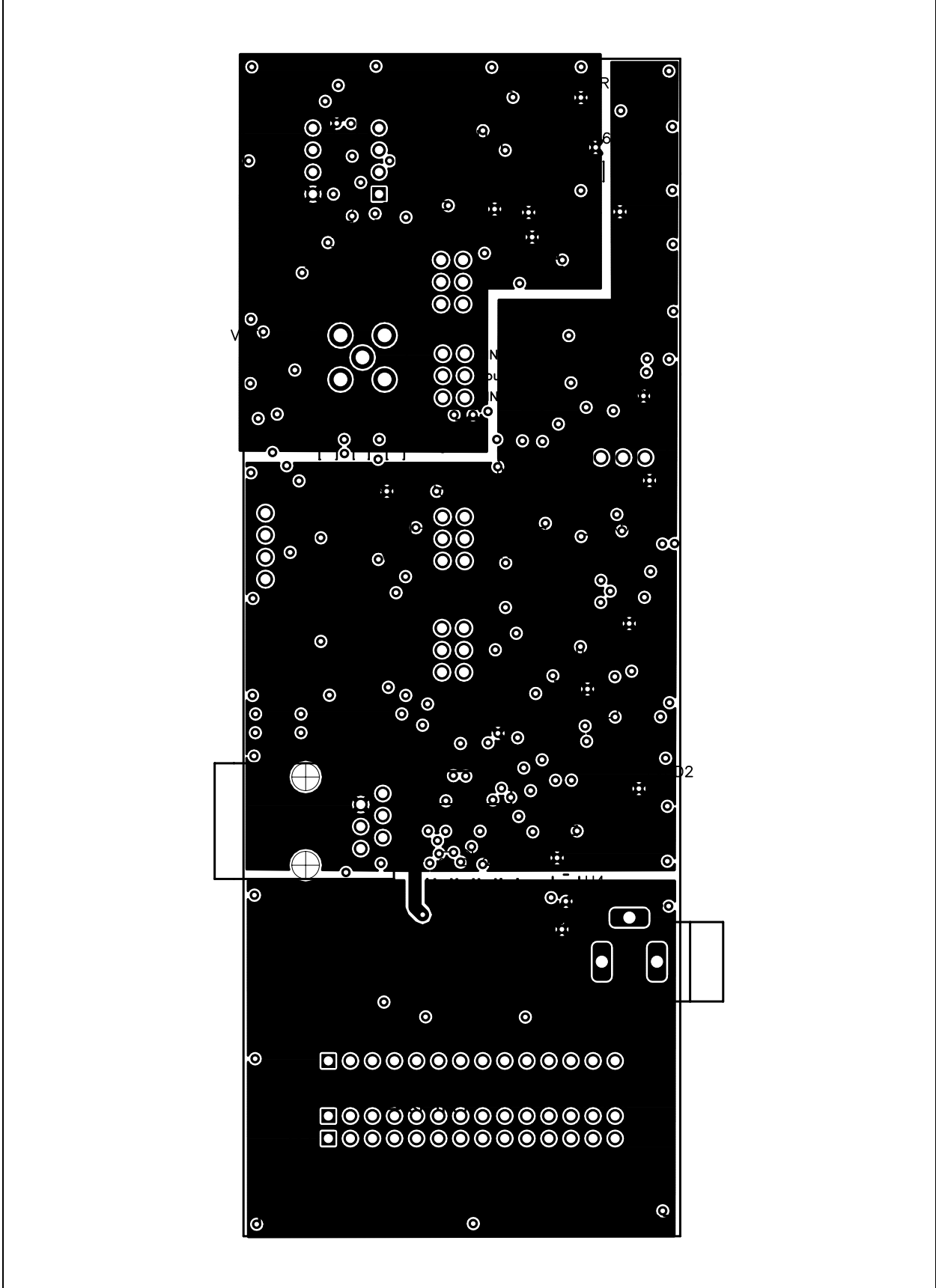

FIGURE A-3: BOARD LAYOUT - POWER LAYER



Mixed Signal PICtail™ Demo Board User's Guide

FIGURE A-4: BOARD LAYOUT - TOP LAYER

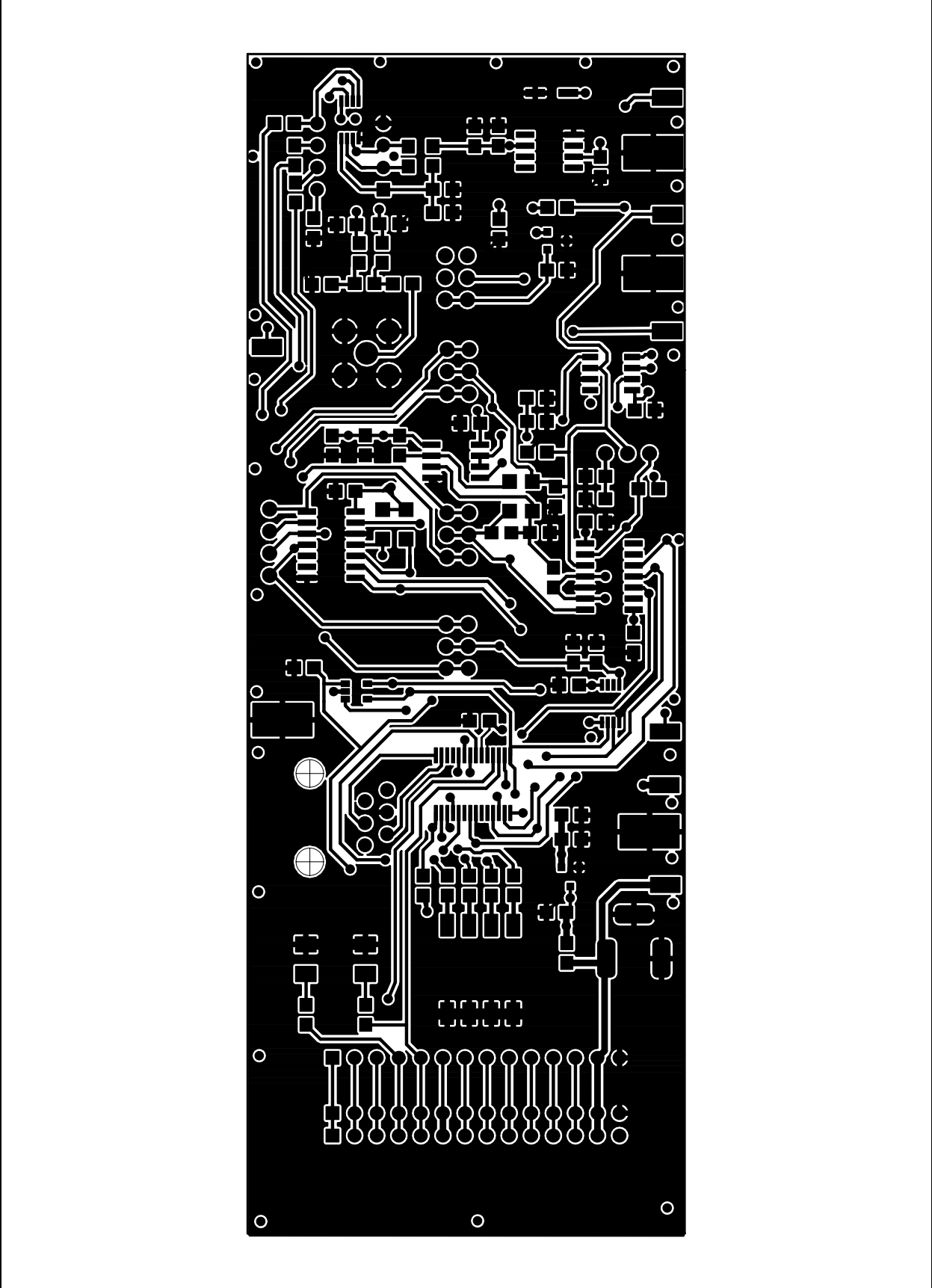
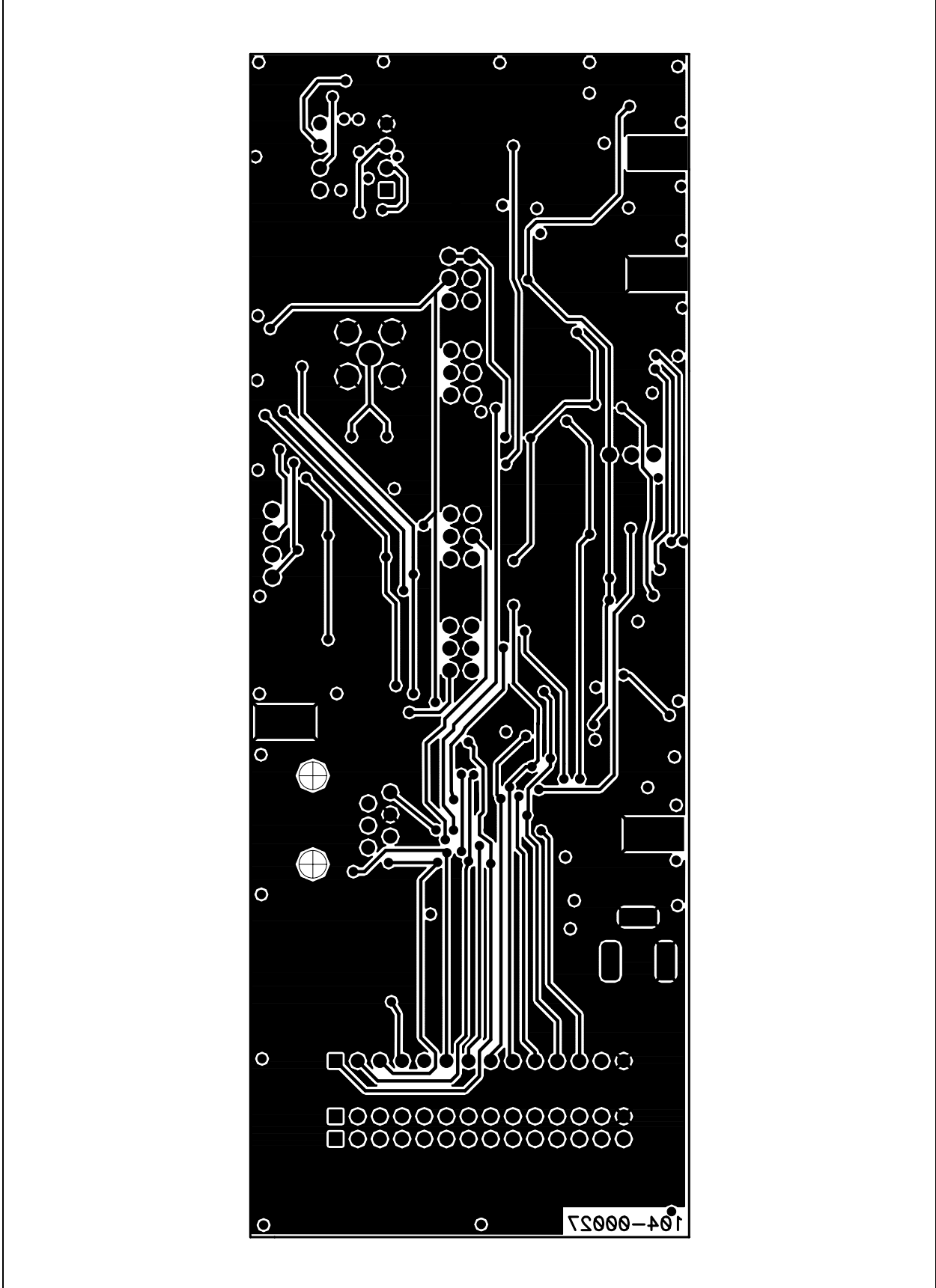
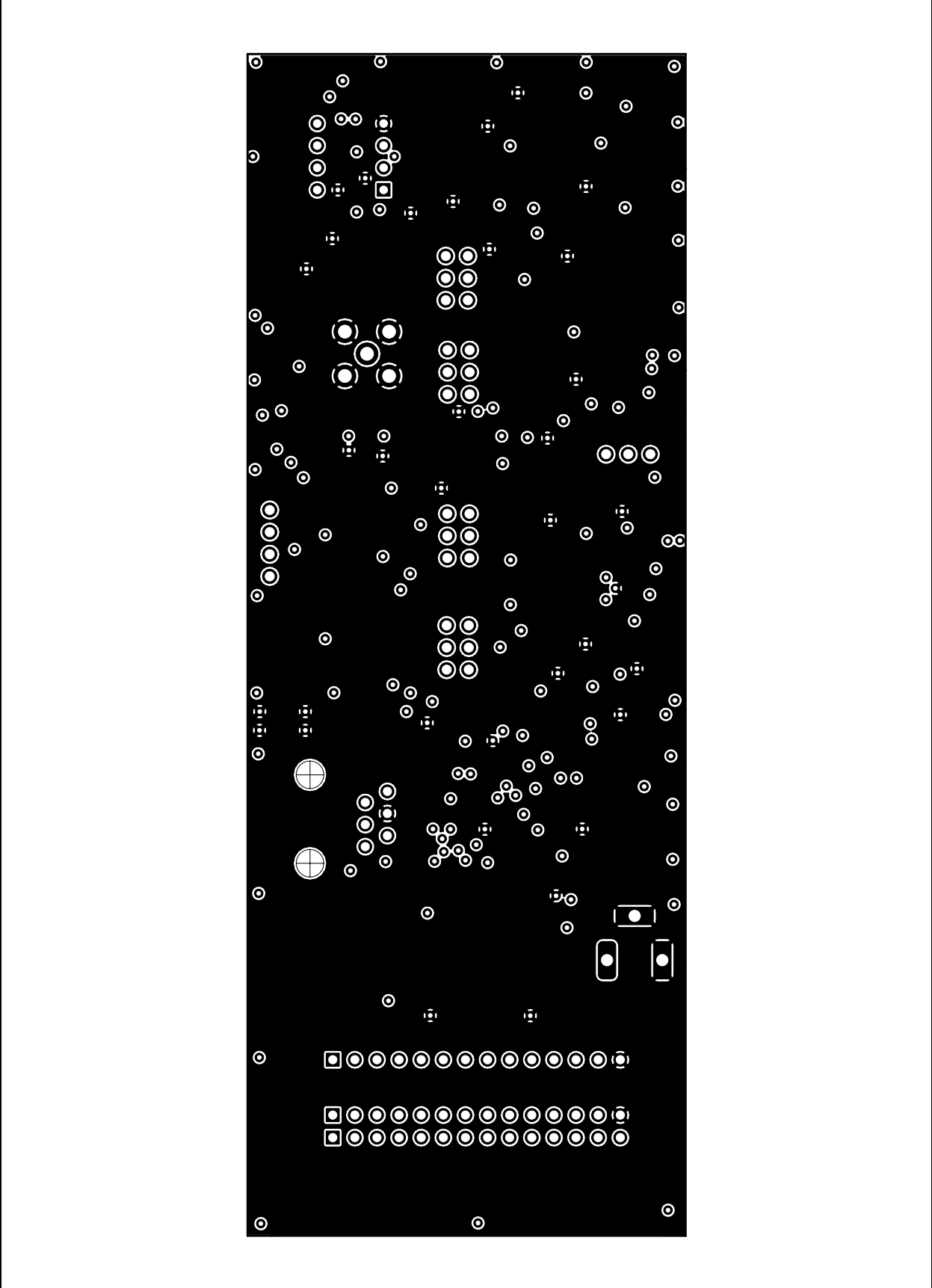

FIGURE A-5: BOARD LAYOUT - BOTTOM LAYER



Mixed Signal PICtail™ Demo Board User's Guide

FIGURE A-6: BOARD LAYOUT - GROUND LAYER



Appendix B. Bill-Of-Materials (BOM)

TABLE B-1: BILL-OF-MATERIALS (BOM)

Qty	Reference	Description	Manufacturer	Part Number
1	C1	Capacitor, Ceramic, 1000 pf 50V, 5%, C0G 0805	Murata Electronics® North America	GRM2165C1H102JA01D
11	C4, C5, C9, C10, C12, C13, C15, C21, C22, C27, C28	Capacitor, 10000 pf, 50V Ceramic, X7R 0805	Kemet®	C0805C103K5RACTU
6	C3, C8, C11, C16, C17, C24	Capacitor, .1 uf, 16V, Ceramic X7R 0805	Panasonic® - ECG	ECJ-2VB1C104K
4	C2, C14, C23, C26	Capacitor, 1 uf, 16V, Ceramic Y5V 0805	Panasonic - ECG	ECJ-2VF1C105Z
4	C6, C18, C19, C20	Capacitor, Ceramic 100 pf, 50V, NP0 0805	Kemet	C0805C101J5GACTU
1	C25	Capacitor, 10 uf, 16V, SMT	Panasonic VS series	ECEV1CS100SR
1	D2	LED, Green, 565 nm, PLCC, 120 deg	Lite-On Trading USA, Inc.	LTST-T670GKT
1	D1	LED, 2.8x3.2 mm, 635 nm, Red, CLR SMD	Lumex® Opto/ Components Inc.	SML-LX2832IC-TR
2	J1, J2	Conn, Header, 14pos, .100 Vert Tin	Molex®/Waldom® Electronics Corp.	22-28-4140
1	J4	Conn, Mod Jack, 6-6 R/A, PCB 50AU	AMP/Tyco Electronics	520470-3
1	J5	Conn, Power Jack, 2.5 mm, PCB CIRC	CUI Inc	PJ-102B
1	J7	Do Not Populate Connectors, RF, Jack, SMA	SPC Technology	SPC10611
4	JP1, JP2, JP3, JP4	Conn, Header, 6pos, .100, Vert Gold	Molex/Waldom Electronics Corp.	10-89-1061
1	JP5	Conn, Header, 3pos, .100, Vert Tin	Molex/Waldom Electronics Corp.	22-28-4030
1	L1	Inductor, Fixed, 10 uh, Type 7BA	Toko America	144LY-100J
1	P1	Conn, Header, 14pos, .100, R/A Tin	Molex/Waldom Electronics Corp.	22-28-8140
3	R23, R29, R30	Resistor, 0.0Ω, 1/8w, 5%, 0805 SMD	Panasonic - ECG	ERJ-6GEY0R00V
6	R1, R2, R3, R4, R11, R12	Resistor, 1.00 kΩ, 1/10w, 1% 0805 SMD	Panasonic - ECG	ERJ-6ENF1001V
2	R18, R22	Resistor, 1.00 mΩ, 1/10w, 1% 0805 SMD	Panasonic - ECG	ERJ-6ENF1004V
4	R25, R26, R27, R28	Resistor, 4.99 kΩ, 1/10w, 1% 0805 SMD	Panasonic - ECG	ERJ-6ENF4991V
2	R10, R31	Do Not Populate		
6	R5, R6, R14, R20, R24	Resistor, 10.0 kΩ, 1/10w, 1% 0805 SMD	Panasonic - ECG	ERJ-6ENF1002V

Mixed Signal PICtail™ Demo Board User's Guide

TABLE B-1: BILL-OF-MATERIALS (BOM) (CONTINUED)

Qty	Reference	Description	Manufacturer	Part Number
5	R9, R13, R15, R16, R17	Resistor, 100Ω, 1/10w, 1% 0805 SMD	Panasonic - ECG	ERJ-6ENF1000V
2	R7, R8	Resistor, 470Ω, 1/8w, 5% 0805 SMD	Panasonic - ECG	ERJ-6GEYJ471V
1	R21	Resistor, 0.0Ω, 1/4w, 5% 1206 SMD	Yageo America	9C12063A0R00JLHFT
1	S1	Switch, Dip 4-pos, Top Slide SMT	CTS Corporation Resistor/Electrocomponents	204-4ST
12	TP1, TP2, TP3, TP4, TP5, TP6, TP7, TP8, TP9, TP10, TP11, TP12	PC, Test Point, Miniature SMT	Keystone Electronics®	5015
1	U1	Microcontroller, 8-bit, CMOS Flash with 10-bit A/D	Microchip Technology Inc.	MCP16F767-I/SS
1	U4	Low Dropout Positive Voltage Regulator	Microchip Technology Inc.	TC55RP5001ECB713
1	U7	10-bit Digital-to-Analog Converter	Microchip Technology Inc.	TC1321EUA
1	U9	Voltage Reference, 4.096V	Microchip Technology Inc.	MCP1541-I/TT
1	U11	IC Volt Ref, LDO, 4.096V, 8-pin SOIC	Analog Devices Inc.	REF198GS



Appendix C. MixedSignal_V100.asm Description

Software License Agreement

The software supplied herewith by Microchip Technology Incorporated (the "Company") is intended and supplied to you, the Company's customer, for use solely and exclusively with products manufactured by the Company.

The software is owned by the Company and/or its supplier, and is protected under applicable copyright laws. All rights are reserved. Any use in violation of the foregoing restrictions may subject the user to criminal sanctions under applicable laws, as well as to civil liability for the breach of the terms and conditions of this license.

THIS SOFTWARE IS PROVIDED IN AN "AS IS" CONDITION. NO WARRANTIES, WHETHER EXPRESS, IMPLIED OR STATUTORY, INCLUDING, BUT NOT LIMITED TO, IMPLIED WARRANTIES OF MERCHANTABILITY AND FITNESS FOR A PARTICULAR PURPOSE APPLY TO THIS SOFTWARE. THE COMPANY SHALL NOT, IN ANY CIRCUMSTANCES, BE LIABLE FOR SPECIAL, INCIDENTAL OR CONSEQUENTIAL DAMAGES, FOR ANY REASON WHATSOEVER.

TABLE C-1: MIXEDSIGNAL_V100.ASM

```
TITLE "Mixed Signal PICtail(TM) Board Firmware"
;*****
; Author:    Jim Simons
; Tools:    MPLAB(R) IDE 6.62 using MPLINK(tm) Linker
; Editor:    ComicSans 8pt w/8 character Tabs
; Files:    MixedSignal_v100.asm
;           DAC_dtmf.asm
;           MixedSignal_16f767i.lkr
;           p16f767inc
;
; Description: Use the DIP Switches to select the mode of operation. The PIC(R) MCU then
; polls for changes in the DIP switches. If a change is detected for 100mS during 500ms of
; scanning, a new mode is selected.
;
; MCP4922 DAC modes
; Mode0000: Flash LEDs and Dial a phone number stored in memory.
; Mode0001: Send 000h & FFFh commands to generate a 100Hz R-R output on the MCP4922.
; Mode0010: Send 400h & BFFh commands to generate a 100Hz output on the MCP4922.
; Mode0011: DACA = SHDN, DACB = SHDN, PIC = SLEEP
; Mode0100: DACB & DACA = 800h & Read w/PIC16F767 10b ADC, "broadcast on USART"
; Mode0101: DACB = 801h, DACA = 800h & Read w/MCP3302 13b Dif, "broadcast on USART"
; Mode0110: DACB & DACA = 800h & Read w/MCP3551, "broadcast on USART"
; Mode0111: Open for user to define their own routine.
; TC132X DAC modes (MUST DEFINE WHICH SPECIFIC DEVICE BELOW)
; Model000: Flash LEDs and generate a 100Hz 32step sine wave on the TC1321.
; Model001: Send 000h & FFFh commands to generate a 100Hz R-R output on the TC1321.
; Model010: Send 400h & BFFh commands to generate a 100Hz output on the TC1321.
; Model011: DAC = SHDN, PIC = SLEEP
; Model100: DAC = 200h & Read w/PIC16F767 10b ADC, "broadcast on USART"
; Model101: DAC = 200h & Read w/MCP3302 13b single-ended, "broadcast on USART"
; Model110: Open for user to define their own routine.
; Model111: Open for user to define their own routine.
;*****
```

Due to file size, only the first page of MixedSignal_V100.asm is shown in Table C-1. Please refer to the Microchip web site at www.microchip.com to download and view the latest version of this firmware.

Mixed Signal PICtail™ Demo Board User's Guide

NOTES:



Appendix D. DAC_dtmf.asm Source Code

Software License Agreement

The software supplied herewith by Microchip Technology Incorporated (the "Company") is intended and supplied to you, the Company's customer, for use solely and exclusively with products manufactured by the Company.

The software is owned by the Company and/or its supplier, and is protected under applicable copyright laws. All rights are reserved. Any use in violation of the foregoing restrictions may subject the user to criminal sanctions under applicable laws, as well as to civil liability for the breach of the terms and conditions of this license.

THIS SOFTWARE IS PROVIDED IN AN "AS IS" CONDITION. NO WARRANTIES, WHETHER EXPRESS, IMPLIED OR STATUTORY, INCLUDING, BUT NOT LIMITED TO, IMPLIED WARRANTIES OF MERCHANTABILITY AND FITNESS FOR A PARTICULAR PURPOSE APPLY TO THIS SOFTWARE. THE COMPANY SHALL NOT, IN ANY CIRCUMSTANCES, BE LIABLE FOR SPECIAL, INCIDENTAL OR CONSEQUENTIAL DAMAGES, FOR ANY REASON WHATSOEVER.

TABLE D-1: DAC_DTMF.ASM

```
#include "p16F767.inc"
;*****
;
; DTMF SUBROUTINE using a Rolling Loop Timer
;
; Program memory = 149 words for 32 step tone subroutine
;                = 133 words for 16 step tone subroutine
; Data memory    = 12 registers for tone subroutine
;
;*****
;
; THEORY OF OPERATION - ROLLING LOOP TIMER
; 2's complement subtraction of a marked time and a continuous timer
; (overflows from 0FFh to 0h) provides an elapsed time which can then
; be compared to some threshold value (another subtraction). The
; result of the compare (<, > or =) can then be used to perform some
; periodic event. The fewest possible cycles per loop is desired to
; achieve the least amount of error from the "zero" cycle (when the
; result of the compare is "="). One major advantages of this
; technique is the ability to use only one timer to keep track of
; several independent periodic events with relatively few instructions
; and instruction cycles.
;
; THEORY OF OPERATION - DISTORTION
; This routine works with relatively low distortion because the
; statistical distribution of the possible error cycles doesn't peak
; at the "zero" cycle but at some repeatable value relative to the
; "zero" cycle. Error cycles will be +-X from the distribution's
; peak instead of from the "zero" cycle.
;
; THEORY OF OPERATION - LOOP TIMING
; LOW - No update yet = 6 cycles
;       - Update output w/o resetting Sine_Table = 18
;       - Update output w/reset of Sine_Table = 19
; HIGH- No update yet = 6 cycles
;       - Update output w/o resetting Sine_Table = 18
;       - Update output w/reset of Sine_Table & ToneLength = 22
;       (Note: end of Tone until Repeat_tone re-enters >11 cycles
;       depending upon user's code)
```

Mixed Signal PICtail™ Demo Board User's Guide

```
; OUTPUT - 5 cycles
;
; THEORY OF OPERATION - CHOOSING # OF STEPS
; Using the above #s:
;   Minimum loop = 17 cycles
;   Maximum loop = 46 cycles
;   Maximum Low distortion = 5 + 22 + 5 = 32
;   Maximum High distortion = 5 + 19 + 5 = 29
;
; These numbers need to be taken into consideration when choosing Fosc
; and the # of steps. Obviously, there is a balance between adding
; more steps (doesn't have to be 2^X # of steps) and the distortion
; caused by not executing the minimum loop very often. The user could
; model this with most mathematical software packages to determine
; what is best for their system.
;
;*****
DTMF          UDATA
F_Low         RES 1 ;# of cycles for the low frequency
F_Low_Rolling RES 1 ;last value of TMR0 when F_Low_Out was updated
F_Low_Step    RES 1 ;SINE table index
F_Low_Out     RES 1 ;Output duty cycle for F_Low
F_High        RES 1 ;# of cycles for the high frequency
F_High_Rolling RES 1 ;last value of TMR0 when F_High_Out was updated
F_High_Step   RES 1 ;SINE table index
F_High_Out    RES 1 ;Output duty cycle for F_High
DTMF_Out      RES 1 ;Output for DAC
ToneLength    RES 1 ;# of F_High cycles used for delay
Key_Value     RES 1 ;what # to dial?

GLOBAL F_Low, F_Low_Rolling, F_Low_Step, F_Low_Out, F_High, F_High_Rolling
GLOBAL F_High_Step, F_High_Out, DTMF_Out, ToneLength, Key_Value
GLOBAL Tone, Repeat_tone
EXTERN DAC_MSB, DAC_LSB, WriteToMCP492X

DTMF_SUB      CODE
;
; Conditional Assembly Control Words
;   ;No = 0, Yes = 1
#define Fosc_8000000 1 ;8MHz oscillator
#define Fosc_4000000 0 ;4MHz oscillator
#define Fosc_3570000 0 ;3.57MHz oscillator

#define ToneLength_150 0 ;150 ms tone per subroutine call
#define ToneLength_100 0 ;100 ms tone per subroutine call
#define ToneLength_50 1 ;50 ms tone per subroutine call

    if Fosc_8000000
#define _32_steps 0 ;32 steps per cycle
#define _16_steps 1 ;16 steps per cycle
    endif
    if Fosc_4000000 | Fosc_3570000
#define _32_steps 0 ;32 steps per cycle
#define _16_steps 1 ;16 steps per cycle
    endif

    if _32_steps
;
;*****
; This is a 32 level lookup table of a 7 bit SINE wave
```

DAC_dtmf.asm Source Code

```
; Y = 7 bit result X = step #
;
; Y = 63 + 64 * Sin (X * 360 / 32)
;
SINE_Table_7bit ;32 step
    addwf PCL,F
    nop ;this location is never used since W != 0
DT .63, .75, .87, .99, .108, .116, .122, .126
DT .127, .126, .122, .116, .108, .99, .87, .75
DT .63, .51, .39, .27, .18, .10, .4, .1
DT .0, .1, .4, .10, .18, .27, .39, .51
    endif

; if _32_steps & _8_bit
;*****
**
; 32 step lookup table of an 8 bit SINE wave
; Y = 8 bit result
; X = step #
; Y = 127 + 128 * Sin (X * 360 / 32)
;
;SINE_Table_32step_8bit
; addwf PCL,F
; nop ;this location is never used since W != 0
; DT .127, .152, .176, .198, .218, .233, .245, .253
; DT .255, .253, .245, .233, .218, .198, .176, .152
; DT .127, .102, .78, .56, .36, .21, .9, .1
; DT .0, .1, .9, .21, .36, .56, .78, .102
; endif

    if _16_steps
;
;*****
; This is a 16 level lookup table of a 7 bit SINE wave
; Y = 7 bit result X = step #
;
; Y = 63 + 64 * Sin (X * 360 / 16)
;
SINE_Table_7bit ;16 step
    addwf PCL,F
    nop ;this location is never used since W != 0
DT .63, .87, .108, .122
DT .127, .122, .108, .87
DT .63, .39, .18, .4
DT .0, .4, .18, .39
    endif

;
;*****
;
; DTMF Frequency Tables
;
; Key Low High
; 0 941 1336
; 1 697 1209
; 2 697 1336
; 3 697 1477
; 4 770 1209
; 5 770 1336
; 6 770 1477
```

Mixed Signal PICtail™ Demo Board User's Guide

```
; 7 852 1209
; 8 852 1336
; 9 852 1477
; A 697 1633
; B 770 1633
; C 852 1633
; D 941 1633
; * 941 1209
; # 941 1477

if ((_32_steps) & (Fosc_8000000)) | ((_16_steps) & (Fosc_4000000))
;
;*****
;
; Delay Calculation for Frequency Generation
; Fosc = 8MHz #steps = 32
; OR
; Fosc = 4MHz #steps = 16
;
; X = Fosc / ( 4 * #steps * Ftone)
;
;
F_Low_table
addwf PCL,F
;X Actual Desired %Error
retlw .66 ;947.0 941 .63%
retlw .90 ;694.4 697 .37%
retlw .90 ;694.4 697 .37%
retlw .90 ;694.4 697 .37%
retlw .81 ;771.6 770 .21%
retlw .81 ;771.6 770 .21%
retlw .81 ;771.6 770 .21%
retlw .73 ;856.2 852 .49%
retlw .73 ;856.2 852 .49%
retlw .73 ;856.2 852 .49%
retlw .90 ;694.4 697 .37%
retlw .81 ;771.6 770 .21%
retlw .73 ;856.2 852 .49%
retlw .66 ;947.0 941 .63%
retlw .66 ;947.0 941 .63%
retlw .66 ;947.0 941 .63%

F_High_table
addwf PCL,F
;X Actual Desired %Error
retlw .47 ;1329.8 1336 .47%
retlw .52 ;1201.9 1209 .59%
retlw .47 ;1329.8 1336 .47%
retlw .42 ;1488.1 1477 .75%
retlw .52 ;1201.9 1209 .59%
retlw .47 ;1329.8 1336 .47%
retlw .42 ;1488.1 1477 .75%
retlw .52 ;1201.9 1209 .59%
retlw .47 ;1329.8 1336 .47%
retlw .42 ;1488.1 1477 .75%
retlw .38 ;1644.7 1633 .72%
retlw .38 ;1644.7 1633 .72%
retlw .38 ;1644.7 1633 .72%
retlw .52 ;1201.9 1209 .59%
```

DAC_dtmf.asm Source Code

```
retlw .42 ;1488.1 1477 .75%
endif

if _16_steps & Fosc_8000000
;
;*****
;
; Delay Calculation for Frequency Generation
; Fosc = 8MHz #steps = 16
;
; X = Fosc / ( 4 * #steps * Ftone)
;
;
F_Low_table
addwf PCL,F
;X Actual Desired %Error
retlw .133 ;939.8 941 .12%
retlw .179 ;698.3 697 .19%
retlw .179 ;698.3 697 .19%
retlw .179 ;698.3 697 .19%
retlw .162 ;771.6 770 .21%
retlw .162 ;771.6 770 .21%
retlw .162 ;771.6 770 .21%
retlw .147 ;850.3 852 .19%
retlw .147 ;850.3 852 .19%
retlw .147 ;850.3 852 .19%
retlw .179 ;698.3 697 .19%
retlw .162 ;771.6 770 .21%
retlw .147 ;850.3 852 .19%
retlw .133 ;939.8 941 .12%
retlw .133 ;939.8 941 .12%
retlw .133 ;939.8 941 .12%

F_High_table
addwf PCL,F
;X Actual Desired %Error
retlw .94 ;1329.8 1336 .47%
retlw .103 ;1213.6 1209 .37%
retlw .94 ;1329.8 1336 .47%
retlw .85 ;1470.6 1477 .43%
retlw .103 ;1213.6 1209 .37%
retlw .94 ;1329.8 1336 .47%
retlw .85 ;1470.6 1477 .43%
retlw .103 ;1213.6 1209 .37%
retlw .94 ;1329.8 1336 .47%
retlw .85 ;1470.6 1477 .43%
retlw .77 ;1623.4 1633 .59% ; may run out of tcy and be too slow
retlw .77 ;1623.4 1633 .59% ; may run out of tcy and be too slow
retlw .77 ;1623.4 1633 .59% ; may run out of tcy and be too slow
retlw .77 ;1623.4 1633 .59% ; may run out of tcy and be too slow
retlw .103 ;1213.6 1209 .37%
retlw .85 ;1470.6 1477 .43%
endif

if _16_steps & Fosc_3570000
;
;*****
;
; Delay Calculation for Frequency Generation
```

Mixed Signal PICtail™ Demo Board User's Guide

```
; Fosc = 3.57MHz      #steps = 16
;
; X = Fosc / ( 4 * #steps * Ftone)
;
F_Low_table
  addwf   PCL,F
  ;X Actual      Desired    %Error
retlw .59 ;945.5    941      .47%
retlw .80 ;697.3    697      .04%
retlw .80 ;697.3    697      .04%
retlw .80 ;697.3    697      .04%
retlw .72 ;774.7    770      .72%
retlw .72 ;774.7    770      .72%
retlw .72 ;774.7    770      .72%
retlw .65 ;858.2    852      .65%
retlw .65 ;858.2    852      .65%
retlw .65 ;858.2    852      .65%
retlw .80 ;697.3    697      .04%
retlw .72 ;774.7    770      .72%
retlw .65 ;858.2    852      .65%
retlw .59 ;945.5    941      .47%
retlw .59 ;945.5    941      .47%
retlw .59 ;945.5    941      .47%

F_High_table
  addwf   PCL,F
  ;X Actual      Desired    %Error
retlw .42 ;1328.1   1336     .59%
retlw .46 ;1212.6   1209     .30%
retlw .42 ;1328.1   1336     .59%
retlw .38 ;1467.9   1477     .61%
retlw .46 ;1212.6   1209     .30%
retlw .42 ;1328.1   1336     .59%
retlw .38 ;1467.9   1477     .61%
retlw .46 ;1212.6   1209     .30%
retlw .42 ;1328.1   1336     .59%
retlw .38 ;1467.9   1477     .61%
retlw .34 ;1640.6   1633     .47%
retlw .34 ;1640.6   1633     .47%
retlw .34 ;1640.6   1633     .47%
retlw .34 ;1640.6   1633     .47%
retlw .46 ;1212.6   1209     .30%
retlw .38 ;1467.9   1477     .61%
endif

;*****
; Tone Length Calculation
; How many high cycles does it take to meet the desired timeout?
;
; ToneLength = desired_length / (1/Freq_high)
;
  if (ToneLength_150)
ToneLength_table
  addwf   PCL,F
  retlw .200
  retlw .181
  retlw .200
  retlw .222
  retlw .181
  retlw .200
```

DAC_dtmf.asm Source Code

```
retlw .222
retlw .181
retlw .200
retlw .222
retlw .245
retlw .245
retlw .245
retlw .245
retlw .181
retlw .222
endif

if ToneLength_100
ToneLength_table
    addwf    PCL,F
    retlw   .134
    retlw   .121
    retlw   .134
    retlw   .148
    retlw   .121
    retlw   .134
    retlw   .148
    retlw   .121
    retlw   .133
    retlw   .148
    retlw   .163
    retlw   .163
    retlw   .163
    retlw   .163
    retlw   .121
    retlw   .148
endif

if ToneLength_50
ToneLength_table
    addwf    PCL,F
    retlw   .67
    retlw   .60
    retlw   .67
    retlw   .74
    retlw   .60
    retlw   .67
    retlw   .74
    retlw   .60
    retlw   .67
    retlw   .74
    retlw   .82
    retlw   .82
    retlw   .82
    retlw   .82
    retlw   .60
    retlw   .74
endif

;*****
Tone      ;The following Syncs the SINE wave and the Timer
          ;Initialize all registers for startup
    movlw  HIGH SINE_Table_7bit
    movwf  PCLATH
    if    _32_steps
```

Mixed Signal PICtail™ Demo Board User's Guide

```
movlw    .32
endif
if    _16_steps
movlw    .16
endif
movwf    F_Low_Step
movwf    F_High_Step
movlw    01Fh
movwf    F_Low_Out
movwf    F_High_Out
movf     TMR0,W
movwf    F_Low_Rolling
movwf    F_High_Rolling
movlw    0Fh
andwf    Key_Value,F
movf     Key_Value,W
call     F_Low_table
movwf    F_Low
movf     Key_Value,W
call     F_High_table
movwf    F_High
Repeat_tone                ;Call here to repeat the tone for ToneLength
                           ;The following inits the ToneLength delay reg's
    movf     Key_Value,W
    call     ToneLength_table
    movwf    ToneLength

test_F_Low                ;Low frequency tone loop timer
    movf     F_Low_Rolling,W
    subwf    TMR0,W        ;result = time since last update
    subwf    F_Low,W      ;Carry bit determines if enough time has elapsed
    btfsc   STATUS,C
    goto     test_F_High   ;do not update the SINE wave yet
    movf     F_Low,W
    addwf    F_Low_Rolling,F ;Very Important to add to the last reference
                           ;instead of using the actual timer value
    decfsz   F_Low_Step,F  ;update the step count
    goto     no_reset_F_Low_Step
    if    _32_steps
    movlw    .32
    endif
    if    _16_steps
    movlw    .16
    endif
    movwf    F_Low_Step
no_reset_F_Low_Step
    movf     F_Low_Step,W
    call     SINE_Table_7bit ;fetch the corresponding Sin value
    movwf    F_Low_Out      ;store result

test_F_High                ;High frequency tone loop timer
    movf     F_High_Rolling,W
    subwf    TMR0,W        ;result = time since last update
    subwf    F_High,W      ;Carry bit determines if enough time has elapsed
    btfsc   STATUS,C
    goto     update_output ;do not update the SINE wave yet
    movf     F_High,W
    addwf    F_High_Rolling,F ;Very Important to add to the last reference
                           ;instead of using the actual timer value
    decfsz   F_High_Step,F ;update the step count
```

DAC_dtmf.asm Source Code

```
goto    no_reset_F_High_Step
if     _32_steps
movlw  .32
endif
if     _16_steps
movlw  .16
endif
movwf  F_High_Step

                                ;ToneLength timer
decfsz ToneLength,F
goto   no_reset_F_High_Step
                                ;ToneLength time expired, Exit subroutine
retlw  00h

no_reset_F_High_Step
movf   F_High_Step,W
call   SINE_Table_7bit ;fetch the corresponding Sin value
movwf  F_High_Out      ;store result

update_output                ;Sum the 2 7-bit SINE outputs & refresh the D/A converter
                                ;We can output one frequency at a time for test purposes
                                ;w/o changing any timing! (Notice the sine wave quality)
movf   F_High_Out,W      ;comment this line for Low frequency Only
; addwf F_High_Out,W      ;uncomment this line for High frequency Only

; movf F_Low_Out,W      ;uncomment this line for Low frequency Only
addwf  F_Low_Out,W      ;comment this line for High frequency Only
movwf  DTMF_Out
xorwf  DAC_LSB,W
btfsc  STATUS,Z        ; nothing changed so continue looping
goto   test_F_Low

; movf DTMF_Out,W      ; Use this if seeking an 8b result
; movwf PORTB          ; Use this if R2R on PortB
; movwf CCP1L          ; Use this if utilizing a HW PWM... shifted R for speed.
swapf  DTMF_Out,W      ; Use this for L shift 8b -> 12b result
movwf  DAC_LSB         ; should mask the 4 LSBs... if we were getting picky
iorlw  b'11110000'    ; Use this for 12b result , set DAC B, Vref Buffered,
                                ; 1x Gain
movwf  DAC_MSB         ; Use this for 12b result, otherwise let it default to
                                ; preload
call   WriteToMCP492X  ; takes 30 Tcy using HW SPI
goto   test_F_Low

tone_done

end
```

Mixed Signal PICtail™ Demo Board User's Guide

NOTES:

Appendix E. MixedSignal_16f767i.lkr Source Code

Software License Agreement

The software supplied herewith by Microchip Technology Incorporated (the "Company") is intended and supplied to you, the Company's customer, for use solely and exclusively with products manufactured by the Company.

The software is owned by the Company and/or its supplier, and is protected under applicable copyright laws. All rights are reserved. Any use in violation of the foregoing restrictions may subject the user to criminal sanctions under applicable laws, as well as to civil liability for the breach of the terms and conditions of this license.

THIS SOFTWARE IS PROVIDED IN AN "AS IS" CONDITION. NO WARRANTIES, WHETHER EXPRESS, IMPLIED OR STATUTORY, INCLUDING, BUT NOT LIMITED TO, IMPLIED WARRANTIES OF MERCHANTABILITY AND FITNESS FOR A PARTICULAR PURPOSE APPLY TO THIS SOFTWARE. THE COMPANY SHALL NOT, IN ANY CIRCUMSTANCES, BE LIABLE FOR SPECIAL, INCIDENTAL OR CONSEQUENTIAL DAMAGES, FOR ANY REASON WHATSOEVER.

TABLE E-1: MIXEDSIGNAL_16F767I.LKR

```
// Sample ICD2 linker command file for 16F767
LIBPATH .
```

```
CODEPAGE  NAME=vectors      START=0x0      END=0x3      PROTECTED
CODEPAGE  NAME=interrupt    START=0x4      END=0x0FF
CODEPAGE  NAME=page0_1     START=0x100    END=0x1FF
CODEPAGE  NAME=page0_2a    START=0x200    END=0x22F
CODEPAGE  NAME=page0_2b    START=0x230    END=0x2FF
CODEPAGE  NAME=page0_3     START=0x300    END=0x3FF
CODEPAGE  NAME=page0_4     START=0x400    END=0x4FF
CODEPAGE  NAME=page0_5     START=0x500    END=0x5FF
CODEPAGE  NAME=page0_6_7   START=0x600    END=0x7FF
CODEPAGE  NAME=page1       START=0x800    END=0xFF
CODEPAGE  NAME=page2       START=0x1000   END=0x17FF
CODEPAGE  NAME=page3       START=0x1800   END=0x1EFF
CODEPAGE  NAME=debug       START=0x1F00   END=0x1FFF   PROTECTED
CODEPAGE  NAME=.idlocs     START=0x2000   END=0x2003   PROTECTED
CODEPAGE  NAME=.test_vect  START=0x2004   END=0x2005   PROTECTED
CODEPAGE  NAME=.device_id  START=0x2006   END=0x2006   PROTECTED
CODEPAGE  NAME=.config     START=0x2007   END=0x2009   PROTECTED
CODEPAGE  NAME=.test       START=0x200A   END=0x203F   PROTECTED

DATABANK  NAME=sfr0          START=0x0      END=0x1F     PROTECTED
DATABANK  NAME=sfr1          START=0x80     END=0x9F     PROTECTED
DATABANK  NAME=sfr2          START=0x100    END=0x10F    PROTECTED
DATABANK  NAME=sfr3          START=0x180    END=0x18F    PROTECTED

DATABANK  NAME=gpr0          START=0x20     END=0x5F
DATABANK  NAME=DTMF         START=0x60     END=0x6F
DATABANK  NAME=gpr1          START=0xA0     END=0xEF
DATABANK  NAME=gpr2          START=0x110    END=0x164
DATABANK  NAME=dbgspr2      START=0x165    END=0x16F    PROTECTED
DATABANK  NAME=gpr3          START=0x190    END=0x1EF

SHAREBANK NAME=dbgspr        START=0x70     END=0x70     PROTECTED
SHAREBANK NAME=dbgspr        START=0xF0     END=0xF0     PROTECTED
SHAREBANK NAME=dbgspr        START=0x170    END=0x170    PROTECTED
SHAREBANK NAME=dbgspr        START=0x1F0    END=0x1F0    PROTECTED
```

Mixed Signal PICtail™ Demo Board User's Guide

```
SHAREBANK  NAME=gprs      START=0x71    END=0x7F
SHAREBANK  NAME=gprs      START=0xF1    END=0xFF
SHAREBANK  NAME=gprs      START=0x171   END=0x17F
SHAREBANK  NAME=gprs      START=0x1F1   END=0x1FF
```

```
SECTION    NAME=RESET      ROM=vectors   // Reset vectors
SECTION    NAME=INTERRUPT  ROM=interrupt // ROM code space -interrupt
SECTION    NAME=MAIN      ROM=page0_1   // ROM code space
SECTION    NAME=MODE0000  ROM=page0_2a  // ROM code space
SECTION    NAME=DTMF_SUB   ROM=page0_2b  // ROM code space
SECTION    NAME=MODE0001  ROM=page0_3   // ROM code space
SECTION    NAME=MODE1000  ROM=page0_4   // ROM code space
SECTION    NAME=OPEN      ROM=page0_5   // ROM code space
SECTION    NAME=SUBROUTINES ROM=page0_6_7 // ROM code space
SECTION    NAME=PROG1     ROM=page1     // ROM code space
SECTION    NAME=PROG2     ROM=page2     // ROM code space
SECTION    NAME=PROG3     ROM=page3     // ROM code space
SECTION    NAME=IDLOCS    ROM=.idlocs   // ID locations
SECTION    NAME=TEST_VECT ROM=.test_vect // Test vector
SECTION    NAME=DEVICEID  ROM=.device_id // Device ID
SECTION    NAME=CONFIG    ROM=.config   // Configuration bits location
SECTION    NAME=TEST      ROM=.test     // Test
```

Appendix F. DTMF Scope Captures

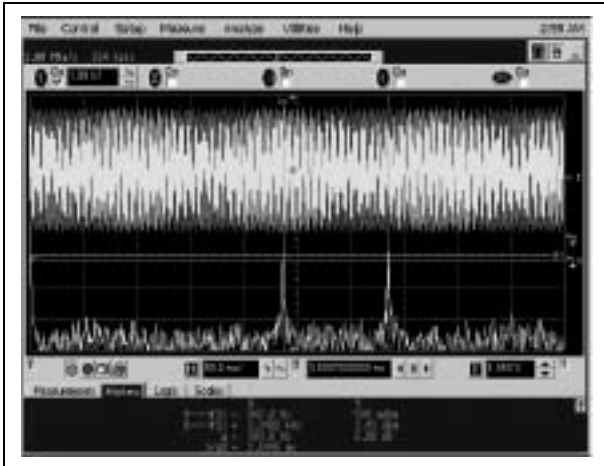

FIGURE F-1: DTMF Tone 0
(941 Hz, 1336 Hz).

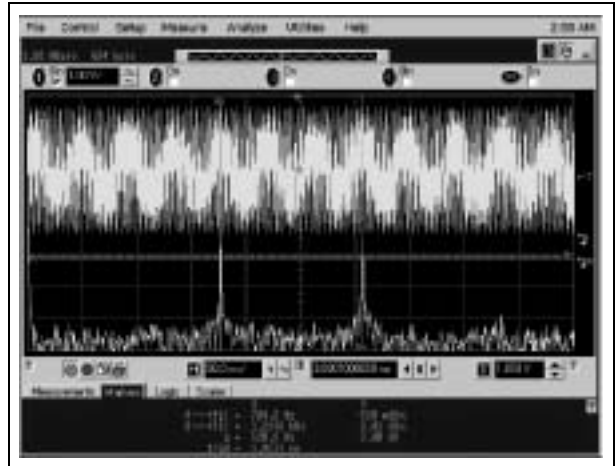

FIGURE F-2: DTMF Tone 1
(697 Hz, 1209 Hz).

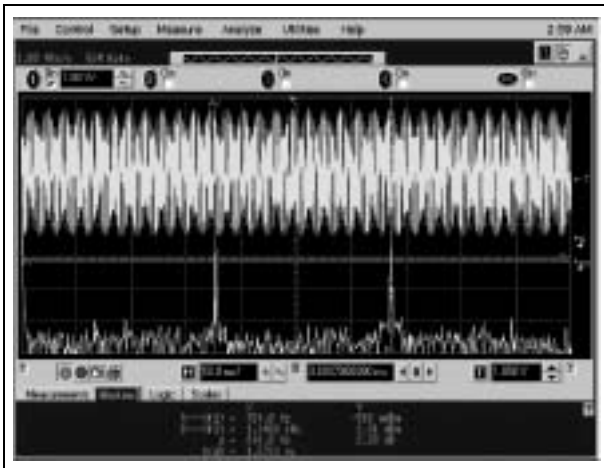

FIGURE F-3: DTMF Tone 2
(697 Hz, 1336 Hz).

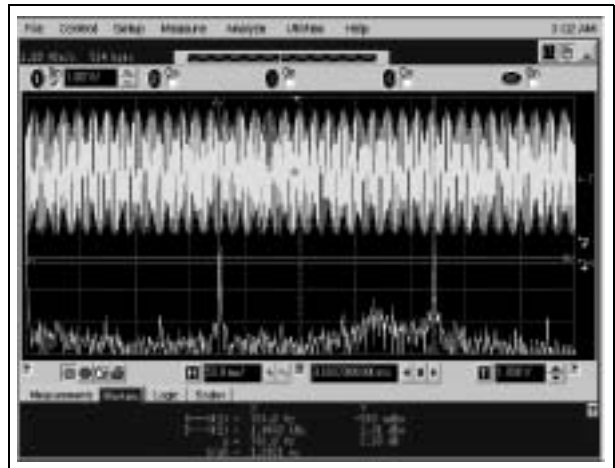

FIGURE F-4: DTMF Tone 3
(697 Hz, 1477 Hz).

Mixed Signal PICtail™ Demo Board User's Guide

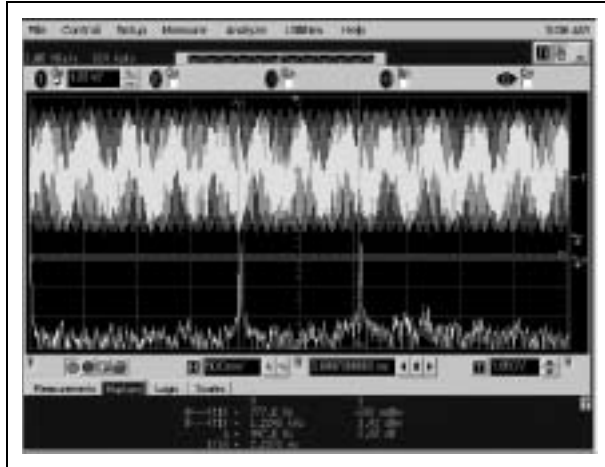

FIGURE F-5: DTMF Tone 4
(770 Hz, 1209 Hz).



FIGURE F-6: DTMF Tone 5
(770 Hz, 1336 Hz).

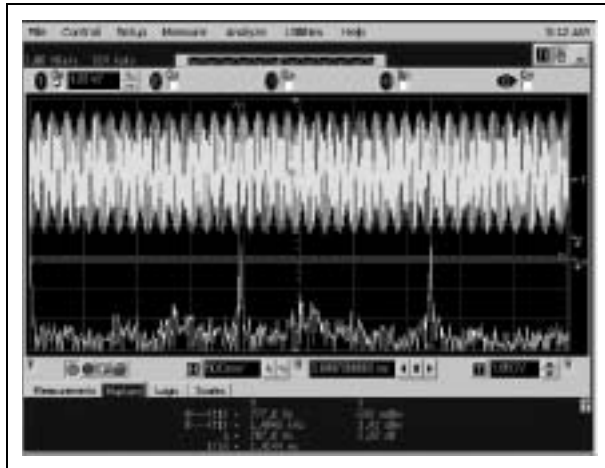

FIGURE F-7: DTMF Tone 6
(770 Hz, 1477 Hz).

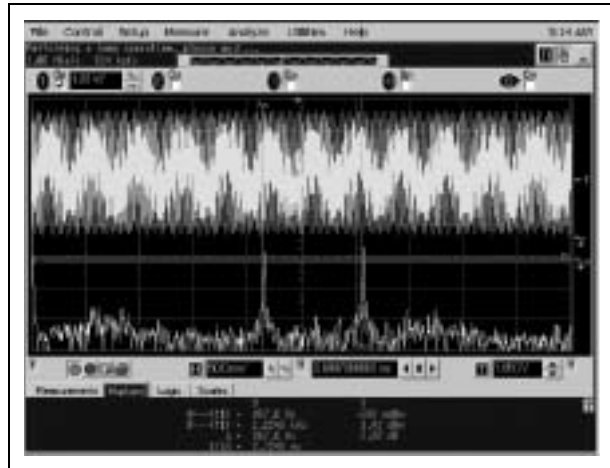

FIGURE F-8: DTMF Tone 7
(852 Hz, 1209 Hz).

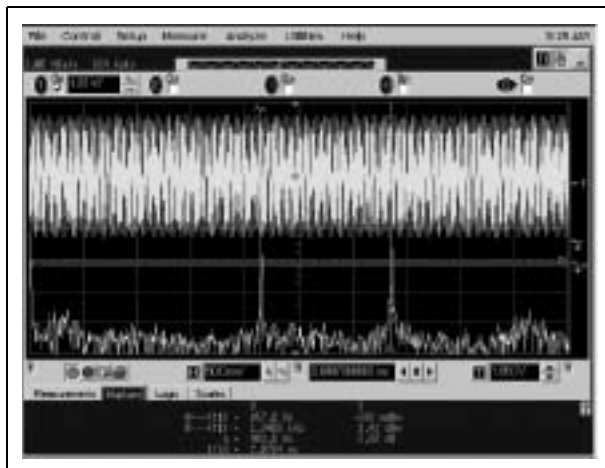

FIGURE F-9: DTMF Tone 8
(852 Hz, 1336 Hz).

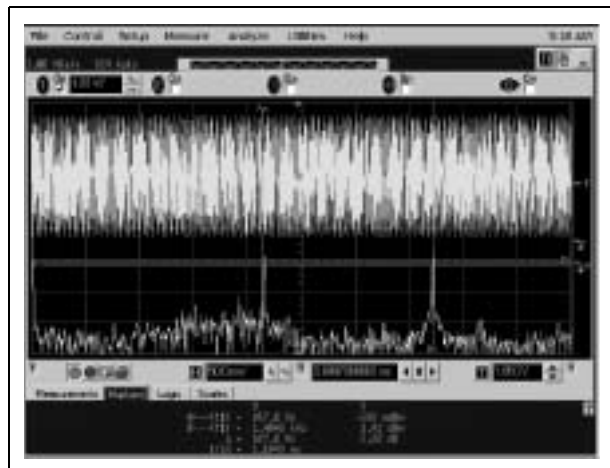

FIGURE F-10: DTMF Tone 9
(852 Hz, 1477 Hz).

Appendix G. Scope Probe Noise Captures

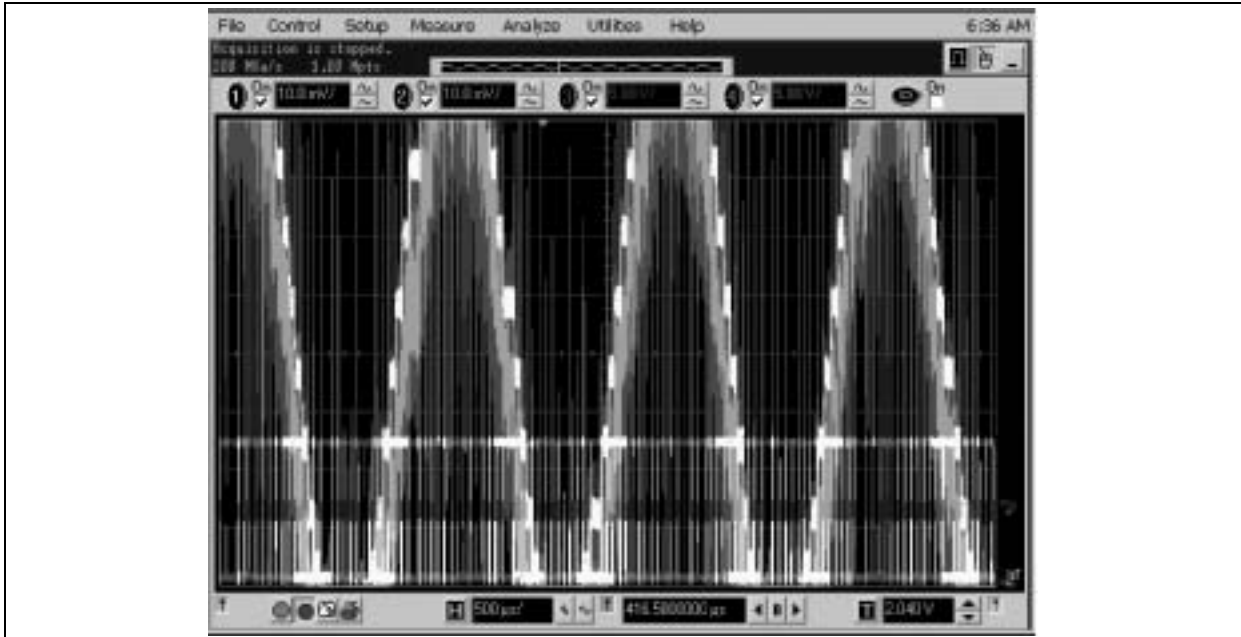

FIGURE G-1: Oscilloscope screen capture of V_{OUT_B} using a standard scope probe and short ground lead. This illustrates the noise picked up by the scope probe and ground lead.

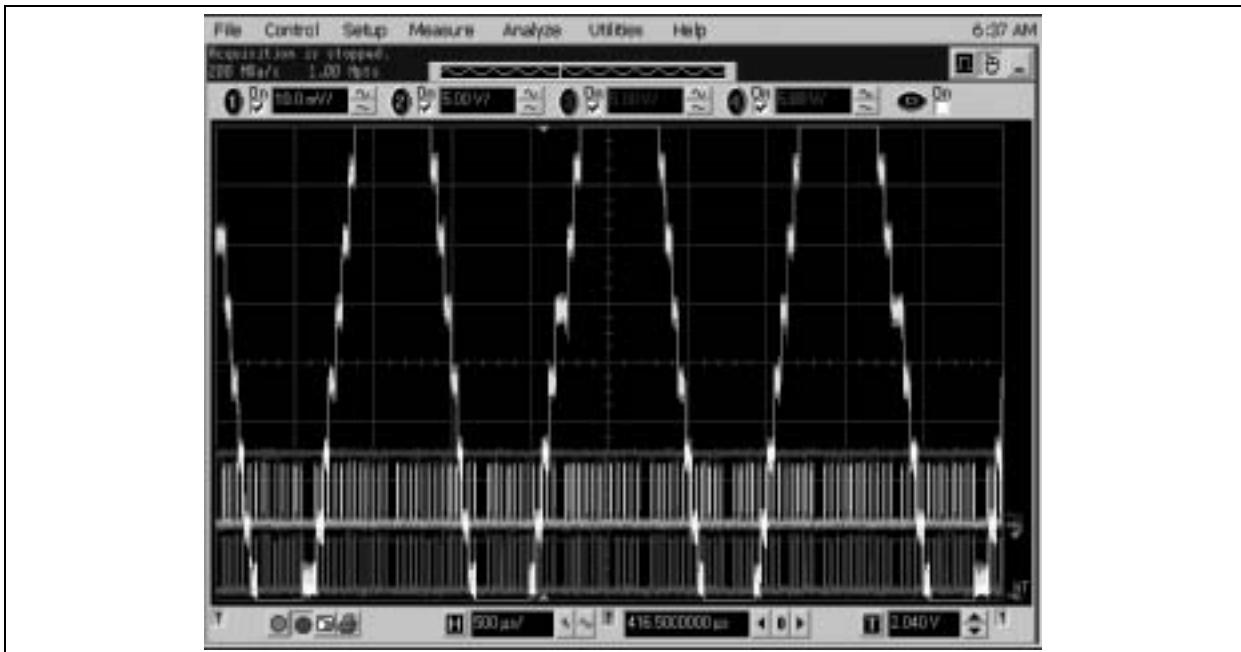

FIGURE G-2: Oscilloscope screen capture of V_{OUT_D} using the SMA connector and coaxial cable directly to the scope. This is the same as Figure G-1, except the scope probe on V_{OUT_B} is turned off. This highlights how critical test connections are to properly evaluating the “real” noise in a system.

Mixed Signal PICtail™ Demo Board User's Guide

NOTES:

Appendix H. Sine Wave and Filtered DTMF Scope Captures

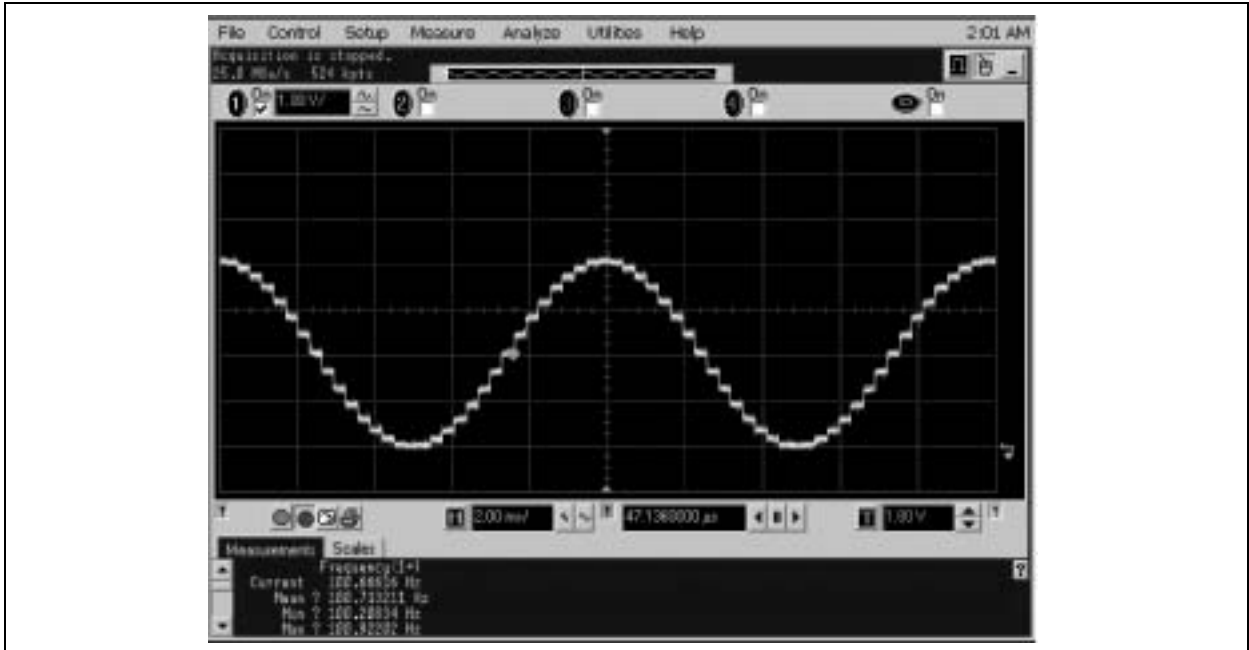

FIGURE H-1: Mode1000b generates a 100 Hz, 32-step sine wave on V_{OUT_C} using the TC132X.

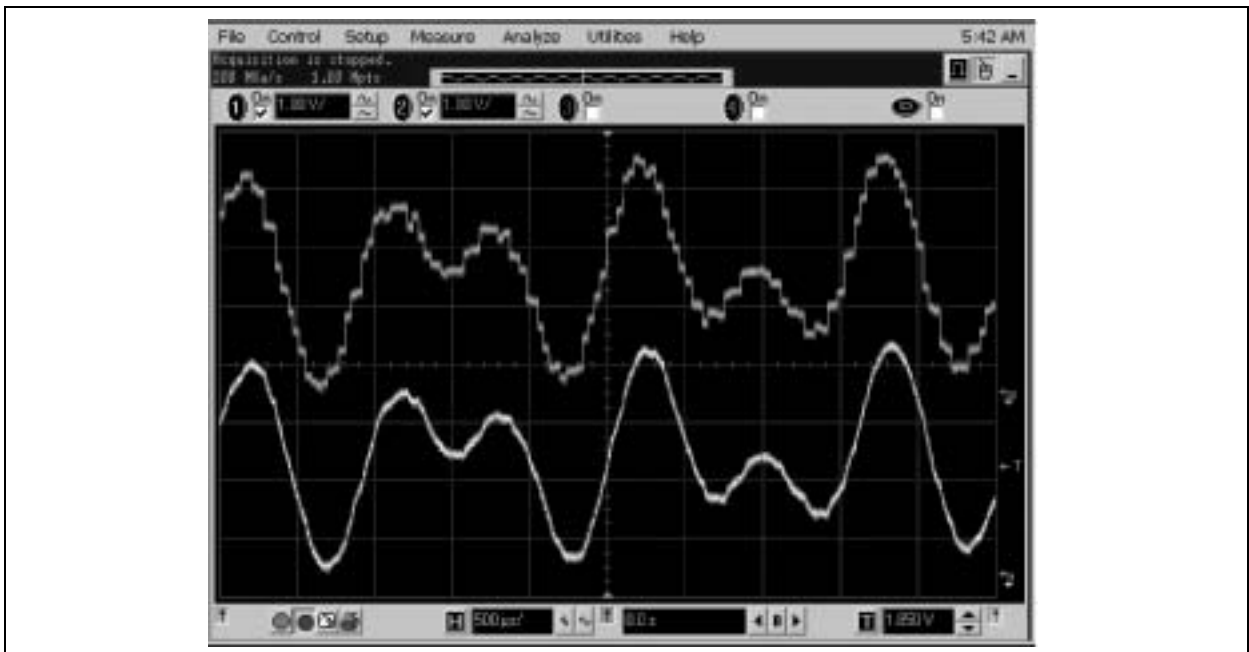

FIGURE H-2: Mode0000b generates DTMF waveforms to repeatedly dial a phone number. V_{OUT_B} illustrates the MCP4922's unfiltered output while V_{OUT_D} illustrates a simple low-pass filter's ability to "clean" up the signal.

Mixed Signal PICtail™ Demo Board User's Guide

NOTES:

Appendix I. MPLAB® IDE Screen Capture

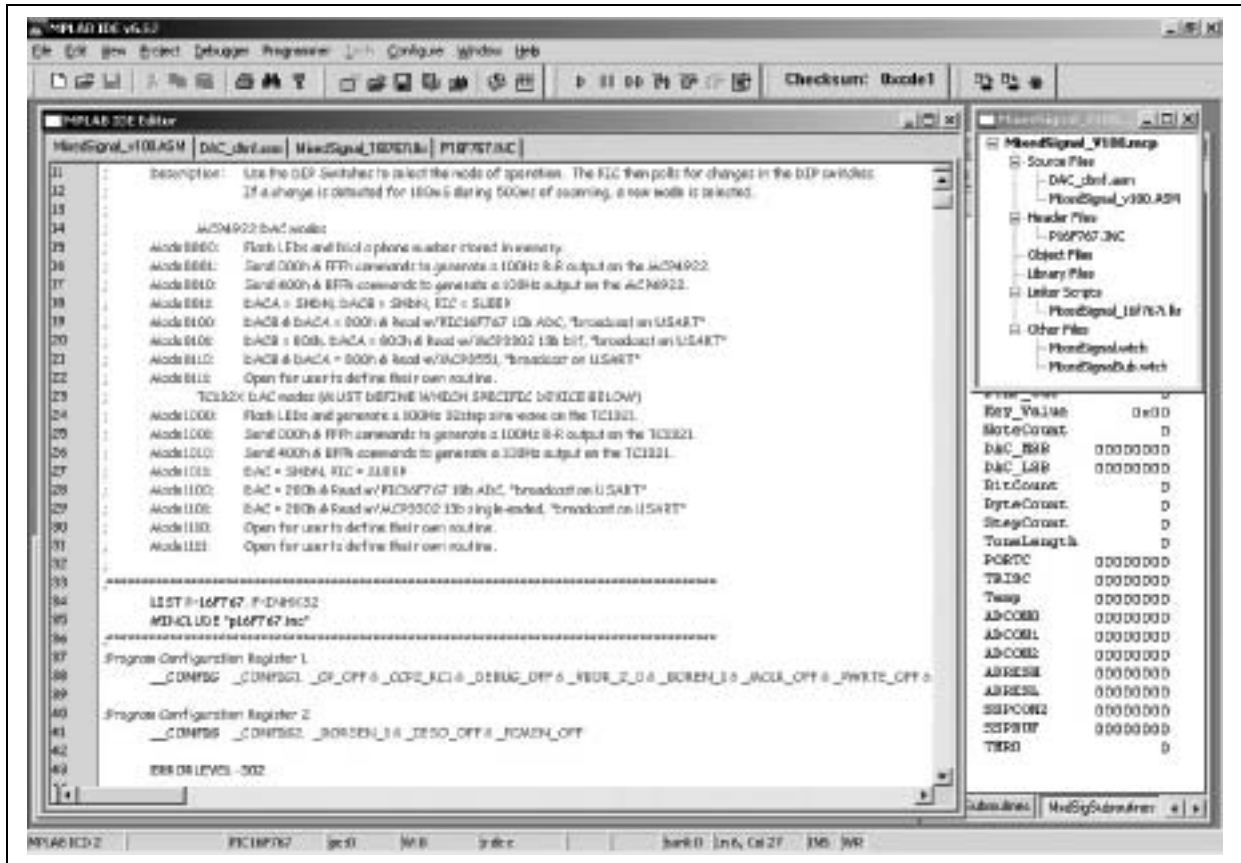

FIGURE I-1: MPLAB® IDE v6.62 screen capture of an example project to build and debug the included firmware. Note the required files in the project window and the two pre-defined Watch windows that the user can open up.



WORLDWIDE SALES AND SERVICE

AMERICAS

Corporate Office

2355 West Chandler Blvd.
Chandler, AZ 85224-6199
Tel: 480-792-7200
Fax: 480-792-7277
Technical Support:
<http://support.microchip.com>
Web Address:
www.microchip.com

Atlanta

Alpharetta, GA
Tel: 770-640-0034
Fax: 770-640-0307

Boston

Westford, MA
Tel: 978-692-3848
Fax: 978-692-3821

Chicago

Itasca, IL
Tel: 630-285-0071
Fax: 630-285-0075

Dallas

Addison, TX
Tel: 972-818-7423
Fax: 972-818-2924

Detroit

Farmington Hills, MI
Tel: 248-538-2250
Fax: 248-538-2260

Kokomo

Kokomo, IN
Tel: 765-864-8360
Fax: 765-864-8387

Los Angeles

Mission Viejo, CA
Tel: 949-462-9523
Fax: 949-462-9608

San Jose

Mountain View, CA
Tel: 650-215-1444
Fax: 650-961-0286

Toronto

Mississauga, Ontario,
Canada
Tel: 905-673-0699
Fax: 905-673-6509

ASIA/PACIFIC

Australia - Sydney

Tel: 61-2-9868-6733
Fax: 61-2-9868-6755

China - Beijing

Tel: 86-10-8528-2100
Fax: 86-10-8528-2104

China - Chengdu

Tel: 86-28-8676-6200
Fax: 86-28-8676-6599

China - Fuzhou

Tel: 86-591-8750-3506
Fax: 86-591-8750-3521

China - Hong Kong SAR

Tel: 852-2401-1200
Fax: 852-2401-3431

China - Shanghai

Tel: 86-21-5407-5533
Fax: 86-21-5407-5066

China - Shenyang

Tel: 86-24-2334-2829
Fax: 86-24-2334-2393

China - Shenzhen

Tel: 86-755-8203-2660
Fax: 86-755-8203-1760

China - Shunde

Tel: 86-757-2839-5507
Fax: 86-757-2839-5571

China - Qingdao

Tel: 86-532-502-7355
Fax: 86-532-502-7205

ASIA/PACIFIC

India - Bangalore

Tel: 91-80-2229-0061
Fax: 91-80-2229-0062

India - New Delhi

Tel: 91-11-5160-8631
Fax: 91-11-5160-8632

Japan - Kanagawa

Tel: 81-45-471-6166
Fax: 81-45-471-6122

Korea - Seoul

Tel: 82-2-554-7200
Fax: 82-2-558-5932 or
82-2-558-5934

Singapore

Tel: 65-6334-8870
Fax: 65-6334-8850

Taiwan - Kaohsiung

Tel: 886-7-536-4818
Fax: 886-7-536-4803

Taiwan - Taipei

Tel: 886-2-2500-6610
Fax: 886-2-2508-0102

Taiwan - Hsinchu

Tel: 886-3-572-9526
Fax: 886-3-572-6459

EUROPE

Austria - Weis

Tel: 43-7242-2244-399
Fax: 43-7242-2244-393

Denmark - Ballerup

Tel: 45-4450-2828
Fax: 45-4485-2829

France - Massy

Tel: 33-1-69-53-63-20
Fax: 33-1-69-30-90-79

Germany - Ismaning

Tel: 49-89-627-144-0
Fax: 49-89-627-144-44

Italy - Milan

Tel: 39-0331-742611
Fax: 39-0331-466781

Netherlands - Drunen

Tel: 31-416-690399
Fax: 31-416-690340

England - Berkshire

Tel: 44-118-921-5869
Fax: 44-118-921-5820

X-ON Electronics

Largest Supplier of Electrical and Electronic Components

Click to view similar products for [Data Conversion IC Development Tools](#) category:

Click to view products by [Microchip](#) manufacturer:

Other Similar products are found below :

[EVAL-AD7265EDZ](#) [EVAL-AD7719EBZ](#) [EVAL-AD7767-1EDZ](#) [EVAL-AD7995EBZ](#) [AD9211-200EBZ](#) [AD9251-20EBZ](#) [AD9251-65EBZ](#)
[AD9613-170EBZ](#) [AD9629-20EBZ](#) [AD9716-DPG2-EBZ](#) [AD9737A-EBZ](#) [AD9993-EBZ](#) [DAC8555EVM](#) [EVAL-AD5061EBZ](#) [EVAL-](#)
[AD5062EBZ](#) [EVAL-AD5443-DBRDZ](#) [EVAL-AD5570SDZ](#) [EVAL-AD7992EBZ](#) [EVAL-AD7994EBZ](#) [AD9119-MIX-EBZ](#) [AD9233-125EBZ](#)
[AD9629-80EBZ](#) [AD9650-80EBZ](#) [AD9767-EBZ](#) [DAC8531EVM](#) [LM96080EB/NOPB](#) [EVAL-AD5445SDZ](#) [EVAL-AD5660EBZ](#) [EVAL-](#)
[AD7685SDZ](#) [EVAL-AD7687SDZ](#) [MAX5318PMB#](#) [MAX1246EVL11-QSOP](#) [MAX117EVKIT-DIP](#) [DC2365A-C](#) [DC2795A-B](#) [DC2795A-A](#)
[DAC088S085EB/NOPB](#) [SIM8909-EVB-KIT](#) [82635ASRCDVKHV 961443](#) [DC1466B-B](#) [EVAL-AD5413SDZ](#) [ADC12D1600RB/NOPB](#) [1083](#)
[RFPDK FOR CMT2X5X](#) [TS7003DB](#) [TSC2014EVM-PDK](#) [MOD-USB3G](#) [KDC5514EVALZ](#) [650201392G](#) [ISL28005FH-100EVAL1Z](#)