

**PD70201EVB25FX**  
**25W Isolated Flyback Converter PD**  
**Evaluation Board User Guide**  
Revision 3.1



**PRODUCTION DATA** – Information contained in this document is proprietary to Microsemi and is current as of publication date. This document may not be modified in any way without the express written consent of Microsemi. Product processing does not necessarily include testing of all parameters. Microsemi reserves the right to change the configuration and performance of the product and to discontinue product at any time.



Table of Contents

**1 ABOUT THIS GUIDE .....3**

1.1 Audience .....3

1.2 Organization .....3

1.3 Reference Documents .....3

**2 INTRODUCTION .....4**

2.1 Evaluation Boards Ordering Information .....5

2.2 Evaluation Board Features .....5

2.3 Physical Characteristics .....5

**3 PHYSICAL DESCRIPTION .....6**

3.1 Package Contents .....6

3.2 Connectors .....6

3.3 Indications .....8

**4 ELECTRICAL CHARACTERISTICS .....9**

**5 INSTALLATION .....10**

5.1 Preliminary Considerations and Safety Precautions .....10

5.2 Initial Configuration .....10

**6 BOARD TEST WAVEFORMS .....11**

**7 PD70201EVB25F12 EFFICIENCY .....19**

7.1 Efficiency for 42.5V Input at the Input Connector .....19

7.2 Efficiency for 48V Input at the Input Connector .....20

7.3 Efficiency for 57V Input at the Input Connector .....20

**8 PD70201EVB25F5 EFFICIENCY .....21**

8.1 Efficiency for 42.5V Input at the Input Connector .....21

8.2 Efficiency for 48V Input at the Input Connector .....22

8.3 Efficiency for 57V Input at the Input Connector .....22

**9 SCHEMATICS .....23**

**10 LIST OF MATERIALS .....25**

**11 BOARD LAYOUT .....29**



## 1 About this Guide

This user guide provides both a description and operating procedures for Microsemi's PD70201EVB25FX board.

This board type is used for evaluating the performance of PD70201 device.

PD70201ILQ device supports both the standard 802.3at PD application interface, and a PWM controller that is used for the PD operational voltages DC/DC.

The board supports a 25 Watt, 5V or 12V output which differs by assembly version.

### 1.1 Audience

This user guide is intended for qualified personnel, that is, operators and technicians who have a background in basic concepts of electronics.

### 1.2 Organization

This guide is arranged according to the following:

- Chapter 0 **About this Guide:** Provides general information about the guide including audience, organization and reference documents.
- Chapter 2 **Introduction:** Provides an overview about evaluation board's main functions, features, physical characteristics and ordering information.
- Chapter 3 **Physical Description:** Provides explanation related to the physical description (switches, jumpers, connectors).
- Chapter 4 **Electrical Characteristics:** Provides electrical characteristics of the evaluation board.
- Chapter 5 **Installation:** Provides a description of the installation process.
- Chapter 6 **Board Test :** Provides board efficiency information.
- Chapter 7 **PD70201EVB25F12 Efficiency:** Provides board efficiency information.
- Chapter 8 **PD70201EVB25F5 Efficiency:** Describes typical EVB efficiency under various loads and POE input voltage levels.
- Chapter 9 **Schematic:** Provides a board schematic diagram.
- Chapter 10 **List of Materials:** Provides the board's list of materials.
- Chapter 11 **Board Layout:** Provides board Gerber files description for all layers.

### 1.3 Reference Documents

- PD70201 datasheet, catalogue number DS\_PD70101A\_70201



## 2 Introduction

Microsemi's PD70201ILQ device is part of a family of devices which are targeted for realizing the 802.3at standard PD interface.

The PD interface family of devices includes the following:

Device type	Power Capability	Integrates PWM Controller	WA_EN support
PD70100/A	IEEE 802.3at Type 1 (IEEE 802.3 af level)	No	No
PD70101/A	IEEE 802.3at Type 1 (IEEE 802.3 af level)	Yes	No
PD70200	IEEE 802.3at Type 2	No	No
PD70201	IEEE 802.3at Type 2	Yes	No
PD70210	IEEE 802.3at Type 2	No	No
PD70210A	IEEE 802.3at Type 2	No	Yes
PD70211	IEEE 802.3at Type 2	Yes	Yes

Microsemi's PD70201EVB25FX Evaluation Board (see Figure 2) provides designers with the environment needed for evaluating the performance and implementation of PD applications based on the PD70201 device.

The board uses a single PD device, PD70201ILQ, to support the Detection, Class, and Power Supplying phases on the 2/4 Pairs of the Cat5 cable. PD70201ILQ supports a standard IEEE802.3AT Type 2 interface.

All necessary steps and connection instructions required to install and operate this board are provided within this document.

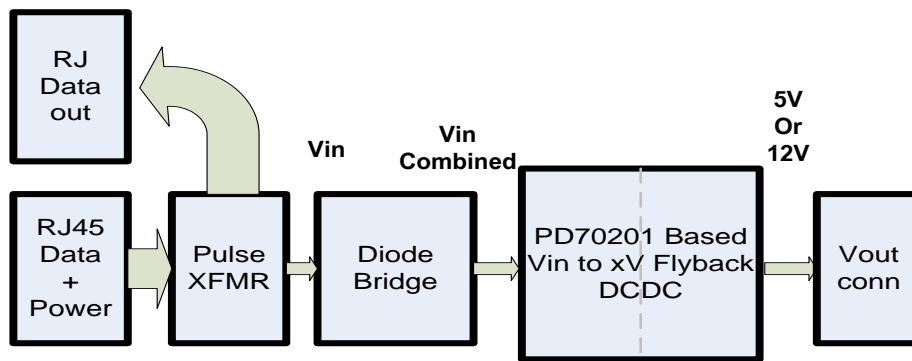

Figure 1: PD70201EVB25FX Block Diagram



**Figure 2: PD70201EVB25FX Evaluation Board – General View**

## 2.1 Evaluation Boards Ordering Information

Microsemi's supplies the following Evaluation Boards:

Ordering Number	Description
PD70201EVB25F5	IEEE802.3AT Type 2 PD, based on PD70201 device, controls an <b>isolated flyback converter</b> , has a <b>5V 5Amp</b> output.
PD70201EVB25F12	IEEE802.3AT Type 2 PD based on PD70201 device, controls an <b>isolated flyback converter</b> , has a <b>12V 2.1Amp</b> output.

## 2.2 Evaluation Board Features

- Designed to support Data and Spare current by a single PD70201 device
- Two RJ45 connectors (Data and Power In, Data Out)
- Output voltage connector.
- On board Power Good LED indicator
- On board AT detected LED indicator
- Pulse transformer for routing the data to PD application to enable full PD evaluation.
- Evaluation Board working temperature: 0° to +70°C
- RoHS compliant

## 2.3 Physical Characteristics

Table 1 lists the evaluation board's physical characteristics.

**Table 1: Physical Characteristics**

Parameter	Value
Mechanical dimensions in mm	81 x 65 x 15mm (L x W x H)



### 3 Physical Description

#### 3.1 Package Contents

Upon opening the Evaluation Board package, verify the following part is included; If it seems damaged, contact your local representative or Microsemi's headquarters.

Package content for standard shipments is:

PD70201EVB25FX Evaluation Board

#### 3.2 Connectors

The following sections provide both general and detailed information regarding unit's connectors.

##### 3.2.1 Connectors Table

Table 2 lists the Evaluation Board's connectors.

Table 2: Connectors List

#	Connector	Name	Description
1	CON1	RJ45 Connector	RJ45 port for Data and Power In for PSE connection
2	CON2	RJ45 Connectors	RJ45 port for Data Out for PD data connection
4	J1	Converter Output	Terminal blocks for connecting a load to output regulator

##### 3.2.2 Connectors Detailed Explanation

The numbering is in reference to the numbers listed in Table 2.

###### 1. RJ45 Connectors

There are two dedicated RJ45 connectors, See Figure 3.

Table 3: RJ45 Connectors

CON2 Pin No	Signal Name	Description
1, 2, 3, 4, 5, 6, 7, 8	Data Out	Data output to PD
CON1 Pin No	Signal Name	Description
1, 2	Data and Power In	Data and power input to powered device (PoE Master Negative data port)
3, 6	Data and Power In	Data and power input to powered device (PoE Master Positive data port)
4, 5	Data and Power In	Data and power input to powered device (PoE Master Positive data port)
7, 8	Data and Power In	Data and power input to powered device (PoE Master Negative data port)



**Figure 3: Front RJ45 and Wall Adapter Connectors**

## 2. $V_{out}$ Connectors

See Figure 4.

J1 – DCDC output connection, used for connecting to external load.

**Table 4: J1 Connector**

Pin No.	Signal Name	Description
J1 (Left)- Pin 1	Vout	Positive DCDC output voltage
J1 (Right)-Pin 2	Vout_Rtn	Return of DCDC output voltage



**Figure 4:  $V_{out}$  Connectors**



### 3.3 Indications

The following sections provide general information regarding unit indications.

#### 3.3.1.1 LED Indication

See Figure 5.

D5 is the Power\_GOOD indication LED, a PD70201 device output signal indicating if the device isolation switch is in operation. The PWM converter should be turned on only after this signal is active.

D9 is the AT flag indication LED, a PD70201 device output signal indicating that the device has detected two fingers class, thus PSE side is AT level capable. This signal is an indication to the PD environment that AT power level is supported.

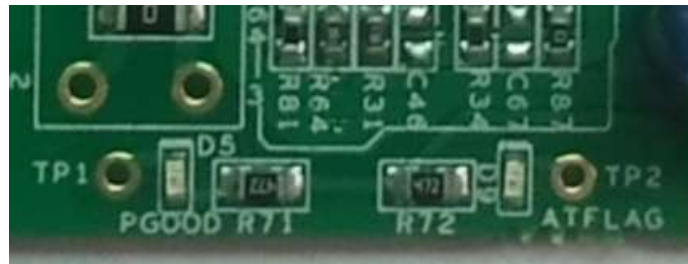

Figure 5: LED Indications





## 4 Electrical Characteristics

Evaluation board's electrical characteristics are described below:

**Table 5: Electrical Characteristics**

Parameter	Min	Max	
Main DC Supply – Con1, J2	42	57	V
Maximum Available Current	12V/2.1A		A
Maximum Available Current	5V/5A		A
Port Isolation to Chassis	-	1.5	kVrms



## 5 Installation

### 5.1 Preliminary Considerations and Safety Precautions

Verify board's power supply is turned "off" before all peripheral devices are connected.

**Note:** In maximum power at the output, some of the devices may reach high temperatures (still less than 70 degrees). Pay attention while testing these devices.

### 5.2 Initial Configuration

**Note:** Prior to starting any operation, it is important to verify that the Evaluation Board is setup as shown in Figure 6.

1. Connect load to main board (J1).
2. Connect a Cat5 cable from PSE to Evaluation Board (CON1). Alternatively connect a power cable from Power supply to Evaluation Board (J2).
3. When there is a need to test the Ethernet data, connect Ethernet cable from Evaluation Board (CON2) to PD Ethernet Host.

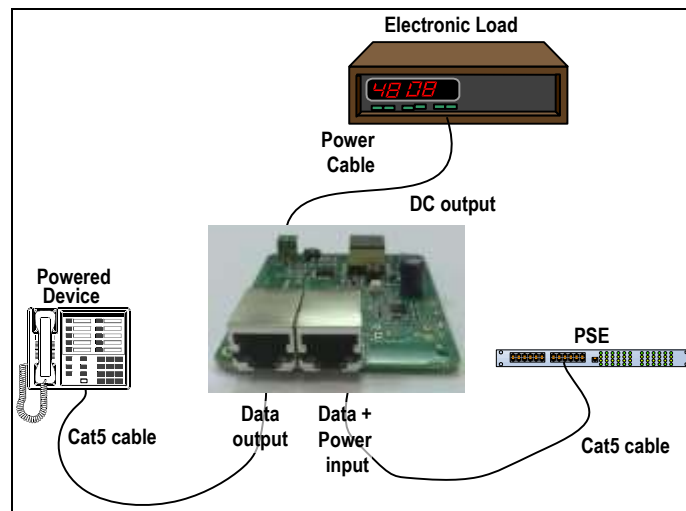

Figure 6: Test Setup



## 6 Board Test Waveforms

This paragraph presents snapshots of the signals on 5V and 12V boards. Waveforms were dumped in Microsemi's lab on a single board. Minor changes might be avoidances based on test setup and device variance.

Output voltage ripple at Full load: 32 mV peak to peak.

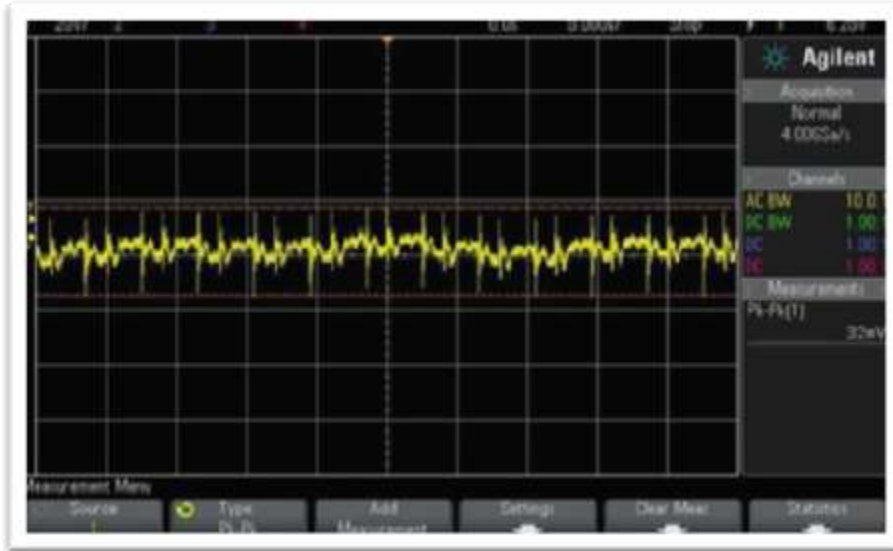

Figure 7: 12V/25W Flyback Output Voltage Ripple at Full Load

Output voltage ripple at Full load: 90 mV peak to peak.

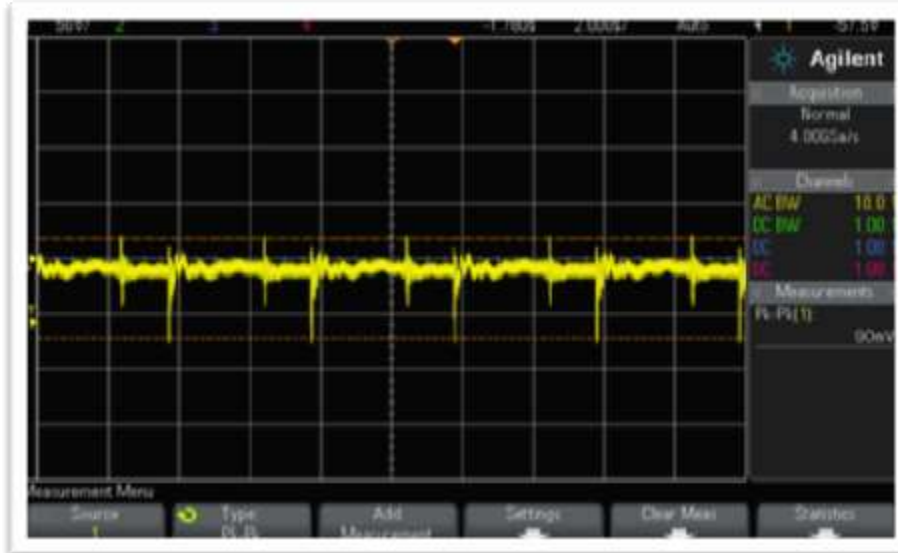
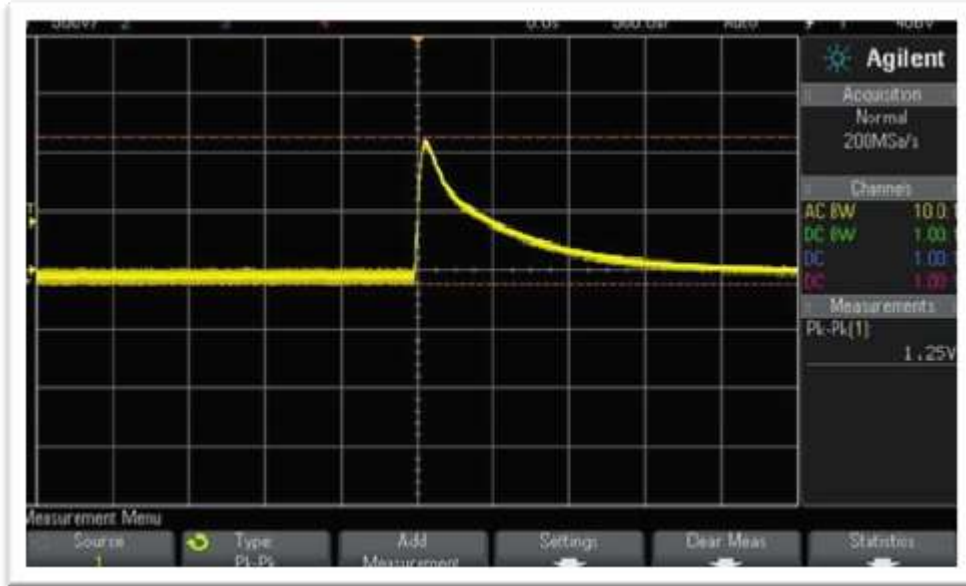

Figure 8: 5V/25W Flyback Output Voltage Ripple at Full Load

Output voltage at Load switching from 90% to 20%:

1.25 volt rise for 1.5 mSec.



**Figure 9: 12V/25W Flyback Output Voltage at Load Switching from 90% to 20%**

0.5 volt rise for 0.3 mSec.

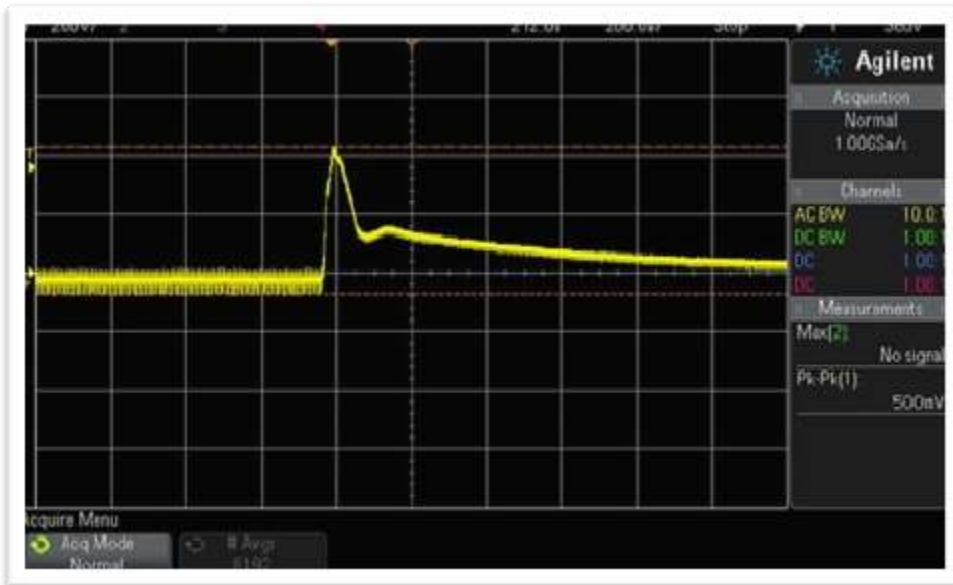

**Figure 10: 5V/25W Flyback Output Voltage at Load Switching from 90% to 20%**

Output voltage at Load switching from 20% to 90%:

1.47 volt drop for 1.5 mSec

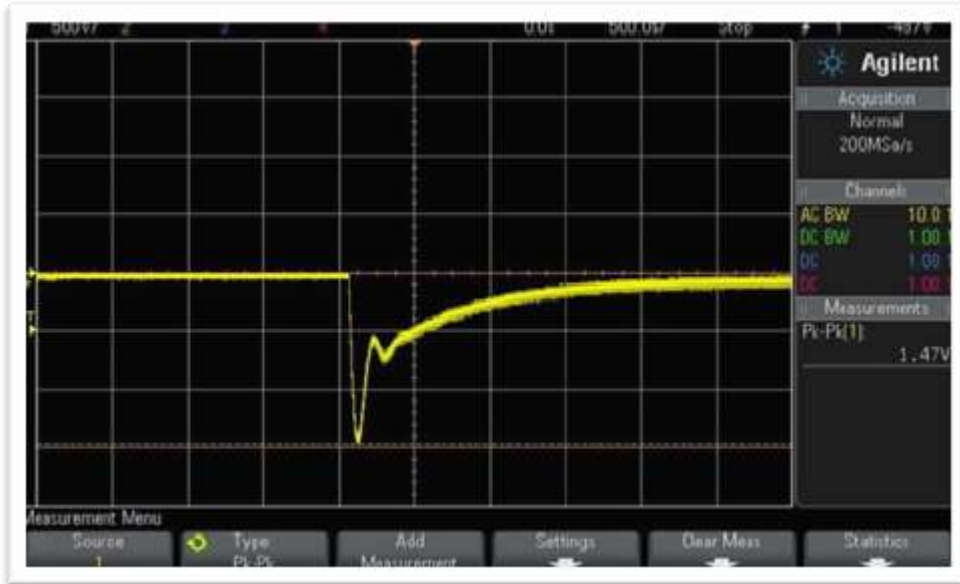

**Figure 11: 12V/25W Flyback Output Voltage at Load Switching from 20% to 90%**

0.6 volt drop for 0.3 mSec

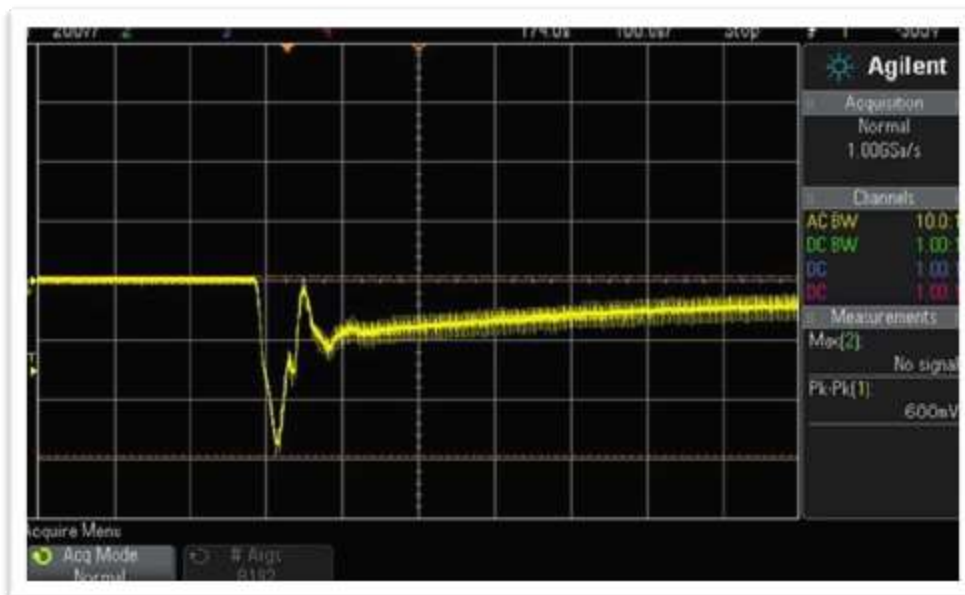

**Figure 12: 5V/25W Flyback Output Voltage at Load Switching from 20% to 90%**



Primary FET switching signal Plus Secondary FET switching signal:  
Channel 1 is primary FET gate and channel 2 is secondary FET gate.



Figure 13: 12V/25W Flyback Primary and secondary Fets Gate



PD70201EVB25F12 Output Voltage Line regulation:

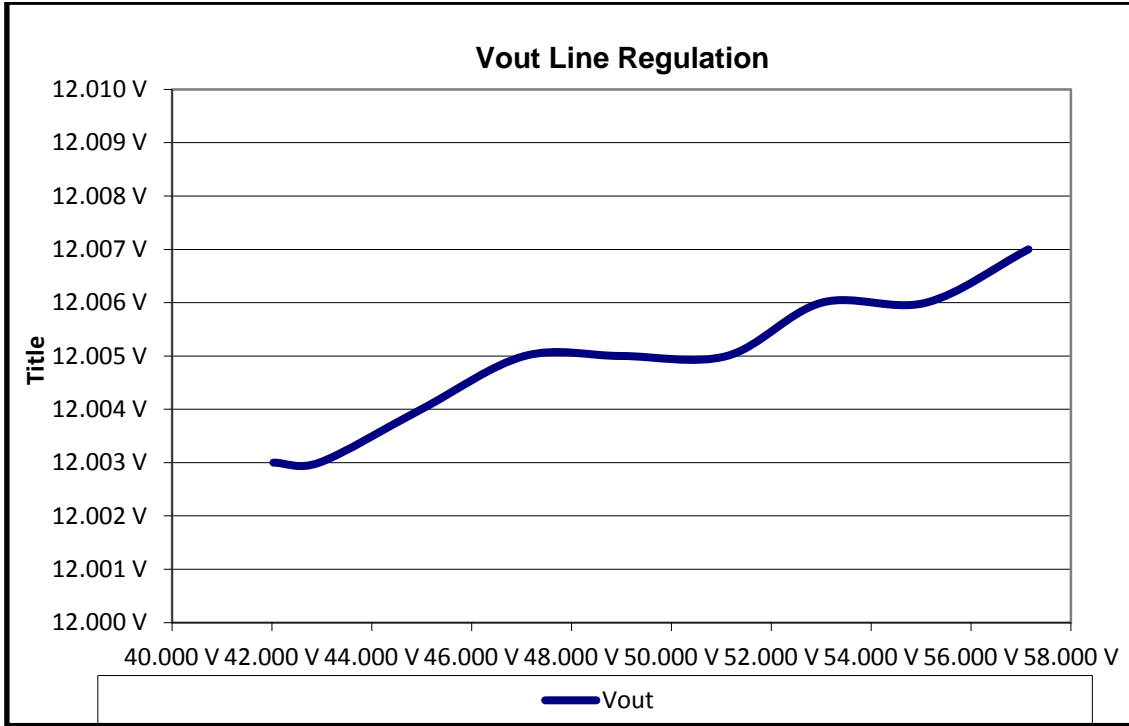

Figure 14: Output Voltage as a Function of Vin Voltage





PD70201EVB25F12 Output Voltage Load Regulation:

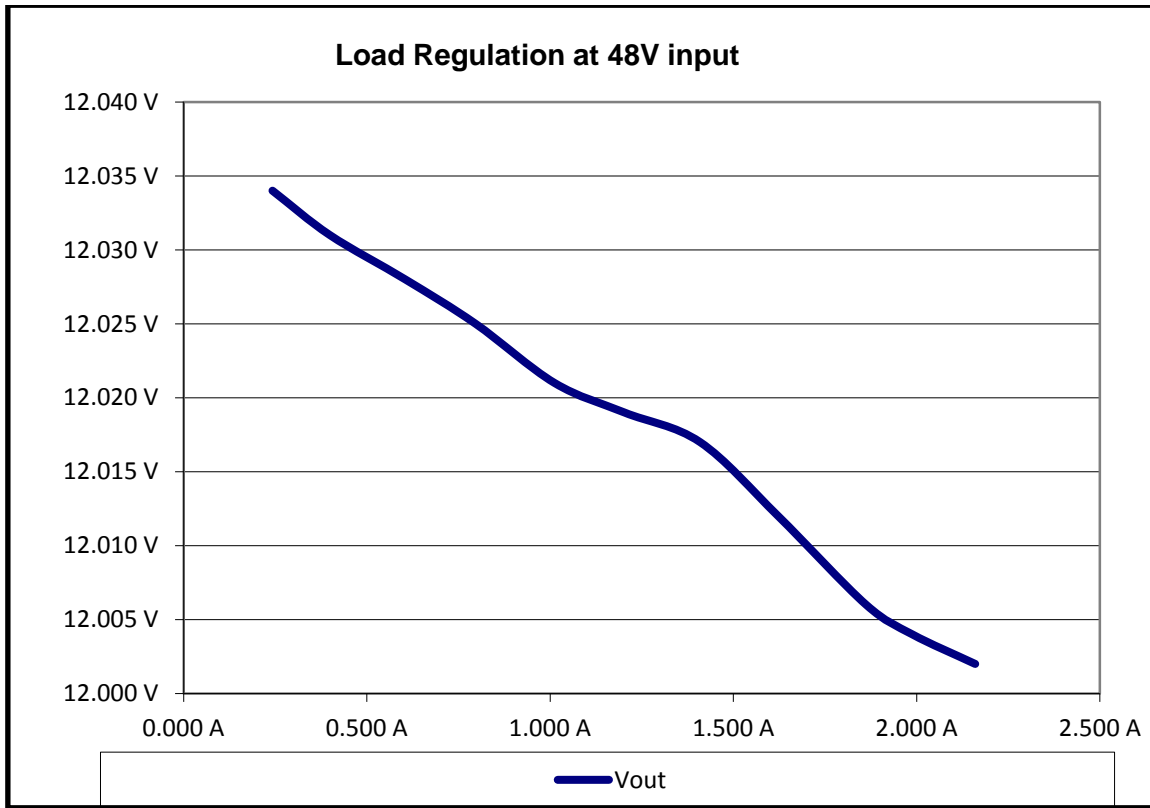

Figure 15: Output Voltage as a Function of the Load Current



PD70201EVB25F5 Output Voltage Line regulation:

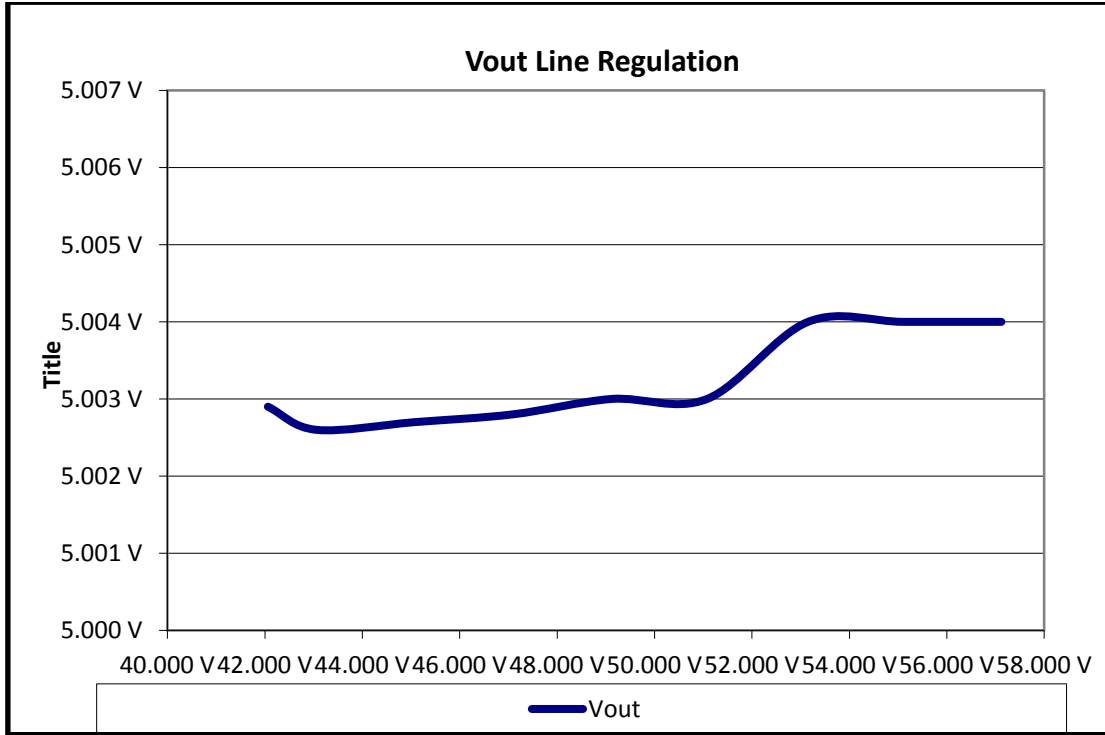

Figure 16: Output Voltage as a Function of Vin Voltage

PD70201EVB25F5 Output Voltage Load regulation:

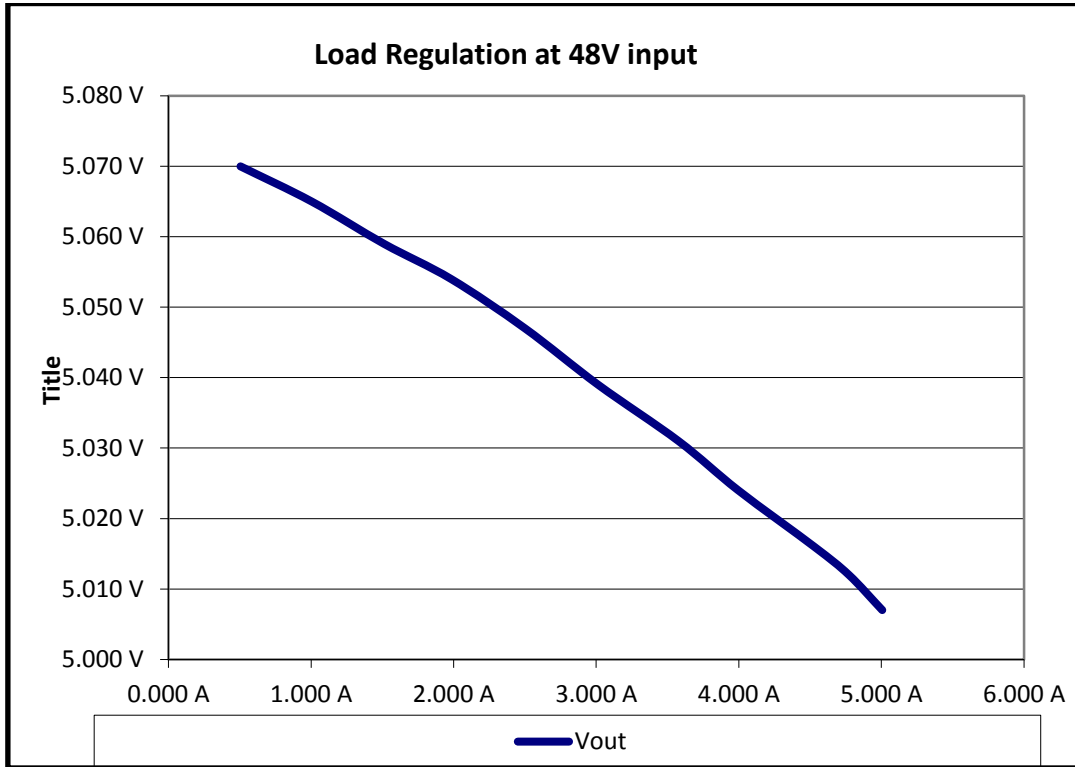

Figure 17: Output Voltage as a Function of the Load Current



## 7 PD70201EVB25F12 Efficiency

This chapter describes typical EVB efficiency under various loads and POE input voltage levels.

The information is presented by two modes:

Total Eff – Efficiency measured between RJ45 input Connector and Output voltage connector. It does not include losses in the connectors.

$$Total\ Eff = \frac{V_{out} * I_{out}}{V_{in} * I_{in}}$$

PD+DCDC Eff – Efficiency measured between Diode bridge output and Output voltage connector. It does not include the losses in the connectors, line transformer and diode bridges.

$$PD\_DCDC\ Eff = \frac{V_{out} * I_{out}}{V_{ppout} * I_{in}}$$

### 7.1 Efficiency for 42.5V Input at the Input Connector

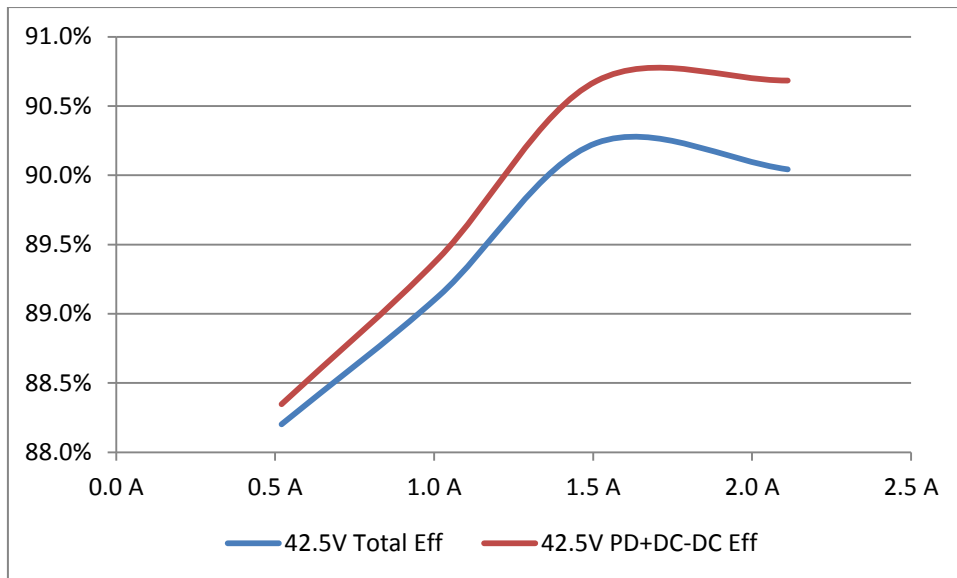

Figure 18: PD70201EVB25F12 Efficiency at 42.5V

### 7.2 Efficiency for 48V Input at the Input Connector

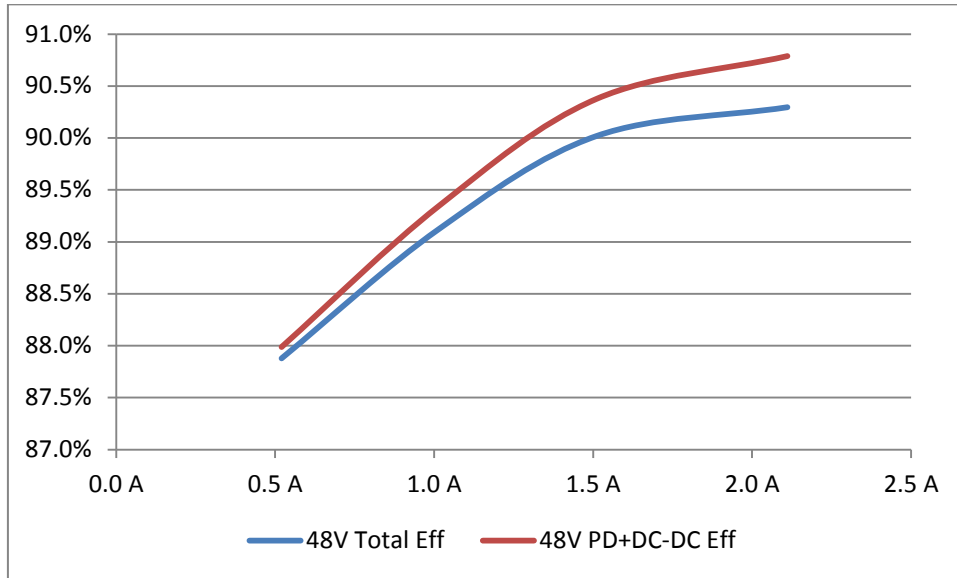

Figure 19: PD70201EVB25F12 Efficiency at 48V

### 7.3 Efficiency for 57V Input at the Input Connector

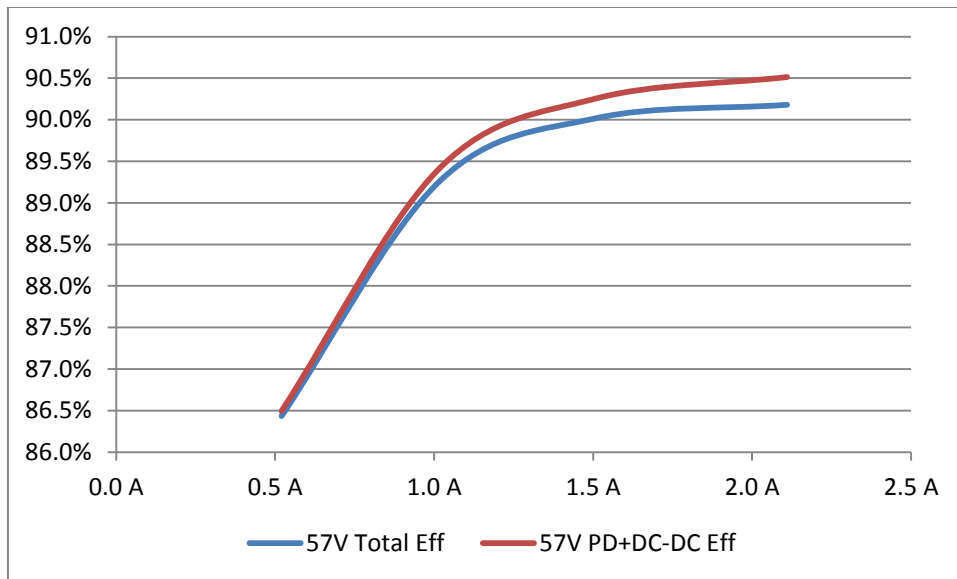

Figure 20: PD70201EVB25F12 Efficiency at 57V



### 8 PD70201EVB25F5 Efficiency

This chapter describes typical EVB efficiency under various loads and POE input voltage levels.

The information is presented by two modes:

Total Eff – Efficiency measured between RJ45 input Connector and Output voltage connector (it does not include losses in the connectors).

$$Total\ Eff = \frac{V_{out} * I_{out}}{V_{in} * I_{in}}$$

PD+DCDC Eff – Efficiency measured between Diode bridge output and Output voltage connector. It does not include the losses of the input connector, line transformer and diode bridges.

$$PD\_DCDC\ Eff = \frac{V_{out} * I_{out}}{V_{ppout} * I_{in}}$$

#### 8.1 Efficiency for 42.5V Input at the Input Connector

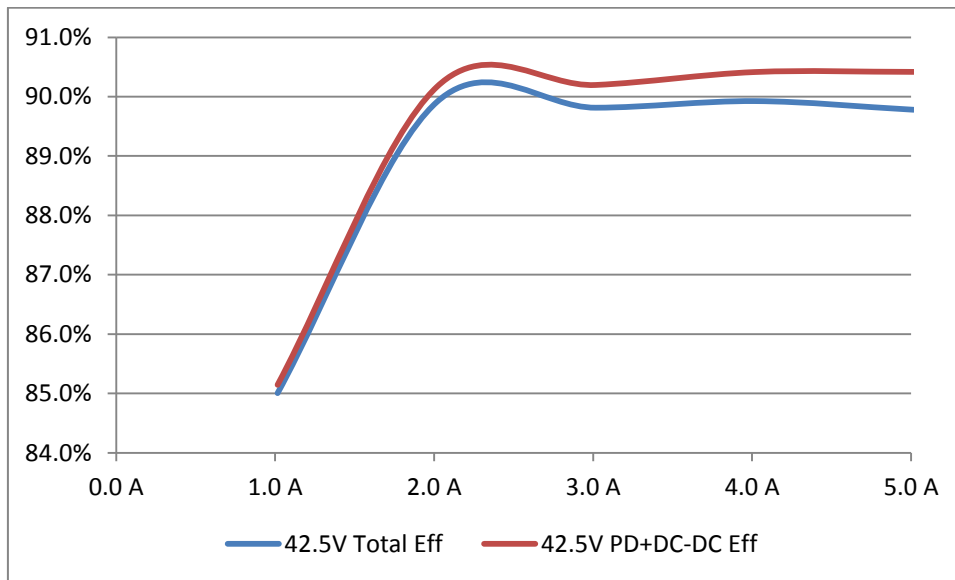

Figure 21: PD70201EVB25F5 Efficiency at 42.5V

### 8.2 Efficiency for 48V Input at the Input Connector

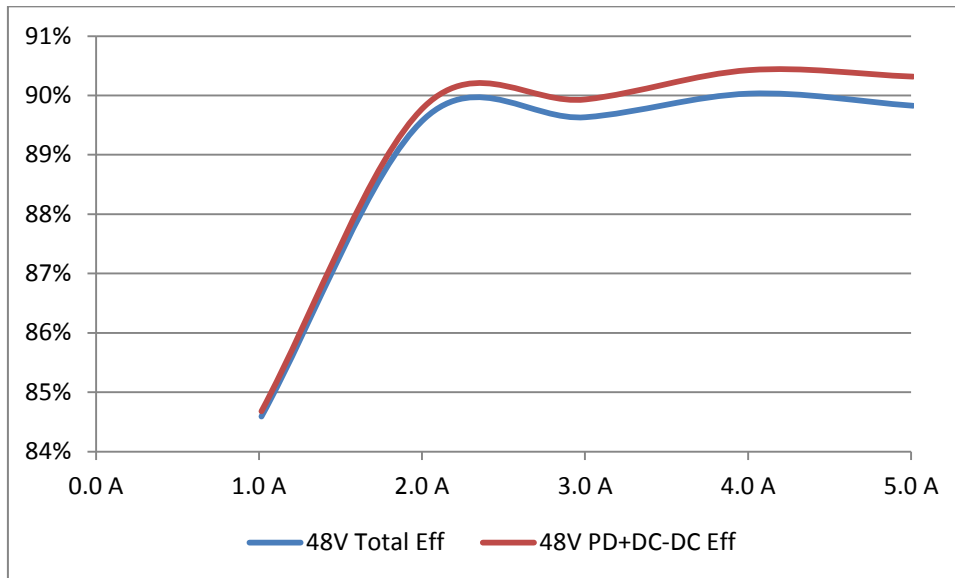

Figure 22: PD70201EVB25F5 Efficiency at 48V

### 8.3 Efficiency for 57V Input at the Input Connector

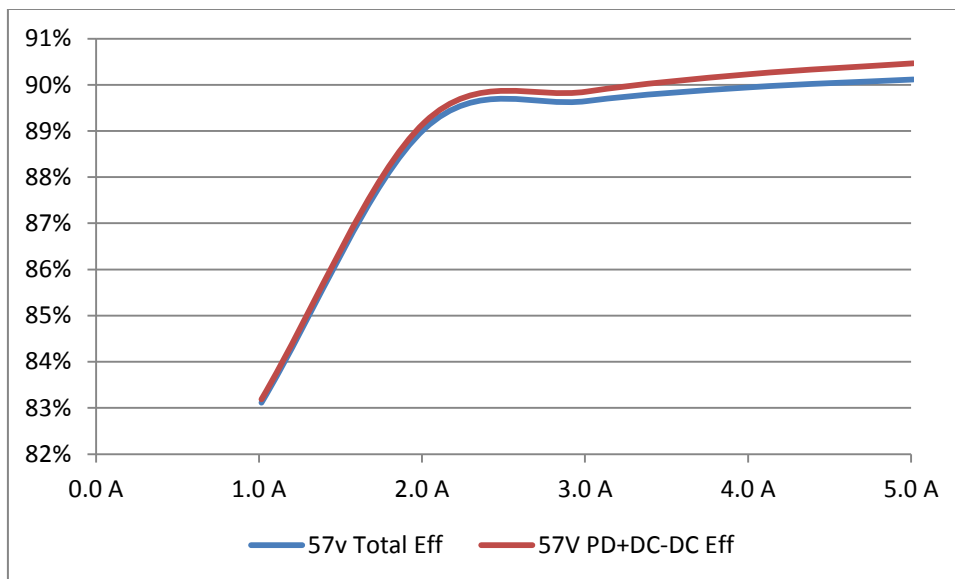

Figure 23: PD70201EVB25F5 Efficiency at 57V







Microsemi

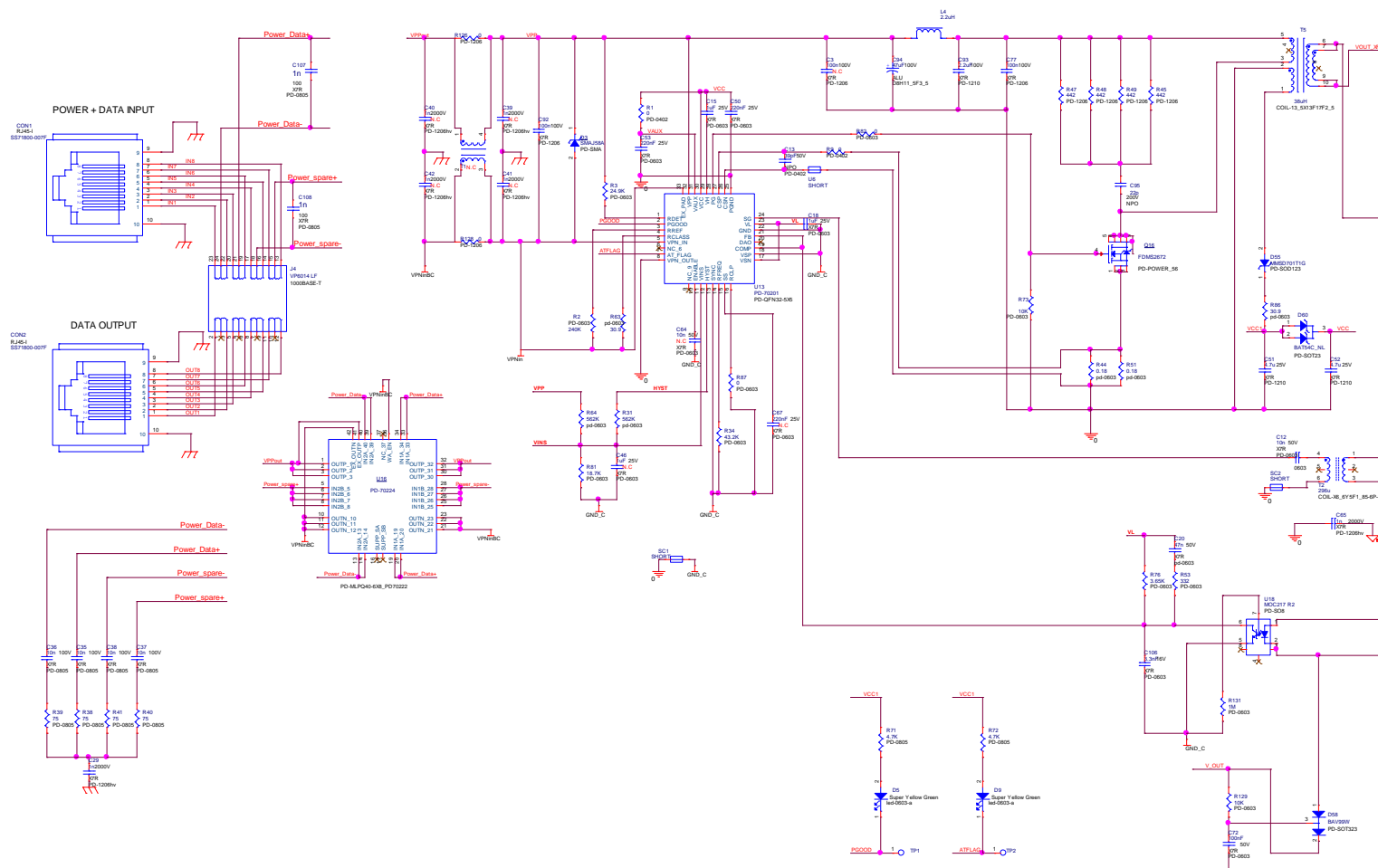

Fig.25. Schematic of PD70201EVB25F-12.

Copyright © 2016  
Rev. 3.0, 17.1.2016

Microsemi  
CPG – PoE BU  
One Enterprise Aliso Viejo, CA 92656 USA  
CONFIDENTIAL



## 10 List of Materials

- First table specifies PD70201EVB25F5 devices.
- Second table specifies PD70201EVB25F12 devices.

**Table 6: PD70201EVB25F5 Assembly**

Item	Description	Qty	Ref Des	Mfr. Name	Mfr. Part Number
1	AT POE PD controller for IEEE 802.3 PD70201	1	U13	Microsemi	PD70201ILQ-TR.
2	DIO BRIDGE 100V 1A SMT	2	D6,D7	Vishay	DF01S-E3/45
3	CAP CRM 4.7n 100V 10% 0805 SMT X7R	1	C95	Vishay	VJ0805A680KXCAT
4	Capacitor 820pF 200V 10% X7R 0805 SMT	1	C96	AVX	08052C821KAT2A
5	CAP CRM 10nF 100V 5% X7R 0805 SMT	4	C35-C38	AVX	08051C103JAT2A
6	CAP CRM 22uF 10V 20% X5R 1206 SMT	9	C54-C58, C102-C105	AVX	1206ZD226MAT2A
7	CAP CRM 1nF/2000V 10%++X7R 1206 SMT	2	C29,C65	AVX	1206GC102KAT1A
8	CAP CRM 100nF 100V 10% X7R 1206 SMT	2	C77,C92	AVX	12061C104KAT2A
9	CAP CER 39PF 50V 5% C0G 0402	1	C13	AVX	04025A390JAT2A
10	Capacitor, X7R, 4.7uF, 25V, 10% 1210	2	C51, C52	Murata	GRM32DR71E475KA61L
11	CAP CER 2.2uF 100V 10% X7R 1210 SMT	1	C93	CAPAX	1210X225K101SNT
12	CAP COG 100pF 50V 5% 0603	1	C19	AVX	06035A101JAT2A
13	Capacitor, X7R, 3.3nF, 16V, 10% 0603	1	C106	Murata	GRM188R71H332KA01
14	CAP CRM 100nF 50v 10% X7R 0603	1	C72	Meritek	MA0603XR104K500
15	CAP 220NF 25V X7R 10% 0603	2	C50,C53	Murata	GRM188R71E224KA88D
16	Capacitor, X7R, 47nF, 50V, 10% 0603	1	C20	AVX	06035C473KAT2A
17	Capacitor, X7R, 1uF, 25V, 10% 0603	2	C15,C18	Murata	GRM188R71E105KA12D
18	CAP CRM 10nF 50v 10% X7R 0603 SMT	3	C11,C12,C17	EPCOS	B37931-K5103-K60
19	CAP ALU 47uF 100V 20% 8X11.5 105C P=3.5mm T/H	1	C94	Nichicon	UVY2A470MPD1CA
20	CON RJ45 SINGLE 8 POS. SHILDED	2	CON1,CON2	Bel Stewart	SS71800-007F
21	Terminal block 2 Pole interlocking 3.5mm pitch	1	J1	DECA	MB332-350M02
22	Diode Dual BAT54C	1	D60	Diodes Inc.	BAT54C
23	Diode, Dual Switching BAV99W SOT323	1	D58	Diodes Inc.	BAV99W-7-F
24	DIODE Zener 28V SMT	1	D59	Diodes Inc.	MMSZ5255B-7-F
25	DIODE SCHOTTKY 70V 0.2A,225 W, SOD123	1	D55	ON Semiconductor	MMSD701T1G
26	DIODE SCHOTTKY 40V 500mA SOD123 REC. SMT	2	D4,D8	ON Semiconductor	MBR0540T1G
27	IC Prog Shunt Ref 2.5V 2% SOT23-5 SMT	1	D14	TI	TL431CDBVRE4
28	IC, N-CH POWER MOSFET 150v 4.1A SO8	1	Q3	Fairchild	FDS86242
29	1000 BASE T SINGLE PORT MAGNETICS SMT	1	J4	BOTHHAND	VP6014 HF
30	Power Inductors 2.2uHy 1.5A 110mOhm SMT Shielded	1	L4	Coilcraft	LPS3015-222MR
31	Power Inductor 0.33uH 20A Shielded SMT	1	L1	Bourns	SRP7030-R33M
32	Transformer, Gate driver SMT 269uH 0.795 DCR	1	T2	Coilcraft	DA2319-AL
33	TRANS FLYBACK POE+ 38UH SMD PRI RES0.082 ohm	1	T5	WURTH ELEKTRONIK	750310744
	alternate			Tesla Magnetics	TX4014



Microsemi

34	LED SuperYelGrn 100-130o 20-40mcd h=1 0603 SMD	2	D5,D9	Everlight	19-21-SYGCS530E3TR8
35	IC OPTOISOLATOR MOC217	1	U18	Fairchild	MOC217R2-M
36	RES 75R 125mW 1% 0805 SMT	4	R38-R41	Bourns	CR0805-FX-75R0-E
37	Resistor, 0 Ohm, 5%, 1/16W 0402	2	R1,R9	ASJ	CR10-000ZK
38	RES 0R 250mW 5% 1206 SMT JUMPER<0.05R	2	R126,R128	Samsung	RC3216J000CS
39	RES TK FLM 4.7k 0805 SMT	2	R71,R72	Bourns	
40	RES TCK FLM 40.2K 250mW 1% 1206 SMT	4	R45,R47-R49	Rohm	MCR18EZPF4022
41	RES 8.2 OHM 1/2W 5% 1210 SMT	1	R130	KOA	RK73B2ETTD8R2J
42	RES TCK FLM 0R 62.5mW 5% 0603 SMT	2	R82,R87	ASJ	CR16-000ZL
43	RES TCK FLM 24.9K 62.5mW 1% 0603 SMT	1	R3	ASJ	CR16-2492FL
44	RES 43.2K 100mW 0603 SMT 1%	1	R34	ASJ	CR16-4322FL
45	Resistor, 18.7K, 1%, 1/16W 0603	1	R81	ASJ	CR16-1872FL
46	Resistor, 30.9R 1%, 1/10W 0603	2	R63,R86	KOA	RK73H1JTDD30R9F
47	RES TCK FLM 5.1K 62.5mW 1% 0603 SMT	1	R55	ASJ	CR16-5101FL
48	RES 562K, 1%, 1/16W, 0603	2	R31,R64	ASJ	CR16-5623FL
49	RES 3.65K 0.1W 1% 0603 SMT MTL FLM	1	R76	ASJ	CR16-3651-FL
50	Resistor, 240K, 1%, 1/10W 0603	1	R2	KOA	RK73H1JTDD2403F
51	Resistor, SMT 56K, 1%, 1/10W 0603	2	R52,R54	KOA	RK73H1JTDD5602F
52	RES TCK FLM 0.18R 0.1W 1% 0603 SMT	2	R44,R51	Bourns	CRL0603-FW-R180ELF
53	RES 4.75R 0.1W 1% 0603 SMT MTL FLM	1	R84	Samsung	RC1608F4R75CS
54	RES 332R 62.5mW 1% 0603 SMT MTL FLM	1	R53	ASJ	CR16-3320FL
55	RES 511R 100mW 1% 0603 SMT MTL FLM 100 ppm	1	R77	Panasonic	ERJ3EKF5110V
56	RES 10K 62.5mW 1% 0603 SMT MTL FLM	3	R36,R73,R129	ASJ	CR16-1002FL
57	RES 1M 62.5mW 1% 0603 SMT MTL FLM	1	R131	ASJ	CR16-1004-FL
58	TRN PNP -30V -1A SOT23	1	Q2	Fairchild	FMMT549
59	N-CH POWER MOSFET with Schottky diode 30V 4mOhm	1	Q4	On Semi	NTMFS4983NFT1G



**Microsemi**

**PD70201EVB25Fx**

25W Isolated Flyback Converter PD

Evaluation Board

**Table 7: PD70201EVB25F12 Assembly**

Item	Description	Qty	Ref Des	Mfr. Name	Mfr. Part Number
1	AT POE PD controller for IEEE 802.3 PD70201	1	U13	Microsemi	PD70201ILQ-TR.
2	DIO BRIDGE 100V 1A SMT	2	D6,D7	Vishay	DF01S-E3/45
3	Capacitor 820pF 200V 10% X7R 0805 SMT	1	C96	AVX	08052C821KAT2A
4	CAP CRM 22pF 200V 10% NPO 0805 SMT	1	C95	Vishay	VJ0805A220KXCAT
5	CAP CRM 10nF 100V 5% X7R 0805 SMT	4	C35-C38	AVX	08051C103JAT2A
6	Capacitor, X5R, 10uF, 25V, 10% 1206	9	C54-C58, C102-C105	Murata	GRM31CR61E106KA12L
7	CAP CRM 1nF/2000V 10%++X7R 1206 SMT	2	C29, C65	AVX	1206GC102KAT1A
8	CAP CRM 100nF 100V 10% X7R 1206 SMT	2	C77, C92	AVX	12061C104KAT2A
9	CAP CER 39PF 50V 5% COG 0402	1	C13	AVX	04025A390JAT2A
10	Capacitor, X7R, 4.7uF, 25V, 10% 1210	2	C51, C52	Murata	GRM32DR71E475KA61L
11	CAP CER 2.2uF 100V 10% X7R 1210 SMT	1	C93	CAPAX	1210X225K101SNT
12	CAP COG 100pF 50V 5% 0603	1	C19	AVX	06035A101JAT2A
13	Capacitor, X7R, 3.3nF, 16V, 10% 0603	1	C106	Murata	GRM188R71H332KA01
14	CAP CRM 100nF 50v 10% X7R 0603	1	C72	Meritek	MA0603XR104K500
15	CAP 220NF 25V X7R 10% 0603	2	C50, C53	Murata	GRM188R71E224KA88D
16	Capacitor, X7R, 47nF, 50V, 10% 0603	1	C20	AVX	06035C473KAT2A
17	Capacitor, X7R, 1uF, 25V, 10% 0603	2	C15, C18	Murata	GRM188R71E105KA12D
18	CAP CRM 10nF 50v 10% X7R 0603 SMT	3	C11, wwwwwwC1 2, C17	EPCOS	B37931-K5103-K60
19	CAP ALU 47uF 100V 20% 8X11.5 105C P=3.5mm T/H	1	C94	Nichicon	UVY2A470MPD1CA
20	CON RJ45 SINGLE 8 POS. SHILDED after vibration	2	CON1, CON2	Bel Stewart	SS71800-007F
21	Terminal block 2 Pole interlocking 3.5mm pitch	1	J1	DECA	MB332-350M02
22	DIODE TVS 58V 40A SRG 400WPK SMA SMT	1	D3	Diodes Inc.	SMAJ58A
23	Diode, Dual Switching BAV99W SOT323	1	D58	Diodes Inc.	BAV99W-7-F
24	DIODE SCHOTTKY 70V 0.2A,225 W, SOD123	1	D55	ON Semiconductor	MMSD701T1G
25	DIODE SCHOTTKY 40V 500mA SOD123 SMT	2	D4,D8	ON Semiconductor	MBR0540T1G
26	IC Prog Shunt Ref 2.5V 2% SOT23-5 SMT	1	D14	TI	TL431CDBVRE4
27	IC, N-CH POWER MOSFET 150v 4.1A SO8	1	Q3	Fairchild	FDS86242
28	1000 BASET SINGLE PORT MAGNETICS SMT	1	J4	BOTHHAND	VP6014 HF
29	Power Inductors 2.2uHy 1.5A 110m Ohm SMT Shielded	1	L4	Coilcraft	LPS3015-222MR
30	INDUCTOR SHIELDED PWR 1UH IRMS=11A SMT	1	L1	Bourns	SRP7030-1R0M
31	Transformer, Gate driver SMT 269uH 0.795 DCR	1	T2	Coilcraft	DA2319-AL
32	TRANS FLYBACK POE+ 38UH SMD PRI RES0.085 ohm	1	T5	WURT ELEKTRON IK	750310742



Microsemi

Item	Description	Qty	Ref Des	Mfr. Name	Mfr. Part Number
33	LED SuperYelGrn 100-130o 20-40mcd h=1 0603 SMD	2	D5, D9	Everlight	19-21-SYGCS530E3TR8
34	IC OPTOISOLATOR MOC217	1	U18	Fairchild	MOC217R2-M
35	PCB Mrk 3.3/5/12V/25W Flyback EVB Drilling Card	1		IQE	PR-1412-D00-IQ
36	RES 75R 125mW 1% 0805 SMT	4	R38-R41	Bourns	CR0805-FX-75R0-E
37	Resistor, 0 Ohm, 5%, 1/16W 0402	2	R1, R9	ASJ	CR10-000ZK
38	RES 0R 250mW 5% 1206 SMT JUMPER<0.05R	2	R126, R128	Samsung	RC3216J000CS
39	RES 442R 250mW 1% 1206 SMT	4	R45, R47-R49	Panasonic	ERJ8ENF4420V
40	RES TK FLM 4.7k 0805	2	R71, R72	Bourns	
41	RES 20 OHM 1/2W 5% 1210 SMT	2	R130, R192	KOA	RK73B2ETTD200J
42	RES TCK FLM 0R 62.5mW 5% 0603 SMT	2	R82, R87	ASJ	CR16-000ZL
43	RES TCK FLM 24.9K 62.5mW 1% 0603 SMT	1	R3	ASJ	CR16-2492FL
44	RES TCK FLM 14.7K 62.5mW 1% 0603 SMT	1	R54	ASJ	CR16-1472FL
45	RES 43.2K 100mW 0603 SMT 1%	1	R34	ASJ	CR16-4322FL
46	Resistor, 18.7K, 1%, 1/16W 0603	1	R81	ASJ	CR16-1872FL
47	Resistor, 3.32K, 1%, 1/16W 0603	1	R77	ASJ	CR16-3321FL
48	Resistor, 30.9R 1%, 1/10W 0603	2	R63, R86	KOA	RK73H1JTDD30R9F
49	RES TCK FLM 5.1K 62.5mW 1% 0603 SMT	1	R55	ASJ	CR16-5101FL
50	RES 562K, 1%, 1/16W, 0603	2	R31, R64	ASJ	CR16-5623FL
51	RES 3.65K 0.1W 1% 0603 SMT MTL FLM	1	R76	ASJ	CR16-3651-FL
52	Resistor, 240K, 1%, 1/10W 0603	1	R2	KOA	RK73H1JTDD2403F
53	Resistor, SMT 56K, 1%, 1/10W 0603	1	R52	KOA	RK73H1JTDD5602F
54	RES TCK FLM 0.18R 0.1W 1% 0603 SMT	2	R44, R51	Bourns	CRL0603-FW-R180ELF
55	RES 4.75R 0.1W 1% 0603 SMT MTL FLM	1	R84	Samsung	RC1608F4R75CS
56	RES 332R 62.5mW 1% 0603 SMT MTL FLM	1	R53	ASJ	CR16-3320FL
57	RES 10K 62.5mW 1% 0603 SMT MTL FLM	3	R36, R73, R129	ASJ	CR16-1002FL
58	RES 1M 62.5mW 1% 0603 SMT MTL FLM	1	R131	ASJ	CR16-1004-FL
59	TRN PNP -30V -1A SOT23	1	Q2	Fairchild	FMMT549
60	N-CH MOSFET 100V 50A 10.2 mΩ TO-252 DPAK SMT	1	Q24	Fairchild	FDD86110



## 11 Board Layout

This paragraph presents the layout of the evaluation board.

The board is a 2-layer board. The layers are 2 Oz layers. The figures below present the two copper layers and the silk of the board for tracking devices placements.

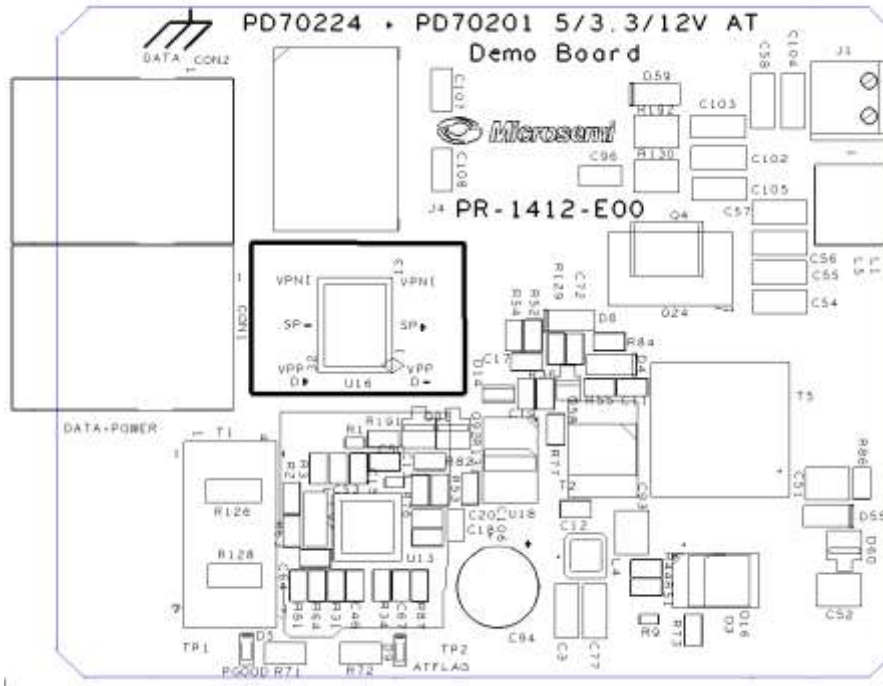

Figure 25: Top Silk

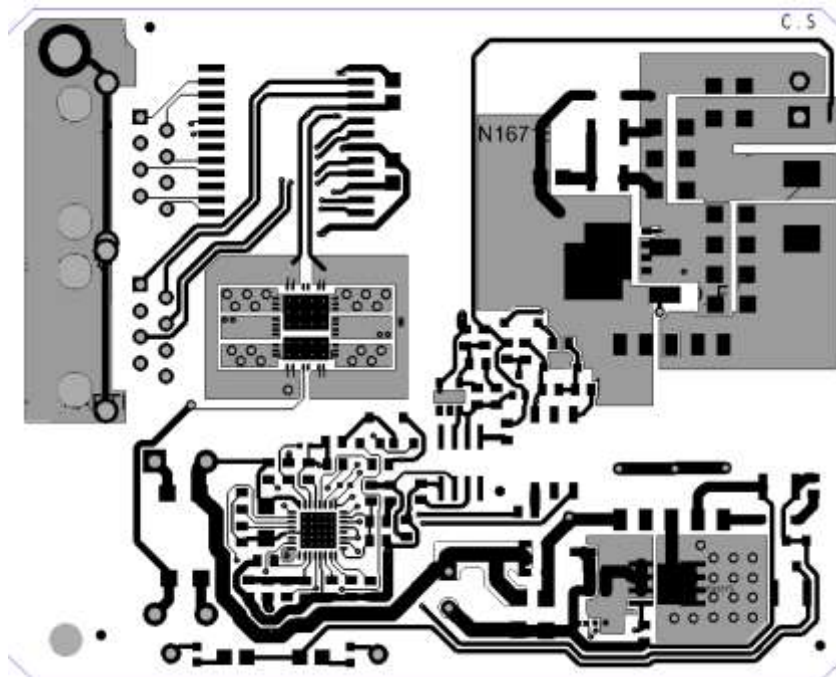
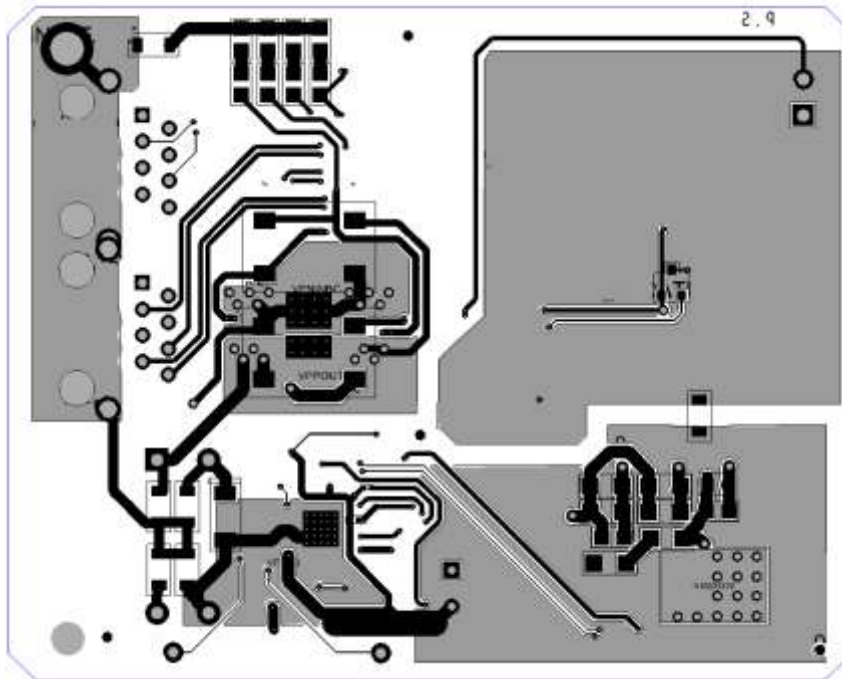
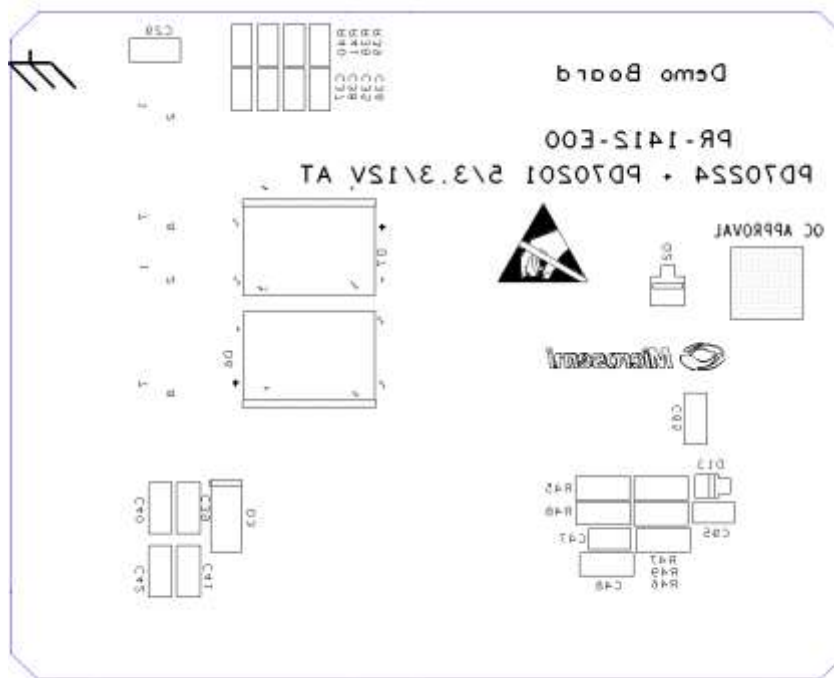

Figure 26: Top Layer





**Figure 27: Bottom Layer**



**Figure 28: Bottom Silk**

*The information contained in the document is PROPRIETARY AND CONFIDENTIAL information of Microsemi and cannot be copied, published, uploaded, posted, transmitted, distributed or disclosed or used without the express duly signed written consent of Microsemi. If the recipient of this document has entered into a disclosure agreement with Microsemi, then the terms of such Agreement will also apply. This document and the information contained herein may not be modified, by any person other than authorized personnel of Microsemi. No license under any patent, copyright, trade secret or other intellectual property right is granted to or conferred upon you by disclosure or delivery of the information, either expressly, by implication, inducement, estoppels or otherwise. Any license under such intellectual property rights must be approved by Microsemi in writing signed by an officer of Microsemi.*

*Microsemi reserves the right to change the configuration, functionality and performance of its products at anytime without any notice. This product has been subject to limited testing and should not be used in conjunction with life-support or other mission-critical equipment or applications. Microsemi assumes no liability whatsoever, and Microsemi disclaims any express or implied warranty, relating to sale and/or use of Microsemi products including liability or warranties relating to fitness for a particular purpose, merchantability, or infringement of any patent, copyright or other intellectual property right. The product is subject to other terms and conditions which can be located on the web at <http://www.microsemi.com/company/terms-and-conditions>.*

**Revision History**

Revision Level / Date	Para. Affected/Page	Description
0.1 / 02-Apr-12		Initial revision
2.0 / 04-Dec-12		Update signal waveforms, efficiency info and board gerbers
2.1 / 07-Jan-15		Update board revision
3.0 / 17-Jan-16		Removed aux connector J2, updated board revision and schematics.
3.1 / 15-Apr-16		Deleted duplicate schematic on page 25

© 2016 Microsemi Corp.

All rights reserved.

For support contact: [PoEsupport@microsemi.com](mailto:PoEsupport@microsemi.com)

Visit our web site at: [www.microsemi.com](http://www.microsemi.com)

**Catalog Number:** PD70201EVB25Fx\_UG

## X-ON Electronics

Largest Supplier of Electrical and Electronic Components

*Click to view similar products for [Ethernet Development Tools](#) category:*

*Click to view products by [Microchip](#) manufacturer:*

Other Similar products are found below :

[KSZ8852HLEYA](#) [TDKEZW5-DEV](#) [XAUI-RISER-B](#) [DP83848H-MAU-EK](#) [ZENETSC0100ZACG](#) [XTIB-E](#) [EVB-LAN9218I-MINI](#)  
[KSZ8081MNX-EVAL](#) [KSZ8081RNB-EVAL](#) [KSZ8091RNB-EVAL](#) [KSZ8852HLE-EVAL](#) [KSZ8863FLL-EVAL](#) [KSZ8873MLL-EVAL](#) [2971](#)  
[TDKEZW3-DEV](#) [PD70201EVB47F](#) [KSZ8895MQX-EVAL](#) [PD70201EVB47](#) [PD-IM-7648M](#) [PD-IM-7648T4](#) [PD-IM-7604-4MH](#)  
[EV09H26A](#) [EV44F42A](#) [PD-IM-7618T4H](#) [PD-IM-7618T4](#) [EVAL-ADIN1300FMCZ](#) [EVAL-ADIN1200FMCZ](#) [KIT-A1006-SHIELD](#)  
[VSC8258EV](#) [VSC8211EV](#) [VSC8584EV](#) [VSC8574EV](#) [EV16T60A](#) [ioShield\\_A](#) [DP83620-EVK/NOPB](#) [STEVAL-TDE001V1](#) [STEVAL-](#)  
[PCC010V1](#) [EVB9512](#) [DP83848T-MAU-EK](#) [DP83848I-POE-EK](#) [DP83848K-MAU-EK](#) [DP83848I-MAU-EK/NOPB](#) [KSZ8041NL-EVAL](#)  
[KSZ8091RNA-EVAL](#) [KSZ8999-EVAL](#) [KSZ8031RNL-EVAL](#) [KSZ8051MLL-EVAL](#) [KSZ8842-16MQL-EVAL](#) [WIZ550S2E-232-EVB](#)  
[ALT4532-EVA-01](#)