



**PICkit™ Serial SPI
Demo Board
User's Guide**

Note the following details of the code protection feature on Microchip devices:

- Microchip products meet the specification contained in their particular Microchip Data Sheet.
- Microchip believes that its family of products is one of the most secure families of its kind on the market today, when used in the intended manner and under normal conditions.
- There are dishonest and possibly illegal methods used to breach the code protection feature. All of these methods, to our knowledge, require using the Microchip products in a manner outside the operating specifications contained in Microchip's Data Sheets. Most likely, the person doing so is engaged in theft of intellectual property.
- Microchip is willing to work with the customer who is concerned about the integrity of their code.
- Neither Microchip nor any other semiconductor manufacturer can guarantee the security of their code. Code protection does not mean that we are guaranteeing the product as "unbreakable."

Code protection is constantly evolving. We at Microchip are committed to continuously improving the code protection features of our products. Attempts to break Microchip's code protection feature may be a violation of the Digital Millennium Copyright Act. If such acts allow unauthorized access to your software or other copyrighted work, you may have a right to sue for relief under that Act.

Information contained in this publication regarding device applications and the like is provided only for your convenience and may be superseded by updates. It is your responsibility to ensure that your application meets with your specifications. MICROCHIP MAKES NO REPRESENTATIONS OR WARRANTIES OF ANY KIND WHETHER EXPRESS OR IMPLIED, WRITTEN OR ORAL, STATUTORY OR OTHERWISE, RELATED TO THE INFORMATION, INCLUDING BUT NOT LIMITED TO ITS CONDITION, QUALITY, PERFORMANCE, MERCHANTABILITY OR FITNESS FOR PURPOSE. Microchip disclaims all liability arising from this information and its use. Use of Microchip devices in life support and/or safety applications is entirely at the buyer's risk, and the buyer agrees to defend, indemnify and hold harmless Microchip from any and all damages, claims, suits, or expenses resulting from such use. No licenses are conveyed, implicitly or otherwise, under any Microchip intellectual property rights.

Trademarks

The Microchip name and logo, the Microchip logo, Accuron, dsPIC, KEELOQ, KEELOQ logo, microID, MPLAB, PIC, PICmicro, PICSTART, PRO MATE, PowerSmart, rfPIC, and SmartShunt are registered trademarks of Microchip Technology Incorporated in the U.S.A. and other countries.

AmpLab, FilterLab, Linear Active Thermistor, Migratable Memory, MXDEV, MXLAB, PS logo, SEEVAL, SmartSensor and The Embedded Control Solutions Company are registered trademarks of Microchip Technology Incorporated in the U.S.A.

Analog-for-the-Digital Age, Application Maestro, CodeGuard, dsPICDEM, dsPICDEM.net, dsPICworks, ECAN, ECONOMONITOR, FanSense, FlexROM, fuzzyLAB, In-Circuit Serial Programming, ICSP, ICEPIC, Mindi, MiWi, MPASM, MPLAB Certified logo, MPLIB, MPLINK, PICkit, PICDEM, PICDEM.net, PICLAB, PICtail, PowerCal, PowerInfo, PowerMate, PowerTool, REAL ICE, rLAB, rfPICDEM, Select Mode, Smart Serial, SmartTel, Total Endurance, UNI/O, WiperLock and ZENA are trademarks of Microchip Technology Incorporated in the U.S.A. and other countries.

SQTP is a service mark of Microchip Technology Incorporated in the U.S.A.

All other trademarks mentioned herein are property of their respective companies.

© 2007, Microchip Technology Incorporated, Printed in the U.S.A., All Rights Reserved.

 Printed on recycled paper.

Microchip received ISO/TS-16949:2002 certification for its worldwide headquarters, design and wafer fabrication facilities in Chandler and Tempe, Arizona, Gresham, Oregon and Mountain View, California. The Company's quality system processes and procedures are for its PIC[®] MCUs and dsPIC[®] DSCs, KEELOQ[®] code hopping devices, Serial EEPROMs, microperipherals, nonvolatile memory and analog products. In addition, Microchip's quality system for the design and manufacture of development systems is ISO 9001:2000 certified.

**QUALITY MANAGEMENT SYSTEM
CERTIFIED BY DNV
== ISO/TS 16949:2002 ==**



PICKit™ SERIAL SPI DEMO BOARD USER'S GUIDE

Table of Contents

Preface	1
Introduction.....	1
Document Layout	1
Conventions Used in this Guide	2
Recommended Reading.....	3
The Microchip Web Site	3
Customer Support	4
Document Revision History	4
Chapter 1. Product Overview	5
1.1 Introduction	5
1.2 Highlights	5
1.3 SPI Serial Communications	6
1.4 What The PICKit™ Serial SPI Demo Board Kit Includes	6
Chapter 2. Installation and Operation	7
2.1 SPI Demo Board Operation	7
2.2 Devices	8
Appendix A. Schematic and Layouts	9
A.1 Introduction	9
A.2 Board - Schematic - Page 1	10
A.3 Board - Schematic - Page 2	11
A.4 Board - Top Silk Layer	12
A.5 Board - Top Layer	12
A.6 Board - Bottom Layer	12
Appendix B. Bill Of Materials (BOM)	13
Worldwide Sales and Service	14

PICKit™ Serial SPI Demo Board User's Guide



PICKit™ SERIAL SPI DEMO BOARD USER'S GUIDE

Preface

NOTICE TO CUSTOMERS

All documentation becomes dated, and this manual is no exception. Microchip tools and documentation are constantly evolving to meet customer needs, so some actual dialogs and/or tool descriptions may differ from those in this document. Please refer to our web site (www.microchip.com) to obtain the latest documentation available.

Documents are identified with a “DS” number. This number is located on the bottom of each page, in front of the page number. The numbering convention for the DS number is “DSXXXXA”, where “XXXX” is the document number and “A” is the revision level of the document.

For the most up-to-date information on development tools, see the MPLAB® IDE on-line help. Select the Help menu, and then Topics to open a list of available on-line help files.

INTRODUCTION

This chapter contains general information that will be useful to know before using the PICKit™ Serial SPI Demo Board. Items discussed in this chapter include:

- Document Layout
- Conventions Used in this Guide
- Recommended Reading
- The Microchip Web Site
- Customer Support
- Document Revision History

DOCUMENT LAYOUT

This document describes how to use the PICKit™ Serial SPI Demo Board as a development tool. The manual layout is as follows:

- **Chapter 1. “Product Overview”** – Important information about the PICKit™ Serial SPI Demo Board.
- **Chapter 2. “Installation and Operation”** – Includes instructions on how to use the PICKit™ Serial SPI Demo Board.
- **Appendix A. “Schematic and Layouts”** – Shows the schematic and layout diagrams for the PICKit™ Serial SPI Demo Board.
- **Appendix B. “Bill Of Materials (BOM)”** – Lists the parts used to build the PICKit™ Serial SPI Demo Board.

PICkit™ Serial SPI Demo Board User's Guide

CONVENTIONS USED IN THIS GUIDE

This manual uses the following documentation conventions:

DOCUMENTATION CONVENTIONS

Description	Represents	Examples
Arial font:		
Italic characters	Referenced books	<i>MPLAB® IDE User's Guide</i>
	Emphasized text	...is the <i>only</i> compiler...
Initial caps	A window	the Output window
	A dialog	the Settings dialog
	A menu selection	select Enable Programmer
Quotes	A field name in a window or dialog	"Save project before build"
Underlined, italic text with right angle bracket	A menu path	<u>File>Save</u>
Bold characters	A dialog button	Click OK
	A tab	Click the Power tab
N'Rnnnn	A number in verilog format, where N is the total number of digits, R is the radix and n is a digit.	4'b0010, 2'hF1
Text in angle brackets < >	A key on the keyboard	Press <Enter>, <F1>
Courier New font:		
Plain Courier New	Sample source code	#define START
	Filenames	autoexec.bat
	File paths	c:\mcc18\h
	Keywords	_asm, _endasm, static
	Command-line options	-Opa+, -Opa-
	Bit values	0, 1
	Constants	0xFF, 'A'
Italic Courier New	A variable argument	<i>file.o</i> , where <i>file</i> can be any valid filename
Square brackets []	Optional arguments	mcc18 [options] <i>file</i> [options]
Curly brackets and pipe character: { }	Choice of mutually exclusive arguments; an OR selection	errorlevel {0 1}
Ellipses...	Replaces repeated text	var_name [, var_name...]
	Represents code supplied by user	void main (void) { ... }

RECOMMENDED READING

This user's guide describes how to use PICkit™ Serial SPI Demo Board. Other useful documents are listed below. The following Microchip documents are available and recommended as supplemental reference resources.

25AA020A/25LC020A Data Sheet, "2K SPI Bus Serial EEPROM" (DS21833)

This data sheet provides detailed information regarding the 25LC020A family.

TC77 Data Sheet, "Thermal Sensor with SPI Interface" (DS20092)

This data sheet provides detailed information regarding the TC77 product.

MCP3201 Data Sheet, "2.7V 12-Bit A/D Converter with SPI Serial Interface" (DS21290)

This data sheet provides detailed information regarding the MCP3201 product.

MCP4821/MCP4822 Data Sheet, "12-Bit DAC with Internal Vref and SPI Interface" (DS21953)

This data sheet provides detailed information regarding the MCP4822 product.

MCP41XXX/42XXX Data Sheet, "Single/Dual Digital Potentiometer with SPI Interface" (DS11195)

This data sheet provides detailed information regarding the MCP41010 product.

MCP6S91/2/3 Data Sheet, "Single Ended, Rail-to-Rail I/O, Low Gain PGA" (DS21908)

This data sheet provides detailed information regarding the MCP6S92 product.

MCP23008/MCP23S08 Data Sheet, "8-Bit I/O Expander with Serial Interface" (DS21919)

This data sheet provides detailed information regarding the MCP23008/MCP23S08 product.

THE MICROCHIP WEB SITE

Microchip provides online support via our web site at www.microchip.com. This web site is used as a means to make files and information easily available to customers. Accessible by using your favorite Internet browser, the web site contains the following information:

- **Product Support** – Data sheets and errata, application notes and sample programs, design resources, user's guides and hardware support documents, latest software releases and archived software
- **General Technical Support** – Frequently Asked Questions (FAQs), technical support requests, online discussion groups, Microchip consultant program member listing
- **Business of Microchip** – Product selector and ordering guides, latest Microchip press releases, listing of seminars and events, listings of Microchip sales offices, distributors and factory representatives

PICkit™ Serial SPI Demo Board User's Guide

CUSTOMER SUPPORT

Users of Microchip products can receive assistance through several channels:

- Distributor or Representative
- Local Sales Office
- Field Application Engineer (FAE)
- Technical Support

Customers should contact their distributor, representative or field application engineer for support. Local sales offices are also available to help customers. A listing of sales offices and locations is included in the back of this document.

Technical support is available through the web site at: <http://support.microchip.com>

DOCUMENT REVISION HISTORY

Revision A (April 2007)

- Initial Release of this Document.

Chapter 1. Product Overview

1.1 INTRODUCTION

The PICKit™ Serial SPI Demo Board demonstrates SPI serial communications and operation of the following devices:

- 25LC020A - 2K SPI Bus Serial EEPROM
- TC77-5.0 - Thermal Sensor with SPI Interface
- MCP3201 - 2.7V 12-Bit A/D Converter with SPI Serial Interface
- MCP4822 - 12-Bit DAC with Internal V_{REF} and SPI Interface
- MCP41010 - Single/Dual Digital Potentiometer with SPI Interface
- MCP6S92 - Single-Ended, Rail-to-Rail I/O, Low-Gain PGA
- MCP23S08 - 8-Bit I/O Expander with Serial Interface

The PICKit™ Serial SPI Demo Board was designed to easily connect to the PICKit Serial Analyzer (DV164122). The PICKit Serial Analyzer provides the SPI master mode serial communications and power. The PICKit™ Serial SPI Demo Board devices all operate in the SPI slave mode and can easily be connected to virtually any demo or development board by connecting the communications lines to connector P1.

1.2 HIGHLIGHTS

This chapter discusses:

- SPI Serial Communications
- SPI Demo Board Operation
- SPI Demo Board Devices

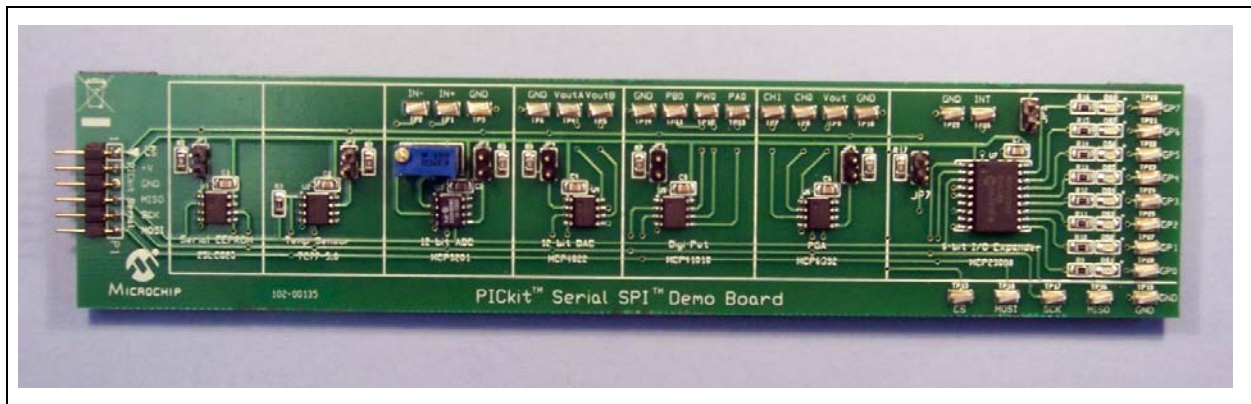

FIGURE 1-1: PICKit™ Serial SPI Demo Board.

PICKit™ Serial SPI Demo Board User's Guide

1.3 SPI SERIAL COMMUNICATIONS

It is assumed that the user is familiar with the SPI protocol. For more information see:

- An SPI tutorial is available on the Microchip Technology website. Click on the links: Support --> Getting Started --> PIC MCU Tutorials --> SPI - PICmicro® Serial Peripheral Interface
- Several application notes are available on the Microchip Technology website. Click on links: Design --> App Notes --> Function: Communications --> SPI

1.4 WHAT THE PICKit™ SERIAL SPI DEMO BOARD KIT INCLUDES

This PICKit™ Serial SPI Demo Board Kit includes:

- PICKit™ Serial SPI Demo Board (102-00135)
- Analog and Interface Products Demonstration Boards CD-ROM (DS21912)
 - PICKit™ Serial SPI Demo Board User's Guide (DS51658)

Chapter 2. Installation and Operation

2.1 SPI DEMO BOARD OPERATION

The PICKit™ Serial SPI Demo Board was designed to easily connect to the PICKit Serial Analyzer (DV164122). Refer to the PICKit Serial Analyzer User's Guide (DS51647) chapter on SPI Master Communications mode for configuration and operation information of the PICKit Serial Analyzer.

The PICKit Serial Analyzer provides the SPI master mode serial communications and power. The PICKit™ Serial SPI Demo Board devices all operate in the SPI slave mode. Figure 2-1 shows the PICKit™ Serial SPI Demo Board block diagram.

The PICKit Serial Analyzer has only one active low chip select (\overline{CS}) line. Individual devices are enabled by inserting the 2-pin shunt onto jumper JP1 through JP7 to connect the CS line to the device. Only one jumper should be inserted at a time.

Note: Only one jumper should be inserted into JP1 through JP7 at a time. Incorrect device operation will occur.

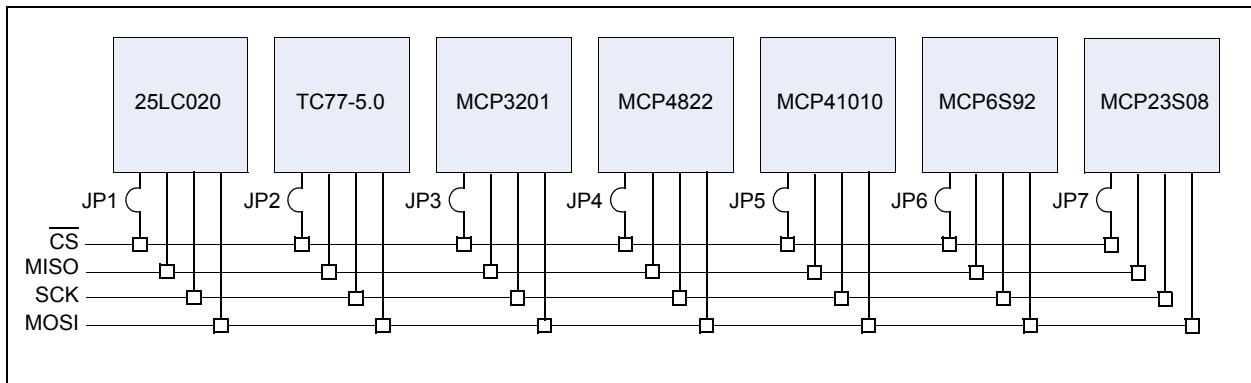

FIGURE 2-1: PICKit™ Serial SPI Demo Board Block Diagram.

Connector P1 connects to the PICKit Serial Analyzer or virtually any demo or development board. Connector P1 pin assignments are listed in Table 2-1.

TABLE 2-1: SPI DEMO BOARD CONNECTOR P1 PIN ASSIGNMENTS

Pin	Label	Type	Description
1	\overline{CS}	Input	Chip Select (Active Low)
2	+V	Power	Power
3	GND	Ground	Ground
4	MISO	Output	Master In, Slave Out
5	SCK	Input	Serial Clock
6	MOSI	Input	Master Out, Slave In

2.2 DEVICES

2.2.1 25LC020A 2K SPI Bus Serial EEPROM

The 25LC020A is a 2Kbit Serial EEPROM. Refer to the 25AA020A/25LC020A Data Sheet (DS21833) for complete information.

Data can be read or written to the 25LC020A.

2.2.2 TC77-5.0 Thermal Sensor with SPI Interface

The TC77 is a serially accessible digital temperature sensor. Refer to the TC77 Data Sheet (DS20092) for complete information.

The temperature can be read from the TC77.

2.2.3 MCP3201 2.7V 12-Bit A/D Converter with SPI Serial Interface

The MCP3201 is a successive approximation 12-bit Analog-to-Digital Converter with on-board sample and hold circuitry. Refer to the MCP3201 Data Sheet (DS21290) for complete information.

The device provides a single pseudo-differential input. Potentiometer R6 is configured as a voltage divider (see schematic in **Appendix A. "Schematic and Layouts"**). The wiper is connected to IN+. The voltage can be read by the MCP3201 by grounding IN- with a test lead and can be verified using a volt meter on test points IN+ and GND.

2.2.4 MCP4822 12-Bit DAC with Internal Vref and SPI Interface

The MCP4822 is a 12-Bit Digital-to-Analog Converter (DAC). Refer to the MCP4821/MCP4822 Data Sheet (DS21953) for complete information.

The output of the MCP4822 can be measured using a volt meter at test points V_{OUTA} , V_{OUTB} , and GND.

2.2.5 MCP41010 Single/Dual Digital Potentiometer with SPI Interface

The MCP41010 is a single 10 k Ω digital potentiometer. Refer to the MCP41XXX/42XXX Data Sheet (DS11195) for complete information.

The resistance of the digital potentiometer can be measured using an ohm meter at test points P_{A0} , P_{W0} , P_{B0} , and GND.

2.2.6 MCP6S92 Single-Ended, Rail-to-Rail I/O, Low-Gain PGA

The MCP6S92 is a single-ended programmable gain amplifier (PGA). Refer to the MCP6S91/2/3 Data Sheet (DS21908) for complete information.

The gain of the PGA can be measured by applying a signal to inputs CH0 or CH1 and GND, and measuring the output on test points Vout and GND.

2.2.7 MCP23S08 8-Bit I/O Expander with Serial Interface

The MCP23008 is an 8-bit I/O Expander. Refer to the MCP23008/MCP23S08 Data Sheet (DS21919) for complete information.

The output of the MCP23S08 drives LEDs DS1 through DS8. The LEDs provide an easy to see indication of the MCP23S08 operation. Jumper JP8 must be closed using a 2-pin shunt for the LEDs to operate. The LEDs can be disabled by removing JP8.

The output of the MCP23S08 is connected to test points GP0 through GP7 and GND. These test points can be monitored by a volt meter or connected to an external device. LEDs DS1 through DS8 can be used to monitor the output by closing JP8 with a 2-pin shunt or disable by removing JP8.



PICKit™ SERIAL SPI DEMO BOARD USER'S GUIDE

Appendix A. Schematic and Layouts

A.1 INTRODUCTION

This appendix contains the following schematics and layouts for the PICKit™ Serial SPI Demo Board User's Guide:

- Board – Schematic - Page 1
- Board – Schematic - Page 2
- Board – Top Silk Layer
- Board – Top Metal Layer
- Board – Bottom Metal Layer

PICkit™ Serial SPI Demo Board User's Guide

A.2 BOARD - SCHEMATIC - PAGE 1

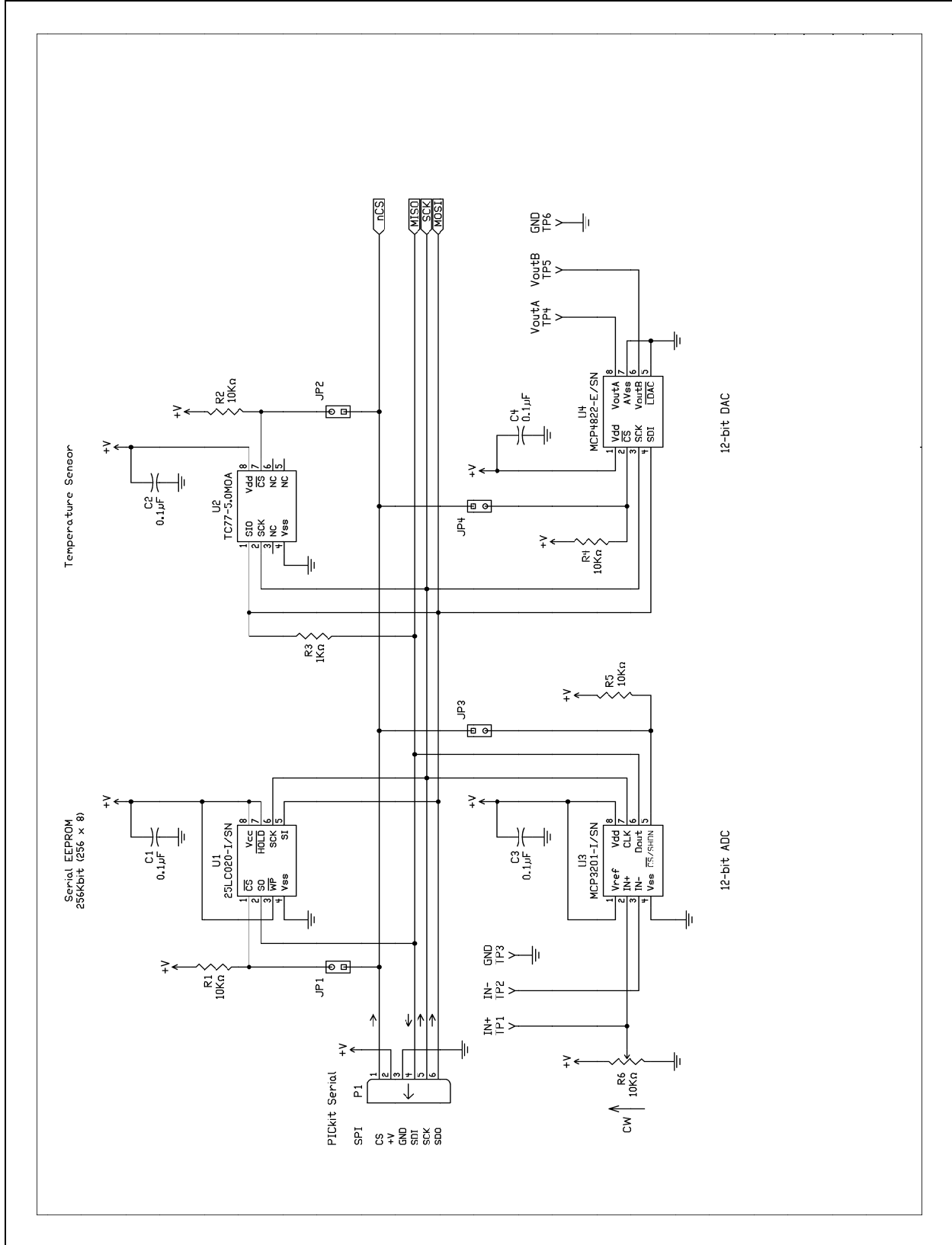

A.3 BOARD - SCHEMATIC - PAGE 2

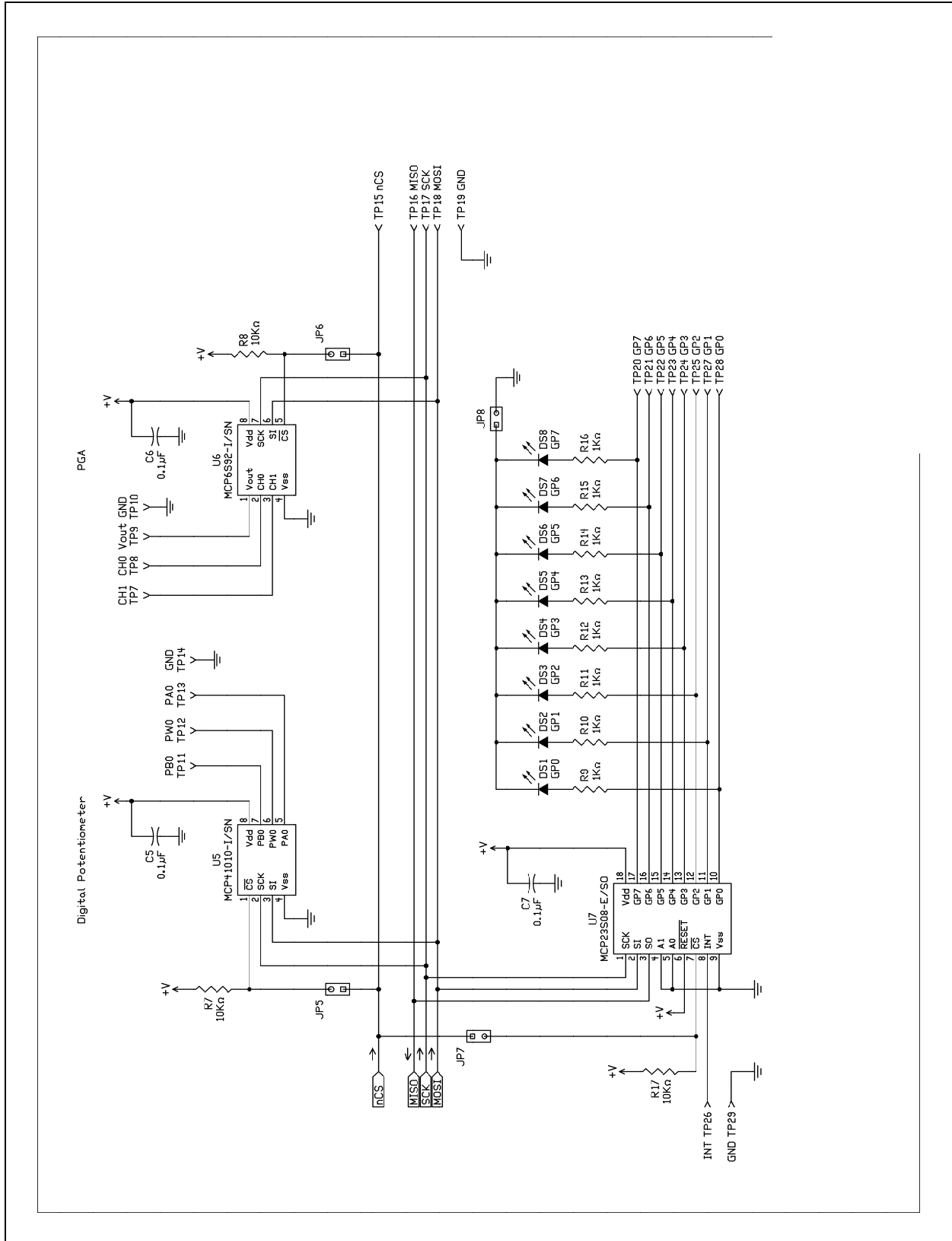

PICKit™ Serial SPI Demo Board User's Guide

A.4 BOARD - TOP SILK LAYER

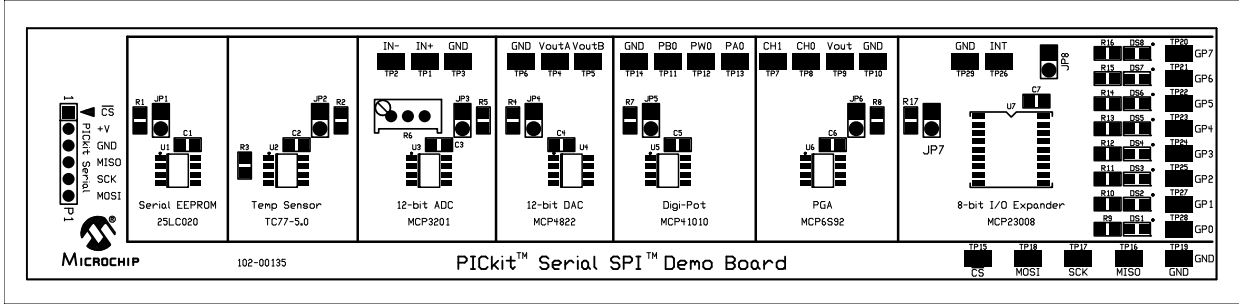

A.5 BOARD - TOP LAYER

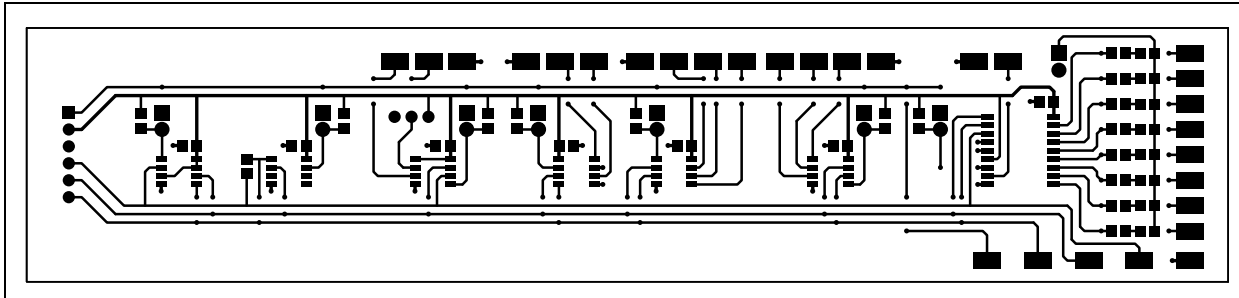

A.6 BOARD - BOTTOM LAYER

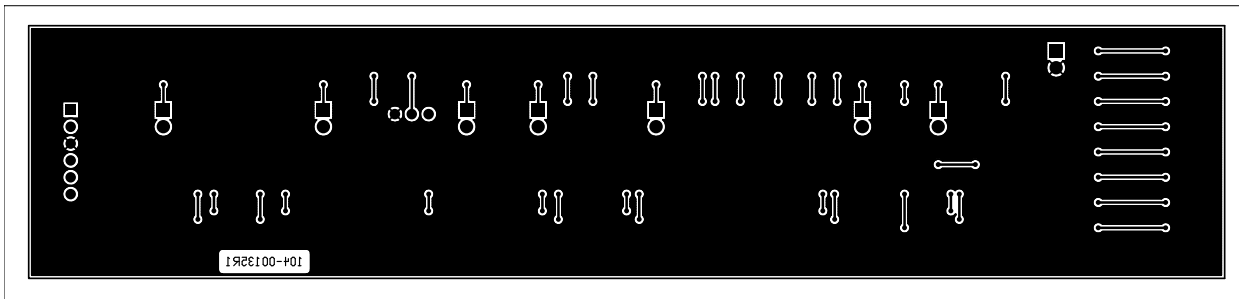

Appendix B. Bill Of Materials (BOM)

TABLE B-1: BILL OF MATERIALS (BOM)

Qty	Reference	Description	Manufacturer	Part Number
7	C1, C2, C3, C4, C5, C6, C7	Capacitor, Ceramic, SMT 0805	Panasonic® - ECG	ECJ-2VB1E104K
8	DS1, DS2, DS3, DS4, DS5, DS6, DS7, DS8	LED RED ORANGE CLEAR 0805 SMD	LITE-ON INC	LTST-C170EKT
4	EA Corner	BUMPON SQUARE .40X.10 BLACK	3M	SJ-5007 (BLACK)
1	JP1	CONN JUMPER SHORTING GOLD FLASH	Sullins Electronics Corp.	SPC02SYAN
8	JP1, JP2, JP3, JP4, JP5, JP6, JP7, JP8	CONN HEADER 2POS .100 VERT TIN	Molex/Waldom Electronics Corp	22-28-4020
1	P1	CONN HEADER 6POS .100 R/A GOLD	Molex/Waldom Electronics Corp	22-28-8062
7	R1, R2, R4, R5, R7, R8, R17	RES 10K OHM 1/8W 5% 0805 SMD	Panasonic - ECG	ERJ-6GEYJ103V
9	R3, R9, R10, R11, R12, R13, R14, R15, R16	RES 1.0K OHM 1/8W 5% 0805 SMD	Panasonic - ECG	ERJ-6GEYJ102V
1	R6	POT 10K OHM 3/8" SQ CERM SL MT	Bourns Inc.	3296W-1-103LF
29	TP1 - TP29	TEST POINT PC COMPACT SMT	Keystone Electronics®	5016
1	U1	2K SPI Bus Serial EEPROM	Microchip Technology	25LC020-I/SN
1	U2	Thermal Sensor with SPI Interface	Microchip Technology	TC77-5.0MOA
1	U3	2.7V 12-Bit A/D Converter with SPI Serial Interface	Microchip Technology	MCP3201-I/SN
1	U4	12 Bit DAC with Internal Vref and SPI Interface	Microchip Technology	MCP4822-E/SN
1	U5	Single/Dual Digital Potentiometer with SPI Interface	Microchip Technology	MCP14010-I/SN
1	U6	Single-Ended, Rail-to-Rail I/O, Low-Gain PGA	Microchip Technology	MCP6S92-I/SN
1	U7	8-Bit I/O Expander with Serial Interface	Microchip Technology	MCP23S08-E/SO

Note 1: The components listed in this Bill of Materials are representative of the PCB assembly. The released BOM used in manufacturing uses all RoHS-compliant components.



WORLDWIDE SALES AND SERVICE

AMERICAS

Corporate Office
2355 West Chandler Blvd.
Chandler, AZ 85224-6199
Tel: 480-792-7200
Fax: 480-792-7277
Technical Support:
<http://support.microchip.com>
Web Address:
www.microchip.com

Atlanta
Duluth, GA
Tel: 678-957-9614
Fax: 678-957-1455

Boston
Westborough, MA
Tel: 774-760-0087
Fax: 774-760-0088

Chicago
Itasca, IL
Tel: 630-285-0071
Fax: 630-285-0075

Dallas
Addison, TX
Tel: 972-818-7423
Fax: 972-818-2924

Detroit
Farmington Hills, MI
Tel: 248-538-2250
Fax: 248-538-2260

Kokomo
Kokomo, IN
Tel: 765-864-8360
Fax: 765-864-8387

Los Angeles
Mission Viejo, CA
Tel: 949-462-9523
Fax: 949-462-9608

Santa Clara
Santa Clara, CA
Tel: 408-961-6444
Fax: 408-961-6445

Toronto
Mississauga, Ontario,
Canada
Tel: 905-673-0699
Fax: 905-673-6509

ASIA/PACIFIC

Asia Pacific Office
Suites 3707-14, 37th Floor
Tower 6, The Gateway
Harbour City, Kowloon
Hong Kong
Tel: 852-2401-1200
Fax: 852-2401-3431

Australia - Sydney
Tel: 61-2-9868-6733
Fax: 61-2-9868-6755

China - Beijing
Tel: 86-10-8528-2100
Fax: 86-10-8528-2104

China - Chengdu
Tel: 86-28-8665-5511
Fax: 86-28-8665-7889

China - Fuzhou
Tel: 86-591-8750-3506
Fax: 86-591-8750-3521

China - Hong Kong SAR
Tel: 852-2401-1200
Fax: 852-2401-3431

China - Qingdao
Tel: 86-532-8502-7355
Fax: 86-532-8502-7205

China - Shanghai
Tel: 86-21-5407-5533
Fax: 86-21-5407-5066

China - Shenyang
Tel: 86-24-2334-2829
Fax: 86-24-2334-2393

China - Shenzhen
Tel: 86-755-8203-2660
Fax: 86-755-8203-1760

China - Shunde
Tel: 86-757-2839-5507
Fax: 86-757-2839-5571

China - Wuhan
Tel: 86-27-5980-5300
Fax: 86-27-5980-5118

China - Xian
Tel: 86-29-8833-7250
Fax: 86-29-8833-7256

ASIA/PACIFIC

India - Bangalore
Tel: 91-80-4182-8400
Fax: 91-80-4182-8422

India - New Delhi
Tel: 91-11-4160-8631
Fax: 91-11-4160-8632

India - Pune
Tel: 91-20-2566-1512
Fax: 91-20-2566-1513

Japan - Yokohama
Tel: 81-45-471- 6166
Fax: 81-45-471-6122

Korea - Gumi
Tel: 82-54-473-4301
Fax: 82-54-473-4302

Korea - Seoul
Tel: 82-2-554-7200
Fax: 82-2-558-5932 or
82-2-558-5934

Malaysia - Penang
Tel: 60-4-646-8870
Fax: 60-4-646-5086

Philippines - Manila
Tel: 63-2-634-9065
Fax: 63-2-634-9069

Singapore
Tel: 65-6334-8870
Fax: 65-6334-8850

Taiwan - Hsin Chu
Tel: 886-3-572-9526
Fax: 886-3-572-6459

Taiwan - Kaohsiung
Tel: 886-7-536-4818
Fax: 886-7-536-4803

Taiwan - Taipei
Tel: 886-2-2500-6610
Fax: 886-2-2508-0102

Thailand - Bangkok
Tel: 66-2-694-1351
Fax: 66-2-694-1350

EUROPE

Austria - Wels
Tel: 43-7242-2244-39
Fax: 43-7242-2244-393

Denmark - Copenhagen
Tel: 45-4450-2828
Fax: 45-4485-2829

France - Paris
Tel: 33-1-69-53-63-20
Fax: 33-1-69-30-90-79

Germany - Munich
Tel: 49-89-627-144-0
Fax: 49-89-627-144-44

Italy - Milan
Tel: 39-0331-742611
Fax: 39-0331-466781

Netherlands - Drunen
Tel: 31-416-690399
Fax: 31-416-690340

Spain - Madrid
Tel: 34-91-708-08-90
Fax: 34-91-708-08-91

UK - Wokingham
Tel: 44-118-921-5869
Fax: 44-118-921-5820

12/08/06

X-ON Electronics

Largest Supplier of Electrical and Electronic Components

Click to view similar products for [Interface Development Tools](#) category:

Click to view products by [Microchip](#) manufacturer:

Other Similar products are found below :

[ADP5585CP-EVALZ](#) [CHA2066-99F](#) [AS8650-DB](#) [MLX80104 TESTINTERFACE](#) [416100120-3](#) [XR18910ILEVB](#) [XR21B1421IL28-0A-EVB](#) [TW-DONGLE-USB](#) [EVAL-ADM2491EEBZ](#) [MAXREFDES23DB#](#) [MAX13235EEVKIT](#) [DFR0257](#) [XR22404CG28EVB](#) [ZLR964122L](#) [ZLR88822L](#) [EVK-U23-01S](#) [EVK-W262U-00](#) [DC327A](#) [PIM511](#) [PIM536](#) [PIM517](#) [DEV-17512](#) [STR-FUSB3307MPX-PPS-GEVK](#) [MAXREFDES177#](#) [EVAL-ADM2567EEBZ](#) [ZSSC3240KIT](#) [MAX9121EVKIT](#) [PIM532](#) [ZSC31010KITV2P1](#) [UMFT4233HPEV](#) [LVDS-18B-EVK](#) [XR20M1170G16-0A-EB](#) [XR20M1170G16-0B-EB](#) [XR20M1170G24-0B-EB](#) [XR20M1172G28-0A-EB](#) [XR20M1172G28-0B-EB](#) [SI871XSOIC8-KIT](#) [1764](#) [1833](#) [1862](#) [EVB-USB82514](#) [ATA6628-EK](#) [ATA6631-EK](#) [EVAL-CN0313-SDPZ](#) [2264](#) [MCP23X17EV](#) [PS081-EVA-HR MODULE](#) [237](#) [SMA2RJ45EVK/NOPB](#) [FR12-0002](#)