



Silicon 2.0 Watt Zener Diodes

DESCRIPTION

The SMB(G/J)5913B – SMB(G/J)5956B series of surface mount 2.0 watt Zener diodes provides a selection from 3.3 to 200 volts with tolerance options of 10%, 5% and 2%. This series has the same electrical characteristics as the axial, JEDEC registered 1N5913 - 1N5956 series with the exception of its higher, 2.0 W power rating (versus 1.5 W for the JEDEC series). This is permitted by the lower thermal resistance of the surface mount packaging. The SMBG Gull-wing design in the DO-215AA package provides for visible solder connections. The SMBJ J-bend design in the DO-214AA package permits greater PC board mounting density. The series is available with SnPb plated leaded or RoHS compliant matte-tin plating.

Important: For the latest information, visit our website <http://www.microsemi.com>.

FEATURES

- Surface mount equivalent to JEDEC registered 1N5913 thru 1N5956 number series but with a 30% higher power rating.
- Ideal for high-density and low-profile mounting.
- Zener voltage available 3.3 V to 200 V.
- Standard voltage tolerances are plus/minus 10%, 5% and 2%.
- RoHS compliant versions available.

APPLICATIONS / BENEFITS

- Regulates voltage over a broad operating current and temperature range.
- Non-sensitive to ESD per MIL-STD-750 method 1020.
- Withstands high surge stresses (see [figure 2](#)).
- Minimal changes of voltage versus current.
- High specified maximum current (I_{ZM}) when adequately heat sunk.
- Moisture classification is Level 1 per IPC/JEDEC J-STD-020B with no dry pack required.

MAXIMUM RATINGS

Parameters/Test Conditions	Symbol	Value	Unit
Junction and Storage Temperature	T_J and T_{STG}	-65 to +150	°C
Thermal Resistance Junction-to-Lead	$R_{\theta JL}$	35	°C/W
Thermal Resistance Junction-to-Ambient ⁽¹⁾	$R_{\theta JA}$	100	°C/W
Steady-State Power Dissipation @ $T_L \leq 80$ °C ⁽²⁾	P_D	2.0	W
Forward Voltage @ 200 mA	V_F	1.2	V
Solder Temperature @ 10 s	T_{SP}	260	°C

Notes: 1. When mounted on FR4 PC board (1oz Cu) with recommended footprint (see [last page](#)).
2. Or 1.25 watts at $T_A = 25$ °C when mounted on FR4 PC board with recommended footprint (also see [figure 1](#).)

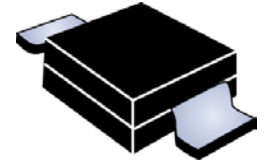

**DO-215AA
Gull-wing Package**

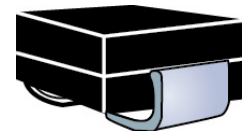

**DO-214AA
J-bend Package**

NOTE: All SMB series are equivalent to prior SMS package identifications.

MSC – Lawrence

6 Lake Street,
Lawrence, MA 01841
Tel: 1-800-446-1158 or
(978) 620-2600
Fax: (978) 689-0803

MSC – Ireland

Gort Road Business Park,
Ennis, Co. Clare, Ireland
Tel: +353 (0) 65 6840044
Fax: +353 (0) 65 6822298

Website:

www.microsemi.com

MECHANICAL and PACKAGING

- CASE: Void-free transfer molded thermosetting epoxy body meeting UL94V-0.
- TERMINALS: Tin-lead or RoHS compliant annealed matte-tin plating solderable per MIL-STD-750, method 2026.
- MARKING: Part number without SMBx prefix (e.g. 5914B, 5914Be3, MX5946C, 5956A, etc.).
- POLARITY: Cathode indicated by band. Diode to be operated with the banded end positive with respect to the opposite end for Zener regulation.
- TAPE & REEL option: Standard per EIA-481-1-A with 12 mm tape (add "TR" suffix to part number). Consult factory for quantities.
- WEIGHT: 0.1 grams.
- See [Package Dimensions](#) on last page.

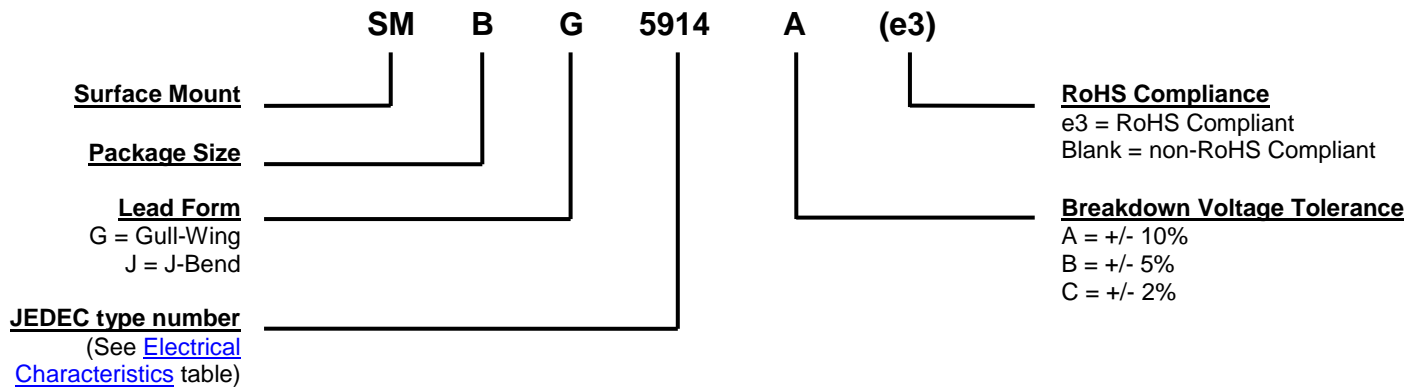
PART NOMENCLATURE

SYMBOLS & DEFINITIONS

Symbol	Definition
I_R	Reverse Current: The maximum reverse (leakage) current that will flow at the specified voltage and temperature.
I_Z, I_{ZT}, I_{ZK}	Regulator Current: The dc regulator current (I_Z), at a specified test point (I_{ZT}), near breakdown knee (I_{ZK}).
I_{ZM}	Maximum Regulator (Zener) Current: The maximum rated dc current for the specified power rating.
V_R	Reverse Voltage: The reverse voltage dc value, no alternating component.
V_Z	Zener Voltage: The Zener voltage the device will exhibit at a specified current (I_Z) in its breakdown region.
Z_{ZT} or Z_{ZK}	Dynamic Impedance: The small signal impedance of the diode when biased to operate in its breakdown region at a specified rms current modulation (typically 10% of I_{ZT} or I_{ZK}) and superimposed on I_{ZT} or I_{ZK} respectively.

ELECTRICAL CHARACTERISTICS @ $T_L = +30\text{ }^\circ\text{C}$

PART NUMBER		ZENER VOLTAGE V_Z	TEST CURRENT I_{ZT}	DYNAMIC IMPEDANCE Z_{ZT}	KNEE CURRENT I_{ZK}	KNEE IMPEDANCE Z_{ZK}	REVERSE CURRENT I_R	REVERSE VOLTAGE V_R	MAX. DC CURRENT I_{ZM}
Gull-Wing	J-Bend	Volts	mA	Ohms	mA	Ohms	μA	Volts	mA
SMBG5913B	SMBJ5913B	3.3	113.6	10.0	1.0	500	100.0	1.0	606
SMBG5914B	SMBJ5914B	3.6	104.2	9.0	1.0	500	75.0	1.0	554
SMBG5915B	SMBJ5915B	3.9	96.1	7.5	1.0	500	25.0	1.0	512
SMBG5916B	SMBJ5916B	4.3	87.2	6.0	1.0	500	10.0	1.0	464
SMBG5917B	SMBJ5917B	4.7	79.8	5.0	1.0	500	5.0	1.5	425
SMBG5918B	SMBJ5918B	5.1	73.5	4.0	1.0	400	5.0	2.0	392
SMBG5919B	SMBJ5919B	5.6	66.9	2.0	1.0	300	5.0	3.0	356
SMBG5920B	SMBJ5920B	6.2	60.5	2.0	1.0	200	5.0	4.0	321
SMBG5921B	SMBJ5921B	6.8	55.1	2.5	1.0	200	5.0	5.2	293
SMBG5922B	SMBJ5922B	7.5	50.0	3.0	0.5	400	5.0	6.0	266
SMBG5923B	SMBJ5923B	8.2	45.7	3.5	0.5	400	5.0	6.5	242
SMBG5924B	SMBJ5924B	9.1	41.2	4.0	0.5	500	5.0	7.0	218
SMBG5925B	SMBJ5925B	10	37.5	4.5	0.25	500	5.0	8.0	200
SMBG5926B	SMBJ5926B	11	34.1	5.5	0.25	550	1.0	8.4	181
SMBG5927B	SMBJ5927B	12	31.2	6.5	0.25	550	1.0	9.1	166
SMBG5928B	SMBJ5928B	13	28.8	7.0	0.25	550	1.0	9.9	153
SMBG5929B	SMBJ5929B	15	25.0	9.0	0.25	600	1.0	11.4	133
SMBG5930B	SMBJ5930B	16	23.4	10.0	0.25	600	1.0	12.2	122
SMBG5931B	SMBJ5931B	18	20.8	12.0	0.25	650	1.0	13.7	110
SMBG5932B	SMBJ5932B	20	18.7	14.0	0.25	650	1.0	15.2	100
SMBG5933B	SMBJ5933B	22	17.0	17.5	0.25	650	1.0	16.7	90
SMBG5934B	SMBJ5934B	24	15.6	19.0	0.25	700	1.0	18.2	82
SMBG5935B	SMBJ5935B	27	13.9	23.0	0.25	700	1.0	20.6	73
SMBG5936B	SMBJ5936B	30	12.5	28.0	0.25	750	1.0	22.8	66
SMBG5937B	SMBJ5937B	33	11.4	33.0	0.25	800	1.0	25.1	60
SMBG5938B	SMBJ5938B	36	10.4	38.0	0.25	850	1.0	27.4	54
SMBG5939B	SMBJ5939B	39	9.6	45.0	0.25	900	1.0	29.7	50
SMBG5940B	SMBJ5940B	43	8.7	53.0	0.25	950	1.0	32.7	45
SMBG5941B	SMBJ5941B	47	8.0	67.0	0.25	1000	1.0	35.8	41
SMBG5942B	SMBJ5942B	51	7.3	70.0	0.25	1100	1.0	38.8	38
SMBG5943B	SMBJ5943B	56	6.7	86.0	0.25	1300	1.0	42.6	34
SMBG5944B	SMBJ5944B	62	6.0	100.0	0.25	1500	1.0	47.1	32
SMBG5945B	SMBJ5945B	68	5.5	120.0	0.25	1700	1.0	51.2	29
SMBG5946B	SMBJ5946B	75	5.0	140.0	0.25	2000	1.0	56.0	26
SMBG5947B	SMBJ5947B	82	4.6	160.0	0.25	2500	1.0	62.2	24
SMBG5948B	SMBJ5948B	91	4.1	200.0	0.25	3000	1.0	69.2	10
SMBG5949B	SMBJ5949B	100	3.7	250.0	0.25	3100	1.0	76.0	20
SMBG5950B	SMBJ5950B	110	3.4	300.0	0.25	4000	1.0	83.6	17
SMBG5951B	SMBJ5951B	120	3.1	380.0	0.25	4500	1.0	91.2	16
SMBG5952B	SMBJ5952B	130	2.9	450.0	0.25	5000	1.0	98.8	14
SMBG5953B	SMBJ5953B	150	2.5	600.0	0.25	6000	1.0	114.0	13
SMBG5954B	SMBJ5954B	160	2.3	700.0	0.25	6500	1.0	121.6	12
SMBG5955B	SMBJ5955B	180	2.1	900.0	0.25	7000	1.0	136.8	10
SMBG5956B	SMBJ5956B	200	1.9	1200.0	0.25	8000	1.0	152.0	9

NOTE 1: Zener voltage (V_Z) is measured at $T_L = 30\text{ }^\circ\text{C}$ and 20 seconds after application of dc current.

NOTE 2: The Zener impedance is derived from 1 kHz ac voltage resulting from an ac current modulation having an rms value equal to 10% of the dc Zener current (I_{ZT} or I_{ZK}) superimposed on I_{ZT} or I_{ZK} . See [MicroNote 202](#) for Zener impedance variation with different operating currents.

NOTE 3: The maximum dc current (I_{ZM}) is based only on the maximum power of 2.0 watts at $T_L \leq 80\text{ }^\circ\text{C}$. These values must be reduced by 37.5% (1.25 W) when mounted on PC boards as described in [maximum ratings](#).

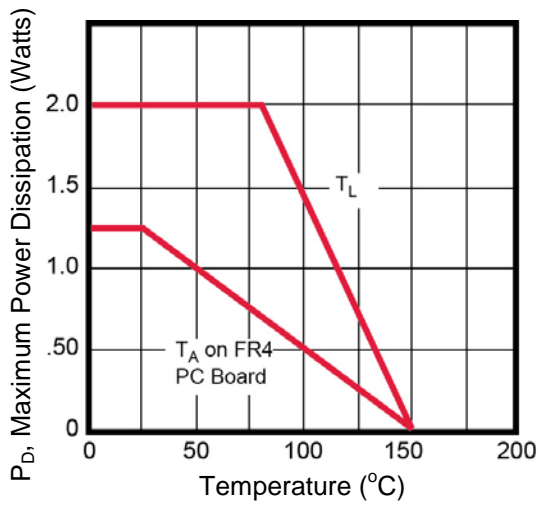
GRAPHS

T_L Lead temp (°C), or T_A on FR4 PC Board

FIGURE 1 – Power Derating Curve

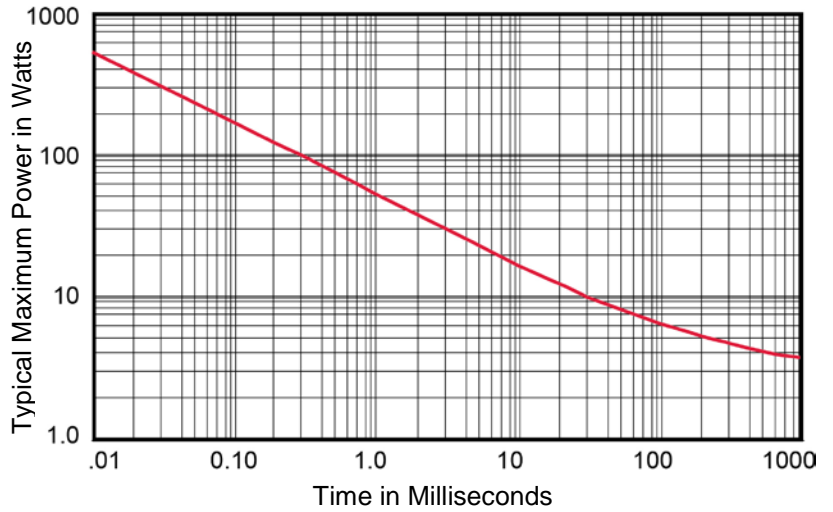

**FIGURE 2 – Transient Surge Capability
Square-Wave Pulse Width
(non-Repetitive) in Milliseconds**

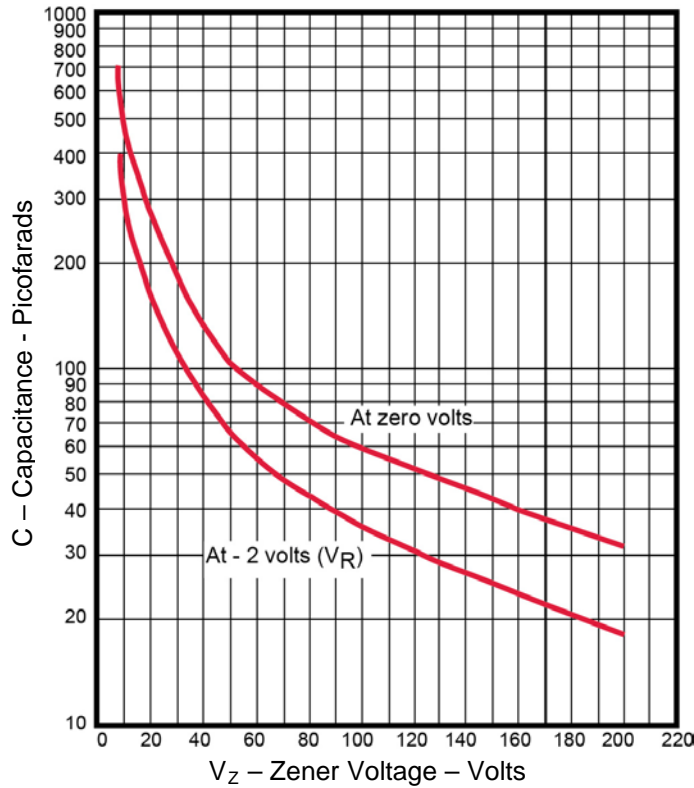
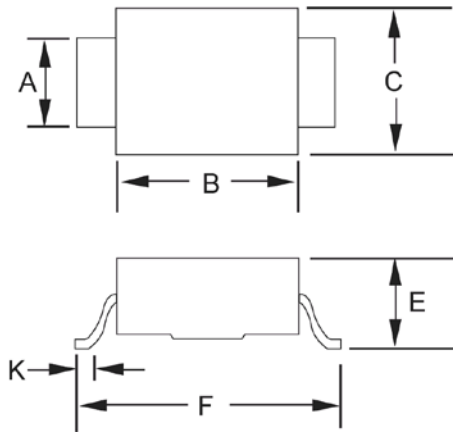
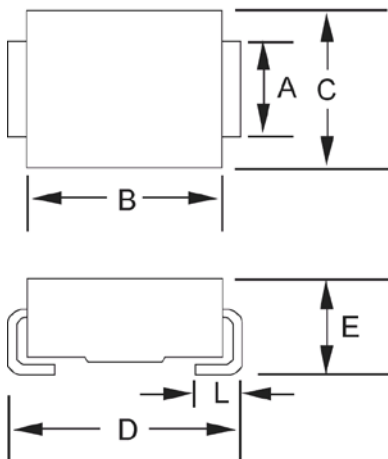

FIGURE 3 – Capacitance vs Zener Voltage

PACKAGE DIMENSIONS

SMBG (DO-215AA)

Ltr	Dimensions			
	Inch		Millimeters	
	Min	Max	Min	Max
A	0.077	0.083	1.96	2.10
B	0.160	0.180	4.06	4.57
C	0.130	0.155	3.30	3.94
E	0.077	0.104	1.95	2.65
F	0.235	0.255	5.97	6.48
K	0.015	0.030	0.381	0.762

SMBJ (DO-214AA)

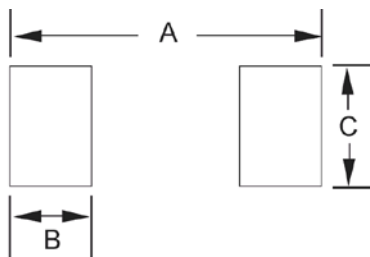
Ltr	Dimensions			
	Inch		Millimeters	
	Min	Max	Min	Max
A	0.077	0.083	1.96	2.10
B	0.160	0.180	4.06	4.57
C	0.130	0.155	3.30	3.94
D	0.205	0.220	5.21	5.59
E	0.077	0.104	1.95	2.65
L	0.030	0.060	0.760	1.52

PAD LAYOUT

SMBG (DO-215AA)		
Ltr	Inch	Millimeters
A	0.320	8.13
B	0.085	2.16
C	0.110	2.79

SMBJ (DO-214AA)		
Ltr	Inch	Millimeters
A	0.260	6.60
B	0.085	2.16
C	0.110	2.79

X-ON Electronics

Largest Supplier of Electrical and Electronic Components

Click to view similar products for [Zener Diodes](#) category:

Click to view products by [Microchip](#) manufacturer:

Other Similar products are found below :

[RKZ13B2KG#P1](#) [RKZ5.6B2KJ#R1](#) [DL5234B](#) [EDZTE6113B](#) [1N4682](#) [1N4691](#) [1N4693](#) [1N4732A](#) [1N4736A](#) [1N4750A](#) [1N4759ARL](#)
[1N5241B](#) [1N5365B](#) [1N5369B](#) [1N747A](#) [1N959B](#) [1N964B](#) [1N966B](#) [1N968B](#) [1N972B](#) [NTE5121A](#) [NTE5147A](#) [NTE5152A](#) [NTE5155A](#)
[NTE5164A](#) [JANS1N4974US](#) [1N4692](#) [1N4700](#) [1N4702](#) [1N4704](#) [1N4711](#) [1N4714](#) [1N4737A](#) [1N4745ARL](#) [1N4752A](#) [1N4752ARL](#)
[1N4760ARL](#) [1N5221B](#) [1N5231B-TR](#) [1N5236B](#) [1N5241BTR](#) [1N5242BTR](#) [1N5350B](#) [1N5352B](#) [1N961BRR1](#) [1N964BRL](#) [RKZ5.1BKU#P6](#)
[3SMAJ5946B-TP](#) [3SMAJ5950B-TP](#) [3SMBJ5925B-TP](#)