



**SOT223-3
Voltage Regulator
Evaluation Board
User's Guide**

Note the following details of the code protection feature on Microchip devices:

- Microchip products meet the specification contained in their particular Microchip Data Sheet.
- Microchip believes that its family of products is one of the most secure families of its kind on the market today, when used in the intended manner and under normal conditions.
- There are dishonest and possibly illegal methods used to breach the code protection feature. All of these methods, to our knowledge, require using the Microchip products in a manner outside the operating specifications contained in Microchip's Data Sheets. Most likely, the person doing so is engaged in theft of intellectual property.
- Microchip is willing to work with the customer who is concerned about the integrity of their code.
- Neither Microchip nor any other semiconductor manufacturer can guarantee the security of their code. Code protection does not mean that we are guaranteeing the product as "unbreakable."

Code protection is constantly evolving. We at Microchip are committed to continuously improving the code protection features of our products. Attempts to break Microchip's code protection feature may be a violation of the Digital Millennium Copyright Act. If such acts allow unauthorized access to your software or other copyrighted work, you may have a right to sue for relief under that Act.

Information contained in this publication regarding device applications and the like is provided only for your convenience and may be superseded by updates. It is your responsibility to ensure that your application meets with your specifications. MICROCHIP MAKES NO REPRESENTATIONS OR WARRANTIES OF ANY KIND WHETHER EXPRESS OR IMPLIED, WRITTEN OR ORAL, STATUTORY OR OTHERWISE, RELATED TO THE INFORMATION, INCLUDING BUT NOT LIMITED TO ITS CONDITION, QUALITY, PERFORMANCE, MERCHANTABILITY OR FITNESS FOR PURPOSE. Microchip disclaims all liability arising from this information and its use. Use of Microchip devices in life support and/or safety applications is entirely at the buyer's risk, and the buyer agrees to defend, indemnify and hold harmless Microchip from any and all damages, claims, suits, or expenses resulting from such use. No licenses are conveyed, implicitly or otherwise, under any Microchip intellectual property rights.

Trademarks

The Microchip name and logo, the Microchip logo, Accuron, dsPIC, KEELOQ, KEELOQ logo, MPLAB, PIC, PICmicro, PICSTART, rPIC, SmartShunt and UNI/O are registered trademarks of Microchip Technology Incorporated in the U.S.A. and other countries.

FilterLab, Linear Active Thermistor, MXDEV, MXLAB, SEEVAL, SmartSensor and The Embedded Control Solutions Company are registered trademarks of Microchip Technology Incorporated in the U.S.A.

Analog-for-the-Digital Age, Application Maestro, CodeGuard, dsPICDEM, dsPICDEM.net, dsPICworks, dsSPEAK, ECAN, ECONOMONITOR, FanSense, In-Circuit Serial Programming, ICSP, ICEPIC, Mindi, MiWi, MPASM, MPLAB Certified logo, MPLIB, MPLINK, mTouch, PICkit, PICDEM, PICDEM.net, PICTail, PIC³² logo, PowerCal, PowerInfo, PowerMate, PowerTool, REAL ICE, rLAB, Select Mode, Total Endurance, WiperLock and ZENA are trademarks of Microchip Technology Incorporated in the U.S.A. and other countries.

SQTP is a service mark of Microchip Technology Incorporated in the U.S.A.

All other trademarks mentioned herein are property of their respective companies.

© 2008, Microchip Technology Incorporated, Printed in the U.S.A., All Rights Reserved.

 Printed on recycled paper.

**QUALITY MANAGEMENT SYSTEM
CERTIFIED BY DNV
== ISO/TS 16949:2002 ==**

Microchip received ISO/TS-16949:2002 certification for its worldwide headquarters, design and wafer fabrication facilities in Chandler and Tempe, Arizona; Gresham, Oregon and design centers in California and India. The Company's quality system processes and procedures are for its PIC[®] MCUs and dsPIC[®] DSCs, KEELOQ[®] code hopping devices, Serial EEPROMs, microperipherals, nonvolatile memory and analog products. In addition, Microchip's quality system for the design and manufacture of development systems is ISO 9001:2000 certified.



MICROCHIP SOT223-3 VOLTAGE REGULATOR EVALUATION BOARD USER'S GUIDE

Table of Contents

Preface	1
Introduction.....	1
Document Layout	1
Conventions Used in this Guide	2
Recommended Reading.....	3
The Microchip Web Site	3
Customer Support	3
Document Revision History	3
 Chapter 1. Product Overview	
1.1 Introduction	5
1.2 What is the SOT223-3 Voltage Regulator Evaluation Board?	5
1.3 What the SOT223-3 Voltage Regulator Evaluation Board kit includes?	6
 Chapter 2. Installation and Operation	
2.1 Introduction	7
2.2 Features	7
2.3 Getting Started	7
 Appendix A. Schematic and Layouts	
A.1 Introduction	9
A.2 Board - Schematic	10
A.3 Board - Top Copper Layout	11
A.4 Board - Bottom Copper Layout	12
A.5 Board - Top Silk Layout	13
 Appendix B. Bill of Materials (BOM)	
 Worldwide Sales and Service	16

SOT223-3 Voltage Regulator Evaluation Board User's Guide

NOTES:



SOT223-3 VOLTAGE REGULATOR EVALUATION BOARD USER'S GUIDE

Preface

NOTICE TO CUSTOMERS

All documentation becomes dated, and this manual is no exception. Microchip tools and documentation are constantly evolving to meet customer needs, so some actual dialogs and/or tool descriptions may differ from those in this document. Please refer to our web site (www.microchip.com) to obtain the latest documentation available.

Documents are identified with a "DS" number. This number is located on the bottom of each page, in front of the page number. The numbering convention for the DS number is "DSXXXXA", where "XXXX" is the document number and "A" is the revision level of the document.

For the most up-to-date information on development tools, see the MPLAB® IDE on-line help. Select the Help menu, and then Topics to open a list of available on-line help files.

INTRODUCTION

This chapter contains general information that will be useful to know before using the SOT223-3 Voltage Regulator Evaluation Board. Items discussed in this chapter include:

- Document Layout
- Conventions Used in this Guide
- Recommended Reading
- The Microchip Web Site
- Customer Support
- Document Revision History

DOCUMENT LAYOUT

This document describes how to use the SOT223-3 Voltage Regulator Evaluation Board as a development tool to emulate and debug firmware on a target board. The manual layout is as follows:

- **Chapter 1. "Product Overview"** – Important information about the SOT223-3 Voltage Regulator Evaluation Board.
- **Chapter 2. "Installation and Operation"** – Includes instructions on how to get started with this evaluation board and a description of the evaluation board operation.
- **Appendix A. "Schematic and Layouts"** – Shows the schematic and layout diagrams for the SOT223-3 Voltage Regulator Evaluation Board.
- **Appendix B. "Bill of Materials (BOM)"** – Lists the parts used to build the SOT223-3 Voltage Regulator Evaluation Board.

SOT223-3 Voltage Regulator Evaluation Board User's Guide

CONVENTIONS USED IN THIS GUIDE

This manual uses the following documentation conventions:

DOCUMENTATION CONVENTIONS

Description	Represents	Examples
Arial font:		
Italic characters	Referenced books	<i>MPLAB® IDE User's Guide</i>
	Emphasized text	...is the <i>only</i> compiler...
Initial caps	A window	the Output window
	A dialog	the Settings dialog
	A menu selection	select Enable Programmer
Quotes	A field name in a window or dialog	"Save project before build"
Underlined, italic text with right angle bracket	A menu path	<u>File>Save</u>
Bold characters	A dialog button	Click OK
	A tab	Click the Power tab
N'Rnnnn	A number in verilog format, where N is the total number of digits, R is the radix and n is a digit.	4'b0010, 2'hF1
Text in angle brackets < >	A key on the keyboard	Press <Enter>, <F1>
Courier New font:		
Plain Courier New	Sample source code	#define START
	Filenames	autoexec.bat
	File paths	c:\mcc18\h
	Keywords	_asm, _endasm, static
	Command-line options	-Opa+, -Opa-
	Bit values	0, 1
	Constants	0xFF, 'A'
Italic Courier New	A variable argument	<i>file.o</i> , where <i>file</i> can be any valid filename
Square brackets []	Optional arguments	mcc18 [options] <i>file</i> [options]
Curly brackets and pipe character: { }	Choice of mutually exclusive arguments; an OR selection	errorlevel {0 1}
Ellipses...	Replaces repeated text	var_name [, var_name...]
	Represents code supplied by user	void main (void) { ... }

RECOMMENDED READING

This user's guide describes how to use SOT223-3 Voltage Regulator Evaluation Board. Other useful documents are listed below. The following Microchip documents are available and recommended as supplemental reference resources.

- **MCP1790 Data Sheet, “70 mA, High Voltage Regulator” (DS-22075)**
- **MCP1824 Data Sheet, “300 mA, Low Voltage, Low Quiescent Current LDO Regulator” (DS-22070)**
- **MCP1825 Data Sheet, “500 mA, Low Voltage, Low Quiescent Current LDO Regulator” (DS-22056)**
- **MCP1826 Data Sheet, “1000 mA, Low Voltage, Low Quiescent Current LDO Regulator” (DS-22057)**

These datasheets provide useful information regarding voltage regulator parameters that may be validated using this evaluation board.

THE MICROCHIP WEB SITE

Microchip provides online support via our web site at www.microchip.com. This web site is used as a means to make files and information easily available to customers. Accessible by using your favorite Internet browser, the web site contains the following information:

- **Product Support** – Data sheets and errata, application notes and sample programs, design resources, user's guides and hardware support documents, latest software releases and archived software
- **General Technical Support** – Frequently Asked Questions (FAQs), technical support requests, online discussion groups, Microchip consultant program member listing
- **Business of Microchip** – Product selector and ordering guides, latest Microchip press releases, listing of seminars and events, listings of Microchip sales offices, distributors and factory representatives

CUSTOMER SUPPORT

Users of Microchip products can receive assistance through several channels:

- Distributor or Representative
- Local Sales Office
- Field Application Engineer (FAE)
- Technical Support

Customers should contact their distributor, representative or field application engineer (FAE) for support. Local sales offices are also available to help customers. A listing of sales offices and locations is included in the back of this document.

Technical support is available through the web site at: <http://support.microchip.com>

DOCUMENT REVISION HISTORY

Revision A (November 2008)

- Initial Release of this Document.

SOT223-3 Voltage Regulator Evaluation Board User's Guide

NOTES:



SOT223-3 VOLTAGE REGULATOR EVALUATION BOARD USER'S GUIDE

Chapter 1. Product Overview

1.1 INTRODUCTION

The SOT223-3 Voltage Regulator Evaluation Board is designed to provide functional evaluation of Microchip Voltage Regulators that utilize the SOT223-3 package and the following device pinout:

- Pin 1 = V_{IN}
- Pin 2 = GND
- Pin 3 = V_{OUT}

The SOT223-3 Voltage Regulator Evaluation Board does not come with a voltage regulator soldered onto the board. This allows the user to attach the voltage regulator of their choosing to the board and perform quiescent current, ground current, PSRR, and other desired tests.

The SOT223-3 Voltage Regulator Evaluation Board is based upon a modular concept which will allow the user to plug in additional boards to increase the test capability of the voltage regulator. Planned additional modular plugin boards currently consist of an Input Voltage Linestep Board, Output Voltage Loadstep Board, and several other device packages.

1.2 WHAT IS THE SOT223-3 VOLTAGE REGULATOR EVALUATION BOARD?

The SOT223-3 Voltage Regulator Evaluation Board is designed to evaluate and test voltage regulators. By soldering the desired device to the evaluation board, the user can easily validate several parameters of the device.

1.2.1 Functional Blocks

The SOT223-3 Voltage Regulator Evaluation Board can be broken up into 3 functional blocks. These blocks are as follows:

- Input Capacitance
- Ground Current Measurement
- Load Resistor

1.2.2 Input Capacitance

Jumper JP1 connects the input capacitance to the circuit. The input capacitor is disconnected when performing Power Supply Ripple Rejection tests. By default, C1 is populated with a 1 μ F, 50V, XR7 ceramic capacitor.

1.2.3 Ground Current Measurement

Jumper JP3 allows measurement of ground current. When a current meter is connected to TP6 and TP7 and jumper JP3 is removed, the ground current of the device may be measured.

SOT223-3 Voltage Regulator Evaluation Board User's Guide

1.2.4 Load Resistor

R5 and R6 may be populated with the desired load resistor values for the device being evaluated. JP4 connects R5 to the device output, JP5 connects R6 to the device output.

1.2.5 Output Capacitor

C2 may be populated with the desired surface mount output capacitance. By default, C2 is populated with a 1 μ F, 6.3V, XR7 ceramic capacitor.

C3 may be populated with an electrolytic or tantalum capacitor having a radial lead spacing of 0.100".

1.2.6 Power Supply

J1 or TP1 and TP2 are connected to the user's power supply.

1.3 WHAT THE SOT223-3 VOLTAGE REGULATOR EVALUATION BOARD KIT INCLUDES?

This SOT223-3 Voltage Regulator Evaluation Board kit includes:

- SOT223-3 Voltage Regulator Evaluation Board (102-00199)
- Analog and Interface Products Demonstration Boards CD-ROM includes:
 - SOT223-3 Voltage Regulator Evaluation Board User's Guide (DS51779)

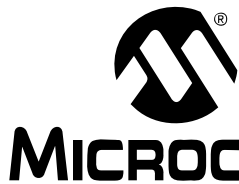

SOT223-3 VOLTAGE REGULATOR EVALUATION BOARD USER'S GUIDE

Chapter 2. Installation and Operation

2.1 INTRODUCTION

The SOT223-3 Voltage Regulator Evaluation Board is designed to facilitate evaluation of Microchip's voltage regulators or to be used as a stand-alone voltage regulator board. Jumpers have been placed on the board to ease the test of the specific voltage regulator parameters.

The SOT223-3 Voltage Regulator Evaluation Board kit comes with a 1 μ F ceramic input and output capacitor soldered to the board. The board has two unpopulated resistor locations that may be used for loads.

2.2 FEATURES

The SOT223-3 Voltage Regulator Evaluation Board has the following features:

- Input and Output headers for future connection to Line Step and Load Step modules
- Ample testpoints to attach multimeters, power supplies, and loads
- Jumper to select ground current measurement
- Jumper to select two different load resistors
- Jumper to connect input capacitor to circuit

2.3 GETTING STARTED

The SOT223-3 Voltage Regulator Evaluation Board is fully assembled and tested. For operating, a user supplied voltage regulator and a supply voltage source are required. Some of the tests that may be completed using the SOT223-3 Voltage Regulator Evaluation Board are described in the next subchapters.

2.3.1 Ground Current and Quiescent Current

When measuring ground current, jumper JP3 should be removed, otherwise leave jumper JP3 on. To measure ground current, perform the following steps:

1. Add desired load resistors to R5 and R6.
2. Remove jumpers JP3, JP4, and JP5.
3. Connect an ammeter across testpoints TP6(+) and TP7(-). Select the appropriate meter scale for the device that is being evaluated.
4. Connect a voltmeter across testpoints TP9(+) and TP10(-).
5. Add jumper JP1.
6. Apply source voltage to testpoints TP1(+) and TP2(-).
7. Verify that the voltage across testpoints TP9 and TP10 is within the expected range of the tested device.
8. Read the Ground Current directly from the ammeter connected to the testpoints TP6 and TP7.
9. Vary the input voltage to obtain data for ground current versus input voltage. If no load is attached to the output of the voltage regulator, the measured "ground current" is also called the "quiescent current" of the regulator.

10. Add a load selection jumper, JP4 or JP5.
11. Read the Ground Current directly from the ammeter connected to the testpoints TP6 and TP7.
12. The data collected will be the "ground current" versus load current.

2.3.2 Load Resistance

R5 and R6 are used to set the desired load values. One choice is to set R5 to the minimum current wanted for testing. R6 would then be set to a value appropriate for the specific tests. Either value may be selected by adding their respective jumpers.

2.3.3 Line Step

Dynamic Line Step response may be evaluated by connecting an electronically switched input voltage to testpoints TP1(+) and TP2(-) or to connector J1. An oscilloscope is connected to TP3 (Ch1 Trigger), TP9 (Ch2) and TP10 (Gnd). An appropriate load is selected using R5 and JP4 or R6 and JP5. The input voltage is then electronically switched from a low voltage to a higher one. The corresponding voltage waveform data of the voltage regulator response is captured by the oscilloscope. Microchip will be offering a Line Step module that connects directly to connector J1. The Line Step module will be capable of switching between two voltage levels that the user supplies.

2.3.4 Load Step

Dynamic Load Step response may be evaluated by connecting an electronically switched load to testpoints TP9(+) and TP10(-), or to connector P1. An oscilloscope is connected to the electronic load switch signal (Ch1 Trigger), to TP9 (Ch2) and TP10(Gnd). The load is then electronically switched from a high resistance to a low resistance. The corresponding voltage waveform data of the voltage regulator response is captured by the oscilloscope. Microchip will be offering a Load Step module that connects directly to connector P1. The Load Step module has several selectable load values populated on board to cover a wide range of loads. The load has the ability to be electronically or manually switched.

2.3.5 Power Supply Rejection Ratio (PSRR)

Power Supply Rejection Ratio tests are performed by removing the input capacitor jumper, JP1, and connecting an appropriate PSRR analyzer to the SOT223-3 Voltage Regulator Evaluation Board. The PSRR analyzer may then sweep the input voltage frequencies and record the corresponding output voltages.

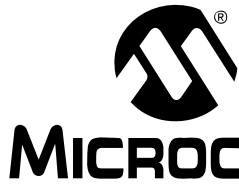

SOT223-3 VOLTAGE REGULATOR EVALUATION BOARD USER'S GUIDE

Appendix A. Schematic and Layouts

A.1 INTRODUCTION

This appendix contains the following schematics and layouts for the SOT223-3 Voltage Regulator Evaluation Board:

- Board - Schematic
- Board - Top Copper Layout
- Board - Bottom Copper Layout
- Board - Top Silk Layout

SOT223-3 Voltage Regulator Evaluation Board User's Guide

A.2 BOARD - SCHEMATIC

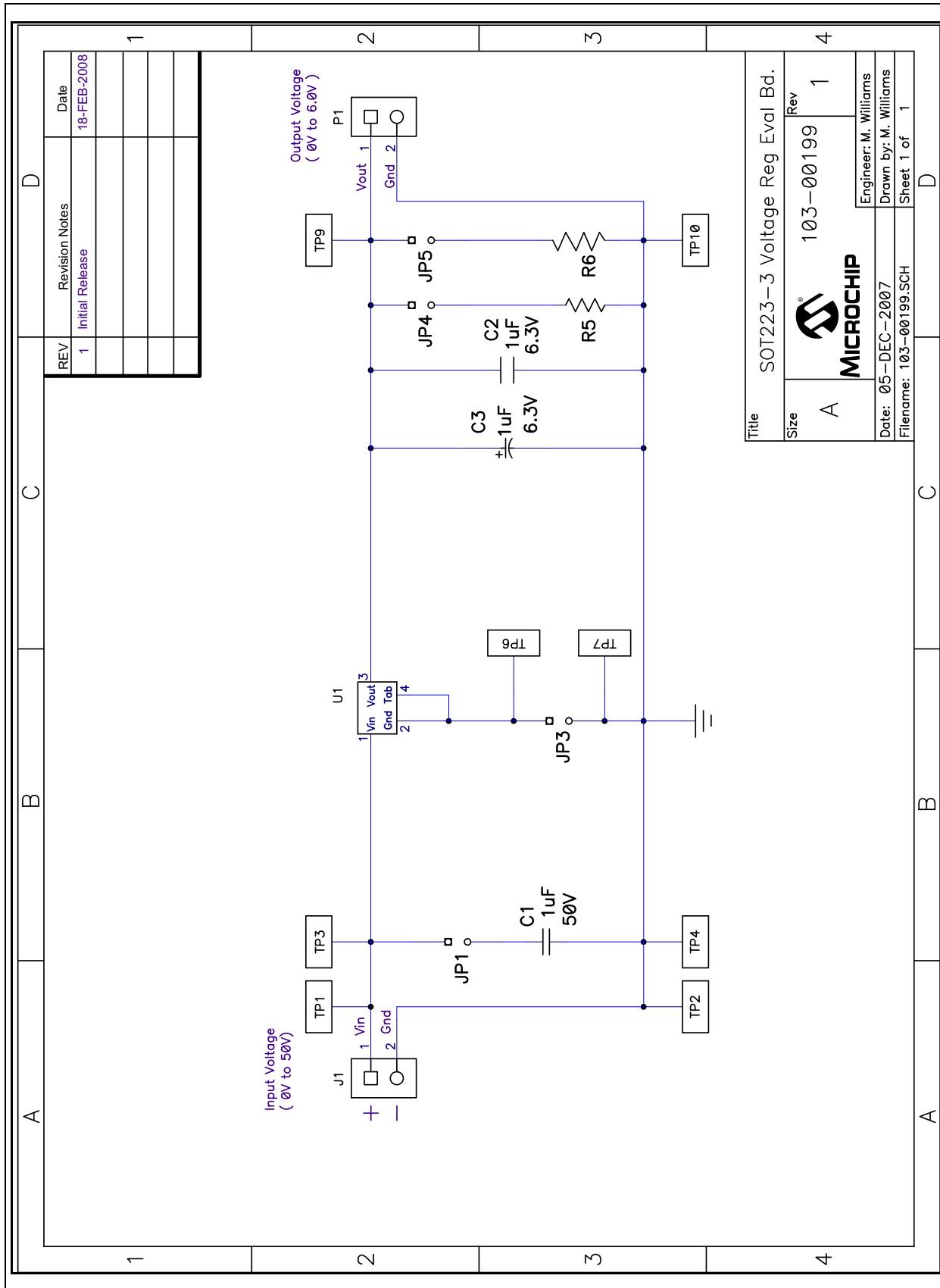

A.3 BOARD - TOP COPPER LAYOUT

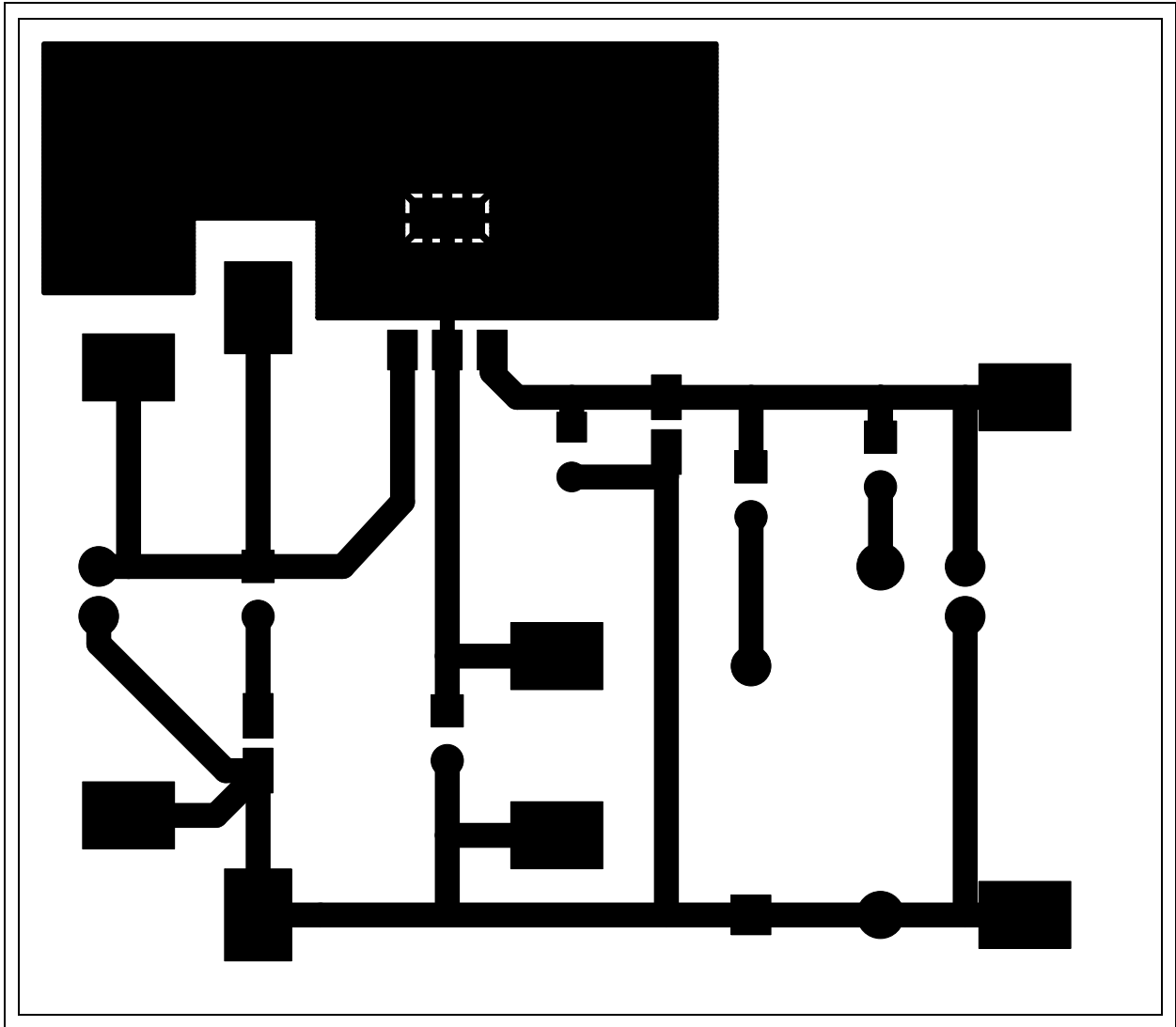

SOT223-3 Voltage Regulator Evaluation Board User's Guide

A.4 BOARD - BOTTOM COPPER LAYOUT

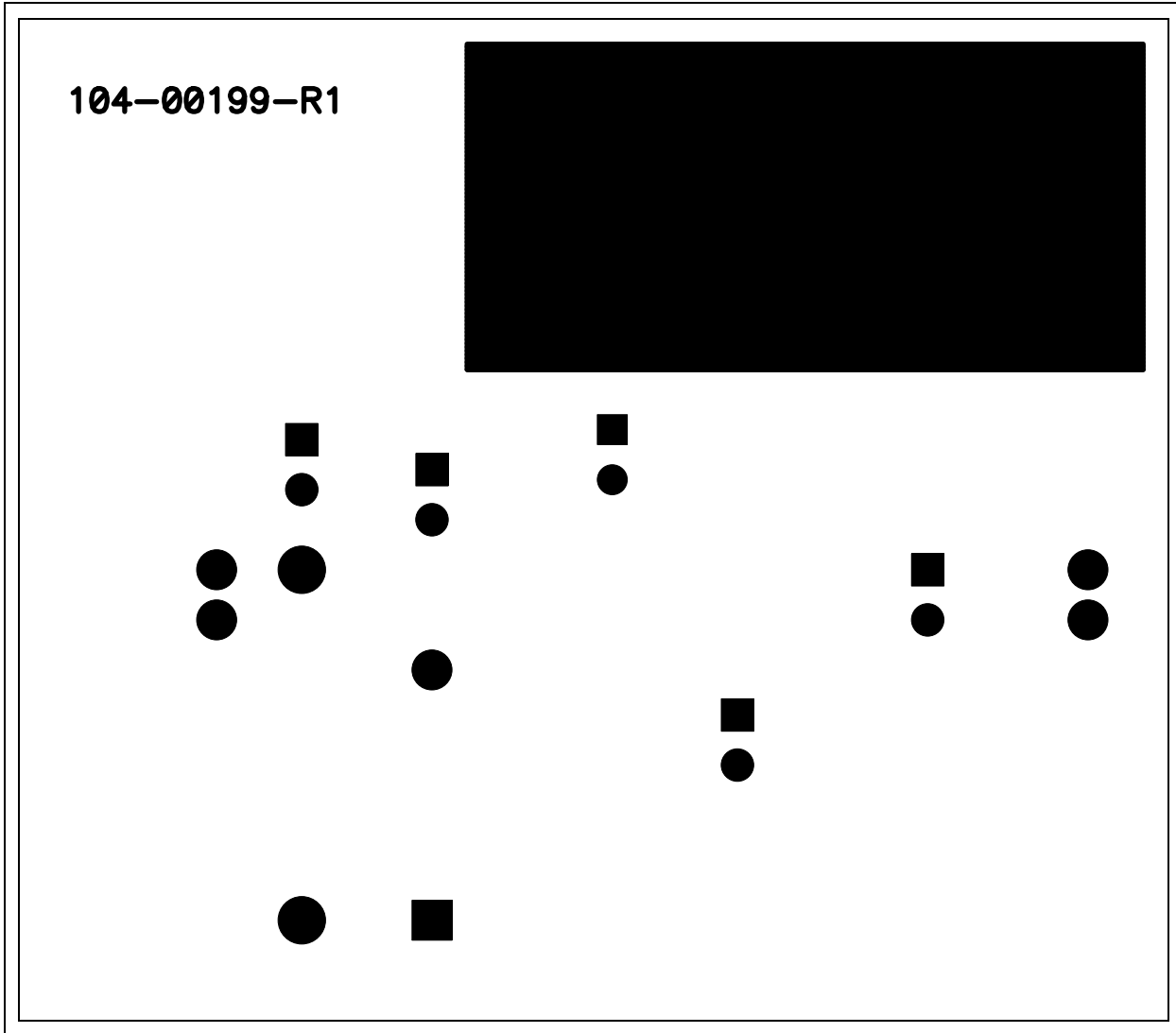

A.5 BOARD - TOP SILK LAYOUT

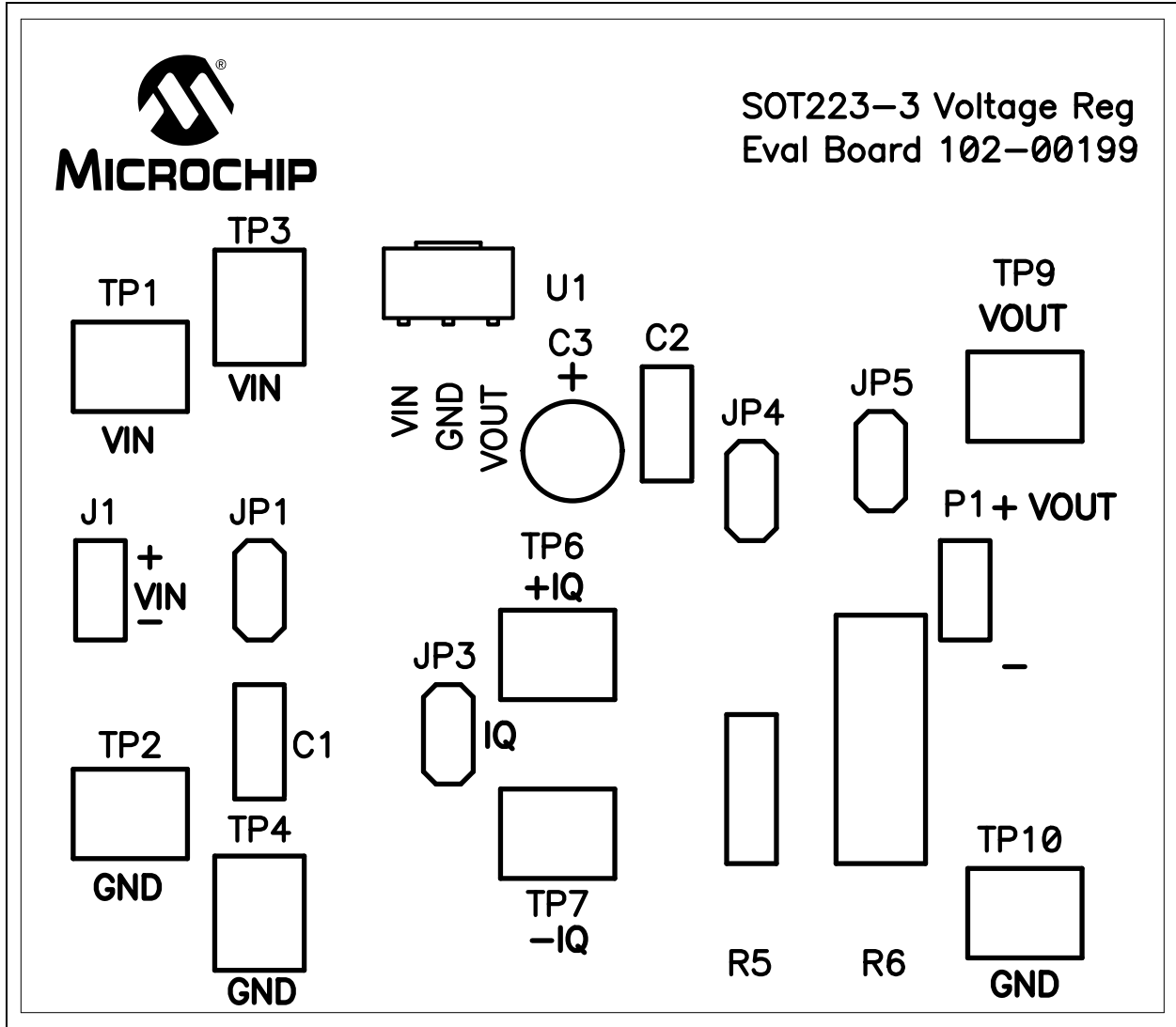

SOT223-3 Voltage Regulator Evaluation Board User's Guide

NOTES:

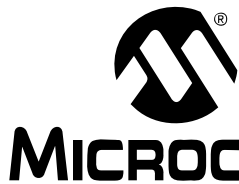

SOT223-3 VOLTAGE REGULATOR EVALUATION BOARD USER'S GUIDE

Appendix B. Bill of Materials (BOM)

TABLE B-1: BILL OF MATERIALS (BOM)

Qty	Reference	Description	Manufacturer	Part Number
1	C1	CAP CERAMIC 1.0 μ F 50V X7R 0805	Murata Electronics®	GRM21BR71H105KA12L
1	C2	CAP CERAMIC 1.0 μ F 16V X7R 0805	Kemet® Electronics Corp.	C0805C105K4RACTU
1	C3	DO NOT POPULATE	–	–
1	J1	2 pin RA header, 0.100 centers, 0.025 sq pins, 0.070 pcb to pin center height, 36 pins to a strip (yields 18 headers)	3M	929835-01-36-RK
4	JP1, JP3, JP4, JP5	2 pin header, 0.100 centers, 0.025 sq pins, 0.070 pcb to pin center height, 36 pins to a strip (yields 18 headers)	Molex® Electronics	22-28-4360
4	JP1, JP3, JP4, JP5	Connector, Shorting jumper, Tin, 0.100"	Sullins	STC02SYAN
1	P1	RA socket, 0.100 centers, 0.025 sq pins, 0.070 pcb to pin center height	Sullins	PPPC021LGBN-RC
2	PCB	RoHS Compliant Bare PCB, SOT223-3 Voltage Regulator Eval Board	Microchip Technology Inc.	104-00199
2	R5, R6	DO NOT POPULATE	–	–
8	TP1, TP2, TP3, TP4, TP6, TP7, TP9, TP10	SMT Testpoint	Keystone Electronics®	5016
1	U1	DO NOT POPULATE	–	–
4	Each Corner	Bumpon Hemisphere 0.44 x 0.20 Clear	3M	SJ-5303 (Clear)

Note 1: The components listed in this Bill of Materials are representative of the PCB assembly. The released BOM used in manufacturing uses all RoHS-compliant components.



WORLDWIDE SALES AND SERVICE

AMERICAS

Corporate Office
2355 West Chandler Blvd.
Chandler, AZ 85224-6199
Tel: 480-792-7200
Fax: 480-792-7277
Technical Support:
<http://support.microchip.com>
Web Address:
www.microchip.com

Atlanta
Duluth, GA
Tel: 678-957-9614
Fax: 678-957-1455

Boston
Westborough, MA
Tel: 774-760-0087
Fax: 774-760-0088

Chicago
Itasca, IL
Tel: 630-285-0071
Fax: 630-285-0075

Dallas
Addison, TX
Tel: 972-818-7423
Fax: 972-818-2924

Detroit
Farmington Hills, MI
Tel: 248-538-2250
Fax: 248-538-2260

Kokomo
Kokomo, IN
Tel: 765-864-8360
Fax: 765-864-8387

Los Angeles
Mission Viejo, CA
Tel: 949-462-9523
Fax: 949-462-9608

Santa Clara
Santa Clara, CA
Tel: 408-961-6444
Fax: 408-961-6445

Toronto
Mississauga, Ontario,
Canada
Tel: 905-673-0699
Fax: 905-673-6509

ASIA/PACIFIC

Asia Pacific Office
Suites 3707-14, 37th Floor
Tower 6, The Gateway
Harbour City, Kowloon
Hong Kong
Tel: 852-2401-1200
Fax: 852-2401-3431

Australia - Sydney
Tel: 61-2-9868-6733
Fax: 61-2-9868-6755

China - Beijing
Tel: 86-10-8528-2100
Fax: 86-10-8528-2104

China - Chengdu
Tel: 86-28-8665-5511
Fax: 86-28-8665-7889

China - Hong Kong SAR
Tel: 852-2401-1200
Fax: 852-2401-3431

China - Nanjing
Tel: 86-25-8473-2460
Fax: 86-25-8473-2470

China - Qingdao
Tel: 86-532-8502-7355
Fax: 86-532-8502-7205

China - Shanghai
Tel: 86-21-5407-5533
Fax: 86-21-5407-5066

China - Shenyang
Tel: 86-24-2334-2829
Fax: 86-24-2334-2393

China - Shenzhen
Tel: 86-755-8203-2660
Fax: 86-755-8203-1760

China - Wuhan
Tel: 86-27-5980-5300
Fax: 86-27-5980-5118

China - Xiamen
Tel: 86-592-2388138
Fax: 86-592-2388130

China - Xian
Tel: 86-29-8833-7252
Fax: 86-29-8833-7256

China - Zhuhai
Tel: 86-756-3210040
Fax: 86-756-3210049

ASIA/PACIFIC

India - Bangalore
Tel: 91-80-4182-8400
Fax: 91-80-4182-8422

India - New Delhi
Tel: 91-11-4160-8631
Fax: 91-11-4160-8632

India - Pune
Tel: 91-20-2566-1512
Fax: 91-20-2566-1513

Japan - Yokohama
Tel: 81-45-471- 6166
Fax: 81-45-471-6122

Korea - Daegu
Tel: 82-53-744-4301
Fax: 82-53-744-4302

Korea - Seoul
Tel: 82-2-554-7200
Fax: 82-2-558-5932 or
82-2-558-5934

Malaysia - Kuala Lumpur
Tel: 60-3-6201-9857
Fax: 60-3-6201-9859

Malaysia - Penang
Tel: 60-4-227-8870
Fax: 60-4-227-4068

Philippines - Manila
Tel: 63-2-634-9065
Fax: 63-2-634-9069

Singapore
Tel: 65-6334-8870
Fax: 65-6334-8850

Taiwan - Hsin Chu
Tel: 886-3-572-9526
Fax: 886-3-572-6459

Taiwan - Kaohsiung
Tel: 886-7-536-4818
Fax: 886-7-536-4803

Taiwan - Taipei
Tel: 886-2-2500-6610
Fax: 886-2-2508-0102

Thailand - Bangkok
Tel: 66-2-694-1351
Fax: 66-2-694-1350

EUROPE

Austria - Wels
Tel: 43-7242-2244-39
Fax: 43-7242-2244-393

Denmark - Copenhagen
Tel: 45-4450-2828
Fax: 45-4485-2829

France - Paris
Tel: 33-1-69-53-63-20
Fax: 33-1-69-30-90-79

Germany - Munich
Tel: 49-89-627-144-0
Fax: 49-89-627-144-44

Italy - Milan
Tel: 39-0331-742611
Fax: 39-0331-466781

Netherlands - Drunen
Tel: 31-416-690399
Fax: 31-416-690340

Spain - Madrid
Tel: 34-91-708-08-90
Fax: 34-91-708-08-91

UK - Wokingham
Tel: 44-118-921-5869
Fax: 44-118-921-5820

X-ON Electronics

Largest Supplier of Electrical and Electronic Components

Click to view similar products for [Power Management IC Development Tools](#) category:

Click to view products by [Microchip](#) manufacturer:

Other Similar products are found below :

[EVB-EP5348UI](#) [MIC23451-AAAYFL EV](#) [MIC5281YMME EV](#) [124352-HMC860LP3E](#) [DA9063-EVAL](#) [ADP122-3.3-EVALZ](#) [ADP130-0.8-EVALZ](#) [ADP130-1.8-EVALZ](#) [ADP1740-1.5-EVALZ](#) [ADP1870-0.3-EVALZ](#) [ADP1874-0.3-EVALZ](#) [ADP199CB-EVALZ](#) [ADP2102-1.25-EVALZ](#) [ADP2102-1.875EVALZ](#) [ADP2102-1.8-EVALZ](#) [ADP2102-2-EVALZ](#) [ADP2102-3-EVALZ](#) [ADP2102-4-EVALZ](#) [AS3606-DB](#) [BQ25010EVM](#) [BQ3055EVM](#) [ISLUSBI2CKIT1Z](#) [LP38512TS-1.8EV](#) [EVAL-ADM1186-1MBZ](#) [EVAL-ADM1186-2MBZ](#) [ADP122UJZ-REDYKIT](#) [ADP166Z-REDYKIT](#) [ADP170-1.8-EVALZ](#) [ADP171-EVALZ](#) [ADP1853-EVALZ](#) [ADP1873-0.3-EVALZ](#) [ADP198CP-EVALZ](#) [ADP2102-1.0-EVALZ](#) [ADP2102-1-EVALZ](#) [ADP2107-1.8-EVALZ](#) [ADP5020CP-EVALZ](#) [CC-ACC-DBMX-51](#) [ATPL230A-EK](#) [MIC23250-S4YMT EV](#) [MIC26603YJL EV](#) [MIC33050-SYHL EV](#) [TPS60100EVM-131](#) [TPS65010EVM-230](#) [TPS71933-28EVM-213](#) [TPS72728YFFEVM-407](#) [TPS79318YEQEVM](#) [UCC28810EVM-002](#) [XILINXPWR-083](#) [LMR22007YMINI-EVM](#) [LP38501ATJ-EV](#)