

## 50 mA, 100 mA, and 150 mA CMOS LDOs with Shutdown and Error Output

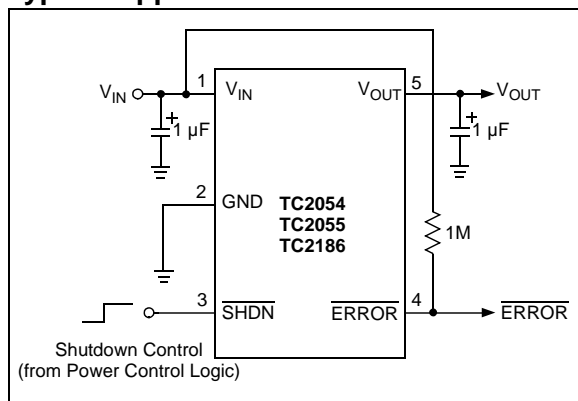
### Features

- Low Supply Current (55  $\mu$ A Typical) for Longer Battery Life
- Low Dropout Voltage: 140 mV (Typical) @ 150 mA
- High Output Voltage Accuracy:  $\pm 0.4\%$  (Typical)
- Standard or Custom Output Voltages
- Power-Saving Shutdown Mode
- $\overline{\text{ERROR}}$  Output Can Be Used as a Low Battery Detector or Processor Reset Generator
- Fast Shutdown Reponse Time: 60  $\mu$ s (Typical)
- Overcurrent and Overtemperature Protection
- Space-Saving 5-Pin SOT-23A Package
- Pin Compatible Upgrades for Bipolar Regulators
- Standard Output Voltage Options:
  - 1.8V, 2.5V, 2.6V, 2.7V, 2.8V, 2.85V, 3.0V, 3.3V, 5.0V

### Applications

- Battery Operated Systems
- Portable Computers
- Medical Instruments
- Instrumentation
- Cellular / GSMS / PHS Phones
- Pagers

### Typical Application



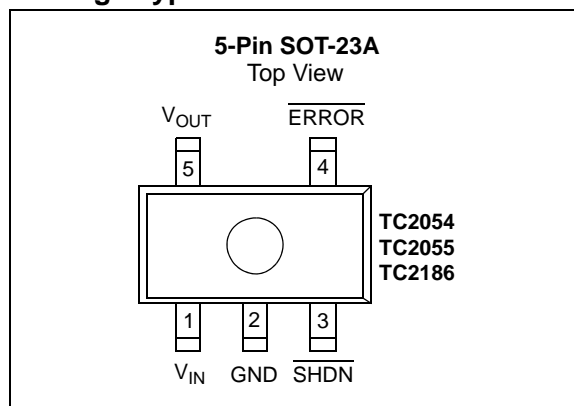
### General Description

The TC2054, TC2055 and TC2186 are high accuracy (typically  $\pm 0.4\%$ ) CMOS upgrades for older (bipolar) low dropout regulators. Designed specifically for battery-operated systems, the devices' total supply current is typically 55  $\mu$ A at full load (20 to 60 times lower than in bipolar regulators).

The devices' key features include low noise operation, low dropout voltage – typically 45 mV (TC2054); 90 mV (TC2055); and 140 mV (TC2186) at full load - and fast response to step changes in load. An error output ( $\overline{\text{ERROR}}$ ) is asserted when the devices are out-of-regulation (due to a low input voltage or excessive output current). Supply current is reduced to 0.5  $\mu$ A (maximum) and both  $V_{OUT}$  and  $\overline{\text{ERROR}}$  are disabled when the shutdown input is low. The devices also incorporate overcurrent and overtemperature protection.

The TC2054, TC2055 and TC2186 are stable with a low esr ceramic output capacitor of 1  $\mu$ F and have a maximum output current of 50 mA, 100 mA and 150 mA, respectively. This LDO Family also features a fast response time (60  $\mu$ s typically) when released from shutdown.

### Package Type



NOTES:

## 1.0 ELECTRICAL CHARACTERISTICS

### Absolute Maximum Ratings †

|                                  |                                   |
|----------------------------------|-----------------------------------|
| Input Voltage .....              | 6.5V                              |
| Output Voltage .....             | (-0.3) to (V <sub>IN</sub> + 0.3) |
| Operating Temperature .....      | -40°C < T <sub>J</sub> < 125°C    |
| Storage Temperature .....        | -65°C to +150°C                   |
| Maximum Voltage on Any Pin ..... | V <sub>IN</sub> + 0.3V to -0.3V   |

† **Notice:** Stresses above those listed under “Absolute Maximum Ratings” may cause permanent damage to the device. These are stress ratings only and functional operation of the device at these or any other conditions above those indicated in the operation sections of the specifications is not implied. Exposure to Absolute Maximum Rating conditions for extended periods may affect device reliability.

### ELECTRICAL SPECIFICATIONS

**Electrical Specifications:** Unless otherwise noted, V<sub>IN</sub> = V<sub>R</sub> + 1V, I<sub>L</sub> = 100 μA, C<sub>L</sub> = 3.3 μF,  $\overline{\text{SHDN}} > V_{\text{IH}}$ , T<sub>A</sub> = +25°C. **BOLDFACE** type specifications apply for junction temperature of -40°C to +125°C.

| Parameter                                | Sym  | Min                   | Typ                   | Max                   | Units  | Conditions  |
|--|--|-----------------------|-----------------------|-----------------------|--------|---|
| Input Operating Voltage                  | V <sub>IN</sub>                                      | 2.7                   | —                     | 6.0                   | V      | <b>Note 1</b>   |
| Maximum Output Current                   | I <sub>OUTMAX</sub>                                  | 50                    | —                     | —                     | mA     | TC2054  |
|  |  | 100                   | —                     | —                     |        | TC2055  |
|  |  | 150                   | —                     | —                     |        | TC2186  |
| Output Voltage                           | V <sub>OUT</sub>                                     | V <sub>R</sub> - 2.0% | V <sub>R</sub> ± 0.4% | V <sub>R</sub> + 2.0% | V      | <b>Note 2</b>   |
| V <sub>OUT</sub> Temperature Coefficient | TCV <sub>OUT</sub>                                   | —                     | 20                    | —                     | ppm/°C | <b>Note 3</b>   |
|  |  | —                     | 40                    | —                     |        |   |
| Line Regulation                          | $\frac{\Delta V_{\text{OUT}}}{\Delta V_{\text{IN}}}$ | —                     | 0.05                  | 0.5                   | %      | (V <sub>R</sub> + 1V) ≤ V <sub>IN</sub> ≤ 6V                  |
| Load Regulation                          | $\frac{\Delta V_{\text{OUT}}}{V_{\text{OUT}}}$       | -1.0                  | 0.33                  | +1.0                  | %      | TC2054; TC2055 I <sub>L</sub> = 0.1 mA to I <sub>OUTMAX</sub> |
|  |  | -2.0                  | 0.43                  | +2.0                  |        | TC2186 I <sub>L</sub> = 0.1 mA to I <sub>OUTMAX</sub>         |
|  |  | <b>Note 6</b>         |                       |                       |        |   |
| Dropout Voltage, <b>Note 7</b>           | V <sub>IN</sub> - V <sub>OUT</sub>                   | —                     | 2                     | —                     | mV     | I <sub>L</sub> = 100 μA                                       |
|  |  | —                     | 45                    | 70                    |        | I <sub>L</sub> = 50 mA  |
|  |  | —                     | 90                    | 140                   |        | TC2015; TC2185 I <sub>L</sub> = 100 mA                        |
|  |  | —                     | 140                   | 210                   |        | TC2185 I <sub>L</sub> = 150 mA                                |
|  |  | <b>Note 7</b>         |                       |                       |        |   |
| Supply Current                           | I <sub>IN</sub>                                      | —                     | 55                    | 80                    | μA     | $\overline{\text{SHDN}} = V_{\text{IH}}$ , I <sub>L</sub> = 0 |
| Shutdown Supply Current                  | I <sub>INSD</sub>                                    | —                     | 0.05                  | 0.5                   | μA     | $\overline{\text{SHDN}} = 0\text{V}$                          |
| Power Supply Rejection Ratio             | PSRR   | —                     | 50                    | —                     | dB     | F <sub>RE</sub> ≤ 100 kHz                                     |
| Output Short Circuit Current             | I <sub>OUTSC</sub>                                   | 160                   | 300                   | —                     | mA     | V <sub>OUT</sub> = 0V   |

- Note 1:** The minimum V<sub>IN</sub> has to meet two conditions: V<sub>IN</sub> = 2.7V and V<sub>IN</sub> = V<sub>R</sub> + V<sub>DROPOUT</sub>.
- 2:** V<sub>R</sub> is the regulator output voltage setting. For example: V<sub>R</sub> = 1.8V, 2.7V, 2.8V, 2.85V, 3.0V, 3.3V.
- 3:** TCV<sub>OUT</sub> =  $\frac{(V_{\text{OUTMAX}} - V_{\text{OUTMIN}}) \times 10^6}{V_{\text{OUT}} \times \Delta T}$
- 4:**
- 5:**
- 6:** Regulation is measured at a constant junction temperature using low duty cycle pulse testing. Load regulation is tested over a load range from 1.0 mA to the maximum specified output current. Changes in output voltage due to heating effects are covered by the thermal regulation specification.
- 7:** Dropout voltage is defined as the input to output differential at which the output voltage drops 2% below its nominal value at a 1V differential.
- 8:** Thermal Regulation is defined as the change in output voltage at a time T after a change in power dissipation is applied, excluding load or line regulation effects. Specifications are for a current pulse equal to I<sub>MAX</sub> at V<sub>IN</sub> = 6V for T = 10 ms.
- 9:** The maximum allowable power dissipation is a function of ambient temperature, the maximum allowable junction temperature and the thermal resistance from junction-to-air (i.e. T<sub>A</sub>, T<sub>J</sub>, θ<sub>JA</sub>).
- 10:** Hysteresis voltage is referenced by V<sub>R</sub>.
- 11:** Time required for V<sub>OUT</sub> to reach 95% of V<sub>R</sub> (output voltage setting), after V<sub>SHDN</sub> is switched from 0 to V<sub>IN</sub>.

# TC2054/2055/2186

## ELECTRICAL SPECIFICATIONS (CONTINUED)

| <b>Electrical Specifications:</b> Unless otherwise noted, $V_{IN} = V_R + 1V$ , $I_L = 100 \mu A$ , $C_L = 3.3 \mu F$ , $\overline{SHDN} > V_{IH}$ , $T_A = +25^\circ C$ .<br><b>BOLDFACE</b> type specifications apply for junction temperature of $-40^\circ C$ to $+125^\circ C$ . |                             |     |                   |     |                 |   |
|---|-----------------------------|-----|-------------------|-----|-----------------|---|
| Parameter   | Sym                         | Min | Typ               | Max | Units           | Conditions  |
| Thermal Regulation  | $\Delta V_{OUT}/\Delta P_D$ | —   | 0.04              | —   | V/W             | <b>Note 8</b>   |
| Thermal Shutdown Die Temperature  | $T_{SD}$                    | —   | 160               | —   | $^\circ C$      |   |
| Output Noise  | eN                          | —   | 600               | —   | nV/ $\sqrt{Hz}$ | $I_L = I_{OUTMAX}$ , $F = 10 \text{ kHz}$   |
| Response Time (from Shutdown Mode)  | $t_R$                       | —   | 60                | —   | $\mu s$         | $V_{IN} = 4V$<br>$C_{IN} = 1 \mu F$ , $C_{OUT} = 10 \mu F$<br>$I_L = 0.1 \text{ mA}$ , <b>Note 11</b> |
| <b>SHDN Input</b>   |                             |     |                   |     |                 |   |
| SHDN Input High Threshold   | $V_{IH}$                    | 60  | —                 | —   | % $V_{IN}$      | $V_{IN} = 2.5V$ to $6.0V$   |
| SHDN Input Low Threshold  | $V_{IL}$                    | —   | —                 | 15  | % $V_{IN}$      | $V_{IN} = 2.5V$ to $6.0V$   |
| <b>ERROR OUTPUT</b>   |                             |     |                   |     |                 |   |
| Minimum $V_{IN}$ Operating Voltage  | $V_{INMIN}$                 | 1.0 | —                 | —   | V               | $I_{OL} = 0.1 \text{ mA}$   |
| Output Logic Low Voltage  | $V_{OL}$                    | —   | —                 | 400 | mV              | 1 mA Flows to $\overline{ERROR}$ ,<br>$I_{OL} = 1 \text{ mA}$ , $V_{IN} = 2V$                         |
| ERROR Threshold Voltage   | $V_{TH}$                    | —   | $0.95 \times V_R$ | —   | V               | See <a href="#">Figure 4-2</a>  |
| ERROR Positive Hysteresis   | $V_{HYS}$                   | —   | 50                | —   | mV              | <b>Note 10</b>  |
| $V_{OUT}$ to $\overline{ERROR}$ Delay   | $t_{DELAY}$                 | —   | 2                 | —   | ms              | $V_{OUT}$ from $V_R = 3V$ to $2.8V$   |
| Resistance from $\overline{ERROR}$ to GND   | $R_{ERROR}$                 | —   | 126               | —   | $\Omega$        | $V_{DD} = 2.5V$ , $V_{OUT} = 2.5V$  |

- Note 1:** The minimum  $V_{IN}$  has to meet two conditions:  $V_{IN} = 2.7V$  and  $V_{IN} = V_R + V_{DROPOUT}$ .
- 2:**  $V_R$  is the regulator output voltage setting. For example:  $V_R = 1.8V, 2.7V, 2.8V, 2.85V, 3.0V, 3.3V$ .
- 3:**  $TCV_{OUT} = \frac{(V_{OUTMAX} - V_{OUTMIN}) \times 10^6}{V_{OUT} \times \Delta T}$
- 4:**
- 5:**
- 6:** Regulation is measured at a constant junction temperature using low duty cycle pulse testing. Load regulation is tested over a load range from 1.0 mA to the maximum specified output current. Changes in output voltage due to heating effects are covered by the thermal regulation specification.
- 7:** Dropout voltage is defined as the input to output differential at which the output voltage drops 2% below its nominal value at a 1V differential.
- 8:** Thermal Regulation is defined as the change in output voltage at a time T after a change in power dissipation is applied, excluding load or line regulation effects. Specifications are for a current pulse equal to  $I_{MAX}$  at  $V_{IN} = 6V$  for  $T = 10 \text{ ms}$ .
- 9:** The maximum allowable power dissipation is a function of ambient temperature, the maximum allowable junction temperature and the thermal resistance from junction-to-air (i.e.  $T_A, T_J, \theta_{JA}$ ).
- 10:** Hysteresis voltage is referenced by  $V_R$ .
- 11:** Time required for  $V_{OUT}$  to reach 95% of  $V_R$  (output voltage setting), after  $V_{SHDN}$  is switched from 0 to  $V_{IN}$ .

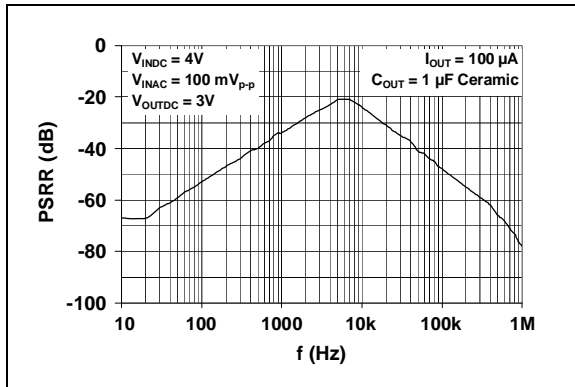
## TEMPERATURE CHARACTERISTICS

| <b>Electrical Specifications:</b> Unless otherwise noted, $V_{DD} = +2.7V$ to $+6.0V$ and $V_{SS} = GND$ . |               |     |     |      |              |            |
|--|---------------|-----|-----|------|--------------|------------|
| Parameters   | Sym           | Min | Typ | Max  | Units        | Conditions |
| <b>Temperature Ranges:</b>   |               |     |     |      |              |            |
| Extended Temperature Range   | $T_A$         | -40 | —   | +125 | $^\circ C$   |            |
| Operating Temperature Range  | $T_A$         | -40 | —   | +125 | $^\circ C$   |            |
| Storage Temperature Range  | $T_A$         | -65 | —   | +150 | $^\circ C$   |            |
| <b>Thermal Package Resistances:</b>  |               |     |     |      |              |            |
| Thermal Resistance, 5L-SOT-23  | $\theta_{JA}$ | —   | 255 | —    | $^\circ C/W$ |            |

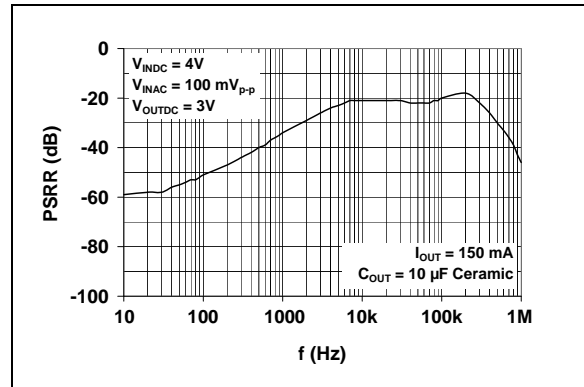
## 2.0 TYPICAL PERFORMANCE CURVES

**Note:** The graphs and tables provided following this note are a statistical summary based on a limited number of samples and are provided for informational purposes only. The performance characteristics listed herein are not tested or guaranteed. In some graphs or tables, the data presented may be outside the specified operating range (e.g., outside specified power supply range) and therefore outside the warranted range.

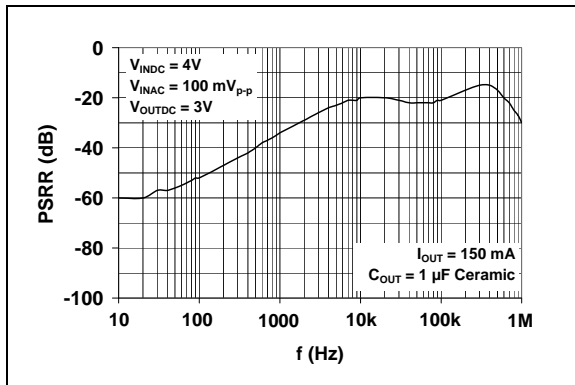
**Note:** Unless otherwise indicated,  $V_{IN} = V_R + 1V$ ,  $I_L = 100 \mu A$ ,  $C_{OUT} = 3.3 \mu F$ ,  $\overline{SHDN} > V_{IH}$ ,  $T_A = +25^\circ C$ .



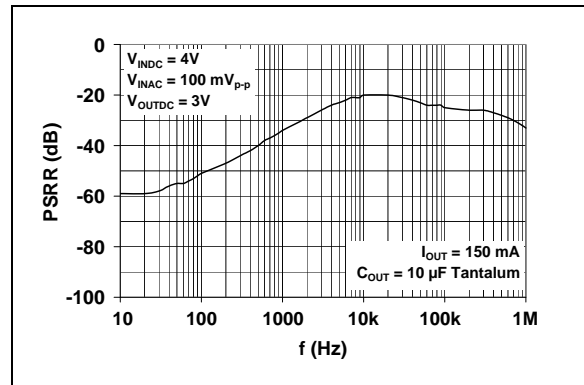
**FIGURE 2-1:** Power Supply Rejection Ratio.



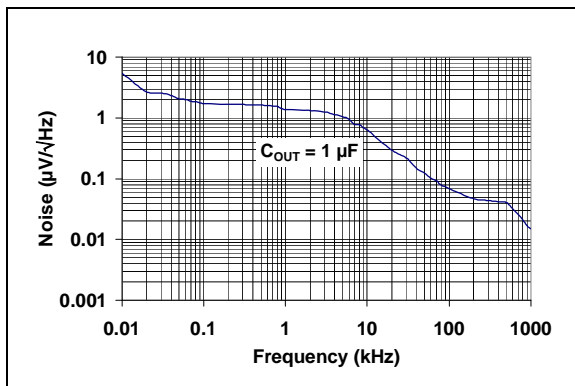
**FIGURE 2-4:** Power Supply Rejection Ratio.



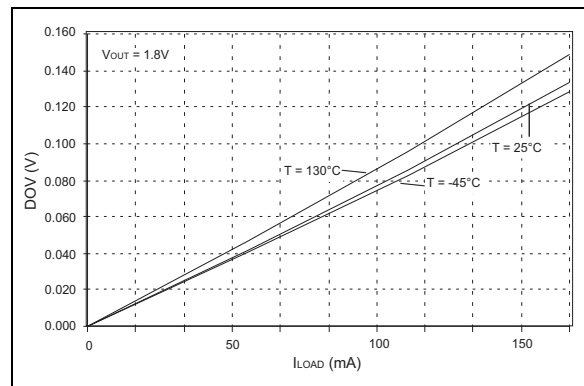
**FIGURE 2-2:** Power Supply Rejection Ratio.



**FIGURE 2-5:** Power Supply Rejection Ratio.



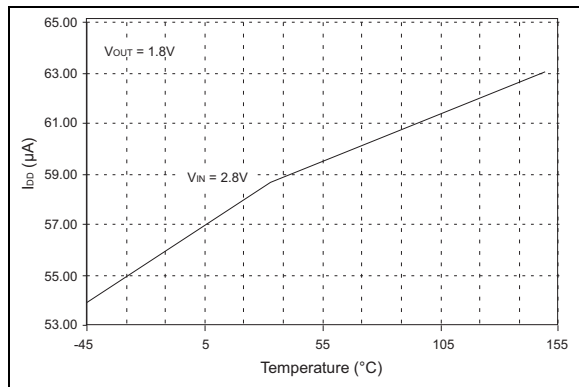
**FIGURE 2-3:** Output Noise vs. Frequency.



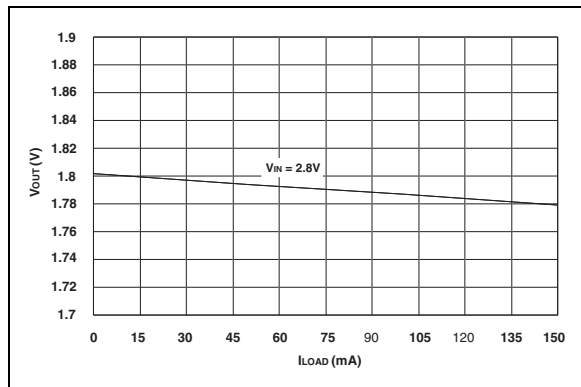
**FIGURE 2-6:** Dropout Voltage vs.  $I_{LOAD}$ .

# TC2054/2055/2186

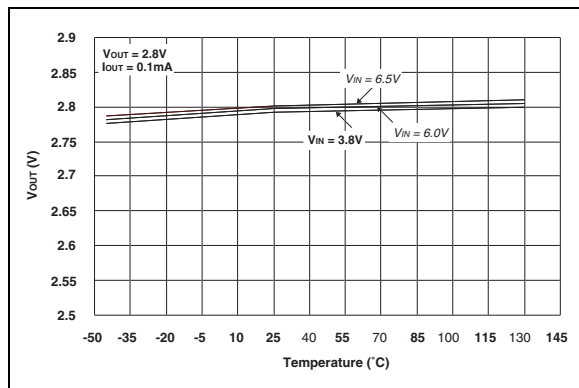
**Note:** Unless otherwise indicated,  $V_{IN} = V_R + 1V$ ,  $I_L = 100 \mu A$ ,  $C_{OUT} = 3.3 \mu F$ ,  $\overline{SHDN} > V_{IH}$ ,  $T_A = +25^\circ C$ .



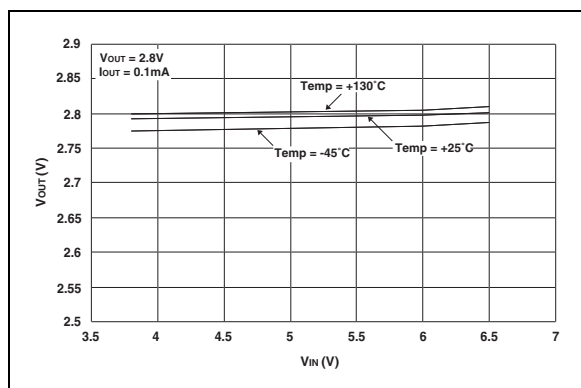
**FIGURE 2-7:**  $I_{DD}$  vs. Temperature.



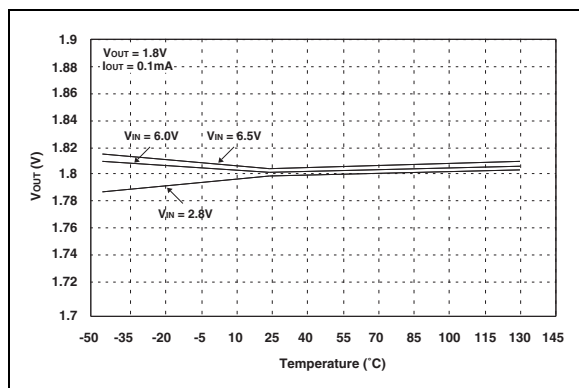
**FIGURE 2-10:** Output Voltage vs. Output Current.



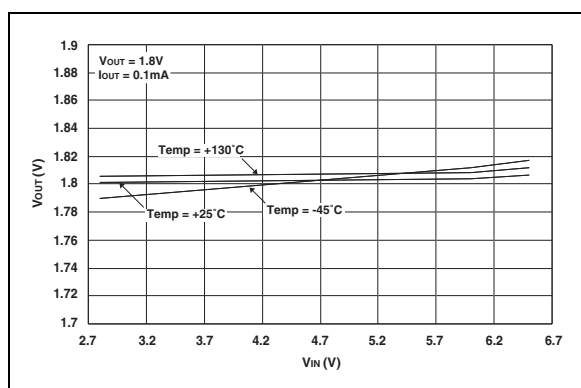
**FIGURE 2-8:** Output Voltage vs. Temperature.



**FIGURE 2-11:** Output Voltage vs. Supply Voltage.

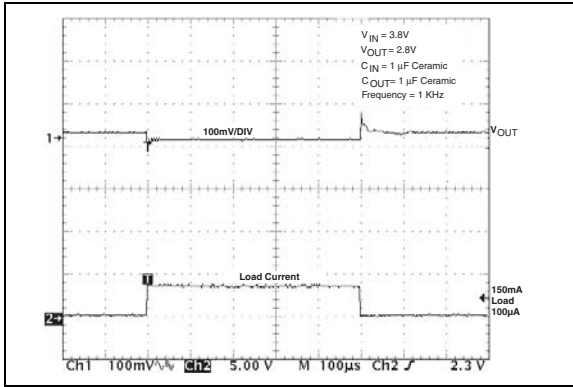


**FIGURE 2-9:** Output Voltage vs. Temperature.

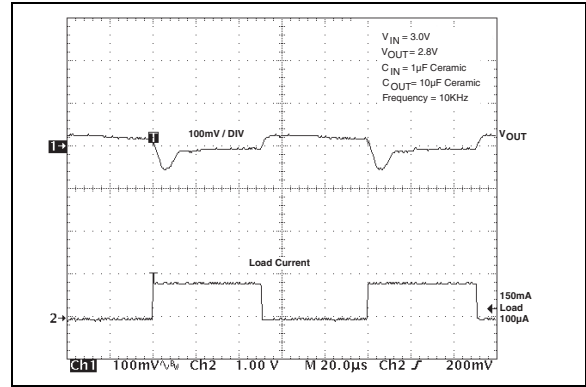


**FIGURE 2-12:** Dropout Voltage vs. Supply Voltage.

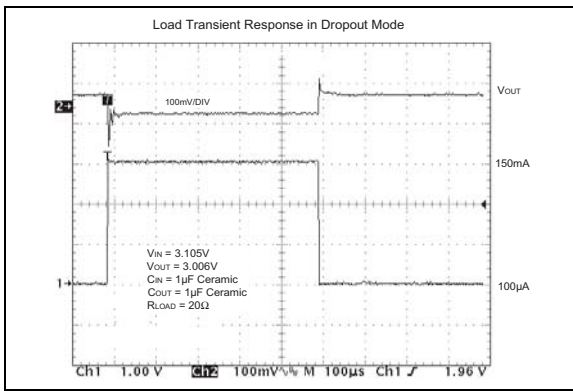
**Note:** Unless otherwise indicated,  $V_{IN} = V_R + 1V$ ,  $I_L = 100 \mu A$ ,  $C_{OUT} = 3.3 \mu F$ ,  $\overline{SHDN} > V_{IH}$ ,  $T_A = +25^\circ C$ .



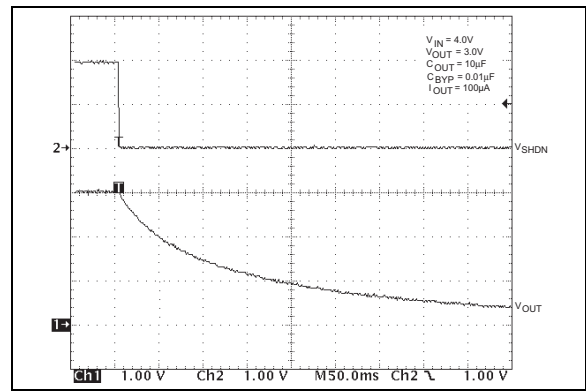
**FIGURE 2-13:** Load Transient Response.



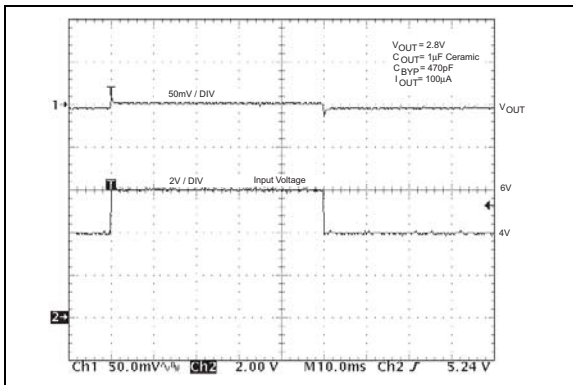
**FIGURE 2-16:** Load Transient Response.



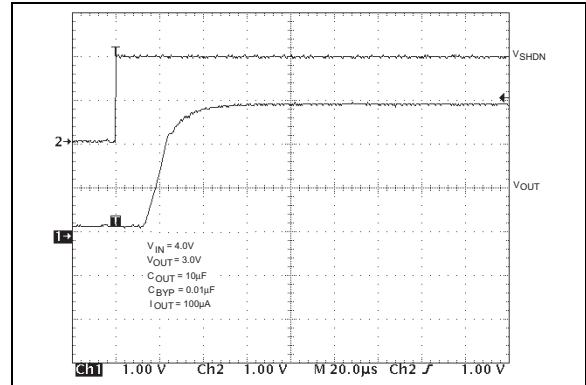
**FIGURE 2-14:** Load Transient Response in Dropout Mode.



**FIGURE 2-17:** Shutdown Delay.



**FIGURE 2-15:** Line Transient Response.



**FIGURE 2-18:** Shutdown Wake-up Time.





## 3.0 PIN DESCRIPTIONS

The descriptions of the pins are listed in [Table 3-1](#).

**TABLE 3-1: PIN FUNCTION TABLE**

| Pin Number | Symbol                    | Description  |
|------------|---------------------------|--|
| 1          | $V_{IN}$                  | Unregulated supply input.  |
| 2          | GND                       | Ground terminal.   |
| 3          | $\overline{\text{SHDN}}$  | Shutdown control input. The regulator is fully enabled when a logic high is applied to this input. The regulator enters shutdown when a logic low is applied to this input. During shutdown, output voltage falls to zero, ERROR is open circuited and supply current is reduced to 0.5 $\mu\text{A}$ (maximum). |
| 4          | $\overline{\text{ERROR}}$ | Out-of-Regulation Flag. (Open-drain output). This output goes low when $V_{OUT}$ is out-of-tolerance by approximately -5%.   |
| 5          | $V_{OUT}$                 | Regulated voltage output.  |

### 3.1 Unregulated Supply Input ( $V_{IN}$ )

Connect the unregulated input supply to the  $V_{IN}$  pin. If there is a large distance between the input supply and the LDO regulator, some input capacitance is necessary for proper operation. A 1  $\mu\text{F}$  capacitor, connected from  $V_{IN}$  to ground, is recommended for most applications.

### 3.2 Ground Terminal (GND)

Connect the unregulated input supply ground return to GND. Also connect one side of the 1  $\mu\text{F}$  typical input decoupling capacitor close to this pin and one side of the output capacitor  $C_{OUT}$  to this pin.

### 3.3 Shutdown Control Input ( $\overline{\text{SHDN}}$ )

The regulator is fully enabled when a logic-high is applied to  $\overline{\text{SHDN}}$ . The regulator enters shutdown when a logic-low is applied to this input. During shutdown, the output voltage falls to zero and the supply current is reduced to 0.5  $\mu\text{A}$  (maximum).

### 3.4 Out-of-Regulation Flag ( $\overline{\text{ERROR}}$ )

The open-drain  $\overline{\text{ERROR}}$  flag provides indication that the regulator output voltage is not in regulation. The ERROR pin will be low when the output is typically below 5% of its specified value.

### 3.5 Regulated Voltage Output ( $V_{OUT}$ )

Connect the output load to  $V_{OUT}$  of the LDO. Also connect one side of the LDO output decoupling capacitor as close as possible to the  $V_{OUT}$  pin.

NOTES:

## 4.0 DETAILED DESCRIPTION

The TC2054, TC2055 and TC2186 are precision fixed output voltage regulators. (If an adjustable version is desired, refer to the TC1070/TC1071/TC1187 data sheet (DS21353). Unlike bipolar regulators, the TC2054, TC2055 and TC2186 supply current does not increase with load current. In addition,  $V_{OUT}$  remains stable and within regulation over the entire 0 mA to maximum output current operating load range.

Figure 4-1 shows a typical application circuit. The regulator is enabled any time the shutdown input (SHDN) is at or above  $V_{IH}$ , and shutdown (disabled) when SHDN is at or below  $V_{IL}$ . SHDN may be controlled by a CMOS logic gate, or I/O port of a microcontroller. If the SHDN input is not required, it should be connected directly to the input supply. While in shutdown, supply current decreases to 0.05  $\mu$ A (typical),  $V_{OUT}$  falls to zero volts, and ERROR is open-circuited.

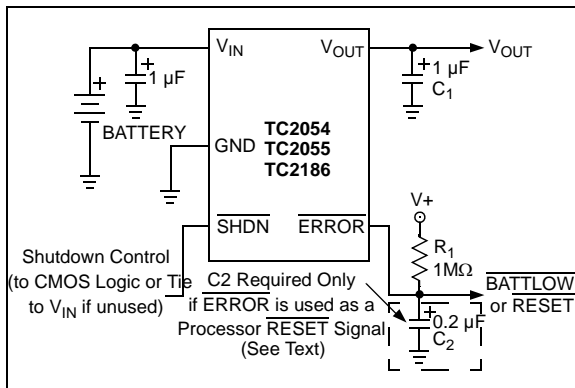


FIGURE 4-1: Typical Application Circuit.

### 4.1 ERROR Open-Drain Output

ERROR is driven low whenever  $V_{OUT}$  falls out of regulation by more than -5% (typical). This condition may be caused by low input voltage, output current limiting or thermal limiting. The ERROR threshold is 5% below rated  $V_{OUT}$  regardless of the programmed output voltage value (e.g. ERROR =  $V_{OL}$  at 4.75V (typical) for a 5.0V regulator and 2.85V (typical) for a 3.0V regulator). ERROR output operation is shown in Figure 4-2.

Note that ERROR is active when  $V_{OUT}$  falls to  $V_{TH}$ , and inactive when  $V_{OUT}$  rises above  $V_{TH}$  by  $V_{HYS}$ .

As shown in Figure 4-1, ERROR can be used as a battery low flag or as a processor RESET signal (with the addition of timing capacitor  $C_2$ ).  $R_1 \times C_2$  should be chosen to maintain ERROR below  $V_{IH}$  of the processor RESET input for at least 200 ms to allow time for the system to stabilize. Pull-up resistor  $R_1$  can be tied to  $V_{OUT}$ ,  $V_{IN}$  or any other voltage less than  $(V_{IN} + 0.3V)$ . The ERROR pin sink current is self-limiting to approximately 18 mA.

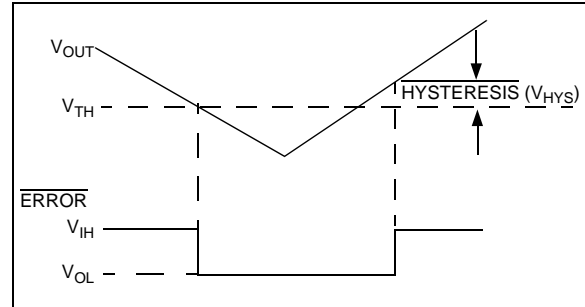


FIGURE 4-2: Error Output Operation.

### 4.2 Output Capacitor

A 1  $\mu$ F (minimum) capacitor from  $V_{OUT}$  to ground is required. The output capacitor should have an effective series resistance of 0.01 $\Omega$  to 5 $\Omega$  for  $V_{OUT} = 2.5V$ , and 0.05 $\Omega$  to 5 $\Omega$  for  $V_{OUT} < 2.5V$ . Ceramic, tantalum and aluminum electrolytic capacitors can be used. (Since many aluminum electrolytic capacitors freeze at approximately -30 $^{\circ}$ C, solid tantalums are recommended for applications operating below -25 $^{\circ}$ C). When operating from sources other than batteries, supply-noise rejection and transient response can be improved by increasing the value of the input and output capacitors and employing passive filtering techniques.

### 4.3 Input Capacitor

A 1  $\mu$ F capacitor should be connected from  $V_{IN}$  to GND if there is more than 10 inches of wire between the regulator and this AC filter capacitor, or if a battery is used as the power source. Aluminum electrolytic or tantalum capacitors can be used (since many aluminum electrolytic capacitors freeze at approximately -30 $^{\circ}$ C, solid tantalum are recommended for applications operating below -25 $^{\circ}$ C). When operating from sources other than batteries, supply-noise rejection and transient response can be improved by increasing the value of the input and output capacitors and employing passive filtering techniques.

NOTES:

## 5.0 THERMAL CONSIDERATIONS

### 5.1 Thermal Shutdown

Integrated thermal protection circuitry shuts the regulator off when the die temperature exceeds approximately 160°C. The regulator remains off until the die temperature cools to approximately 150°C.

### 5.2 Power Dissipation

The amount of power the regulator dissipates is primarily a function of input and output voltage, and output current.

Equation 5-1 is used to calculate worst case power dissipation:

#### EQUATION 5-1:

$$P_D \approx (V_{INMAX} - V_{OUTMIN})I_{LOADMAX}$$

Where:

|               |   |                                     |
|---------------|---|-------------------------------------|
| $P_D$         | = | Worst-case actual power dissipation |
| $V_{INMAX}$   | = | Maximum voltage on $V_{IN}$         |
| $V_{OUTMIN}$  | = | Minimum regulator output voltage    |
| $I_{LOADMAX}$ | = | Maximum output (load) current       |

The maximum allowable power dissipation (Equation 5-2) is a function of the maximum ambient temperature ( $T_{AMAX}$ ), the maximum allowable die temperature (125 °C) and the thermal resistance from junction-to-air ( $\theta_{JA}$ ). The 5-Pin SOT-23A package has a  $\theta_{JA}$  of approximately 220°C/Watt when mounted on a typical two layer FR4 dielectric copper clad PC board.

#### EQUATION 5-2:

$$P_{DMAX} = \frac{T_{JMAX} - T_{AMAX}}{\theta_{JA}}$$

Where all terms are previously defined.

Equation 5-1 can be used in conjunction with Equation 5-2 to ensure regulator thermal operation is within limits. For example:

Given:

$$\begin{aligned} V_{INMAX} &= 3.0V + 10\% \\ V_{OUTMIN} &= 2.7V - 2.5\% \\ I_{LOADMAX} &= 40 \text{ mA} \\ T_{AMAX} &= +55^\circ\text{C} \end{aligned}$$

Find:

1. Actual power dissipation
2. Maximum allowable dissipation

Actual power dissipation:

$$\begin{aligned} P_D &= (V_{INMAX} - V_{OUTMIN})I_{LOADMAX} \\ &= [(3.0 \times 1.1) - (2.7 \times 0.975)]40 \times 10^{-3} \\ &= 26.7 \text{ mW} \end{aligned}$$

Maximum allowable power dissipation:

$$\begin{aligned} P_{DMAX} &= \frac{T_{JMAX} - T_{AMAX}}{\theta_{JA}} \\ &= \frac{125 - 55}{220} \\ &= 318 \text{ mW} \end{aligned}$$

In this example, the TC2054 dissipates a maximum of only 26.7 mW; far below the allowable limit of 318 mW. In a similar manner, Equation 5-1 and Equation 5-2 can be used to calculate maximum current and/or input voltage limits.

### 5.3 Layout Considerations

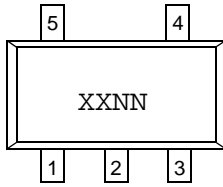
The primary path of heat conduction out of the package is via the package leads. Therefore, layouts having a ground plane, wide traces at the pads, and wide power supply bus lines combine to lower  $\theta_{JA}$  and, therefore, increase the maximum allowable power dissipation limit.

NOTES:

## 6.0 PACKAGING INFORMATION

### 6.1 Package Marking Information

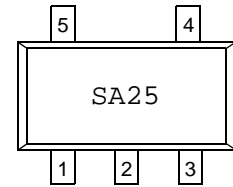
5-Lead SOT-23



**TABLE 6-1: PART NUMBER CODE AND TEMPERATURE RANGE**

| (V)  | TC2054 | TC2055 | TC2186 |
|------|--------|--------|--------|
| 1.8  | SA     | TA     | VA     |
| 2.5  | SB     | TB     | VB     |
| 2.6  | SH     | TH     | VH     |
| 2.7  | SC     | TC     | VC     |
| 2.8  | SD     | TD     | VD     |
| 2.85 | SE     | TE     | VE     |
| 3.0  | SF     | TF     | VF     |
| 3.3  | SG     | TG     | VG     |
| 5.0  | SK     | TJ     | VJ     |

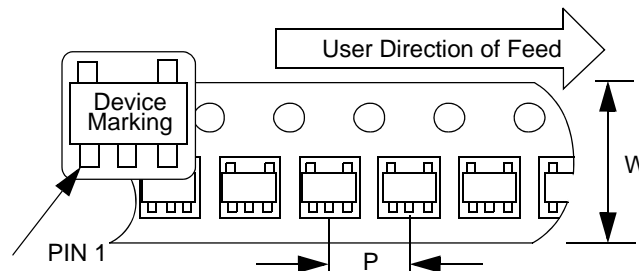
Example:



**Legend:** XX...X Customer-specific information  
 NN Alphanumeric traceability code

### 6.2 Taping Information

**Component Taping Orientation for 5-Pin SOT-23A (EIAJ SC-74A) Devices**



Standard Reel Component Orientation  
 for 713 Suffix Device  
 (Mark Right Side Up)

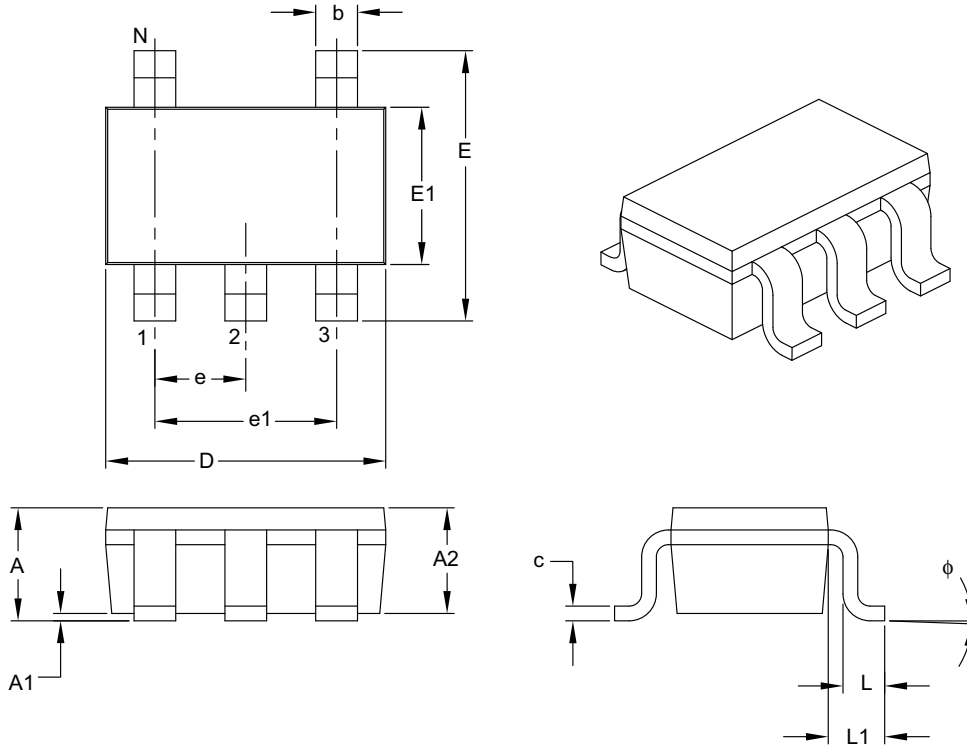
**Carrier Tape, Number of Components Per Reel and Reel Size:**

| Package       | Carrier Width (W) | Pitch (P) | Part Per Full Reel | Reel Size |
|---------------|-------------------|-----------|--------------------|-----------|
| 5-Pin SOT-23A | 8 mm              | 4 mm      | 3000               | 7 in.     |

# TC2054/2055/2186

## 5-Lead Plastic Small Outline Transistor (CT) [SOT-23]

**Note:** For the most current package drawings, please see the Microchip Packaging Specification located at <http://www.microchip.com/packaging>



| Dimension Limits         | Units  | MILLIMETERS |     |      |
|--------------------------|--------|-------------|-----|------|
|                          |        | MIN         | NOM | MAX  |
| Number of Pins           | N      | 5           |     |      |
| Lead Pitch               | e      | 0.95 BSC    |     |      |
| Outside Lead Pitch       | e1     | 1.90 BSC    |     |      |
| Overall Height           | A      | 0.90        | –   | 1.45 |
| Molded Package Thickness | A2     | 0.89        | –   | 1.30 |
| Standoff                 | A1     | 0.00        | –   | 0.15 |
| Overall Width            | E      | 2.20        | –   | 3.20 |
| Molded Package Width     | E1     | 1.30        | –   | 1.80 |
| Overall Length           | D      | 2.70        | –   | 3.10 |
| Foot Length              | L      | 0.10        | –   | 0.60 |
| Footprint                | L1     | 0.35        | –   | 0.80 |
| Foot Angle               | $\phi$ | 0°          | –   | 30°  |
| Lead Thickness           | c      | 0.08        | –   | 0.26 |
| Lead Width               | b      | 0.20        | –   | 0.51 |

**Notes:**

- Dimensions D and E1 do not include mold flash or protrusions. Mold flash or protrusions shall not exceed 0.127 mm per side.
- Dimensioning and tolerancing per ASME Y14.5M.

BSC: Basic Dimension. Theoretically exact value shown without tolerances.

Microchip Technology Drawing C04-091B



## APPENDIX A: REVISION HISTORY

### Revision D (September 2009)

The following is the list of modifications:

1. Added the 2.6V, and 5.0V option in [Table 6-1](#) in **Section 6.0 “Packaging Information”**.
2. Updated the package outline drawing.
3. Added 2.6V option to **Product Identification System** section.

### Revision C (May 2006)

The following is the list of modifications:

1. Added overtemperature to bullet for overcurrent protection in Features and General Description verbiage.
2. Added “Thermal Shutdown Die Temperature” to the Electrical Specifications table. Changed condition for “Minimum  $V_{IN}$  Operating Voltage”.
3. Added Temperature Characteristics Table.
4. Added **Section 5.1 “Thermal Shutdown”**.
5. Updated the package outline drawing.

### Revision B (May 2002)

- Data Sheet converted to Microchip standards.

### Revision A (May 2001)

- Original Release of this Document under Telcom.

NOTES:

## PRODUCT IDENTIFICATION SYSTEM

To order or obtain information, e.g., on pricing or delivery, refer to the factory or the listed sales office.

| <u>PART NO.</u>    | <u>-XX</u>  | <u>X</u>   | <u>XXXX</u> |  |
|--------------------|---|--|-------------|--|
| Device             | Output Voltage  | Temperature Range                                | Package     |  |
| Device:            | TC2054:   | 50 mA LDO with Shutdown and <u>ERROR</u> Output  |             |  |
|                    | TC2055:   | 100 mA LDO with Shutdown and <u>ERROR</u> Output |             |  |
|                    | TC2186:   | 150 mA LDO with Shutdown and ERROR Output        |             |  |
| Output Voltage:    | XX = 1.8V   |  |             |  |
|                    | XX = 2.5V   |  |             |  |
|                    | XX = 2.6V   |  |             |  |
|                    | XX = 2.7V   |  |             |  |
|                    | XX = 2.8V   |  |             |  |
|                    | XX = 2.85V  |  |             |  |
|                    | XX = 3.0V   |  |             |  |
|                    | XX = 3.3V   |  |             |  |
|                    | XX = 5.0V   |  |             |  |
| Temperature Range: | V = -40°C to +125°C   |  |             |  |
| Package:           | CTTR = Plastic Small Outline Transistor (SOT-23), 5-lead, Tape and Reel |  |             |  |
| <b>Examples:</b>   |   |  |             |  |
| a)                 | TC2054-1.8VCTTR:  | 5LD SOT-23-A, 1.8V, Tape and Reel.               |             |  |
| b)                 | TC2054-2.85VCTTR:   | 5LD SOT-23-A, 2.85V, Tape and Reel.              |             |  |
| c)                 | TC2054-3.3VCTTR:  | 5LD SOT-23-A, 3.3V, Tape and Reel.               |             |  |
| a)                 | TC2055-1.8VCTTR:  | 5LD SOT-23-A, 1.8V, Tape and Reel.               |             |  |
| b)                 | TC2055-2.85VCTTR:   | 5LD SOT-23-A, 2.85V, Tape and Reel.              |             |  |
| c)                 | TC2055-3.0VCTTR:  | 5LD SOT-23-A, 3.0V, Tape and Reel.               |             |  |
| a)                 | TC2186-1.8VCTTR:  | 5LD SOT-23-A, 1.8V, Tape and Reel.               |             |  |
| b)                 | TC2186-2.8VCTTR:  | 5LD SOT-23-A, 2.8V, Tape and Reel.               |             |  |

NOTES:

---

**Note the following details of the code protection feature on Microchip devices:**

- Microchip products meet the specification contained in their particular Microchip Data Sheet.
- Microchip believes that its family of products is one of the most secure families of its kind on the market today, when used in the intended manner and under normal conditions.
- There are dishonest and possibly illegal methods used to breach the code protection feature. All of these methods, to our knowledge, require using the Microchip products in a manner outside the operating specifications contained in Microchip's Data Sheets. Most likely, the person doing so is engaged in theft of intellectual property.
- Microchip is willing to work with the customer who is concerned about the integrity of their code.
- Neither Microchip nor any other semiconductor manufacturer can guarantee the security of their code. Code protection does not mean that we are guaranteeing the product as "unbreakable."

Code protection is constantly evolving. We at Microchip are committed to continuously improving the code protection features of our products. Attempts to break Microchip's code protection feature may be a violation of the Digital Millennium Copyright Act. If such acts allow unauthorized access to your software or other copyrighted work, you may have a right to sue for relief under that Act.

---

Information contained in this publication regarding device applications and the like is provided only for your convenience and may be superseded by updates. It is your responsibility to ensure that your application meets with your specifications. MICROCHIP MAKES NO REPRESENTATIONS OR WARRANTIES OF ANY KIND WHETHER EXPRESS OR IMPLIED, WRITTEN OR ORAL, STATUTORY OR OTHERWISE, RELATED TO THE INFORMATION, INCLUDING BUT NOT LIMITED TO ITS CONDITION, QUALITY, PERFORMANCE, MERCHANTABILITY OR FITNESS FOR PURPOSE. Microchip disclaims all liability arising from this information and its use. Use of Microchip devices in life support and/or safety applications is entirely at the buyer's risk, and the buyer agrees to defend, indemnify and hold harmless Microchip from any and all damages, claims, suits, or expenses resulting from such use. No licenses are conveyed, implicitly or otherwise, under any Microchip intellectual property rights.

**Trademarks**

The Microchip name and logo, the Microchip logo, dsPIC, KEELOQ, KEELOQ logo, MPLAB, PIC, PICmicro, PICSTART, rfPIC and UNI/O are registered trademarks of Microchip Technology Incorporated in the U.S.A. and other countries.


FilterLab, Hampshire, HI-TECH C, Linear Active Thermistor, MXDEV, MXLAB, SEEVAL and The Embedded Control Solutions Company are registered trademarks of Microchip Technology Incorporated in the U.S.A.

Analog-for-the-Digital Age, Application Maestro, CodeGuard, dsPICDEM, dsPICDEM.net, dsPICworks, dsSPEAK, ECAN, ECONOMONITOR, FanSense, HI-TIDE, In-Circuit Serial Programming, ICSP, Mindi, MiWi, MPASM, MPLAB Certified logo, MPLIB, MPLINK, mTouch, Octopus, Omniscient Code Generation, PICC, PICC-18, PICDEM, PICDEM.net, PICkit, PICtail, PIC<sup>32</sup> logo, REAL ICE, rLAB, Select Mode, Total Endurance, TSHARC, UniWinDriver, WiperLock and ZENA are trademarks of Microchip Technology Incorporated in the U.S.A. and other countries.

SQTP is a service mark of Microchip Technology Incorporated in the U.S.A.

All other trademarks mentioned herein are property of their respective companies.

© 2009, Microchip Technology Incorporated, Printed in the U.S.A., All Rights Reserved.

 Printed on recycled paper.

**QUALITY MANAGEMENT SYSTEM**  
**CERTIFIED BY DNV**  
**== ISO/TS 16949:2002 ==**

*Microchip received ISO/TS-16949:2002 certification for its worldwide headquarters, design and wafer fabrication facilities in Chandler and Tempe, Arizona; Gresham, Oregon and design centers in California and India. The Company's quality system processes and procedures are for its PIC<sup>®</sup> MCUs and dsPIC<sup>®</sup> DSCs, KEELOQ<sup>®</sup> code hopping devices, Serial EEPROMs, microperipherals, nonvolatile memory and analog products. In addition, Microchip's quality system for the design and manufacture of development systems is ISO 9001:2000 certified.*



## WORLDWIDE SALES AND SERVICE

### AMERICAS

**Corporate Office**  
2355 West Chandler Blvd.  
Chandler, AZ 85224-6199  
Tel: 480-792-7200  
Fax: 480-792-7277  
Technical Support:  
<http://support.microchip.com>  
Web Address:  
[www.microchip.com](http://www.microchip.com)

**Atlanta**  
Duluth, GA  
Tel: 678-957-9614  
Fax: 678-957-1455

**Boston**  
Westborough, MA  
Tel: 774-760-0087  
Fax: 774-760-0088

**Chicago**  
Itasca, IL  
Tel: 630-285-0071  
Fax: 630-285-0075

**Cleveland**  
Independence, OH  
Tel: 216-447-0464  
Fax: 216-447-0643

**Dallas**  
Addison, TX  
Tel: 972-818-7423  
Fax: 972-818-2924

**Detroit**  
Farmington Hills, MI  
Tel: 248-538-2250  
Fax: 248-538-2260

**Kokomo**  
Kokomo, IN  
Tel: 765-864-8360  
Fax: 765-864-8387

**Los Angeles**  
Mission Viejo, CA  
Tel: 949-462-9523  
Fax: 949-462-9608

**Santa Clara**  
Santa Clara, CA  
Tel: 408-961-6444  
Fax: 408-961-6445

**Toronto**  
Mississauga, Ontario,  
Canada  
Tel: 905-673-0699  
Fax: 905-673-6509

### ASIA/PACIFIC

**Asia Pacific Office**  
Suites 3707-14, 37th Floor  
Tower 6, The Gateway  
Harbour City, Kowloon  
Hong Kong  
Tel: 852-2401-1200  
Fax: 852-2401-3431

**Australia - Sydney**  
Tel: 61-2-9868-6733  
Fax: 61-2-9868-6755

**China - Beijing**  
Tel: 86-10-8528-2100  
Fax: 86-10-8528-2104

**China - Chengdu**  
Tel: 86-28-8665-5511  
Fax: 86-28-8665-7889

**China - Hong Kong SAR**  
Tel: 852-2401-1200  
Fax: 852-2401-3431

**China - Nanjing**  
Tel: 86-25-8473-2460  
Fax: 86-25-8473-2470

**China - Qingdao**  
Tel: 86-532-8502-7355  
Fax: 86-532-8502-7205

**China - Shanghai**  
Tel: 86-21-5407-5533  
Fax: 86-21-5407-5066

**China - Shenyang**  
Tel: 86-24-2334-2829  
Fax: 86-24-2334-2393

**China - Shenzhen**  
Tel: 86-755-8203-2660  
Fax: 86-755-8203-1760

**China - Wuhan**  
Tel: 86-27-5980-5300  
Fax: 86-27-5980-5118

**China - Xiamen**  
Tel: 86-592-2388138  
Fax: 86-592-2388130

**China - Xian**  
Tel: 86-29-8833-7252  
Fax: 86-29-8833-7256

**China - Zhuhai**  
Tel: 86-756-3210040  
Fax: 86-756-3210049

### ASIA/PACIFIC

**India - Bangalore**  
Tel: 91-80-3090-4444  
Fax: 91-80-3090-4080

**India - New Delhi**  
Tel: 91-11-4160-8631  
Fax: 91-11-4160-8632

**India - Pune**  
Tel: 91-20-2566-1512  
Fax: 91-20-2566-1513

**Japan - Yokohama**  
Tel: 81-45-471- 6166  
Fax: 81-45-471-6122

**Korea - Daegu**  
Tel: 82-53-744-4301  
Fax: 82-53-744-4302

**Korea - Seoul**  
Tel: 82-2-554-7200  
Fax: 82-2-558-5932 or  
82-2-558-5934

**Malaysia - Kuala Lumpur**  
Tel: 60-3-6201-9857  
Fax: 60-3-6201-9859

**Malaysia - Penang**  
Tel: 60-4-227-8870  
Fax: 60-4-227-4068

**Philippines - Manila**  
Tel: 63-2-634-9065  
Fax: 63-2-634-9069

**Singapore**  
Tel: 65-6334-8870  
Fax: 65-6334-8850

**Taiwan - Hsin Chu**  
Tel: 886-3-6578-300  
Fax: 886-3-6578-370

**Taiwan - Kaohsiung**  
Tel: 886-7-536-4818  
Fax: 886-7-536-4803

**Taiwan - Taipei**  
Tel: 886-2-2500-6610  
Fax: 886-2-2508-0102

**Thailand - Bangkok**  
Tel: 66-2-694-1351  
Fax: 66-2-694-1350

### EUROPE

**Austria - Wels**  
Tel: 43-7242-2244-39  
Fax: 43-7242-2244-393

**Denmark - Copenhagen**  
Tel: 45-4450-2828  
Fax: 45-4485-2829

**France - Paris**  
Tel: 33-1-69-53-63-20  
Fax: 33-1-69-30-90-79

**Germany - Munich**  
Tel: 49-89-627-144-0  
Fax: 49-89-627-144-44

**Italy - Milan**  
Tel: 39-0331-742611  
Fax: 39-0331-466781

**Netherlands - Drunen**  
Tel: 31-416-690399  
Fax: 31-416-690340

**Spain - Madrid**  
Tel: 34-91-708-08-90  
Fax: 34-91-708-08-91

**UK - Wokingham**  
Tel: 44-118-921-5869  
Fax: 44-118-921-5820

## X-ON Electronics

Largest Supplier of Electrical and Electronic Components

*Click to view similar products for [LDO Voltage Regulators](#) category:*

*Click to view products by [Microchip](#) manufacturer:*

Other Similar products are found below :

[AP7363-SP-13](#) [L79M05TL-E](#) [PT7M8202B12TA5EX](#) [TCR3DF185,LM\(CT](#) [TCR3DF24,LM\(CT](#) [TCR3DF285,LM\(CT](#) [TCR3DF31,LM\(CT](#)  
[TCR3DF45,LM\(CT](#) [MP2013GQ-33-Z](#) [059985X](#) [NCP4687DH15T1G](#) [701326R](#) [TCR2EN28,LF\(S](#) [NCV8170AXV250T2G](#)  
[TCR3DF27,LM\(CT](#) [TCR3DF19,LM\(CT](#) [TCR3DF125,LM\(CT](#) [TCR2EN18,LF\(S](#) [AP7315-25W5-7](#) [IFX30081LDVGRNXUMA1](#)  
[NCV47411PAAJR2G](#) [AP2113KTR-G1](#) [AP2111H-1.2TRG1](#) [ZLDO1117QK50TC](#) [AZ1117IH-1.8TRG1](#) [TCR3DG12,LF](#) [MIC5514-3.3YMT-](#)  
[T5](#) [MIC5512-1.2YMT-T5](#) [MIC5317-2.8YM5-T5](#) [SCD7912BTG](#) [NCP154MX180270TAG](#) [SCD33269T-5.0G](#) [NCV8170BMX330TCG](#)  
[NCV8170AMX120TCG](#) [NCP706ABMX300TAG](#) [NCP153MX330180TCG](#) [NCP114BMX075TCG](#) [MC33269T-3.5G](#) [CAT6243-ADJCMT5T](#)  
[TCR3DG33,LF](#) [AP2127N-1.0TRG1](#) [TCR4DG35,LF](#) [LT1117CST-3.3](#) [LT1117CST-5](#) [TAR5S15U\(TE85L,F\)](#) [TAR5S18U\(TE85L,F\)](#)  
[TCR3UG19A,LF](#) [TCR4DG105,LF](#) [NCV8170AMX360TCG](#) [MIC94310-NYMT-T5](#)