



MICROCHIP TC4423A/TC4424A/TC4425A

3A Dual High-Speed Power MOSFET Drivers

Features

- High Peak Output Current: 4.5A (typical)
- Wide Input Supply Voltage Operating Range:
 - 4.5V to 18V
- High Capacitive Load Drive Capability:
 - 1800 pF in 12 ns
- Short Delay Times: 40 ns (typical)
- Matched Rise/Fall Times
- Low Supply Current:
 - With Logic '1' Input – 1.0 mA (maximum)
 - With Logic '0' Input – 150 μ A (maximum)
- Low Output Impedance: 2.5 Ω (typical)
- Latch-Up Protected: Will Withstand 1.5A Reverse Current
- Logic Input Will Withstand Negative Swing Up To 5V
- Pin compatible with the TC4423/TC4424/TC4425 and TC4426A/TC4427A/TC4428A devices
- Space-saving 8-Pin 150 mil body SOIC and 8-Pin 6x5 DFN Packages

Applications

- Switch Mode Power Supplies
- Pulse Transformer Drive
- Line Drivers
- Direct Drive of Small DC Motors

General Description

The TC4423A/TC4424A/TC4425A devices are a family of dual-output 3A buffers/MOSFET drivers. These devices are improved versions of the earlier TC4423/TC4424/TC4425 dual-output 3A driver family. This improved version features higher peak output current drive capability, lower shoot-through current, matched rise/fall times and propagation delay times. The TC4423A/TC4424A/TC4425A devices are pin-compatible with the existing TC4423/TC4424/TC4425 family. An 8-pin SOIC package option has been added to the family. The 8-pin DFN package option offers increased power dissipation capability for driving heavier capacitive or resistive loads.

The TC4423A/TC4424A/TC4425A MOSFET drivers can easily charge and discharge 1800 pF gate capacitance in under 20 ns, provide low enough impedances in both the on and off states to ensure the MOSFET's intended state will not be affected, even by large transients.

The TC4423A/TC4424A/TC4425A inputs may be driven directly from either TTL or CMOS (2.4V to 18V). In addition, the 300 mV of built-in hysteresis provides noise immunity and allows the device to be driven from slow rising or falling waveforms.

The TC4423A/TC4424A/TC4425A dual-output 3A MOSFET driver family is offered with a -40°C to +125°C temperature rating, making it useful in any wide temperature range application.

Package Types

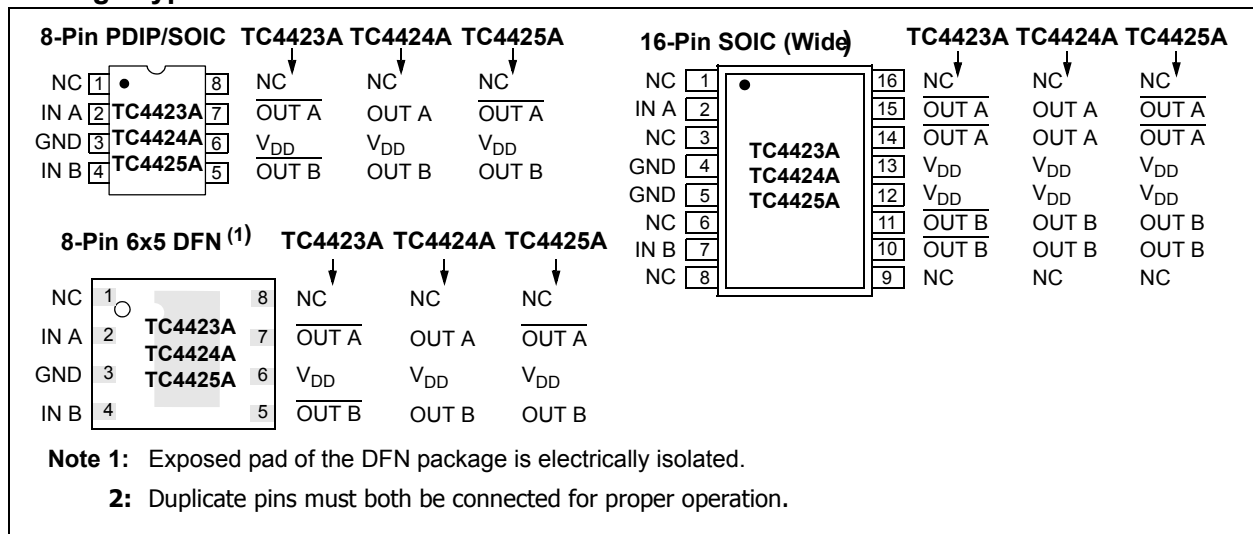

TC4423A/TC4424A/TC4425A

Functional Block Diagram⁽¹⁾

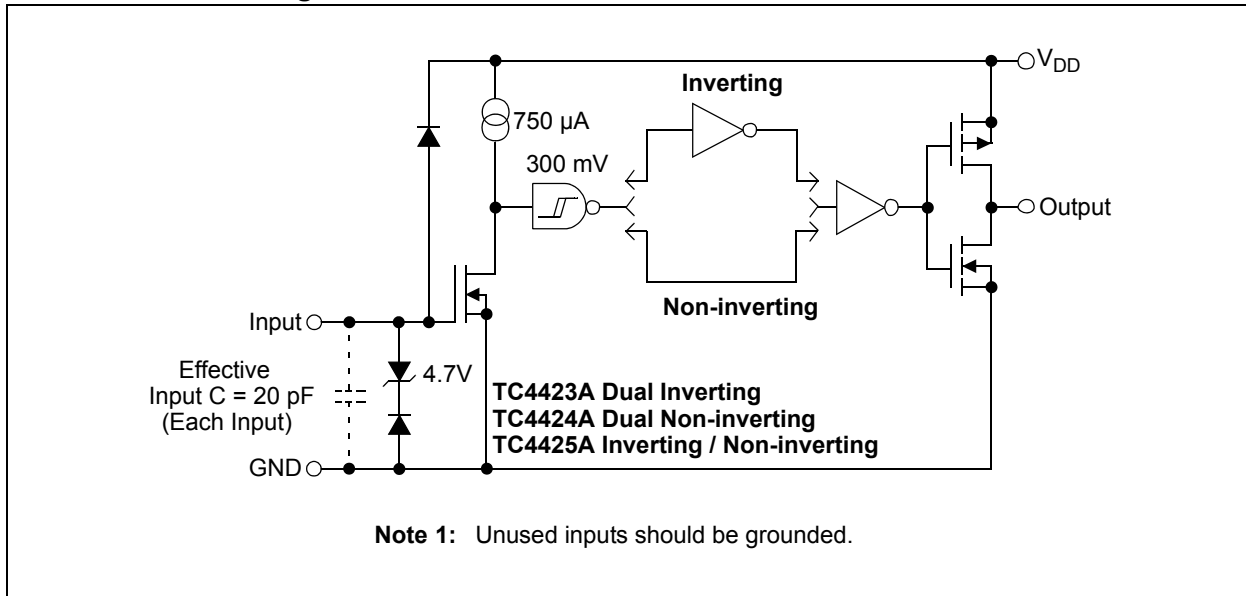

TC4423A/TC4424A/TC4425A

1.0 ELECTRICAL CHARACTERISTICS

† **Notice:** Stresses above those listed under "Maximum Ratings" may cause permanent damage to the device. This is a stress rating only and functional operation of the device at those or any other conditions above those indicated in the operational sections of this specification is not intended. Exposure to maximum rating conditions for extended periods may affect device reliability.

Absolute Maximum Ratings †

Supply Voltage	+20V
Input Voltage, IN A or IN B	(V _{DD} + 0.3V) to (GND – 5V)
Package Power Dissipation (T _A =50°C)	
8L PDIP	1.2W
8L SOIC	0.61W
16L SOIC	1.1W
8L DFN	Note 3

DC CHARACTERISTICS (NOTE 2)

Electrical Specifications: Unless otherwise indicated, T _A = +25°C, with 4.5V ≤ V _{DD} ≤ 18V.						
Parameters	Sym	Min	Typ	Max	Units	Conditions
Input						
Logic '1', High Input Voltage	V _{IH}	2.4	1.5	—	V	
Logic '0', Low Input Voltage	V _{IL}	—	1.3	0.8	V	
Input Current	I _{IN}	–1	—	1	μA	0V ≤ V _{IN} ≤ V _{DD}
Input Voltage	V _{IN}	–5	—	V _{DD} +0.3	V	
Output						
High Output Voltage	V _{OH}	V _{DD} – 0.025	—	—	V	DC Test
Low Output Voltage	V _{OL}	—	—	0.025	V	DC Test
Output Resistance, High	R _{OH}	—	2.2	3.0	Ω	I _{OUT} = 10 mA, V _{DD} = 18V
Output Resistance, Low	R _{OL}	—	2.8	3.5	Ω	I _{OUT} = 10 mA, V _{DD} = 18V
Peak Output Current	I _{PK}	—	4.5	—	A	10V ≤ V _{DD} ≤ 18V (Note 2)
Latch-Up Protection Withstand Reverse Current	I _{REV}	—	>1.5	—	A	Duty cycle ≤ 2%, t ≤ 300 μsec.
Switching Time (Note 1)						
Rise Time	t _R	—	12	21	ns	Figure 4-1, Figure 4-2, C _L = 1800 pF
Fall Time	t _F	—	12	21	ns	Figure 4-1, Figure 4-2, C _L = 1800 pF
Delay Time	t _{D1}	—	40	48	ns	Figure 4-1, Figure 4-2, C _L = 1800 pF
Delay Time	t _{D2}	—	41	48	ns	Figure 4-1, Figure 4-2, C _L = 1800 pF
Power Supply						
Supply Voltage	V _{DD}	4.5	—	18	V	
Power Supply Current	I _S	—	1.0	2.0	mA	V _{IN} = 3V (Both inputs)
	I _S	—	0.15	0.25	mA	V _{IN} = 0V (Both inputs)

Note 1: Switching times ensured by design.

2: Tested during characterization, not production tested.

3: Package power dissipation is dependent on the copper pad area on the PCB.

TC4423A/TC4424A/TC4425A

DC CHARACTERISTICS (OVER OPERATING TEMPERATURE RANGE)

Electrical Specifications: Unless otherwise indicated, operating temperature range with $4.5V \leq V_{DD} \leq 18V$.						
Parameters	Sym	Min	Typ	Max	Units	Conditions
Input						
Logic '1', High Input Voltage	V_{IH}	2.4	—	—	V	
Logic '0', Low Input Voltage	V_{IL}	—	—	0.8	V	
Input Current	I_{IN}	-10	—	+10	μA	$0V \leq V_{IN} \leq V_{DD}$
Output						
High Output Voltage	V_{OH}	$V_{DD} - 0.025$	—	—	V	
Low Output Voltage	V_{OL}	—	—	0.025	V	
Output Resistance, High	R_{OH}	—	3.1	6	Ω	$I_{OUT} = 10 \text{ mA}, V_{DD} = 18V$
Output Resistance, Low	R_{OL}	—	3.7	7	Ω	$I_{OUT} = 10 \text{ mA}, V_{DD} = 18V$
Switching Time (Note 1)						
Rise Time	t_R	—	20	31	ns	Figure 4-1, Figure 4-2, $C_L = 1800 \text{ pF}$
Fall Time	t_F	—	22	31	ns	Figure 4-1, Figure 4-2, $C_L = 1800 \text{ pF}$
Delay Time	t_{D1}	—	50	66	ns	Figure 4-1, Figure 4-2, $C_L = 1800 \text{ pF}$
Delay Time	t_{D2}	—	50	66	ns	Figure 4-1, Figure 4-2, $C_L = 1800 \text{ pF}$
Power Supply						
Power Supply Current	I_S	— —	2.0 0.2	3.0 0.3	mA	$V_{IN} = 3V$ (Both inputs) $V_{IN} = 0V$ (Both inputs)

Note 1: Switching times ensured by design.

TEMPERATURE CHARACTERISTICS

Electrical Specifications: Unless otherwise noted, all parameters apply with $4.5V \leq V_{DD} \leq 18V$.						
Parameters	Sym	Min	Typ	Max	Units	Conditions
Temperature Ranges						
Specified Temperature Range (V)	T_A	-40	—	+125	$^{\circ}C$	
Maximum Junction Temperature	T_J	—	—	+150	$^{\circ}C$	
Storage Temperature Range	T_A	-65	—	+150	$^{\circ}C$	
Package Thermal Resistances						
Thermal Resistance, 8L-6x5 DFN	θ_{JA}	—	33.2	—	$^{\circ}C/W$	Typical four-layer board with vias to ground plane
Thermal Resistance, 8L-PDIP	θ_{JA}	—	84.6	—	$^{\circ}C/W$	
Thermal Resistance, 8L-SOIC	θ_{JA}	—	163	—	$^{\circ}C/W$	
Thermal Resistance, 16L-SOIC	θ_{JA}	—	90	—	$^{\circ}C/W$	

TC4423A/TC4424A/TC4425A

2.0 TYPICAL PERFORMANCE CURVES

Note: The graphs and tables provided following this note are a statistical summary based on a limited number of samples and are provided for informational purposes only. The performance characteristics listed herein are not tested or guaranteed. In some graphs or tables, the data presented may be outside the specified operating range (e.g., outside specified power supply range) and therefore outside the warranted range.

Note: Unless otherwise indicated, $T_A = +25^\circ\text{C}$ with $4.5\text{V} \leq V_{DD} \leq 18\text{V}$.

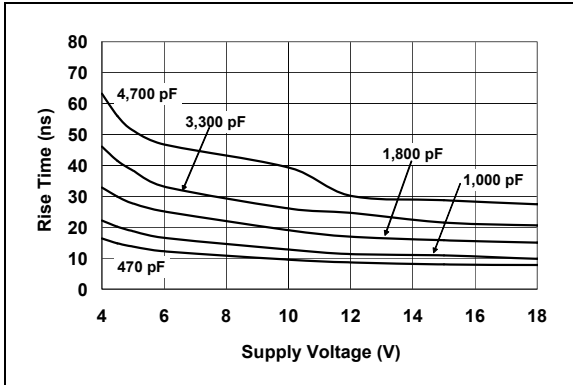

FIGURE 2-1: Rise Time vs. Supply Voltage.

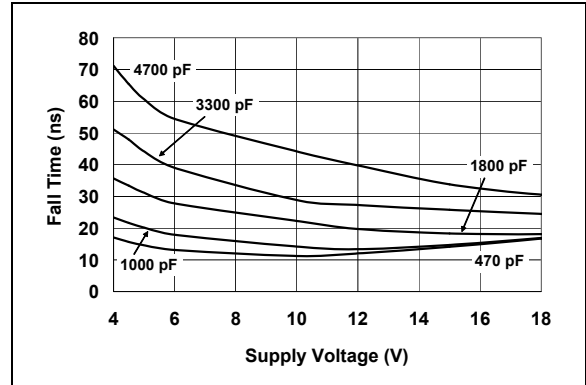

FIGURE 2-4: Fall Time vs. Supply Voltage.

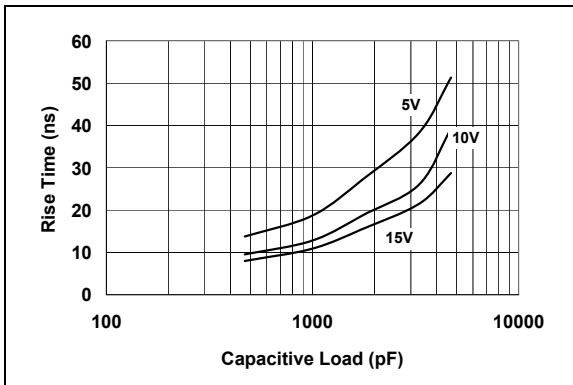

FIGURE 2-2: Rise Time vs. Capacitive Load.

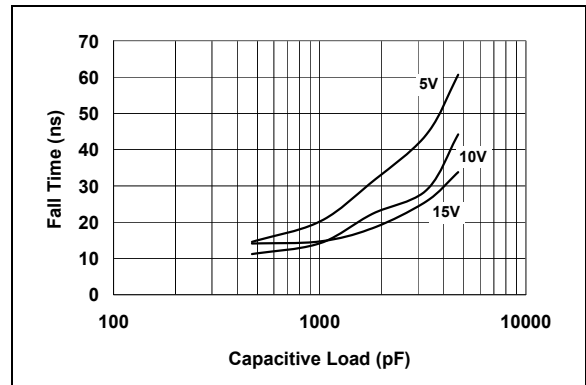

FIGURE 2-5: Fall Time vs. Capacitive Load.

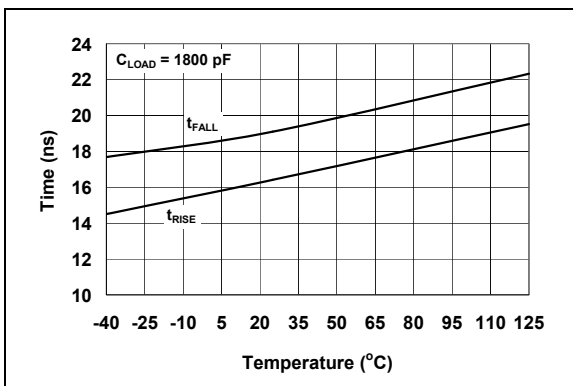

FIGURE 2-3: Rise and Fall Times vs. Temperature.

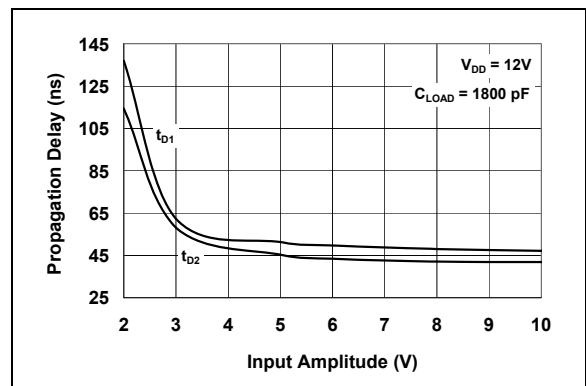

FIGURE 2-6: Propagation Delay vs. Input Amplitude.

TC4423A/TC4424A/TC4425A

Typical Performance Curves (Continued)

Note: Unless otherwise indicated, $T_A = +25^\circ\text{C}$ with $4.5\text{V} \leq V_{DD} \leq 18\text{V}$.

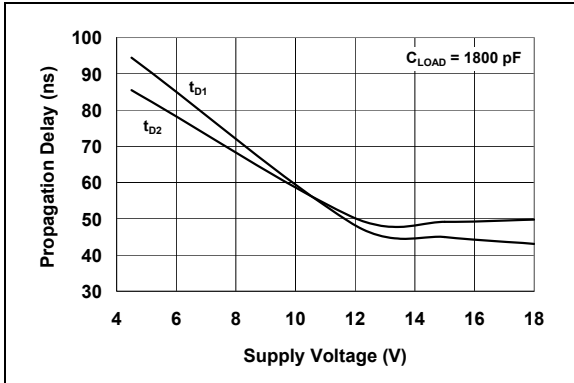

FIGURE 2-7: Propagation Delay Time vs. Supply Voltage.

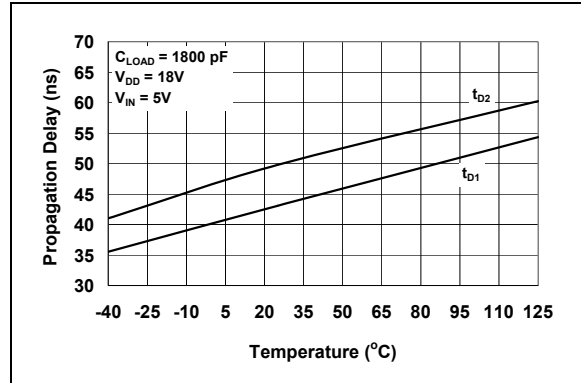

FIGURE 2-10: Propagation Delay Time vs. Temperature.

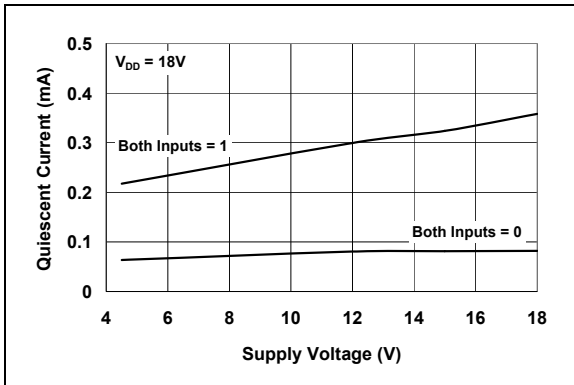

FIGURE 2-8: Quiescent Current vs. Supply Voltage.

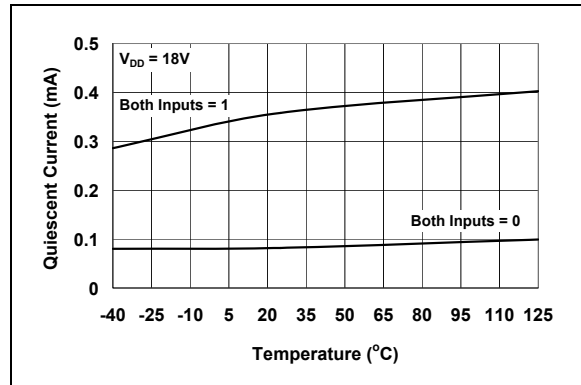

FIGURE 2-11: Quiescent Current vs. Temperature.

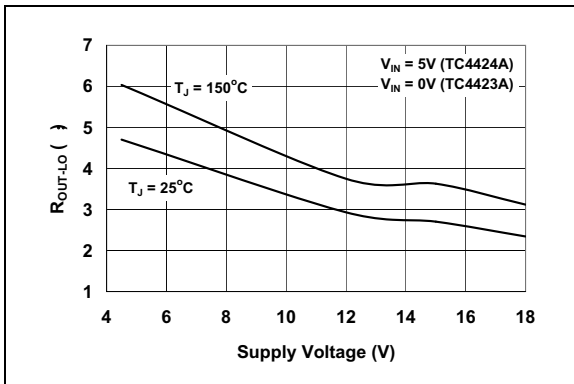

FIGURE 2-9: Output Resistance (Output Low) vs. Supply Voltage.

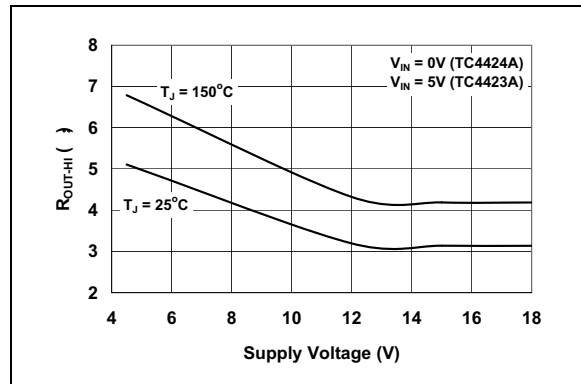

FIGURE 2-12: Output Resistance (Output High) vs. Supply Voltage.

TC4423A/TC4424A/TC4425A

Typical Performance Curves (Continued)

Note: Unless otherwise indicated, $T_A = +25^\circ\text{C}$ with $4.5\text{V} \leq V_{DD} \leq 18\text{V}$.

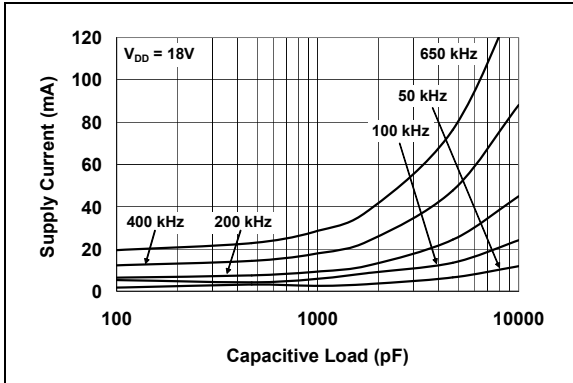

FIGURE 2-13: Supply Current vs. Capacitive Load.

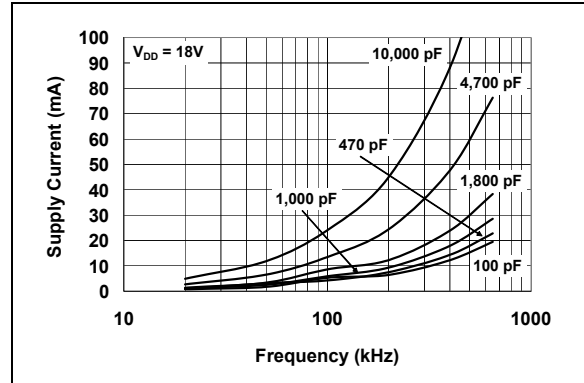

FIGURE 2-16: Supply Current vs. Frequency.

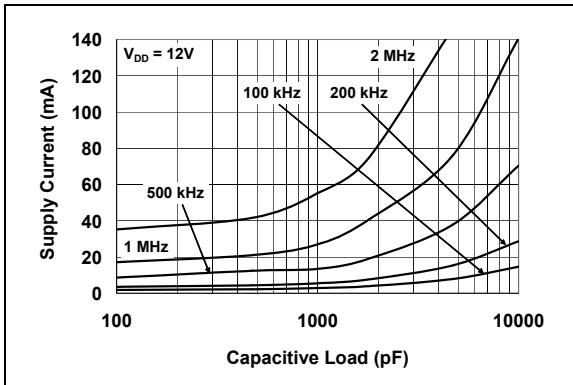

FIGURE 2-14: Supply Current vs. Capacitive Load.

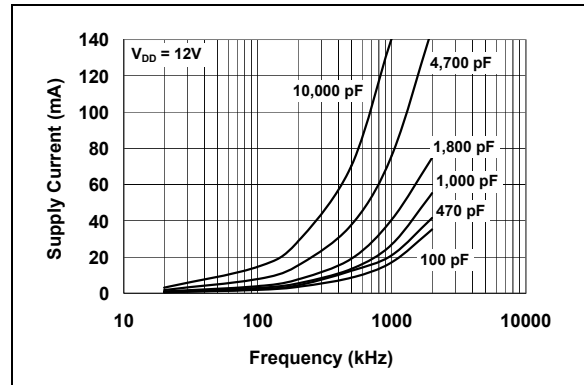

FIGURE 2-17: Supply Current vs. Frequency.

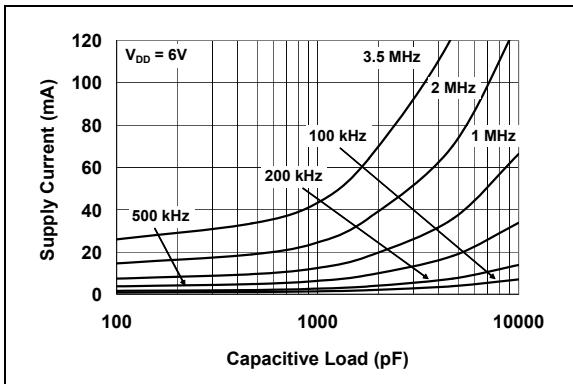

FIGURE 2-15: Supply Current vs. Capacitive Load.

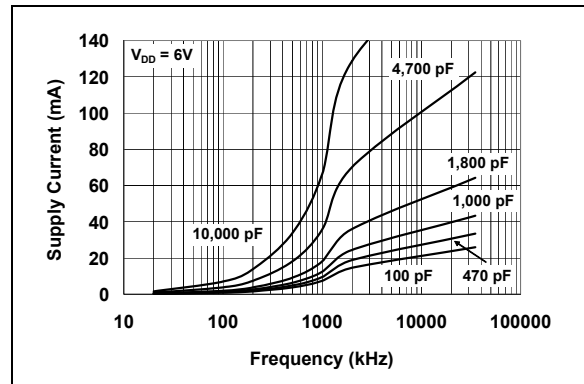

FIGURE 2-18: Supply Current vs. Frequency.

TC4423A/TC4424A/TC4425A

Typical Performance Curves (Continued)

Note: Unless otherwise indicated, $T_A = +25^\circ\text{C}$ with $4.5\text{V} \leq V_{DD} \leq 18\text{V}$.

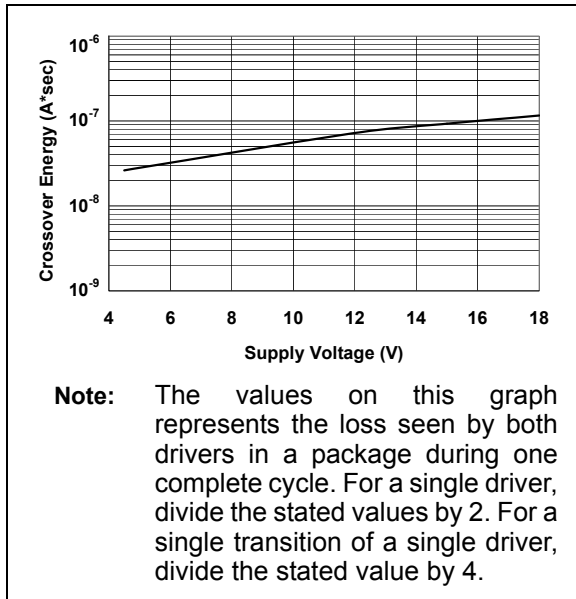

FIGURE 2-19: Crossover Energy vs. Supply Voltage.

3.0 PIN DESCRIPTIONS

The descriptions of the pins are listed in Table 3-1.

TABLE 3-1: PIN FUNCTION TABLE (1)

8-Pin PDIP	8-Pin DFN	16-Pin SOIC (Wide)	Symbol	Description
1	1	1	NC	No connection
2	2	2	IN A	Input A
—	—	3	NC	No connection
3	3	4	GND	Ground
—	—	5	GND	Ground
—	—	6	NC	No connection
4	4	7	IN B	Input B
—	—	8	NC	No connection
—	—	9	NC	No connection
5	5	10	OUT B	Output B
—	—	11	OUT B	Output B
6	6	12	V _{DD}	Supply input
—	—	13	V _{DD}	Supply input
7	7	14	OUT A	Output A
—	—	15	OUT A	Output A
8	8	16	NC	No connection
—	PAD	—	NC	Exposed Metal Pad

Note 1: Duplicate pins must be connected for proper operation.

3.1 Inputs A and B

Inputs A and B are TTL/CMOS compatible inputs that control outputs A and B, respectively. These inputs have 300 mV of hysteresis between the high and low input levels, allowing them to be driven from slow rising and falling signals, and to provide noise immunity.

3.2 Outputs A and B

Outputs A and B are CMOS push-pull outputs that are capable of sourcing and sinking 3A peaks of current (V_{DD} = 18V). The low output impedance ensures the gate of the external MOSFET will stay in the intended state even during large transients. These outputs also have a reverse current latch-up rating of 1.5A.

3.3 Supply Input (V_{DD})

V_{DD} is the bias supply input for the MOSFET driver and has a voltage range of 4.5V to 18V. This input must be decoupled to ground with a local ceramic capacitor. This bypass capacitor provides a localized low-impedance path for the peak currents that are to be provided to the load.

3.4 Ground (GND)

Ground is the device return pin. The ground pin should have a low-impedance connection to the bias supply source return. High peak currents will flow out the ground pin when the capacitive load is being discharged.

3.5 Exposed Metal Pad

The exposed metal pad of the DFN package is not internally connected to any potential. Therefore, this pad can be connected to a ground plane or other copper plane on a printed circuit board to aid in heat removal from the package.

TC4423A/TC4424A/TC4425A

4.0 APPLICATIONS INFORMATION

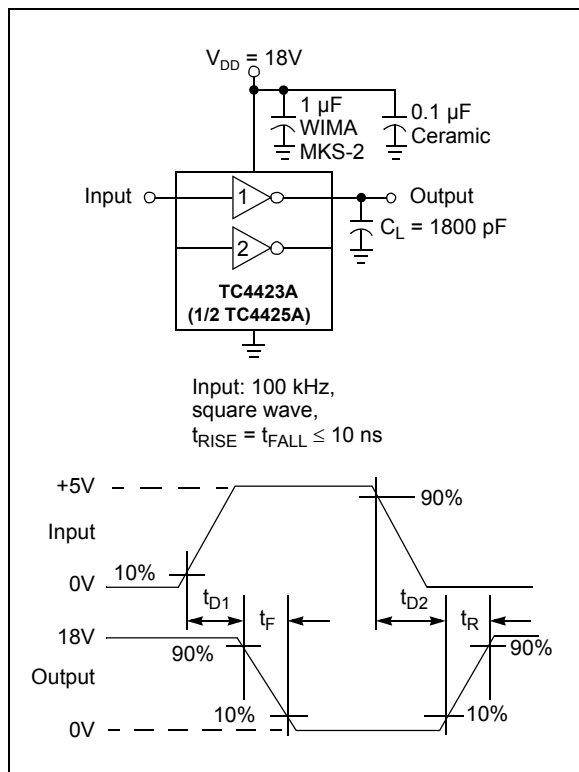

FIGURE 4-1: Inverting Driver Switching Time.

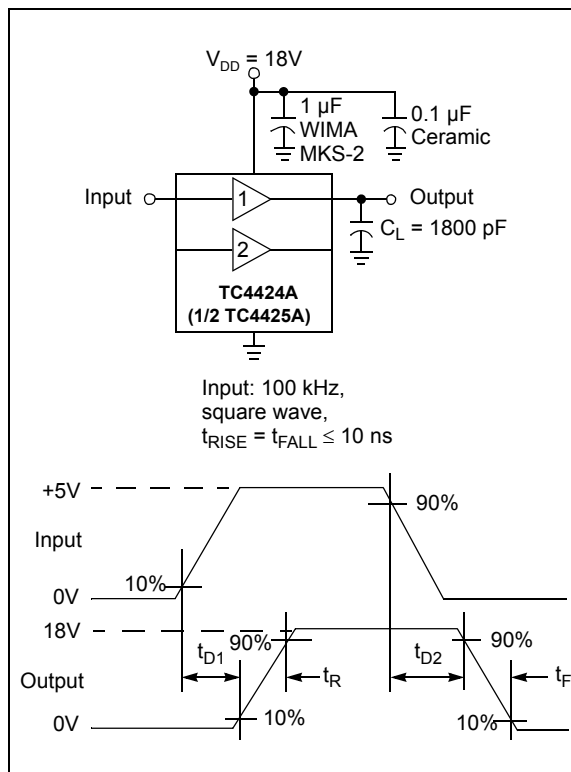

FIGURE 4-2: Non-inverting Driver Switching Time.

TC4423A/TC4424A/TC4425A

5.0 PACKAGING INFORMATION

5.1 Package Marking Information (Not to Scale)

8-Lead DFN (6x5)

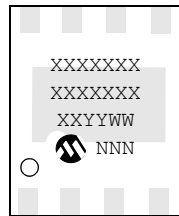

Example:

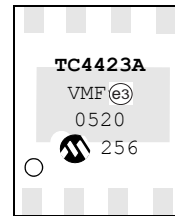

8-Lead PDIP (300 mil)

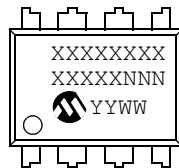

Example:

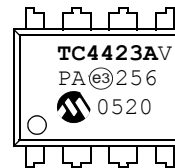

8-Lead SOIC (150 mil)

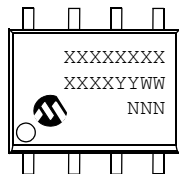

Example:

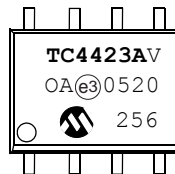

16-Lead SOIC (300 mil)

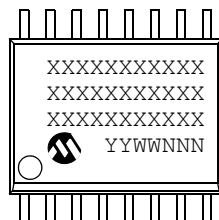

Example:

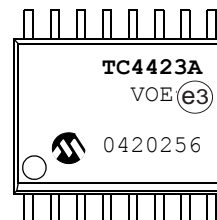

Legend:	XX...X	Customer-specific information
	Y	Year code (last digit of calendar year)
	YY	Year code (last 2 digits of calendar year)
	WW	Week code (week of January 1 is week '01')
	NNN	Alphanumeric traceability code
	(e3)	Pb-free JEDEC designator for Matte Tin (Sn)
	*	This package is Pb-free. The Pb-free JEDEC designator (e3) can be found on the outer packaging for this package.

Note: In the event the full Microchip part number cannot be marked on one line, it will be carried over to the next line, thus limiting the number of available characters for customer-specific information.

TC4423A/TC4424A/TC4425A

8-Lead Plastic Dual Flat, No Lead Package (MF) – 6x5 mm Body [DFN-S] PUNCH SINGULATED

Note: For the most current package drawings, please see the Microchip Packaging Specification located at <http://www.microchip.com/packaging>

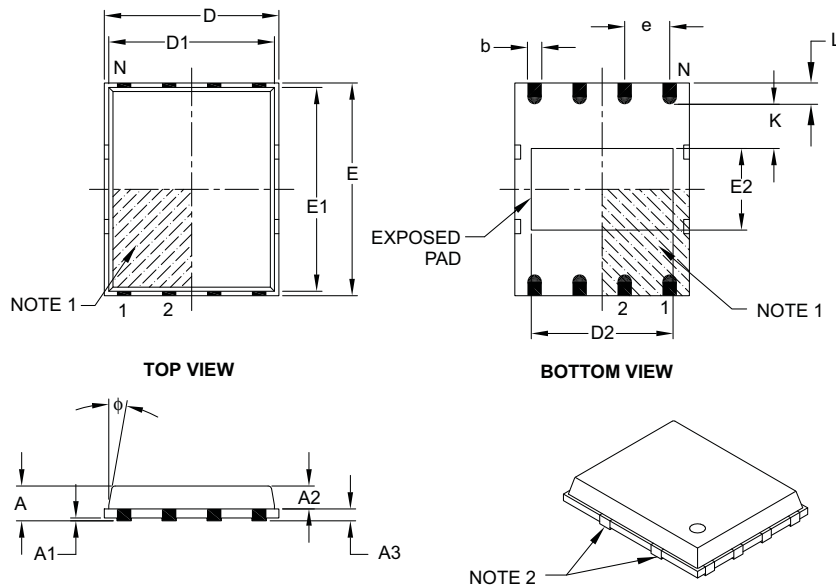

Dimension Limits	Units	MILLIMETERS		
		MIN	NOM	MAX
Number of Pins	N	8		
Pitch	e	1.27 BSC		
Overall Height	A	–	0.85	1.00
Molded Package Thickness	A2	–	0.65	0.80
Standoff	A1	0.00	0.01	0.05
Base Thickness	A3	0.20 REF		
Overall Length	D	4.92 BSC		
Molded Package Length	D1	4.67 BSC		
Exposed Pad Length	D2	3.85	4.00	4.15
Overall Width	E	5.99 BSC		
Molded Package Width	E1	5.74 BSC		
Exposed Pad Width	E2	2.16	2.31	2.46
Contact Width	b	0.35	0.40	0.47
Contact Length	L	0.50	0.60	0.75
Contact-to-Exposed Pad	K	0.20	–	–
Model Draft Angle Top	ϕ	–	–	12°

Notes:

- Pin 1 visual index feature may vary, but must be located within the hatched area.
- Package may have one or more exposed tie bars at ends.
- Dimensioning and tolerancing per ASME Y14.5M.

BSC: Basic Dimension. Theoretically exact value shown without tolerances.

REF: Reference Dimension, usually without tolerance, for information purposes only.

Microchip Technology Drawing C04-113B

TC4423A/TC4424A/TC4425A

8-Lead Plastic Dual In-Line (PA) – 300 mil Body [PDIP]

Note: For the most current package drawings, please see the Microchip Packaging Specification located at <http://www.microchip.com/packaging>

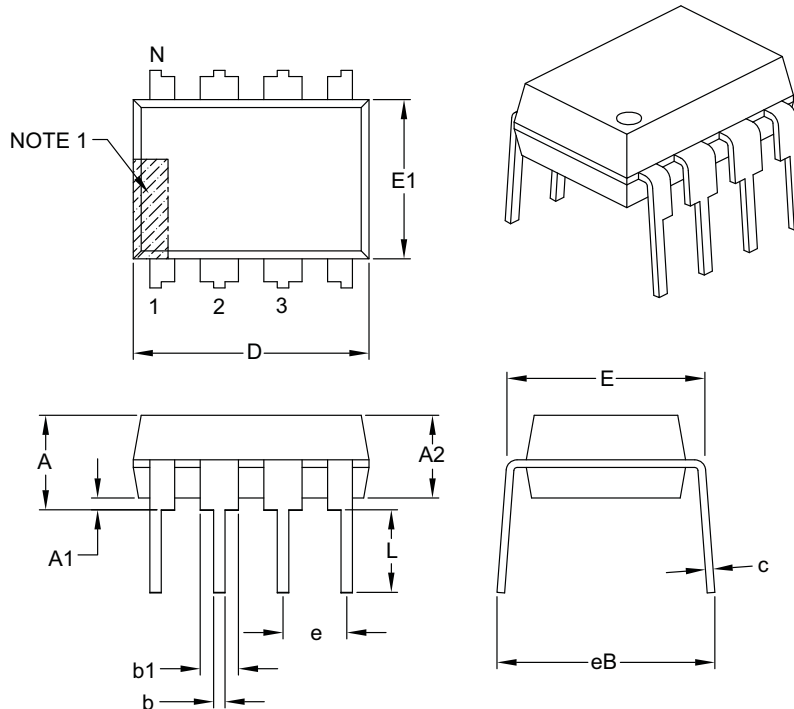

Dimension Limits	Units	INCHES		
		MIN	NOM	MAX
Number of Pins	N	8		
Pitch	e	.100 BSC		
Top to Seating Plane	A	–	–	.210
Molded Package Thickness	A2	.115	.130	.195
Base to Seating Plane	A1	.015	–	–
Shoulder to Shoulder Width	E	.290	.310	.325
Molded Package Width	E1	.240	.250	.280
Overall Length	D	.348	.365	.400
Tip to Seating Plane	L	.115	.130	.150
Lead Thickness	c	.008	.010	.015
Upper Lead Width	b1	.040	.060	.070
Lower Lead Width	b	.014	.018	.022
Overall Row Spacing §	eB	–	–	.430

Notes:

- Pin 1 visual index feature may vary, but must be located with the hatched area.
- § Significant Characteristic.
- Dimensions D and E1 do not include mold flash or protrusions. Mold flash or protrusions shall not exceed .010" per side.
- Dimensioning and tolerancing per ASME Y14.5M.

BSC: Basic Dimension. Theoretically exact value shown without tolerances.

Microchip Technology Drawing C04-018B

TC4423A/TC4424A/TC4425A

8-Lead Plastic Small Outline (OA) – Narrow, 3.90 mm Body [SOIC]

Note: For the most current package drawings, please see the Microchip Packaging Specification located at <http://www.microchip.com/packaging>

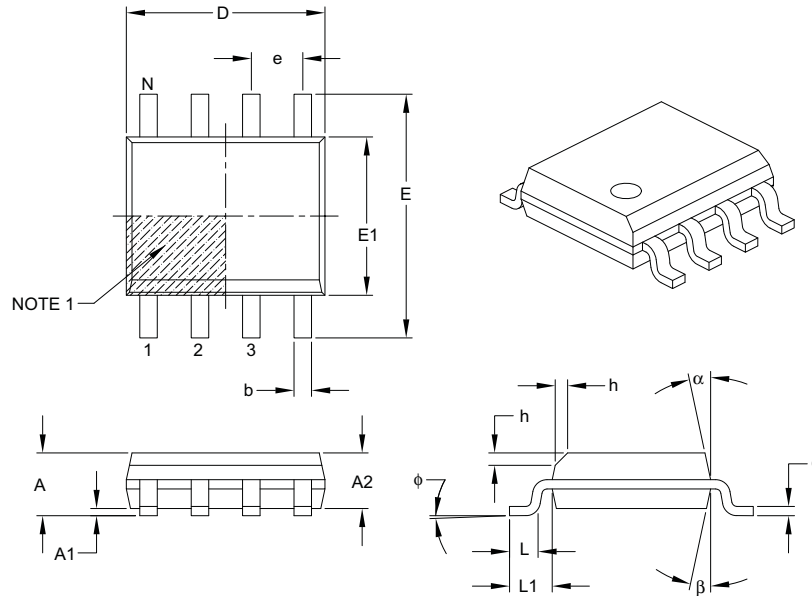

		Units	MILLIMETERS		
Dimension Limits			MIN	NOM	MAX
Number of Pins	N		8		
Pitch	e		1.27 BSC		
Overall Height	A		–	–	1.75
Molded Package Thickness	A2		1.25	–	–
Standoff §	A1		0.10	–	0.25
Overall Width	E		6.00 BSC		
Molded Package Width	E1		3.90 BSC		
Overall Length	D		4.90 BSC		
Chamfer (optional)	h		0.25	–	0.50
Foot Length	L		0.40	–	1.27
Footprint	L1		1.04 REF		
Foot Angle	ϕ		0°	–	8°
Lead Thickness	c		0.17	–	0.25
Lead Width	b		0.31	–	0.51
Mold Draft Angle Top	α		5°	–	15°
Mold Draft Angle Bottom	β		5°	–	15°

Notes:

- Pin 1 visual index feature may vary, but must be located within the hatched area.
- § Significant Characteristic.
- Dimensions D and E1 do not include mold flash or protrusions. Mold flash or protrusions shall not exceed 0.15 mm per side.
- Dimensioning and tolerancing per ASME Y14.5M.

BSC: Basic Dimension. Theoretically exact value shown without tolerances.

REF: Reference Dimension, usually without tolerance, for information purposes only.

Microchip Technology Drawing C04-057B

TC4423A/TC4424A/TC4425A

16-Lead Plastic Small Outline (OE) – Wide, 7.50 mm Body [SOIC]

Note: For the most current package drawings, please see the Microchip Packaging Specification located at <http://www.microchip.com/packaging>

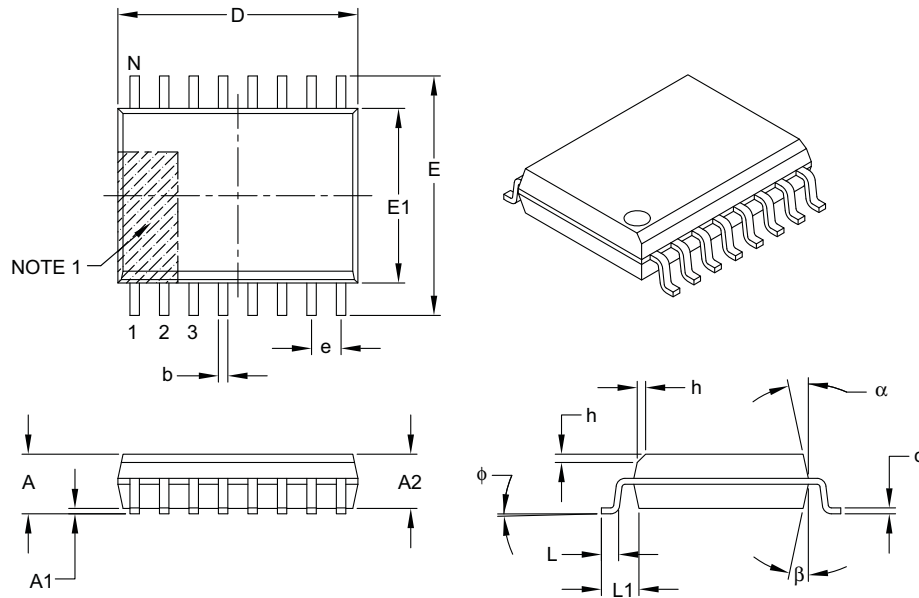

Dimension Limits	Units	MILLIMETERS		
		MIN	NOM	MAX
Number of Pins	N	16		
Pitch	e	1.27 BSC		
Overall Height	A	–	–	2.65
Molded Package Thickness	A2	2.05	–	–
Standoff §	A1	0.10	–	0.30
Overall Width	E	10.30 BSC		
Molded Package Width	E1	7.50 BSC		
Overall Length	D	10.30 BSC		
Chamfer (optional)	h	0.25	–	0.75
Foot Length	L	0.40	–	1.27
Footprint	L1	1.40 REF		
Foot Angle	ϕ	0°	–	8°
Lead Thickness	c	0.20	–	0.33
Lead Width	b	0.31	–	0.51
Mold Draft Angle Top	α	5°	–	15°
Mold Draft Angle Bottom	β	5°	–	15°

Notes:

- Pin 1 visual index feature may vary, but must be located within the hatched area.
- § Significant Characteristic.
- Dimensions D and E1 do not include mold flash or protrusions. Mold flash or protrusions shall not exceed 0.15 mm per side.
- Dimensioning and tolerancing per ASME Y14.5M.

BSC: Basic Dimension. Theoretically exact value shown without tolerances.

REF: Reference Dimension, usually without tolerance, for information purposes only.

Microchip Technology Drawing C04-102B

TC4423A/TC4424A/TC4425A

NOTES:

APPENDIX A: REVISION HISTORY

Revision B (April 2007)

- Correct numerous errors throughout document.
- Page 3: Added Package Power Dissipation information about DC Characteristic Table.
- Page 3: Added Note 3 to DC Characteristic Table.
- Page 4: Changed Thermal Resistance for 8L-PDIP device from 125 to 84.6.
Changed Thermal Resistance for 8L-SOIC from 155 to 163.
- Page 12: Updated Package Outline Drawing.
- Page 13: Updated Package Outline Drawing.
- Page 14: Updated Package Outline Drawing.
- Page 15: Added 16-Lead SOIC Package Outline Drawing
- Page 17: Updated Revision History.

Revision A (June 2006)

- Original Release of this Document.

TC4423A/TC4424A/TC4425A

NOTES:

TC4423A/TC4424A/TC4425A

PRODUCT IDENTIFICATION SYSTEM

To order or obtain information, e.g., on pricing or delivery, refer to the factory or the listed sales office.

<u>PART NO.</u>	<u>X</u>	<u>XX</u>	<u>XXX</u>	Examples:
Device	Temperature Range	Package	Tape & Reel	
<p>Device: TC4423A: 3A Dual MOSFET Driver, Inverting TC4424A: 3A Dual MOSFET Driver, Non-Inverting TC4425A: 3A Dual MOSFET Driver, Complementary</p> <p>Temperature Range: V = -40°C to +125°C</p> <p>Package: *</p> <p>MF = Dual, Flat, No-Lead (6x5 mm Body), 8-lead MF713 = Dual, Flat, No-Lead (6x5 mm Body), 8-lead (Tape and Reel) OA = Plastic SOIC (150 mil Body), 8-Lead OA713 = Plastic SOIC (150 mil Body), 8-Lead (Tape and Reel) OE = Plastic SOIC (Wide Body), 16-lead OE713 = Plastic SOIC (Wide Body), 16-lead (Tape and Reel) PA = Plastic DIP, (300 mil body), 8-lead</p> <p>* All package offerings are Pb Free (Lead Free)</p>				<p>a) TC4423AVOA: 3A Dual Inverting MOSFET Driver, 8LD SOIC package.</p> <p>b) TC4423AVPA: 3A Dual Inverting MOSFET Driver, 8LD PDIP package.</p> <p>c) TC4423AVMF: 3A Dual Inverting MOSFET Driver, 8LD DFN package.</p> <p>d) TC4423AVOE: 3A Dual Inverting MOSFET Driver, 16LD SOIC package.</p>
				<p>a) TC4424AVOA713: 3A Dual Non-Inverting, MOSFET Driver, 8LD SOIC package, Tape and Reel.</p> <p>b) TC4424AVPA: 3A Dual Non-Inverting, MOSFET Driver, 8LD PDIP package.</p>
				<p>a) TC4425AVOA: 3A Dual Complementary, MOSFET Driver, 8LD SOIC package.</p> <p>b) TC4425AVPA: 3A Dual Complementary, MOSFET Driver, 8LD PDIP package.</p> <p>c) TC4425AVOE713: 3A Dual Complementary, MOSFET Driver, 16LD SOIC package, Tape and Reel.</p>

TC4423A/TC4424A/TC4425A

NOTES:

Note the following details of the code protection feature on Microchip devices:

- Microchip products meet the specification contained in their particular Microchip Data Sheet.
- Microchip believes that its family of products is one of the most secure families of its kind on the market today, when used in the intended manner and under normal conditions.
- There are dishonest and possibly illegal methods used to breach the code protection feature. All of these methods, to our knowledge, require using the Microchip products in a manner outside the operating specifications contained in Microchip's Data Sheets. Most likely, the person doing so is engaged in theft of intellectual property.
- Microchip is willing to work with the customer who is concerned about the integrity of their code.
- Neither Microchip nor any other semiconductor manufacturer can guarantee the security of their code. Code protection does not mean that we are guaranteeing the product as “unbreakable.”

Code protection is constantly evolving. We at Microchip are committed to continuously improving the code protection features of our products. Attempts to break Microchip's code protection feature may be a violation of the Digital Millennium Copyright Act. If such acts allow unauthorized access to your software or other copyrighted work, you may have a right to sue for relief under that Act.

Information contained in this publication regarding device applications and the like is provided only for your convenience and may be superseded by updates. It is your responsibility to ensure that your application meets with your specifications. MICROCHIP MAKES NO REPRESENTATIONS OR WARRANTIES OF ANY KIND WHETHER EXPRESS OR IMPLIED, WRITTEN OR ORAL, STATUTORY OR OTHERWISE, RELATED TO THE INFORMATION, INCLUDING BUT NOT LIMITED TO ITS CONDITION, QUALITY, PERFORMANCE, MERCHANTABILITY OR FITNESS FOR PURPOSE. Microchip disclaims all liability arising from this information and its use. Use of Microchip devices in life support and/or safety applications is entirely at the buyer's risk, and the buyer agrees to defend, indemnify and hold harmless Microchip from any and all damages, claims, suits, or expenses resulting from such use. No licenses are conveyed, implicitly or otherwise, under any Microchip intellectual property rights.

Trademarks

The Microchip name and logo, the Microchip logo, Accuron, dsPIC, KEELOQ, KEELOQ logo, microID, MPLAB, PIC, PICmicro, PICSTART, PRO MATE, PowerSmart, rPIC, and SmartShunt are registered trademarks of Microchip Technology Incorporated in the U.S.A. and other countries.

AmpLab, FilterLab, Linear Active Thermistor, Migratable Memory, MXDEV, MXLAB, PS logo, SEEVAL, SmartSensor and The Embedded Control Solutions Company are registered trademarks of Microchip Technology Incorporated in the U.S.A.

Analog-for-the-Digital Age, Application Maestro, CodeGuard, dsPICDEM, dsPICDEM.net, dsPICworks, ECAN, ECONOMONITOR, FanSense, FlexROM, fuzzyLAB, In-Circuit Serial Programming, ICSP, ICEPIC, Mindi, MiWi, MPASM, MPLAB Certified logo, MPLIB, MPLINK, PICkit, PICDEM, PICDEM.net, PICLAB, PICtail, PowerCal, PowerInfo, PowerMate, PowerTool, REAL ICE, rLAB, rfPICDEM, Select Mode, Smart Serial, SmartTel, Total Endurance, UNI/O, WiperLock and ZENA are trademarks of Microchip Technology Incorporated in the U.S.A. and other countries.

SQTP is a service mark of Microchip Technology Incorporated in the U.S.A.

All other trademarks mentioned herein are property of their respective companies.

© 2007, Microchip Technology Incorporated, Printed in the U.S.A., All Rights Reserved.

 Printed on recycled paper.

QUALITY MANAGEMENT SYSTEM
CERTIFIED BY DNV
== ISO/TS 16949:2002 ==

Microchip received ISO/TS-16949:2002 certification for its worldwide headquarters, design and wafer fabrication facilities in Chandler and Tempe, Arizona, Gresham, Oregon and Mountain View, California. The Company's quality system processes and procedures are for its PIC[®] MCUs and dsPIC[®] DSCs, KEELOQ[®] code hopping devices, Serial EEPROMs, microperipherals, nonvolatile memory and analog products. In addition, Microchip's quality system for the design and manufacture of development systems is ISO 9001:2000 certified.



WORLDWIDE SALES AND SERVICE

AMERICAS

Corporate Office
2355 West Chandler Blvd.
Chandler, AZ 85224-6199
Tel: 480-792-7200
Fax: 480-792-7277
Technical Support:
<http://support.microchip.com>
Web Address:
www.microchip.com

Atlanta

Duluth, GA
Tel: 678-957-9614
Fax: 678-957-1455

Boston

Westborough, MA
Tel: 774-760-0087
Fax: 774-760-0088

Chicago

Itasca, IL
Tel: 630-285-0071
Fax: 630-285-0075

Dallas

Addison, TX
Tel: 972-818-7423
Fax: 972-818-2924

Detroit

Farmington Hills, MI
Tel: 248-538-2250
Fax: 248-538-2260

Kokomo

Kokomo, IN
Tel: 765-864-8360
Fax: 765-864-8387

Los Angeles

Mission Viejo, CA
Tel: 949-462-9523
Fax: 949-462-9608

Santa Clara

Santa Clara, CA
Tel: 408-961-6444
Fax: 408-961-6445

Toronto

Mississauga, Ontario,
Canada
Tel: 905-673-0699
Fax: 905-673-6509

ASIA/PACIFIC

Asia Pacific Office
Suites 3707-14, 37th Floor
Tower 6, The Gateway
Harbour City, Kowloon
Hong Kong
Tel: 852-2401-1200
Fax: 852-2401-3431

Australia - Sydney
Tel: 61-2-9868-6733
Fax: 61-2-9868-6755

China - Beijing
Tel: 86-10-8528-2100
Fax: 86-10-8528-2104

China - Chengdu
Tel: 86-28-8665-5511
Fax: 86-28-8665-7889

China - Fuzhou
Tel: 86-591-8750-3506
Fax: 86-591-8750-3521

China - Hong Kong SAR
Tel: 852-2401-1200
Fax: 852-2401-3431

China - Qingdao
Tel: 86-532-8502-7355
Fax: 86-532-8502-7205

China - Shanghai
Tel: 86-21-5407-5533
Fax: 86-21-5407-5066

China - Shenyang
Tel: 86-24-2334-2829
Fax: 86-24-2334-2393

China - Shenzhen
Tel: 86-755-8203-2660
Fax: 86-755-8203-1760

China - Shunde
Tel: 86-757-2839-5507
Fax: 86-757-2839-5571

China - Wuhan
Tel: 86-27-5980-5300
Fax: 86-27-5980-5118

China - Xian
Tel: 86-29-8833-7250
Fax: 86-29-8833-7256

ASIA/PACIFIC

India - Bangalore
Tel: 91-80-4182-8400
Fax: 91-80-4182-8422

India - New Delhi
Tel: 91-11-4160-8631
Fax: 91-11-4160-8632

India - Pune
Tel: 91-20-2566-1512
Fax: 91-20-2566-1513

Japan - Yokohama
Tel: 81-45-471- 6166
Fax: 81-45-471-6122

Korea - Gumi
Tel: 82-54-473-4301
Fax: 82-54-473-4302

Korea - Seoul
Tel: 82-2-554-7200
Fax: 82-2-558-5932 or
82-2-558-5934

Malaysia - Penang
Tel: 60-4-646-8870
Fax: 60-4-646-5086

Philippines - Manila
Tel: 63-2-634-9065
Fax: 63-2-634-9069

Singapore
Tel: 65-6334-8870
Fax: 65-6334-8850

Taiwan - Hsin Chu
Tel: 886-3-572-9526
Fax: 886-3-572-6459

Taiwan - Kaohsiung
Tel: 886-7-536-4818
Fax: 886-7-536-4803

Taiwan - Taipei
Tel: 886-2-2500-6610
Fax: 886-2-2508-0102

Thailand - Bangkok
Tel: 66-2-694-1351
Fax: 66-2-694-1350

EUROPE

Austria - Wels
Tel: 43-7242-2244-39
Fax: 43-7242-2244-393

Denmark - Copenhagen
Tel: 45-4450-2828
Fax: 45-4485-2829

France - Paris
Tel: 33-1-69-53-63-20
Fax: 33-1-69-30-90-79

Germany - Munich
Tel: 49-89-627-144-0
Fax: 49-89-627-144-44

Italy - Milan
Tel: 39-0331-742611
Fax: 39-0331-466781

Netherlands - Drunen
Tel: 31-416-690399
Fax: 31-416-690340

Spain - Madrid
Tel: 34-91-708-08-90
Fax: 34-91-708-08-91

UK - Wokingham
Tel: 44-118-921-5869
Fax: 44-118-921-5820

12/08/06

X-ON Electronics

Largest Supplier of Electrical and Electronic Components

Click to view similar products for [Gate Drivers](#) category:

Click to view products by [Microchip](#) manufacturer:

Other Similar products are found below :

[89076GBEST](#) [00053P0231](#) [56956](#) [57.404.7355.5](#) [LT4936](#) [57.904.0755.0](#) [5882900001](#) [00600P0005](#) [00-9050-LRPP](#) [00-9090-RDPP](#)
[5951900000](#) [01-1003W-10/32-15](#) [0131700000](#) [00-2240](#) [LTP70N06](#) [LVP640](#) [5J0-1000LG-SIL](#) [LY1D-2-5S-AC120](#) [LY2-US-AC240](#) [LY3-](#)
[UA-DC24](#) [00576P0020](#) [00600P0010](#) [LZN4-UA-DC12](#) [LZNQ2M-US-DC5](#) [LZNQ2-US-DC12](#) [LZP40N10](#) [00-8196-RDPP](#) [00-8274-RDPP](#)
[00-8275-RDNP](#) [00-8722-RDPP](#) [00-8728-WHPP](#) [00-8869-RDPP](#) [00-9051-RDPP](#) [00-9091-LRPP](#) [00-9291-RDPP](#) [0207100000](#) [0207400000](#)
[01312](#) [0134220000](#) [60713816](#) [M15730061](#) [61161-90](#) [61278-0020](#) [6131-204-23149P](#) [6131-205-17149P](#) [6131-209-15149P](#) [6131-218-17149P](#)
[6131-220-21149P](#) [6131-260-2358P](#) [6131-265-11149P](#)