



Micro Commercial Components

Micro Commercial Components
20736 Marilla Street Chatsworth
CA 91311
Phone: (818) 701-4933
Fax: (818) 701-4939

FS1A-L THRU FS1M-L

Features

- Halogen free available upon request by adding suffix "-HF"
- Epoxy meets UL 94 V-0 flammability rating
- Moisture Sensitivity Level 1
- Lead Free Finish/Rohs Compliant (Note1) ("P" Suffix designates Compliant. See ordering information)
- Easy Pick And Place
- High Temp Soldering: 260°C for 10 Seconds At Terminals
- Fast Recovery Times For High Efficiency

Maximum Ratings

- Operating Temperature: -50°C to +150°C
- Storage Temperature: -50°C to +150°C
- Maximum Thermal Resistance; 15°C/W Junction To Lead

MCC Catalog Number	Device Marking	Maximum Recurrent Peak Reverse Voltage	Maximum RMS Voltage	Maximum DC Blocking Voltage
FS1A-L	FS1A	50V	35V	50V
FS1B-L	FS1B	100V	70V	100V
FS1D-L	FS1D	200V	140V	200V
FS1G-L	FS1G	400V	280V	400V
FS1J-L	FS1J	600V	420V	600V
FS1K-L	FS1K	800V	560V	800V
FS1M-L	FS1M	1000V	700V	1000V

1 Amp Fast Recovery Silicon Rectifier 50 to 1000 Volts

DO-214AC (SMA) (LEAD FRAME)

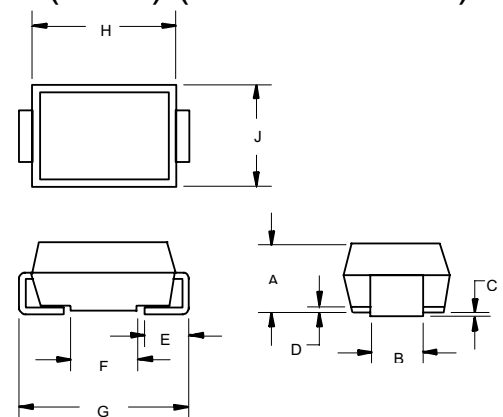

DIM	INCHES		MM		NOTE
	MIN	MAX	MIN	MAX	
A	.079	.096	2.00	2.44	
B	.050	.064	1.27	1.63	
C	.002	.008	.05	.20	
D	---	.02	---	.51	
E	.030	.060	.76	1.52	
F	.065	.091	1.65	2.32	
G	.189	.220	4.80	5.59	
H	.157	.181	4.00	4.60	
J	.090	.115	2.25	2.92	

Electrical Characteristics @ 25°C Unless Otherwise Specified

Average Forward current	$I_{F(AV)}$	1.0A	$T_a = 90^\circ\text{C}$
Peak Forward Surge Current	I_{FSM}	30A	8.3ms, half sine
Maximum Instantaneous Forward Voltage	V_F	1.30V	$I_{FM} = 1.0A$; $T_J = 25^\circ\text{C}^*$
Maximum DC Reverse Current At Rated DC Blocking Voltage	I_R	5 μA 200 μA	$T_J = 25^\circ\text{C}$ $T_J = 125^\circ\text{C}$
Maximum Reverse Recovery Time FS1A-L-G-L FS1J-L FS1K-L-M-L	T_{rr}	150ns 250ns 500ns	$I_F=0.5A, I_R=1.0A,$ $I_{rr}=0.25A$
Typical Junction Capacitance	C_J	15pF	Measured at 1.0MHz, $V_R=4.0V$

*Pulse test: Pulse width 200 μsec , Duty cycle 2%
Notes: 1.High Temperature Solder Exemption Applied, see EU Directive Annex Notes 7.

SUGGESTED SOLDER PAD LAYOUT

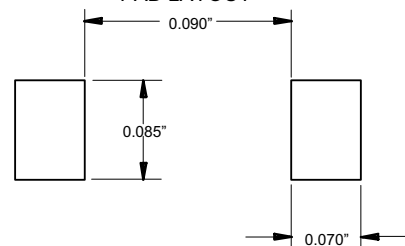

FS1A-L thru FS1M-L

Figure 1
Typical Forward Characteristics

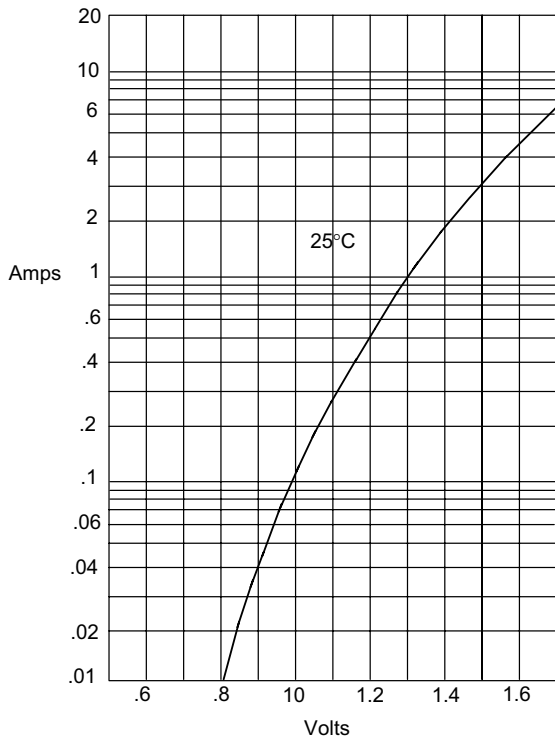

Instantaneous Forward Current - Amperes *versus*
Instantaneous Forward Voltage - Volts

Figure 2
Forward Derating Curve

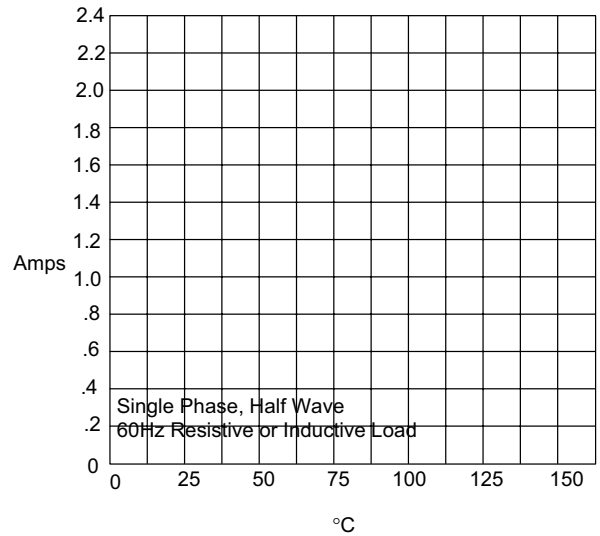

Average Forward Rectified Current - Amperes *versus*
Ambient Temperature - °C

Figure 3
Junction Capacitance

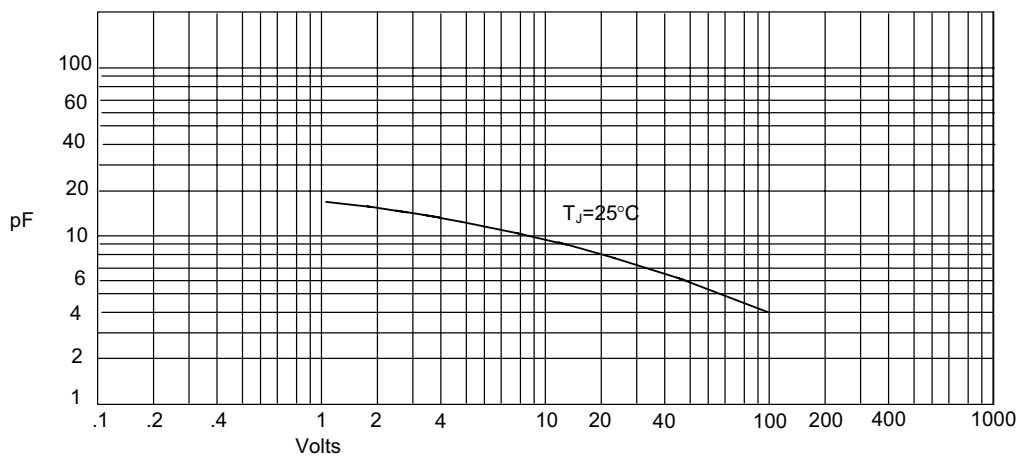

Junction Capacitance - pF *versus*
Reverse Voltage - Volts

FS1A-L thru FS1M-L

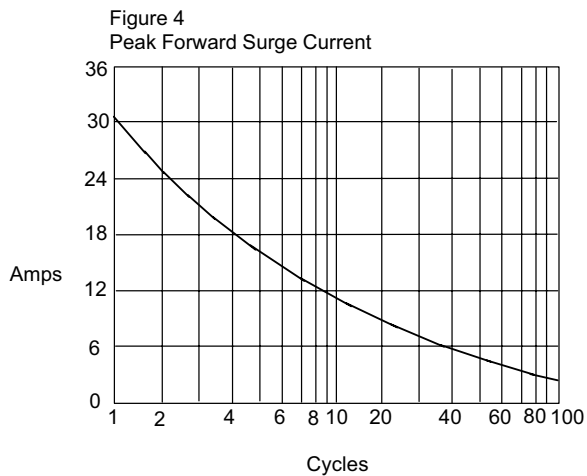

Peak Forward Surge Current - Amperes *versus* Number Of Cycles At 60Hz - Cycles

Figure 5
Reverse Recovery Time Characteristic And Test Circuit Diagram

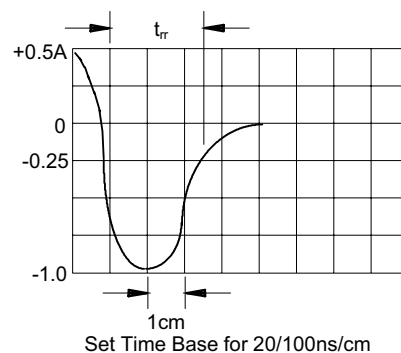
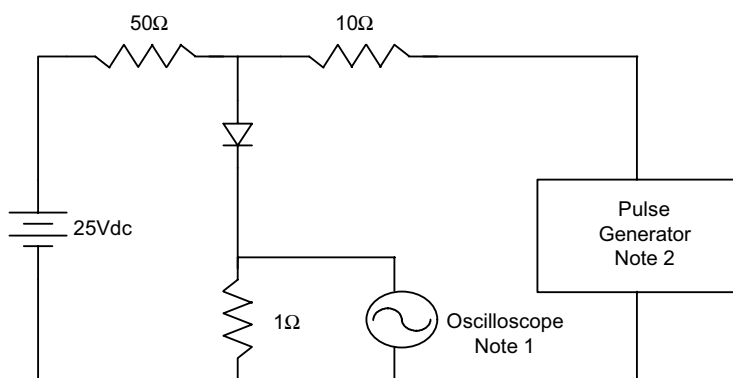

- Notes:
1. Rise Time = 7ns max.
Input impedance = 1 megohm, 22pF
 2. Rise Time = 10ns max.
Source impedance = 50 ohms
 3. Resistors are non-inductive



Micro Commercial Components

Ordering Information :

Device	Packing
FS1A-LTP~FS1M-LTP	Tape&Reel: 5Kpcs/Reel

Note : Adding "-HF" suffix for halogen free, eg. FS1A-LTP-HF~FS1M-LTP-HF

IMPORTANT NOTICE

Micro Commercial Components Corp. reserves the right to make changes without further notice to any product herein to make corrections, modifications , enhancements , improvements , or other changes . Micro Commercial Components Corp . does not assume any liability arising out of the application or use of any product described herein; neither does it convey any license under its patent rights ,nor the rights of others . The user of products in such applications shall assume all risks of such use and will agree to hold Micro Commercial Components Corp . and all the companies whose products are represented on our website, harmless against all damages.

LIFE SUPPORT

MCC's products are not authorized for use as critical components in life support devices or systems without the express written approval of Micro Commercial Components Corporation.

CUSTOMER AWARENESS

Counterfeiting of semiconductor parts is a growing problem in the industry. Micro Commercial Components (MCC) is taking strong measures to protect ourselves and our customers from the proliferation of counterfeit parts. MCC strongly encourages customers to purchase MCC parts either directly from MCC or from Authorized MCC Distributors who are listed by country on our web page cited below. Products customers buy either from MCC directly or from Authorized MCC Distributors are genuine parts, have full traceability, meet MCC's quality standards for handling and storage. MCC will not provide any warranty coverage or other assistance for parts bought from Unauthorized Sources. MCC is committed to combat this global problem and encourage our customers to do their part in stopping this practice by buying direct or from authorized distributors.

www.mccsemi.com

X-ON Electronics

Largest Supplier of Electrical and Electronic Components

Click to view similar products for [Rectifiers](#) category:

Click to view products by [Micro Commercial Components \(MCC\)](#) manufacturer:

Other Similar products are found below :

[70HFR40](#) [FR105 R0](#) [RL252-TP](#) [1N5397](#) [1N4005-TR](#) [1N4007-BP](#) [UFS120Je3/TR13](#) [20ETS12S](#) [RRE02VS6SGTR](#) [MS306](#) [A1N5404G-G](#)
[CRF02\(T5L,TEMQ\)](#) [ACGRB207-HF](#) [CLH07\(TE16L,Q\)](#) [CLH03\(TE16L,Q\)](#) [1N5395-TP](#) [UES1302](#) [ACGRC307-HF](#) [ACEFC304-HF](#) [DZ-](#)
[1380](#) [85HFR60](#) [40HFR60](#) [70HF120](#) [85HFR80](#) [SCF7500](#) [SM100](#) [ACGRA4001-HF](#) [SKN70/08](#) [NTE5819](#) [NTE5827](#) [NTE5828](#) [NTE5911](#)
[NTE5915](#) [NTE6104](#) [NTE6163](#) [NTE6164](#) [NTE6165](#) [NTE6364](#) [TSD3G](#) [SET130312](#) [NRVUS110VT3G](#) [UES1106](#) [UES1306](#)
[NRVUS240VT3G](#) [D5FE60-5063](#) [R4000GPS-TP](#) [D4015L56TP](#) [UES1306HR2](#) [FX20K120](#) [D20XB60-7101](#)