

Features

- Lead Free Finish/RoHS Compliant (Note 1) ("P" Suffix Designates Compliant. See Ordering Information)
- Halogen Free. "Green" Device (Note 2)
- Epoxy Meets UL 94 V-0 Flammability Rating
- Moisture Sensitivity Level 1

Maximum Ratings

- Operating Junction Temperature Range: -55°C to +150°C
- Storage Temperature Range: -55°C to +150°C
- Typical Thermal Resistance: 20°C/W Junction to Lead
- Typical Thermal Resistance: 80°C/W Junction to Ambient

MCC Part Number	Device Marking	Maximum Recurrent Peak Reverse Voltage	Maximum RMS Voltage	Maximum DC Blocking Voltage
LMB12S	LB12S	20V	14V	20V
LMB14S	LB14S	40V	28V	40V
LMB16S	LB16S	60V	42V	60V
LMB18S	LB18S	80V	56V	80V
LMB110S	LB110S	100V	70V	100V

Electrical Characteristics @ 25°C Unless Otherwise Specified

Average Rectified Output Current	$I_{F(AV)}$	1.0A	$T_A=80^\circ\text{C}$ (Note 3) $T_A=40^\circ\text{C}$ (Note 4)
Peak Forward Surge Current	I_{FSM}	30A	8.3ms, Half Sine
Maximum Instantaneous Forward Voltage LMB12S~LMB14S LMB16S LMB18S~LMB110S	V_F	0.55V 0.65V 0.85V	$I_{FM} = 0.5A$; $T_A = 25^\circ\text{C}$
Maximum DC Reverse Current at Rated DC Blocking Voltage	I_R	0.1mA	$T_A = 25^\circ\text{C}$
Typical Junction Capacitance	C_J	50pF	Measured at 1.0MHz, $V_R=4.0V$

- Note: 1. High Temperature Solder Exemption Applied, See EU Directive Annex Notes 7a.
 2. Halogen free "Green" products are defined as those which contain <900ppm bromine, <900ppm chlorine (<1500ppm total Br + Cl) and <1000ppm antimony compounds.
 3. On Alumina Substrate, See Fig 1.
 4. On Glass-epoxy Substrate, See Fig 1.

1 Amp Surface Mount Schottky Bridge Rectifier 20 to 100 Volts

LMBS-1

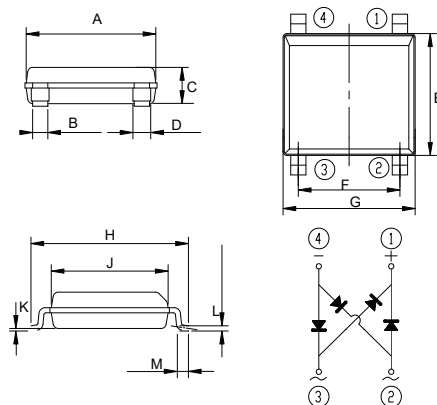

DIM	DIMENSIONS				NOTE
	INCHES		MM		
A	0.197	0.205	4.90	5.20	
B	0.024				0.60
C	---	0.059	---	1.50	
D	0.024	0.032	0.60	0.80	
E	---	0.189	---	4.80	
F	0.150	0.165	3.80	4.20	
G	---	0.209	---	5.30	
H	0.236	0.252	6.00	6.60	
J	0.177	0.185	4.30	4.70	
K	0.0009	0.004	0.02	0.21	
L	0.006	0.012	0.15	0.30	
M	0.017	0.031	0.25	0.80	

Suggested Solder Pad Layout

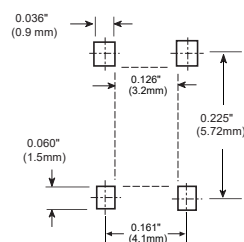

Curve Characteristics

Fig. 1 - Forward Current Derating Curve

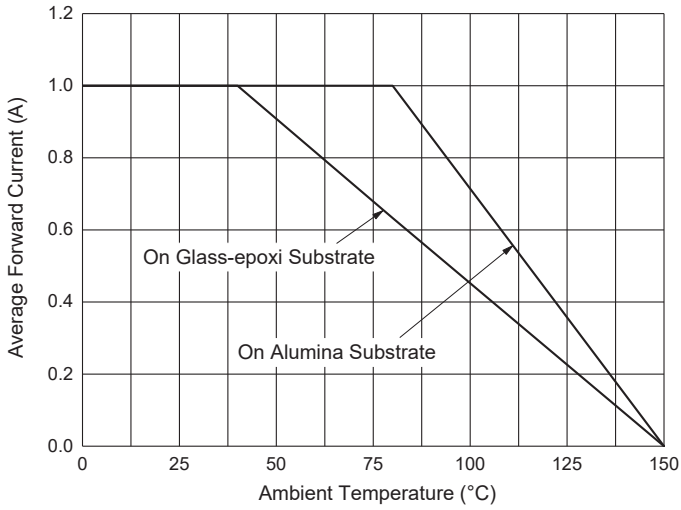

Fig. 2 - Maximum Non-Repetitive Peak Forward Surge Current

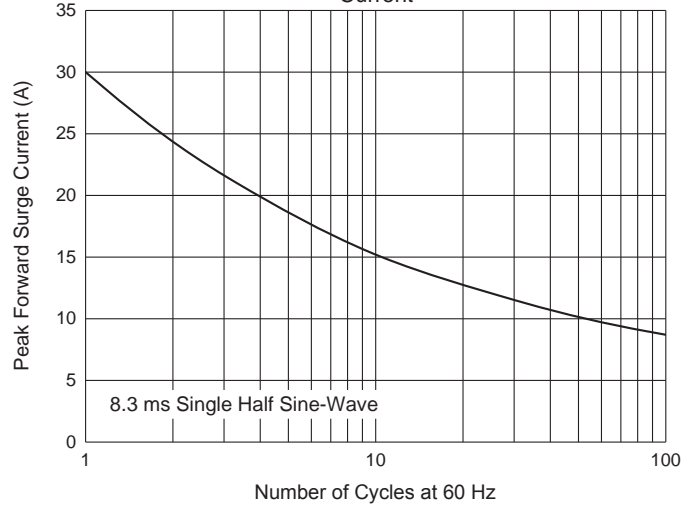

Fig. 3 - Typical Instantaneous Forward Characteristics

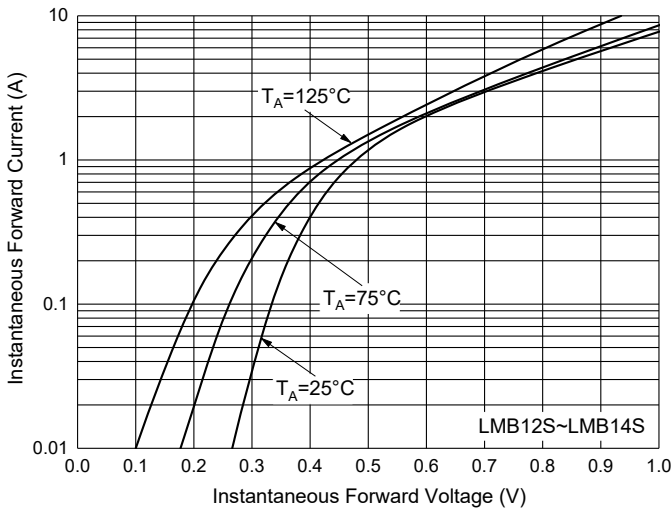

Fig. 4 - Typical Instantaneous Forward Characteristics

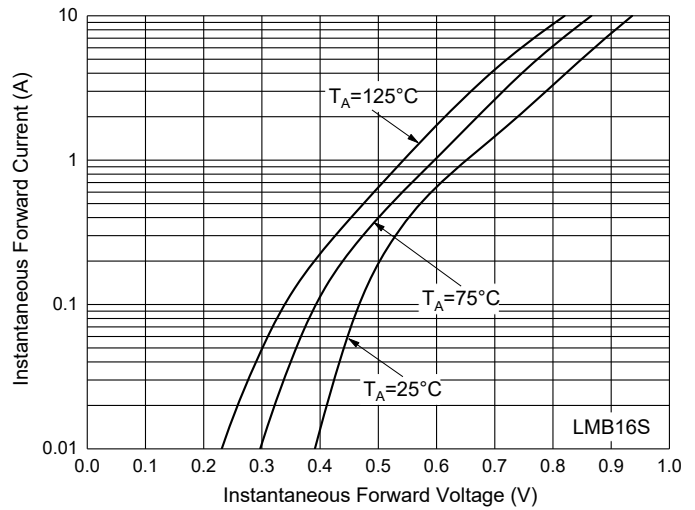

Fig. 5 - Typical Instantaneous Forward Characteristics

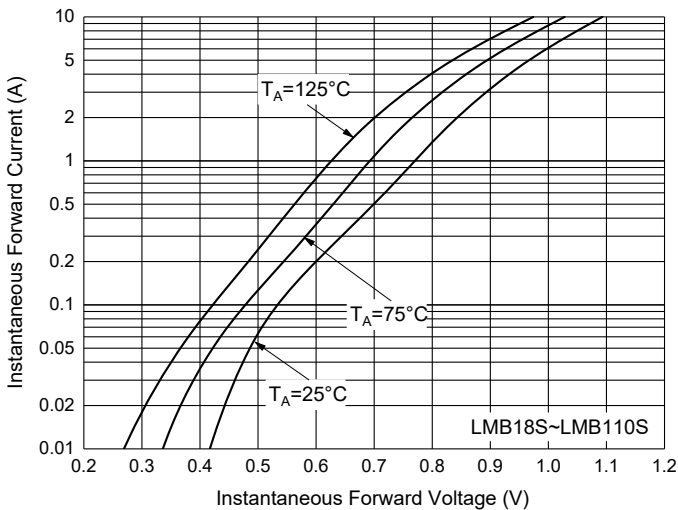
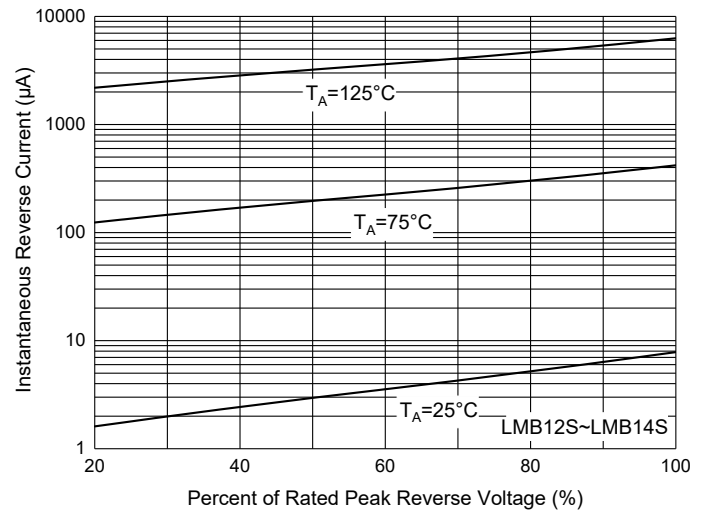

Fig. 6 - Typical Reverse Leakage Characteristics



Curve Characteristics

Fig. 7 - Typical Reverse Leakage Characteristics

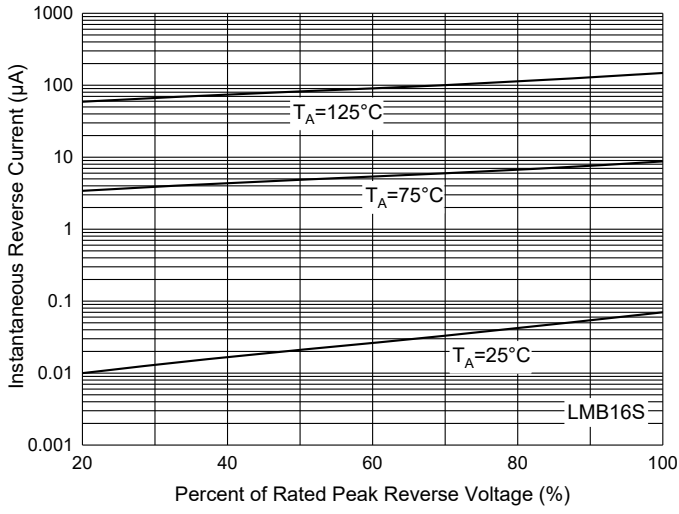
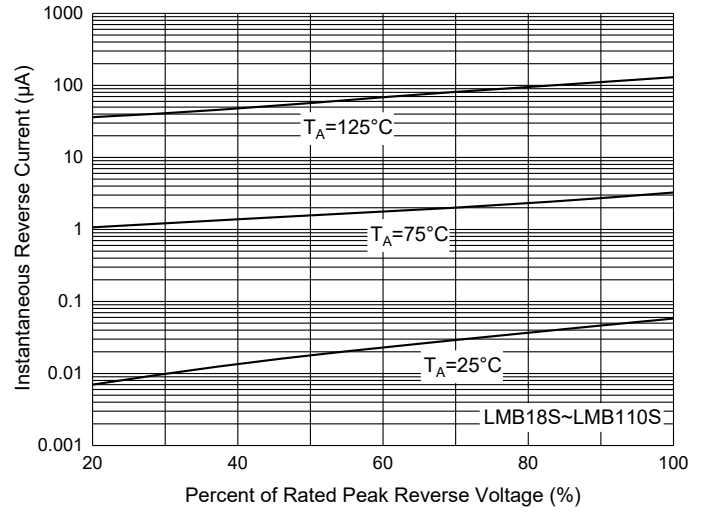

Fig. 8 - Typical Reverse Leakage Characteristics



Ordering Information

Device	Packing
(Part Number)-TP	Tape&Reel;5Kpcs/Reel

*****IMPORTANT NOTICE*****

Micro Commercial Components Corp. reserves the right to make changes without further notice to any product herein to make corrections, modifications , enhancements , improvements , or other changes . **Micro Commercial Components Corp** . does not assume any liability arising out of the application or use of any product described herein; neither does it convey any license under its patent rights ,nor the rights of others . The user of products in such applications shall assume all risks of such use and will agree to hold **Micro Commercial Components Corp** . and all the companies whose products are represented on our website, harmless against all damages. **Micro Commercial Components Corp.** products are sold subject to the general terms and conditions of commercial sale, as published at <https://www.mccsemi.com/Home/TermsAndConditions>.

*****LIFE SUPPORT*****

MCC's products are not authorized for use as critical components in life support devices or systems without the express written approval of Micro Commercial Components Corporation.

*****CUSTOMER AWARENESS*****

Counterfeiting of semiconductor parts is a growing problem in the industry. Micro Commercial Components (MCC) is taking strong measures to protect ourselves and our customers from the proliferation of counterfeit parts. MCC strongly encourages customers to purchase MCC parts either directly from MCC or from Authorized MCC Distributors who are listed by country on our web page cited below. Products customers buy either from MCC directly or from Authorized MCC Distributors are genuine parts, have full traceability, meet MCC's quality standards for handling and storage. **MCC will not provide any warranty coverage or other assistance for parts bought from Unauthorized Sources.** MCC is committed to combat this global problem and encourage our customers to do their part in stopping this practice by buying direct or from authorized distributors.

X-ON Electronics

Largest Supplier of Electrical and Electronic Components

Click to view similar products for [Bridge Rectifiers](#) category:

Click to view products by [Micro Commercial Components \(MCC\)](#) manufacturer:

Other Similar products are found below :

[MB252](#) [MB356G](#) [MB358G](#) [MP358-BP](#) [GBJ1504-BP](#) [GBU10B-BP](#) [GBU15J-BP](#) [GBU15K-BP](#) [GBU4A-BP](#) [GBU4D-BP](#) [GBU6B-E3/45](#)
[GSIB680-E3/45](#) [DB101-BP](#) [DF01](#) [DF10SA-E345](#) [BU1508-E3/45](#) [KBPC50-10S](#) [RS405GL-BP](#) [G5SBA60-E3/51](#) [GBJ1502-BP](#) [GBU10J-BP](#)
[GBU4J-BP](#) [GBU6M](#) [GBU8D-BP](#) [GBU8J-BP](#) [GSIB1520-E3/45](#) [TB102M](#) [MB1510](#) [MB6M-G](#) [MB86](#) [TL401G](#) [MDA920A2](#) [TU602](#) [TU810](#)
[MP501W-BP](#) [MP502-BP](#) [BR1005-BP](#) [BR101-BP](#) [BR84DTP204](#) [BU1010A-E3/51](#) [BU2006-E3/45](#) [BU2008-E3/51](#) [KBPC25-02](#) [VS-](#)
[60MT120KPBF](#) [DB105-BP](#) [DF1510S](#) [VS-40MT160PAPBF](#) [GBU4G-BP](#) [GBJ2506-BP](#) [GBU6B-E3/51](#)