



# UQ1 series

Cubic Ultrasonic Sensor with M18 head



Cubic Ultrasonic Sensor  
with M18 head

## features

- Models with digital and analog output
- Models with IO-Link output
- Working area adjusting by Teach-in button
- Complete protection against electrical damages
- Plastic housing, M12 plug exit



## web contents



- Application notes
- Photos
- Catalogue / Manuals



## code description

UQ 1 A / G 4 - 0 E IO

series	<b>UQ</b>	M18 Ultrasonic Cubic Sensor
function	<b>1</b>	Standard housing
nominal sensing distance Sn	<b>A</b>	40...300 mm
	<b>C</b>	60...800 mm
	<b>D</b>	80...1.200 mm
adjustment	<b>G</b>	Adjustment by Teach-In button
output	<b>4</b>	NPN - NO/NC digital output + 4 ... 20 mA current analogue output
	<b>6</b>	PNP - NO/NC digital output + 4 ... 20 mA current analogue output
	<b>7</b>	PNP - NO/NC digital output + 0 ... 10 V voltage analogue output
	<b>9</b>	NPN - NO/NC digital output + 0 ... 10 V voltage analogue output
housing materials	<b>P</b>	IO-Link output
cable exit / connector	<b>0</b>	Plastic housing
	<b>E</b>	M12 plug cable exit
IO-Link	<b>IO</b>	IO-Link models



Cubic Ultrasonic Sensor  
with M18 head

## available models

digital + analog mixed outputs

output	distance (mm)	adjusting	PNP + 4...20 mA	NPN + 4...20 mA	PNP + 0...10 V	NPN + 0...10 V
direct diffuse	300	yes	UQ1A/G6-0E	UQ1A/G4-0E	UQ1A/G7-0E	UQ1A/G9-0E
	800		UQ1C/G6-0E	UQ1C/G4-0E	UQ1C/G7-0E	UQ1C/G9-0E
	1.200		UQ1D/G6-0E	UQ1D/G4-0E	UQ1D/G7-0E	UQ1D/G9-0E

## available models

single digital output (IO-Link models)

output	distance (mm)	adjusting	IO-Link
direct diffuse	300	yes	UQ1A/GP-0EIO
	800		UQ1C/GP-0EIO
	1.200		UQ1D/GP-0EIO



	UQ1A	UQ1C	UQ1D
nominal sensing distance	300 mm <sup>(1)</sup>	800 mm <sup>(2)</sup>	1.200 mm <sup>(2)</sup>
minimum sensing distance	40 mm	60 mm	80 mm
sensing range	40...300 mm	60...800 mm	80...1.200 mm
beam angle	7° ± 2°	8° ± 2°	
switching frequency	8 Hz	5 Hz	3 Hz
hysteresis	1%		
repeatability	1%		
linearity error	< 1 %		
temperature range	- 20°...+70° C		
temperature compensation	●		
temperature drift of Sr	± 5%		
operating voltage	10...30 V		
max. ripple content	5%		
leakage current	≤ 10 µA @ 30 Vcc		
output voltage drop	≤ 2,2 V (@ IL = 100mA)		
no-load supply current	≤ 35 mA		
output current (digital output)	100 mA		
response time analogue output	≤ 400 ms		
power on delay (digital output)	≤ 400 ms		
short-circuit protection	● (autoreset)		
induction protection	●		
voltage reversal protection	●		
EMC	conforming to EMC Directive, according to EN 60947-5-2		
weight	30 g		
LEDs	green: echo - yellow: output		
protection degree	IP67 (EN 60529)		
housing material	PBT or PA12		
active head material	epoxy glass resin		
storage temperature	- 30°C...+ 80°		

(1) Metallic target 100 x 100 mm (2) Metallic target 200 x 200



## electrical diagrams of the connections

### PNP NO/NC models + analog output

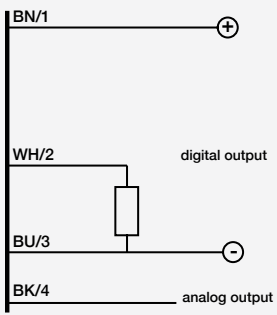

### IO-Link output models

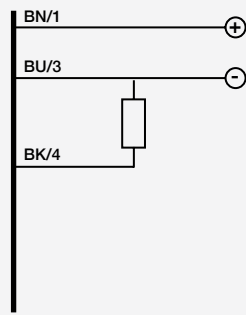

### NPN NO/NC models + analog output

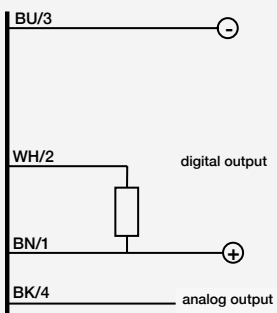

## connectors

### M12

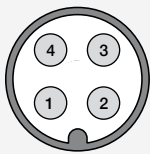



UQ1\*/\*\*-\*\*

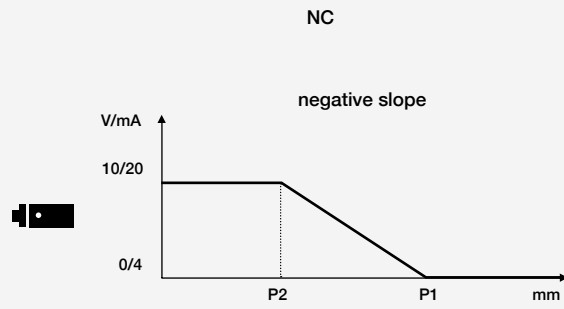
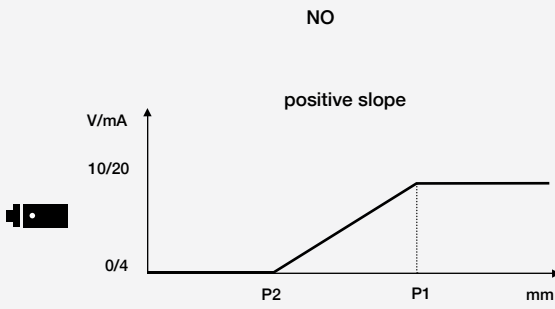
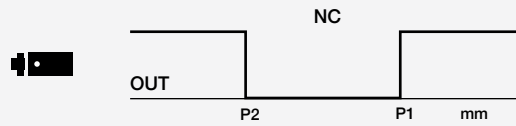
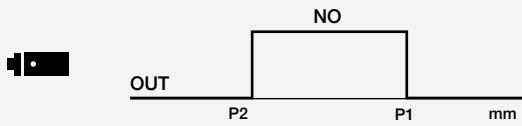

response diagrams

UQ1A/\*\*-\*\*-\*\* parallel displacement

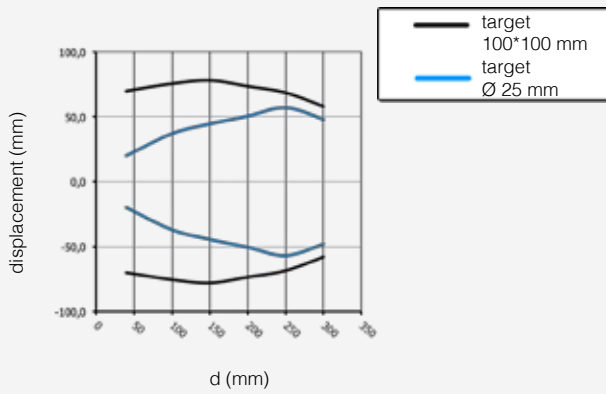

UQ1C/\*\*-\*\*-\*\* parallel displacement

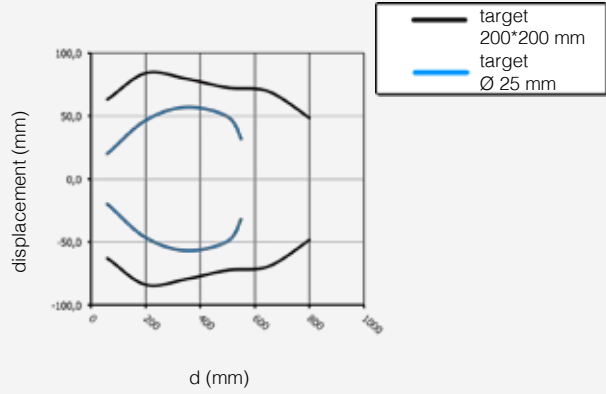

UQ1D/\*\*-\*\*-\*\* parallel displacement

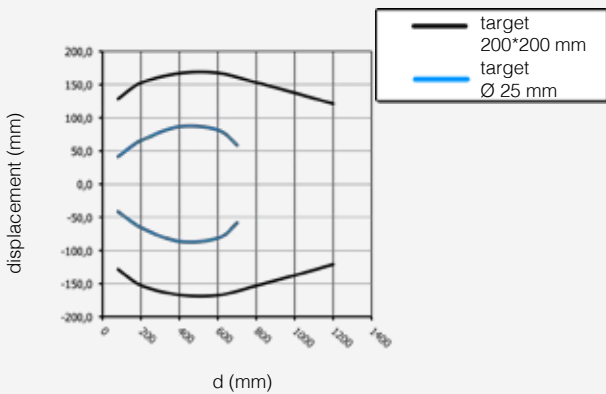



## dimensions (mm)

Cubic Ultrasonic Sensor  
with M18 head

UQ1\*/\*\* - \*\*

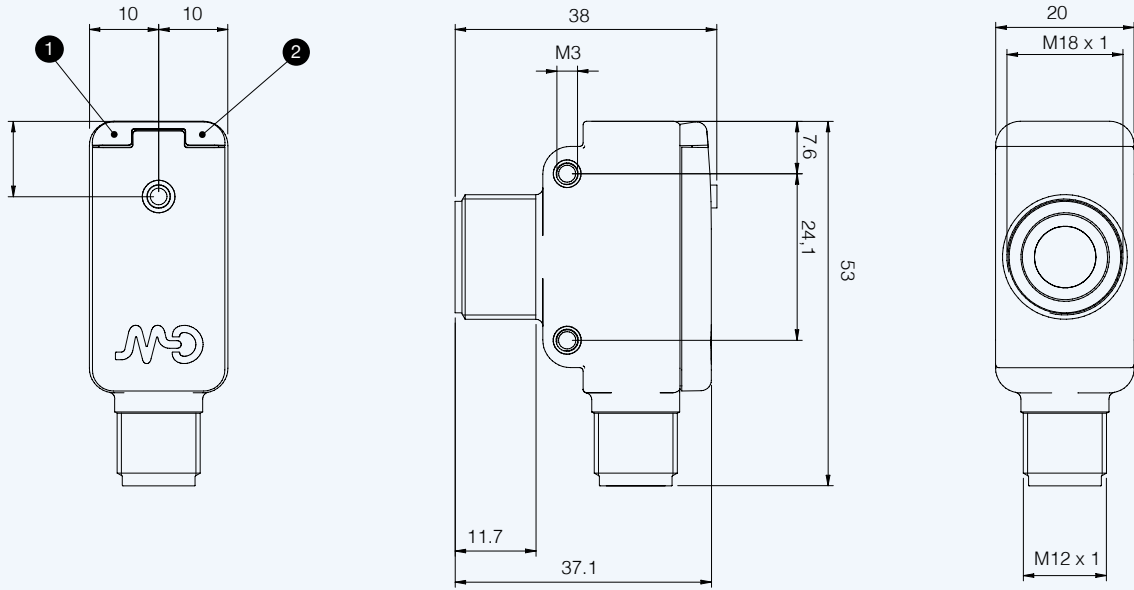

1 green LED

2 yellow LED

## dimensions (mm)

included accessories

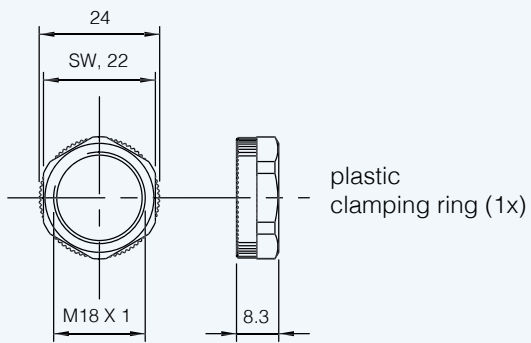

## X-ON Electronics

Largest Supplier of Electrical and Electronic Components

*Click to view similar products for [Proximity Sensors](#) category:*

*Click to view products by [Micro Detectors](#) manufacturer:*

Other Similar products are found below :

[01.001.5653.1](#) [70.340.1028.0](#) [70.360.2428.0](#) [70.364.4828.0](#) [70.810.1053.0](#) [72.360.1628.0](#) [73.363.6428.0](#) [8027AL20NL2CPXX](#) [FYCC8E1-2](#)  
[9221350022](#) [922AA2W-A9P-L](#) [PLS2](#) [GL-12F-C2.5X10\(LOT3\)](#) [972AB2XM-A3N-L](#) [972AB3XM-A3P-L](#) [PS3251](#) [980659-1](#) [QT-12](#) [E2E2-](#)  
[X5M41-M4](#) [E2E-X14MD1-G](#) [E2E-X2D1-G](#) [E2EX2ME2N](#) [E2EX3D1SM1N](#) [E2E-X4MD1-G](#) [E2E-X5E1-5M-N](#) [E2E-X5Y2-N](#) [E2E-X7D1-](#)  
[M1J-T-0.3M-N](#) [E2FMX1R5D12M](#) [E2K-F10MC1](#) [5M](#) [EH-302](#) [EI3010TBOP](#) [EI5515NPAP](#) [MS605AU](#) [EP175-32000](#) [IFRM04N35B1/L](#)  
[IFRM04P1513/S35L](#) [IFRM06P1703/S35L](#) [IFRM08P1501/S35L](#) [IFRM12N17G3/L](#) [IFRM12P17G3/L](#) [IFRM12P3502/L](#) [IFRM12P37G1/S14L](#)  
[ILFK12E9189/I02](#) [ILFK12E9193/I02](#) [IMM2582C](#) [OISN-013](#) [25.161.3253.0](#) [25.332.0653.1](#) [25.352.0653.0](#) [25.352.0753.0](#)