

SCHOTTKY DIODES

FEATURES

- Extremely Fast Switching Speed

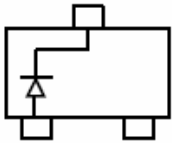
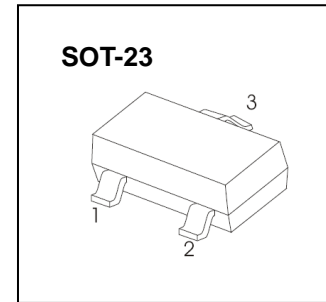

BAT54 MARKING: KL1

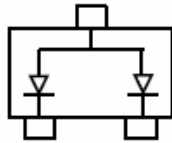

BAT54A MARKING: KL2

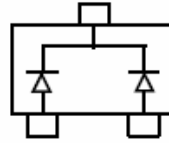

BAT54C MARKING: KL3

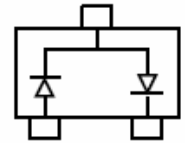

BAT54S MARKING: KL4

Maximum Ratings @T_A=25°C

| Parameter | Symbol | Limits | Unit |
|--------------------------------------|------------------|---------|------|
| Peak Repetitive Peak reverse voltage | V _{RRM} | 30 | V |
| Working Peak Reverse Voltage | V _{RWM} | | |
| DC Blocking Voltage | V _R | | |
| Forward Continuous Current | I _{FM} | 200 | mA |
| Power Dissipation | P _D | 200 | mW |
| Storage temperature | T _{STG} | -55-150 | °C |

Electrical Characteristics @T_A=25°C

| Parameter | Symbol | Min. | Typ. | Max. | Unit | Conditions |
|---------------------------|--------------------|------|------|------|------|-----------------------------------------------------------------------------------------------------|
| Reverse Breakdown Voltage | V _{(BR)R} | 30 | | | V | I _R =100μA |
| Forward voltage | V _{F1} | | | 0.24 | V | I _F =0.1mA |
| | V _{F2} | | | 0.32 | V | I _F =1mA |
| | V _{F3} | | | 0.40 | V | I _F =10mA |
| | V _{F4} | | | 0.50 | V | I _F =30mA |
| | V _{F5} | | | 1 | V | I _F =100mA |
| Reverse current | I _R | | | 2 | μA | V _R =25V |
| Diode Capacitance | C _D | | | 10 | pF | V _R =1V, f=1MHz |
| Reverse Recovery Time | t _{rr} | | | 5 | nS | I _F =I _R =10mA I _{rr} =0.1X I _R , R _L =100Ω |



Typical Characteristics

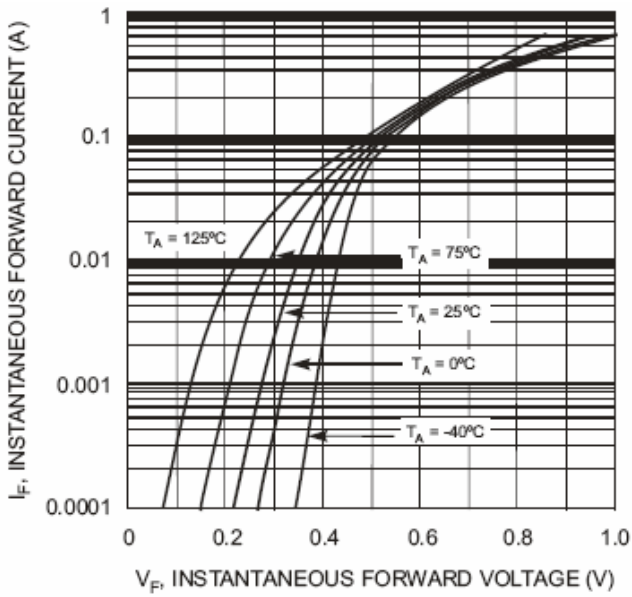

Fig. 1 Forward Characteristics

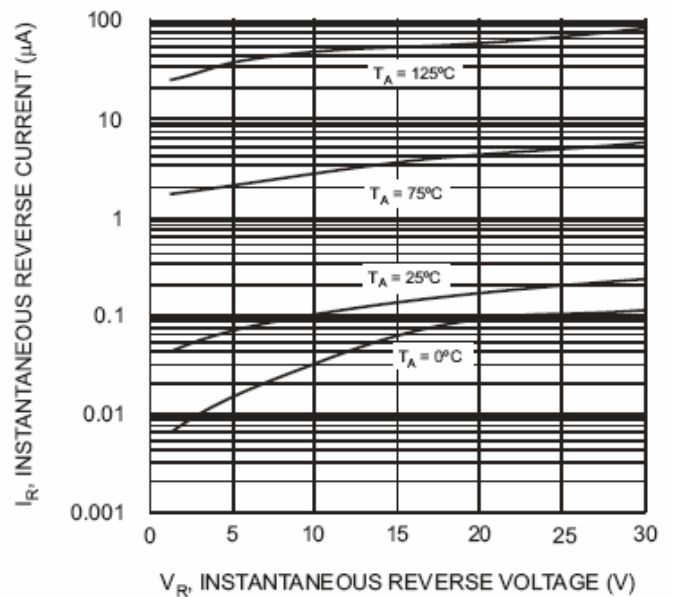

Fig. 2 Typical Reverse Characteristics

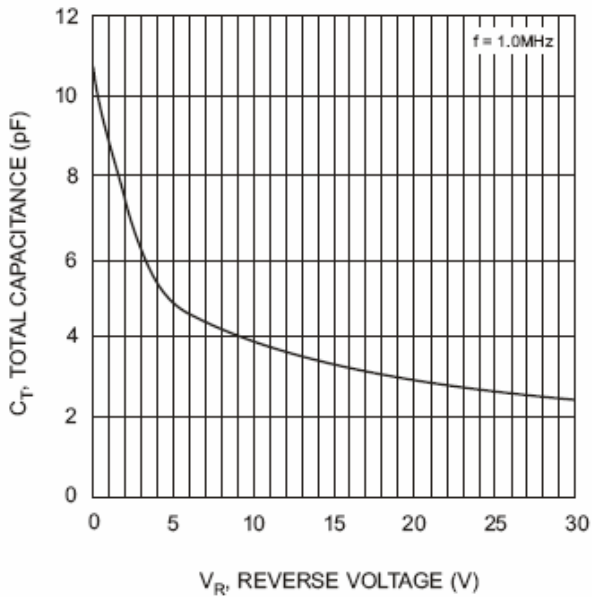

Fig. 3 Typical Capacitance vs. Reverse Voltage

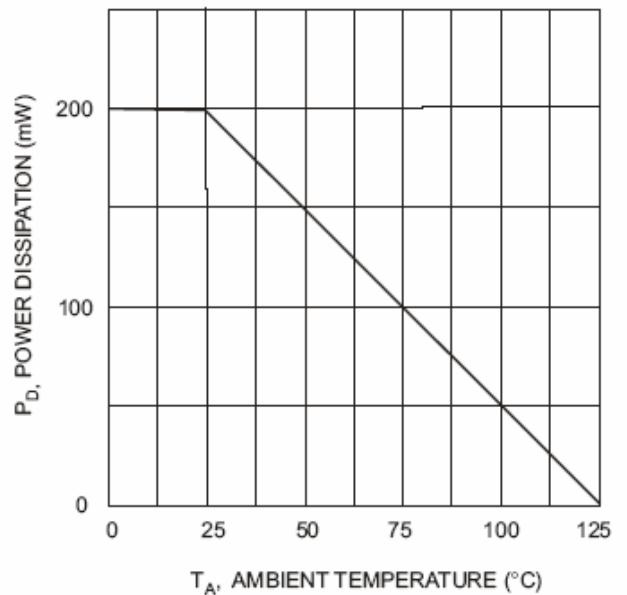

Fig. 4 Power Derating Curve



X-ON Electronics

Largest Supplier of Electrical and Electronic Components

Click to view similar products for [Schottky Diodes & Rectifiers](#) category:

Click to view products by [Microdiode Electronics](#) manufacturer:

Other Similar products are found below :

[CUS06\(Te85L,Q,M\)](#) [MA4E2039](#) [D1FH3-5063](#) [MBR0530L-TP](#) [MBR10100CT-BP](#) [MBR30H100MFST1G](#) [MMBD301M3T5G](#) [PMAD1103-LF](#) [PMAD1108-LF](#) [RB160M-50TR](#) [RB520S-30](#) [RB551V-30](#) [DD350N18K](#) [DZ435N40K](#) [DZ600N16K](#) [BAS16E6433HTMA1](#) [BAS 3010S-02LRH E6327](#) [BAT 54-02LRH E6327](#) [IDL02G65C5XUMA1](#) [NSR05F40QNXT5G](#) [NSVR05F40NXT5G](#) [JANS1N6640](#) [SB07-03C-TB-H](#) [SB1003M3-TL-W](#) [SBAT54CWT1G](#) [SBM30-03-TR-E](#) [SBS818-TL-E](#) [SK32A-LTP](#) [SK33A-TP](#) [SK34A-TP](#) [SK34B-TP](#) [SMD1200PL-TP](#) [ACDBN160-HF](#) [SS3003CH-TL-E](#) [STPS30S45CW](#) [PDS3100Q-7](#) [GA01SHT18](#) [CRS10I30A\(Te85L,QM\)](#) [MBR1240MFST1G](#) [MBRB30H30CT-1G](#) [BAS28E6433HTMA1](#) [BAS 70-02L E6327](#) [HSB123JTR-E](#) [JANTX1N5712-1](#) [VS-STPS40L45CW-N3](#) [DD350N12K](#) [SB007-03C-TB-E](#) [SB10015M-TL-E](#) [SB1003M3-TL-E](#) [SK110-LTP](#)