



1SMA4728A THRU 1SMA4777A

Zener Voltage - 3.3 to 330 Volts Peak Pulse Power - 1.0 W

ZENER DIODES

Features

- ◆ For surface mounted applications in order to optimize board space
- ◆ Low profile package
- ◆ Built-in strain relief
- ◆ Glass passivated junction
- ◆ Low inductance
- ◆ Typical I_R less than $5.0\mu A$ above 11V
- ◆ High temperature soldering guaranteed:
260°C / 10 seconds at terminals
- ◆ Plastic package has Underwriters Laboratory Flammability Classification 94V-0

DO-214AC/SMA

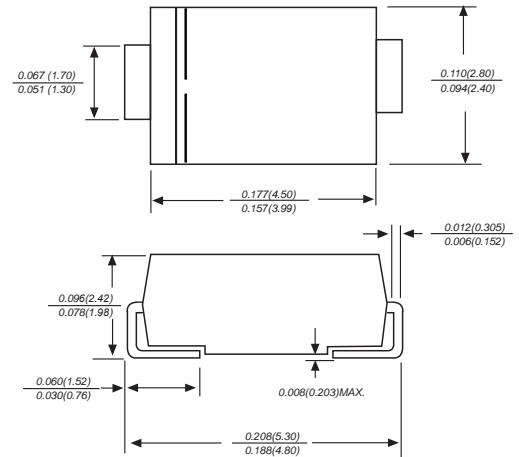

Dimensions in inches and (millimeters)

Mechanical Data

- Case :** JEDEC DO-214AC/SMA Molded plastic body
Terminals : Solder plated, solderable per MIL-STD-750, Method 2026
Polarity : Polarity symbol marking on body
Mounting Position : Any
Weight : 0.0019ounce, 0.055grams
Standard packing : 12mm tape(E1A-481)

Maximum Ratings And Electrical Characteristics

Ratings at 25°C ambient temperature unless otherwise specified.			
MDD Catalog Number	SYMBOLS	VALUE	UNITS
Peak Power Dissipation at $T_A=50^\circ C$, Derate above $50^\circ C$ (Note 1)	P_D	1.0 6.67	Watts mW/°C
Peak Forward Surge Current, 8.3 ms Single Half Sine-wave Superimposed on Rated Load (JEDEC method) (Note 2)	I_{FSM}	10.0	A
Operating and Storage Temperature Range	T_J, T_{STG}	-55 to + 150	°C

- Notes: 1. Mounted on $5.0mm^2$ (0.013mm thick) land areas.
 2. Measured on 8.3ms Single Half Sine-wave or Equivalent Square Wave,
 Duty Cycle=4 Pulses Per Minute Maximum.



1SMA4728A THRU 1SMA4777A

Zener Voltage - 3.3 to 330 Volts Peak Pulse Power - 1.0 W

Ratings And Characteristic Curves

Type	Marking	Zener Voltage Range ⁽¹⁾			I _{ZT} (mA)	Dynamic Impedance	Reverse Current		Admissible Zener Current I _{ZM} (mA)
		V _{ZT} (at I _{ZT})				Z _{ZT} (at I _{ZT})	I _R	at V _R	
		Min (V)	Nom (V)	Max (V)		Max (Ω)	Max (μA)	(V)	
1SMA4728A	728A	3.10	3.3	3.50	75	10	100	1	285
1SMA4729A	729A	3.40	3.6	3.80	69	10	100	1	263
1SMA4730A	730A	3.70	3.9	4.10	64	9.0	50	1	243
1SMA4731A	731A	4.06	4.3	4.56	58	9.0	25	1	219
1SMA4732A	732A	4.50	4.7	4.93	53	8.0	10	1	203
1SMA4733A	733A	4.84	5.1	5.36	49	7.0	10	1	186
1SMA4734A	734A	5.32	5.6	5.92	45	5.0	10	2	170
1SMA4735A	735A	5.86	6.2	6.51	41	2.0	10	3	154
1SMA4736A	736A	6.46	6.8	7.18	37	3.5	10	4	140
1SMA4737A	737A	7.12	7.5	7.88	34	4.0	10	5	127
1SMA4738A	738A	7.79	8.2	8.67	31	4.5	10	6	116
1SMA4739A	739A	8.60	9.1	9.59	28	5.0	10	7	104
1SMA4740A	740A	9.50	10	10.5	25	7.0	10	7	95
1SMA4741A	741A	10.4	11	11.6	23	8.0	5	8	86
1SMA4742A	742A	11.4	12	12.6	21	9.0	5	9	79
1SMA4743A	743A	12.4	13	14.1	19	10	5	10	71
1SMA4744A	744A	13.8	15	15.8	17	14	5	11	63
1SMA4745A	745A	15.2	16	17.1	16	16	5	12	58
1SMA4746A	746A	16.8	18	19.2	14	20	5	13	52
1SMA4747A	747A	19.0	20	21.2	13	22	5	15	47
1SMA4748A	748A	20.8	22	23.3	12	23	5	17	43
1SMA4749A	749A	22.8	24	26.0	11	25	5	18	38
1SMA4750A	750A	25.3	27	28.9	9.5	35	5	21	35
1SMA4751A	751A	28.2	30	32.0	8.5	40	5	23	31
1SMA4752A	752A	31.3	33	34.9	7.5	45	5	25	28
1SMA4753A	753A	34.2	36	37.9	7.0	50	5	27	26
1SMA4754A	754A	37.2	39	41.5	6.5	60	5	30	24
1SMA4755A	755A	40.9	43	45.6	6.0	70	1	32	22
1SMA4756A	756A	44.9	47	49.8	5.5	80	1	35	20
1SMA4757A	757A	48.6	51	54.0	5.0	95	1	38	18
1SMA4758A	758A	53.6	56	58.8	4.5	110	1	42	17
1SMA4759A	759A	58.9	62	65.6	4.0	125	1	47	15
1SMA4760A	760A	64.6	68	71.7	3.7	150	1	52	14
1SMA4761A	761A	71.2	75	78.8	3.3	175	1	56	12
1SMA4762A	762A	77.9	82	87.0	3.0	200	1	62	11
1SMA4763A	763A	86.0	91	96.0	2.8	250	1	69	10
1SMA4764A	764A	95.0	100	105	2.5	350	1	76	9.5
1SMA4765A	765A	104	110	116	2.3	450	1	84	8.6
1SMA4766A	766A	114	120	127	2.0	550	1	91	7.8
1SMA4767A	767A	125	135	142	1.9	700	1	100	7.0
1SMA4768A	768A	140	150	157	1.7	900	1	110	6.3
1SMA4769A	769A	155	165	172	1.6	1100	1	120	5.8
1SMA4770A	770A	170	180	191	1.4	1200	1	135	5.2
1SMA4771A	771A	189	200	211	1.2	1400	1	150	4.7
1SMA4772A	772A	209	220	231	1.0	1600	1	165	4.3
1SMA4773A	773A	229	240	251	1.0	1800	1	180	3.9
1SMA4774A	774A	249	260	271	1.0	2000	1	190	3.7
1SMA4775A	775A	269	280	291	1.0	2100	1	205	3.4
1SMA4776A	776A	289	300	315	1.0	2300	1	230	3.1
1SMA4777A	777A	313	330	346	1.0	2500	1	250	2.8

(1) V_{ZT} is tested with pulses (20 ms)



1SMA4728A THRU 1SMA4777A

Zener Voltage - 3.3 to 330 Volts Peak Pulse Power - 1.0 W

FIG.1- POWER TEMPERATURE DERATING CURVE

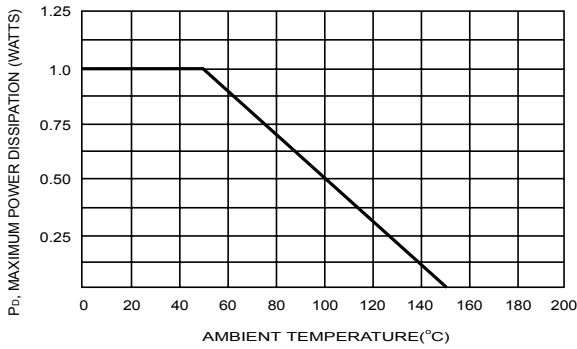

FIG.2- TYPICAL FORWARD CHARACTERISTICS

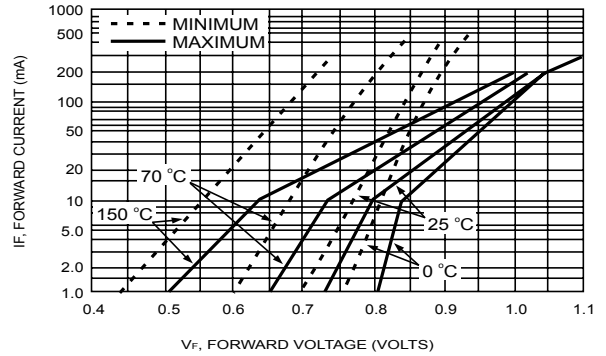

FIG.3- EFFECT OF ZENER CURRENT ON ZENER IMPEDANCE

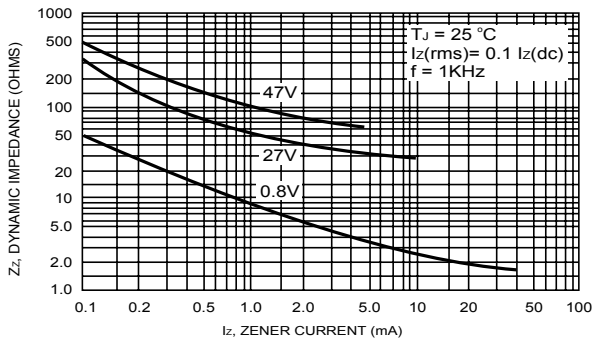

FIG.5- TYPICAL LEAKAGE CURRENT

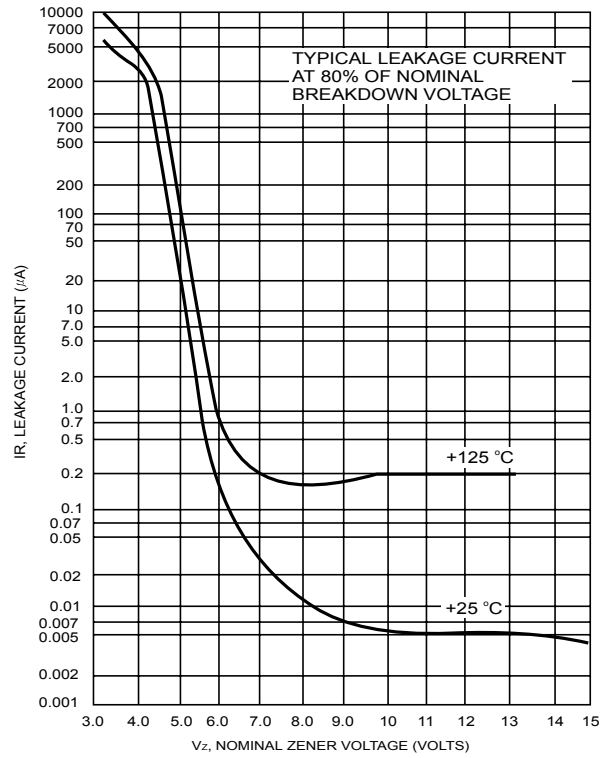

FIG.4- EFFECT OF ZENER VOLTAGE ON ZENER IMPEDANCE

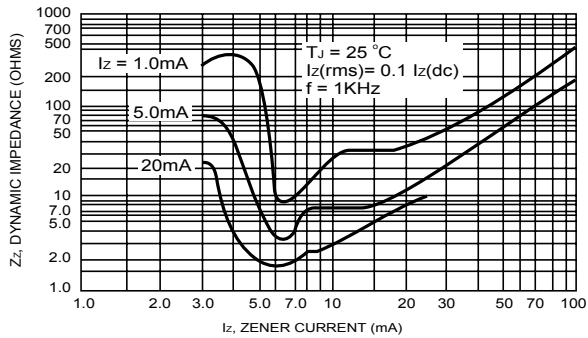

FIG.6- TYPICAL CAPACITANCE versus V_Z

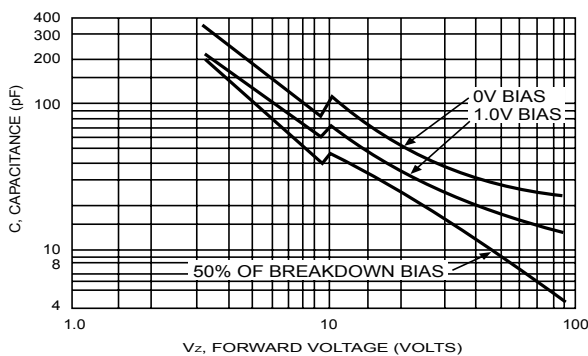
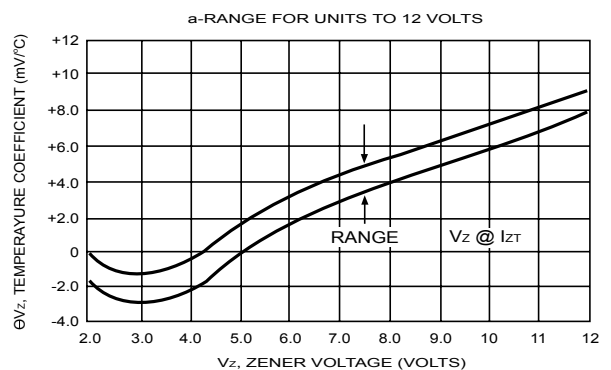

FIG.7- TEMPERATURE COEFFICIENTS



The cruve graph is for reference only



1SMA4728A THRU 1SMA4777A

Zener Voltage - 3.3 to 330 Volts Peak Pulse Power - 1.0 W

FIG.7- TEMPERATURE COEFFICIENTS

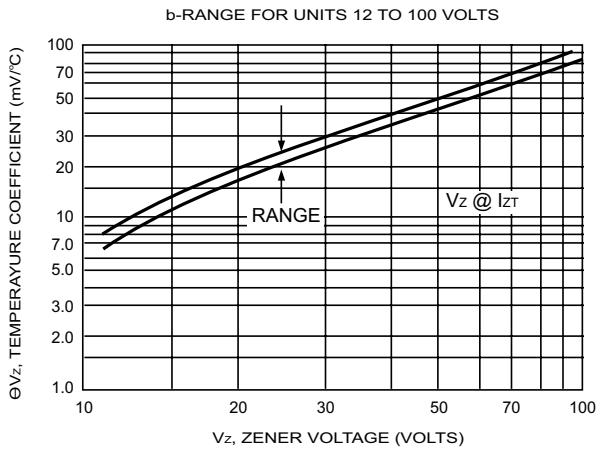

FIG.8- EFFECT OF ZENER CURRENT

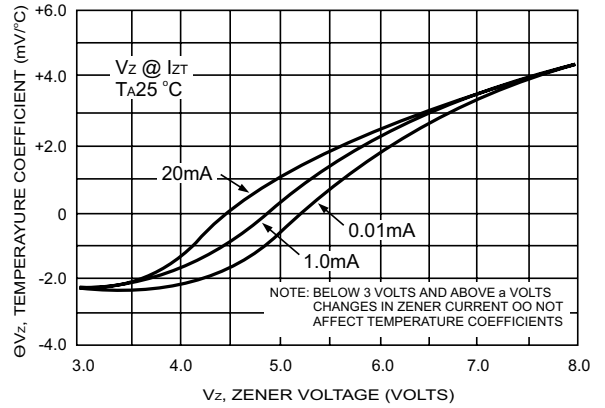
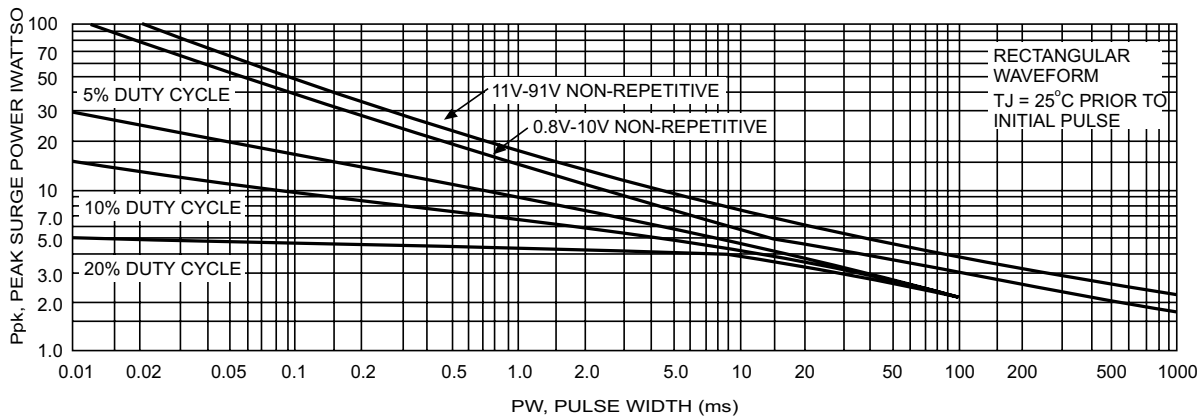

FIG.9- MAXIMUM SURGE POWER



The cruve graph is for reference only



1SMA4728A THRU 1SMA4777A

Zener Voltage - 3.3 to 330 Volts Peak Pulse Power - 1.0 W

Packing information

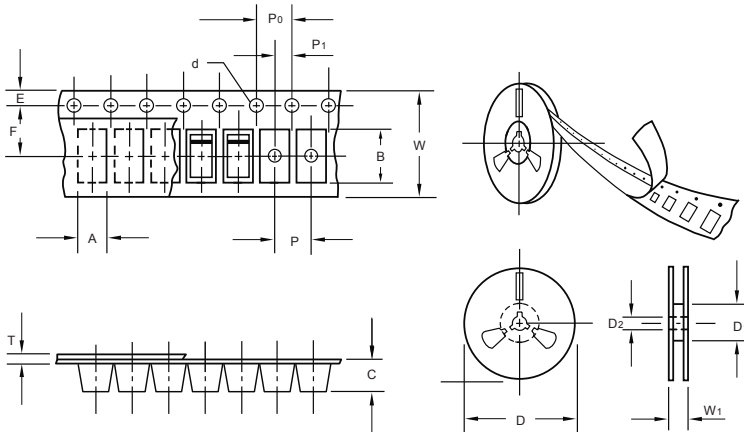

unit:mm

Item	Symbol	Tolerance	SMA
Carrier width	A	0.1	2.80
Carrier length	B	0.1	5.33
Carrier depth	C	0.1	2.36
Sprocket hole	d	0.05	1.50
13" Reel outside diameter	D	2.0	330.00
13" Reel inner diameter	D ₁	min	50.00
7" Reel outside diameter	D	2.0	178.00
7" Reel inner diameter	D ₁	min	62.00
Feed hole diameter	D ₂	0.5	13.00
Sprocket hole position	E	0.1	1.75
Punch hole position	F	0.1	5.50
Punch hole pitch	P	0.1	4.00
Sprocket hole pitch	P ₀	0.1	4.00
Embossment center	P ₁	0.1	2.00
Overall tape thickness	T	0.1	0.28
Tape width	W	0.3	12.00
Reel width	W ₁	1.0	18.00

Note: Devices are packed in accordance with EIA standard RS-481-A and specifications listed above.

Reel packing

PACKAGE	REEL SIZE	REEL (pcs)	COMPONENT SPACING (m/m)	BOX (pcs)	INNER BOX (m/m)	REEL DIA. (m/m)	CARTON SIZE (m/m)	CARTON (pcs)	APPROX. GROSS WEIGHT (kg)
SMA	7"	2,000	4.0	4,000	183*155*183	178	382*356*392	80,000	12.0
SMA	11"	5,000	4.0	10,000	290*290*38	330	310*310*360	80,000	11.0
SMA	13"	7,500	4.0	15,000	335*335*38	330	350*330*360	120,000	14.5

Suggested Pad Layout

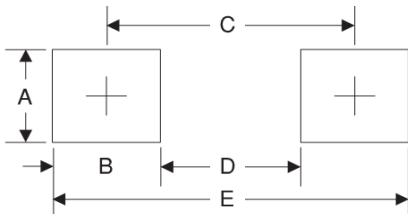

Symbol	Unit (mm)	Unit (inch)
A	1.68	0.066
B	1.52	0.060
C	3.90	0.154
D	2.41	0.095
E	5.45	0.215

X-ON Electronics

Largest Supplier of Electrical and Electronic Components

Click to view similar products for [Zener Diodes](#) category:

Click to view products by [Microdiode Electronics](#) manufacturer:

Other Similar products are found below :

[RKZ13B2KG#P1](#) [DL5234B](#) [1N4682](#) [1N4693](#) [1N4732A](#) [1N4736A](#) [1N4750A](#) [1N4759ARL](#) [1N5241B](#) [1N5365B](#) [1N5369B](#) [1N747A](#)
[1N964B](#) [1N966B](#) [1N968B](#) [1N972B](#) [JANS1N4974US](#) [1N4692](#) [1N4702](#) [1N4704](#) [1N4711](#) [1N4714](#) [1N4745ARL](#) [1N4752ARL](#) [1N4760ARL](#)
[1N5221B](#) [1N5242BTR](#) [1N5350B](#) [1N5352B](#) [1N961BRR1](#) [1N964BRL](#) [RKZ5.1BKU#P6](#) [3SMAJ5946B-TP](#) [3SMAJ5950B-TP](#)
[MMSZ5230BQ-13-F](#) [MMSZ5232BQ-13-F](#) [BZX84C7V5](#) [3SMAJ5945B-TP](#) [3SMAJ5947B-TP](#) [3SMBJ5941B-TP](#) [DZ2S240M0L](#) [SMAZ27-](#)
[TP](#) [ZMM5224B-7](#) [RD16UM-T1-A](#) [RD39S-T1-A](#) [RD10S-T1-A](#) [CDZT2R5.6B](#) [1N4762A G](#) [Z1SMA18](#) [JANTX1N4553B](#)