

SOT-23 Plastic-Encapsulate Transistors

2SC1623 TRANSISTOR (NPN)

FEATURES

- High DC current gain : $h_{FE}=200(\text{Typ})$ $V_{CE}=6V, I_C=1mA$
- High voltage: $V_{CEO}=50V$

MAXIMUM RATINGS ($T_a=25^\circ\text{C}$ unless otherwise noted)

| Symbol | Parameter | Value | Unit |
|-----------------|---|----------|---------------------------|
| V_{CBO} | Collector-Base Voltage | 60 | V |
| V_{CEO} | Collector-Emitter Voltage | 50 | V |
| V_{EBO} | Emitter-Base Voltage | 5 | V |
| I_C | Collector Current | 100 | mA |
| P_C | Collector Power Dissipation | 200 | mW |
| $R_{\theta JA}$ | Thermal Resistance From Junction To Ambient | 625 | $^\circ\text{C}/\text{W}$ |
| T_j | Junction Temperature | 150 | $^\circ\text{C}$ |
| T_{stg} | Storage Temperature | -55~+150 | $^\circ\text{C}$ |

SOT-23

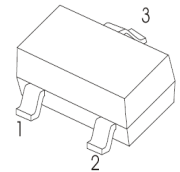

1. BASE
2. EMITTER
3. COLLECTOR

ELECTRICAL CHARACTERISTICS ($T_a=25^\circ\text{C}$ unless otherwise specified)

| Parameter | Symbol | Test conditions | Min | Typ | Max | Unit |
|--------------------------------------|---------------|-------------------------------------|-----|-----|-----|---------------|
| Collector-base breakdown voltage | $V_{(BR)CBO}$ | $I_C=100\mu\text{A}, I_E=0$ | 60 | | | V |
| Collector-emitter breakdown voltage | $V_{(BR)CEO}$ | $I_C=1\text{mA}, I_B=0$ | 50 | | | V |
| Emitter-base breakdown voltage | $V_{(BR)EBO}$ | $I_E=100\mu\text{A}, I_C=0$ | 5 | | | V |
| Collector cut-off current | I_{CBO} | $V_{CB}=60V, I_E=0$ | | | 0.1 | μA |
| Emitter cut-off current | I_{EBO} | $V_{EB}=5V, I_C=0$ | | | 0.1 | μA |
| DC current gain | h_{FE} | $V_{CE}=6V, I_C=1\text{mA}$ | 90 | 200 | 600 | |
| Collector-emitter saturation voltage | $V_{CE(sat)}$ | $I_C=100\text{mA}, I_B=10\text{mA}$ | | | 0.3 | V |
| Base-emitter saturation voltage | $V_{BE(sat)}$ | $I_C=100\text{mA}, I_B=10\text{mA}$ | | | 1 | V |
| Transition frequency | f_T | $V_{CE}=6V, I_C=10\text{mA}$ | | 250 | | MHz |

CLASSIFICATION OF h_{FE}

| Rank | L4 | L5 | L6 | L7 |
|---------|--------|---------|---------|---------|
| Range | 90-180 | 135-270 | 200-400 | 300-600 |
| Marking | L4 | L5 | L6 | L7 |

Typical Characteristics

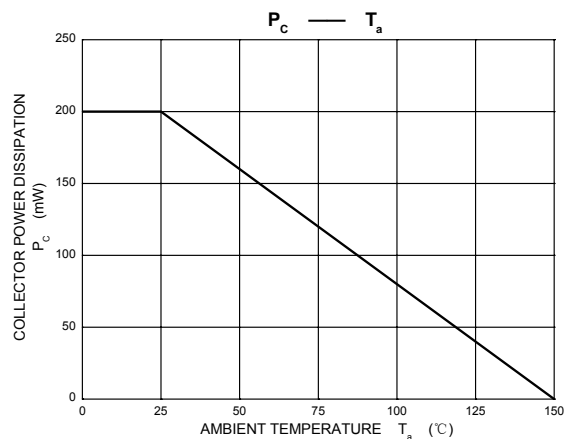
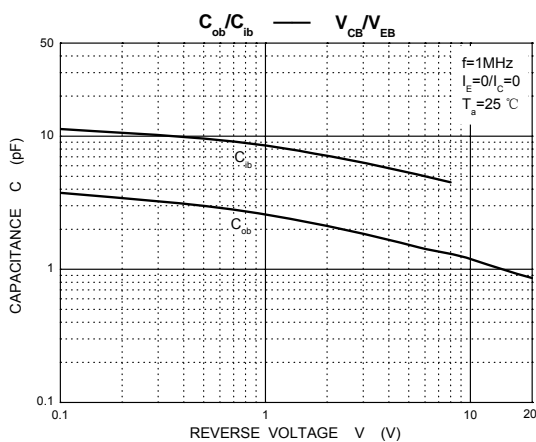
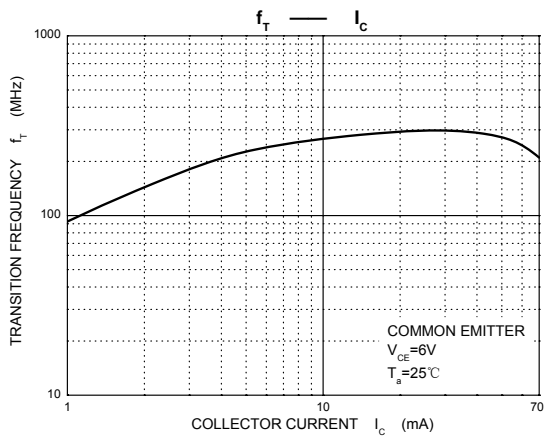
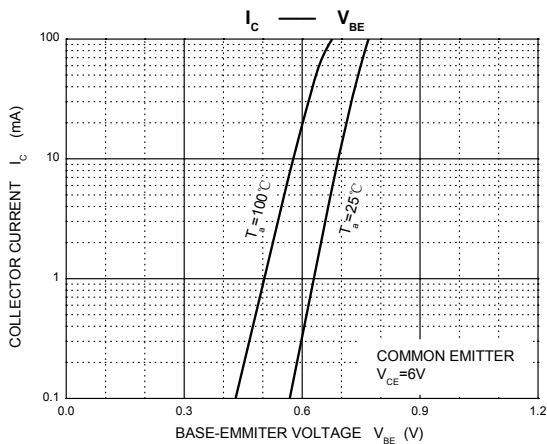
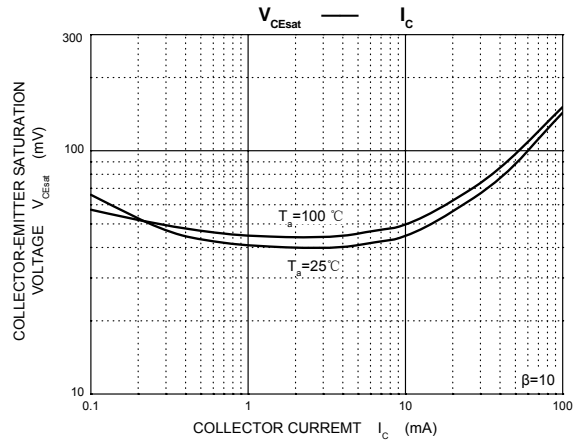
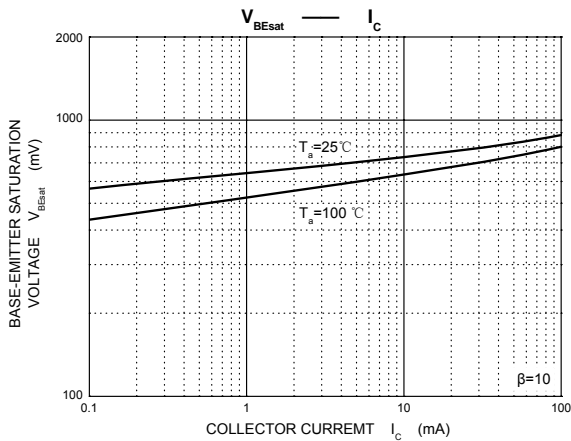
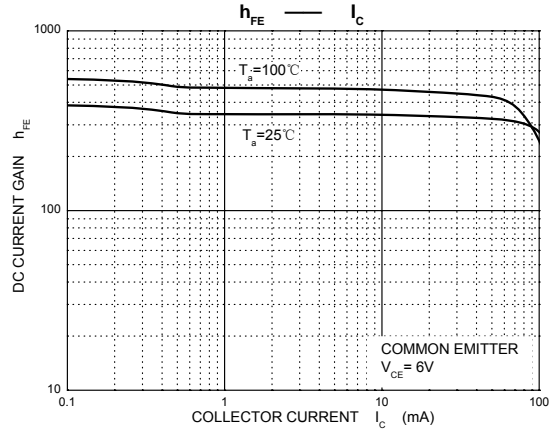
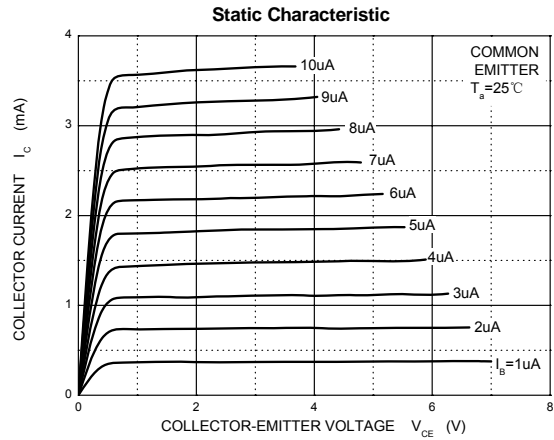

Outlitne Drawing

SOT-23 Package Outline Dimensions

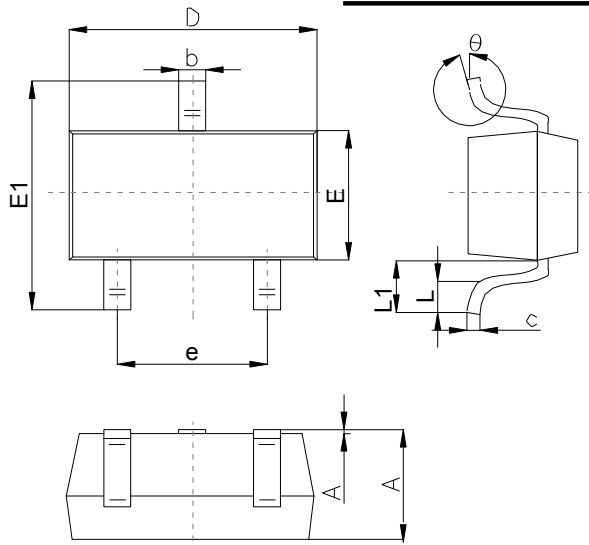

| Symbol | Dimensions In Millimeters | | |
|--------|---------------------------|------|------|
| | Min | Typ | Max |
| A | 1.00 | | 1.40 |
| A1 | | | 0.10 |
| b | 0.35 | | 0.50 |
| c | 0.10 | | 0.20 |
| D | 2.70 | 2.90 | 3.10 |
| E | 1.40 | | 1.60 |
| E1 | 2.4 | | 2.80 |
| e | | 1.90 | |
| L | 0.10 | | 0.30 |
| L1 | 0.4 | | |
| θ | 0° | | 10° |

Suggested Pad Layout

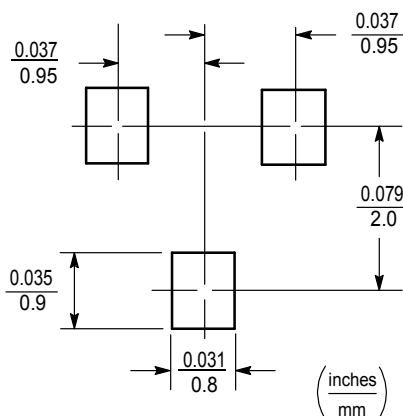

- Note:
1. Controlling dimension:in/millimeters.
 2. General tolerance: ±0.05mm.
 3. The pad layout is for reference purposes only.

Important Notice and Disclaimer

Microdiode Electronics (Jiangsu) reserves the right to make changes to this document and its products and specifications at any time without notice. Customers should obtain and confirm the latest product information and specifications before final design,purchase or use.

Microdiode Electronics (Jiangsu) makes no warranty, representation or guarantee regarding the suitability of its products for any particular purpose, not does Microdiode Electronics (Jiangsu) assume any liability for application assistance or customer product design. Microdiode Electronics (Jiangsu) does not warrant or accept any liability with products which are purchased or used for any unintended or unauthorized application.

No license is granted by implication or otherwise under any intellectual property rights of Microdiode Electronics (Jiangsu).

Microdiode Electronics (Jiangsu) products are not authorized for use as critical components in life support devices or systems without express written approval of Microdiode Electronics (Jiangsu).

SOT-23 Tape and Reel

SOT-23 Embossed Carrier Tape

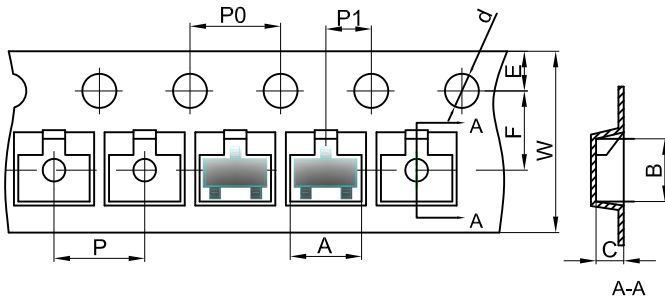

Packaging Description:

SOT-23 parts are shipped in tape. The carrier tape is made from a dissipative (carbon filled) polycarbonate resin. The cover tape is a multilayer film (Heat Activated Adhesive in nature) primarily composed of polyester film, adhesive layer, sealant, and anti-static sprayed agent. These reeled parts in standard option are shipped with 3,000 units per 7" or 17.8cm diameter reel. The reels are clear in color and is made of polystyrene plastic (anti-static coated).

| Dimensions are in millimeter | | | | | | | | | | |
|------------------------------|------|------|------|-------|------|------|------|------|------|------|
| Pkg type | A | B | C | d | E | F | P0 | P | P1 | W |
| SOT-23 | 3.15 | 2.77 | 1.22 | Ø1.50 | 1.75 | 3.50 | 4.00 | 4.00 | 2.00 | 8.00 |

SOT-23 Tape Leader and Trailer

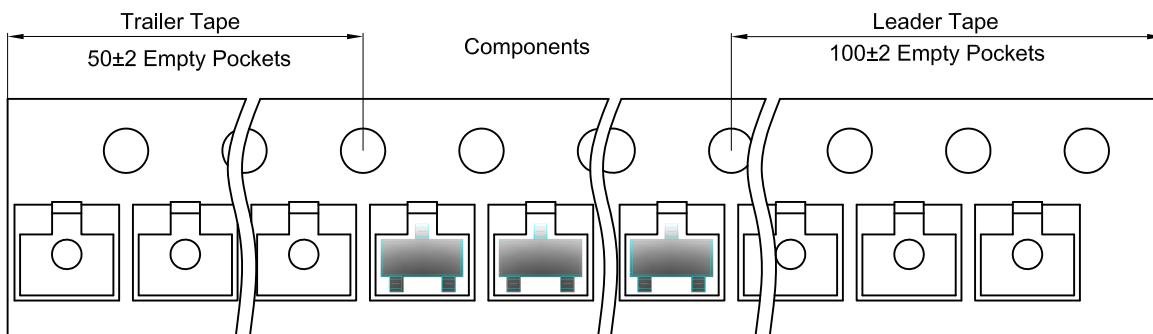

SOT-23 Reel

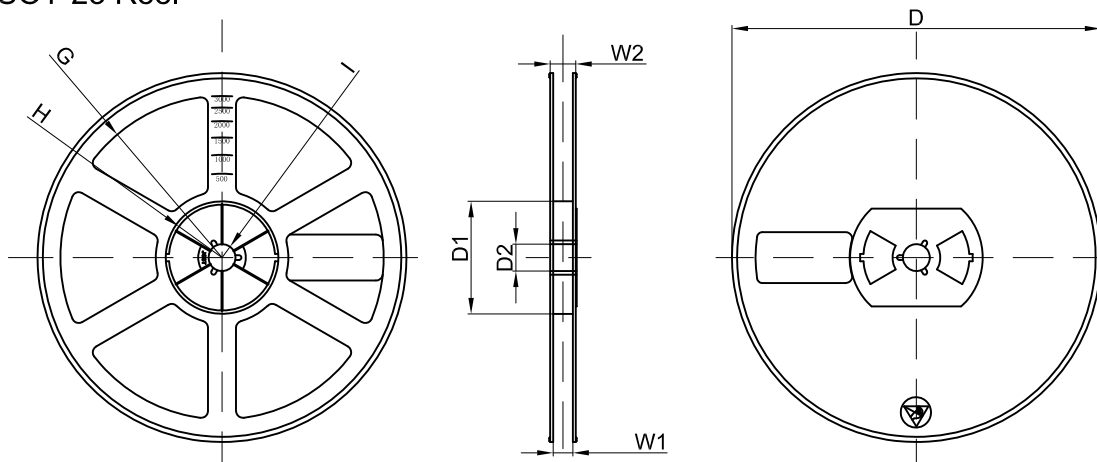

| Dimensions are in millimeter | | | | | | | | |
|------------------------------|---------|-------|-------|--------|--------|-------|------|-------|
| Reel Option | D | D1 | D2 | G | H | I | W1 | W2 |
| 7" Dia | Ø178.00 | 54.40 | 13.00 | R78.00 | R25.60 | R6.50 | 9.50 | 12.30 |

| REEL | Reel Size | Box | Box Size(mm) | Carton | Carton Size(mm) | G.W.(kg) |
|----------|-----------|------------|--------------|-------------|-----------------|----------|
| 3000 pcs | 7 Inch | 45,000 pcs | 203×203×195 | 180,000 pcs | 438×438×220 | |

X-ON Electronics

Largest Supplier of Electrical and Electronic Components

Click to view similar products for [Bipolar Transistors - BJT category](#):

Click to view products by [Microdiode Electronics manufacturer](#):

Other Similar products are found below :

[619691C](#) [MCH4017-TL-H](#) [MMBT-2369-TR](#) [BC546/116](#) [BC557/116](#) [BSW67A](#) [NJVMJD148T4G](#) [NTE123AP-10](#) [NTE153MCP](#) [NTE16](#)
[NTE195A](#) [NTE92](#) [2N4401-A](#) [2N6728](#) [2SA1419T-TD-H](#) [2SA2126-E](#) [2SB1204S-TL-E](#) [2SC2712S-GR,LF](#) [SP000011176](#) [2N2907A](#) [2N3904-](#)
[NS](#) [2N5769](#) [2SC2412KT146S](#) [CPH6501-TL-E](#) [MCH4021-TL-E](#) [MJE340](#) [Jantx2N5416](#) [US6T6TR](#) [NJL0281DG](#) [732314D](#) [CPH3121-TL-E](#)
[CPH6021-TL-H](#) [873787E](#) [IMZ2AT108](#) [MMST8098T146](#) [UMX21NTR](#) [MCH6102-TL-E](#) [NJL0302DG](#) [30A02MH-TL-E](#) [NTE13](#) [NTE26](#)
[NTE282](#) [NTE323](#) [NTE350](#) [NTE81](#) [STX83003-AP](#) [JANTX2N2920L](#) [JANSR2N2222AUB](#) [CMLT3946EG TR](#) [2SA1371D-AE](#)