



BZT52B-Series

Small Signal Zener Diodes

SOD-323 Plastic-Encapsulate Diodes

6 NH) & 6 J \$ S! 6 NH) & 6 +) S N9B9F DIODE

SOD-323



FEATURES

- V[caÁ [, ^iÁã • q aã } kT æB€€ Y
- Y ã^Á^} ^iÁ^ç^! • ^Áç [ca^Áã * ^ÁGEXÁ Á Í XÈ
- Ù{ æÁ [æ caÁ æ & æ ^Á ~ ãca | Á | Á ~ | æ & Á { [~ } ç á Á ^ • ã } È
- V[| ^i æ & ^ Á ç] | [çã æ | t GÃ

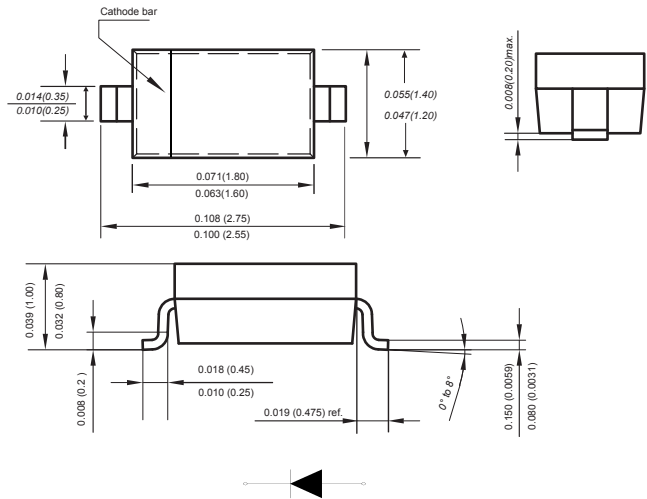

Dimensions in inches and (millimeters)

Mechanical Data

Case : SOD-323

Terminals : Solderable per MIL-STD-750, Method 2026

Polarity : Polarity symbol marking on body

Mounting Position : Any

Weight : 0.00019 ounce, 0.00548 grams

Maximum Ratings (Ta=25°C unless otherwise specified)

Characteristic	Symbol	Value	Unit
Forward Voltage at If = 10mA (Note 2)	V _F	0.9	V
Power Dissipation (Note 1)	P _d	3€0	mW
Typical thermal resistance from junction to ambient (Note 1)	R _{θJA}	117	°C/W
Junction Temperature	T _j	150	°C
Storage Temperature Range	T _{stg}	-55 ~ +150	°C

Notes: 1. Thermal resistance from junction to ambient at P.C.B. mounted with 2.0" X 2.0" (5 X 5 cm) copper areas pads.

2. Short duration test pulse used to minimize self-heating effect

3. f = 1kHz



BZT52B-Series

Small Signal Zener Diodes

ELECTRICAL CHARACTERISTICS @ Ta=25°C unless otherwise specified

Type	Marking	Zener Voltage Range ⁽¹⁾			I _{ZT} (mA)	Dynamic Impedance Z _{ZT} (at I _{ZT}) Max (Ω)	Reverse Current	
		V _{ZT} (at I _{ZT})					I _R	at V _R
		Min (V)	Nom (V)	Max (V)			Max (μA)	(V)
BZT52B2V0S	20B	1.96	2	2.04	5	100	120	0.5
BZT52B2V2S	20C	2.16	2.2	2.24	5	100	120	0.7
BZT52B2V4S	2C1	2.35	2.4	2.45	5	100	120	1
BZT52B2V7S	2D1	2.65	2.7	2.75	5	110	120	1
BZT52B3V0S	2E1	2.94	3	3.06	5	120	50	1
BZT52B3V3S	2F1	3.23	3.3	3.37	5	130	20	1
BZT52B3V6S	2H1	3.53	3.6	3.67	5	130	10	1
BZT52B3V9S	2J1	3.82	3.9	3.98	5	130	5	1
BZT52B4V3S	2K1	4.21	4.3	4.39	5	130	5	1
BZT52B4V7S	2M1	4.61	4.7	4.79	5	130	2	1
BZT52B5V1S	2N1	5	5.1	5.20	5	130	2	1.5
BZT52B5V6S	2P1	5.49	5.6	5.71	5	80	1	2.5
BZT52B6V2S	2R1	6.08	6.2	6.32	5	50	1	3
BZT52B6V8S	2X1	6.66	6.8	6.94	5	30	0.5	3.5
BZT52B7V5S	2Y1	7.35	7.5	7.65	5	30	0.5	4
BZT52B8V2S	2Z1	8.04	8.2	8.36	5	30	0.5	5
BZT52B9V1S	2A2	8.92	9.1	9.28	5	30	0.5	6
BZT52B10S	2B2	9.8	10	10.2	5	30	0.1	7
BZT52B11S	2C2	10.78	11	11.22	5	30	0.1	8
BZT52B12S	2D2	11.76	12	12.24	5	35	0.1	9
BZT52B13S	2E2	12.74	13	13.26	5	35	0.1	10
BZT52B15S	2F2	14.7	15	15.3	5	40	0.1	11
BZT52B16S	2H2	15.68	16	16.32	5	40	0.1	12
BZT52B18S	2J2	17.64	18	18.36	5	45	0.1	13
BZT52B20S	2K2	19.6	20	20.4	5	50	0.1	15
BZT52B22S	2M2	21.56	22	22.44	5	55	0.1	17
BZT52B24S	2N2	23.52	24	24.48	5	60	0.1	19
BZT52B27S	2P2	26.46	27	27.54	2	70	0.1	21
BZT52B30S	2R2	29.4	30	30.6	2	80	0.1	23
BZT52B33S	2X2	32.34	33	33.66	2	80	0.1	25
BZT52B36S	2Y2	35.28	36	36.72	2	90	0.1	27
BZT52B39S	2Z2	38.22	39	39.78	2	100	0.1	30
BZT52B43S	2A3	42.14	43	43.86	2	130	0.1	33
BZT52B47S	2B3	46.06	47	47.94	2	150	0.1	36
BZT52B51S	2C3	49.98	51	52.02	2	180	0.1	39
BZT52B56S	2D3	54.88	56	57.12	2	200	0.1	43
BZT52B62S	2E3	60.76	62	63.24	2	215	0.1	47
BZT52B68S	2F3	66.64	68	69.36	2	240	0.1	52
BZT52B75S	2H3	73.5	75	76.5	2	265	0.1	56

(1) V_{ZT} is tested with pulses (20 ms)

Typical Characteristics

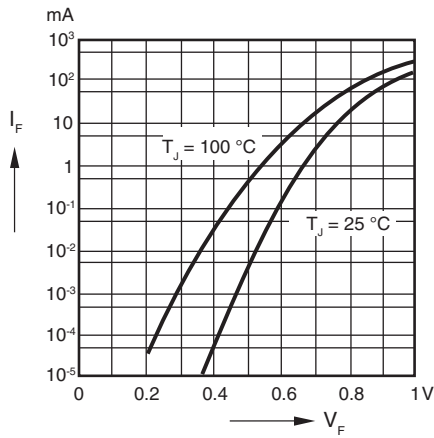

Fig. 1 - Forward characteristics

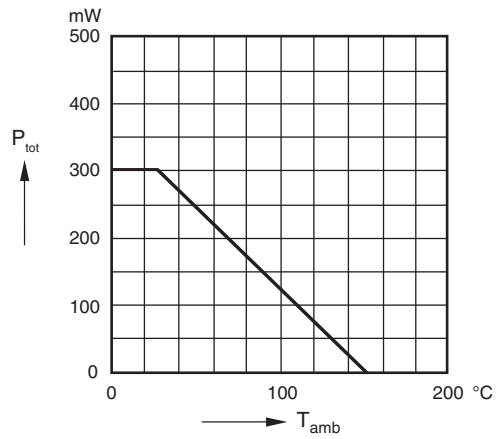

Fig. 2 - Admissible Power Dissipation vs. Ambient Temperature

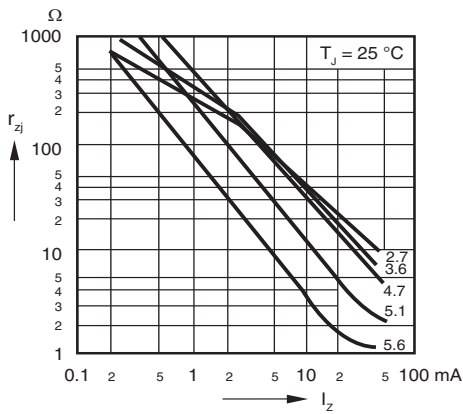

Fig. 3 - Dynamic Resistance vs. Zener Current

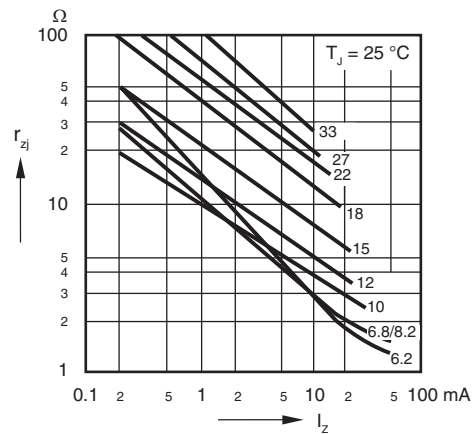

Fig. 4 - Dynamic Resistance vs. Zener Current

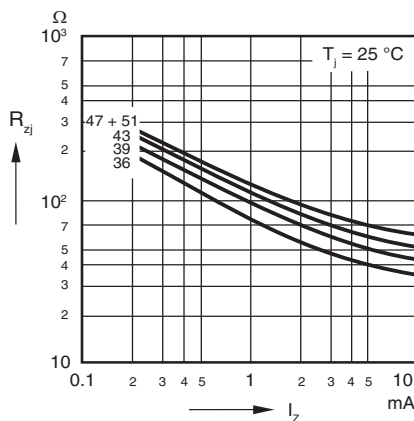

Fig. 5 - Dynamic Resistance vs. Zener Current

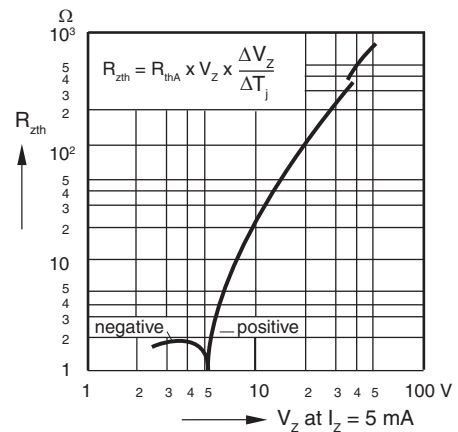

Fig. 6 - Thermal Differential Resistance vs. Zener Voltage

Typical Characteristics

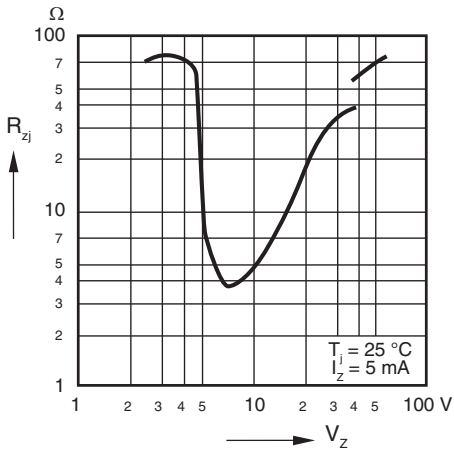

Fig. 7 - Dynamic Resistance vs. Zener Voltage

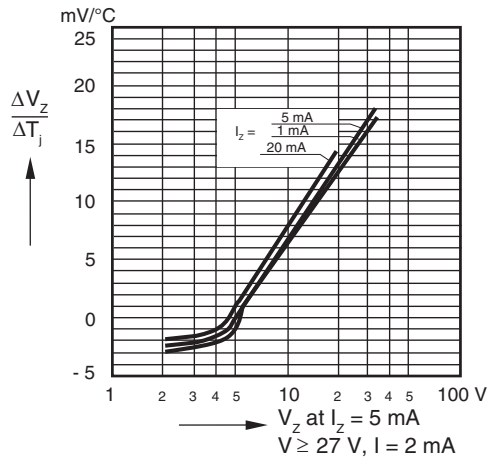

Fig. 8 - Temperature Dependence of Zener Voltage vs. Zener Voltage

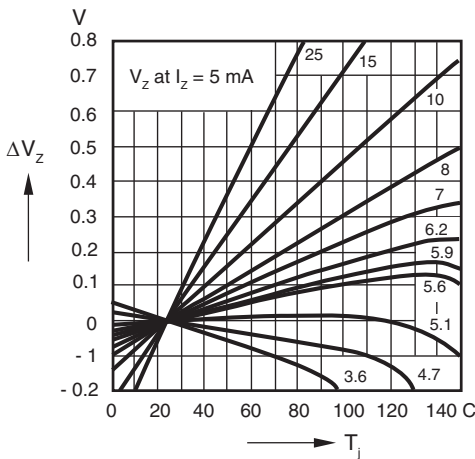

Fig. 9 - Change of Zener Voltage vs. Junction Temperature

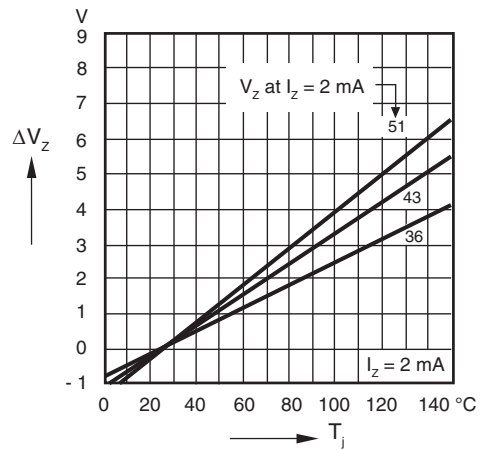

Fig. 10 - Change of Zener Voltage vs. Junction Temperature

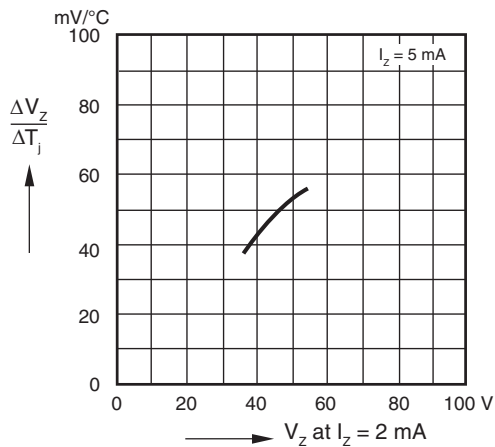

Fig. 11 - Temperature Dependence of Zener Voltage vs. Zener Voltage

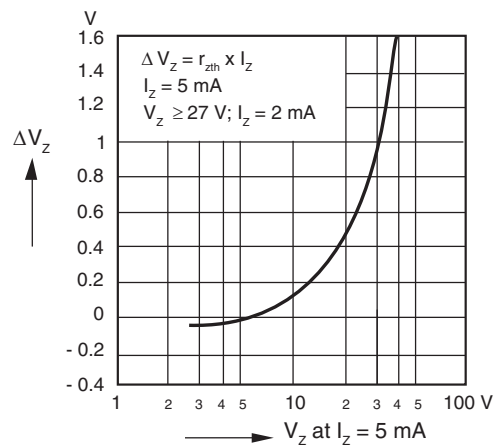

Fig. 12 - Change of Zener Voltage from Turn-on up to the Point of Thermal Equilibrium vs. Zener Voltage



BZT52B-Series

Small Signal Zener Diodes

Typical Characteristics

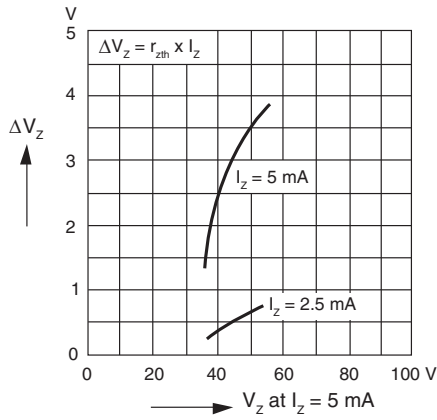

Fig. 13 - Change of Zener Voltage from Turn-on up to the Point of Thermal Equilibrium vs. Zener Voltage

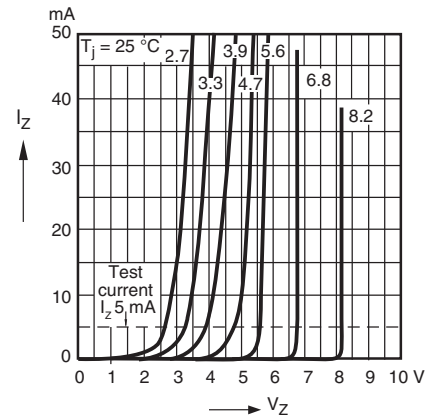

Fig. 14 - Breakdown Characteristics

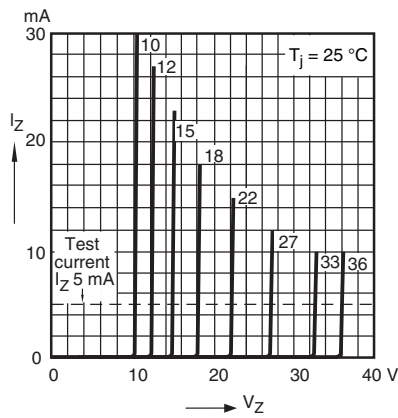

Fig. 15 - Breakdown Characteristics

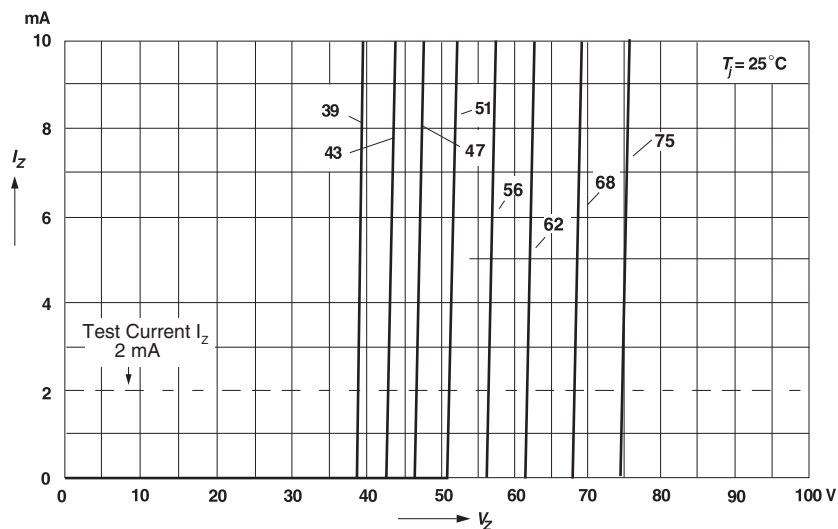

Fig. 16 - Breakdown Characteristics

The curve above is for reference only.



BZT52B-Series

Small Singnal Zener Diodes

Packing information

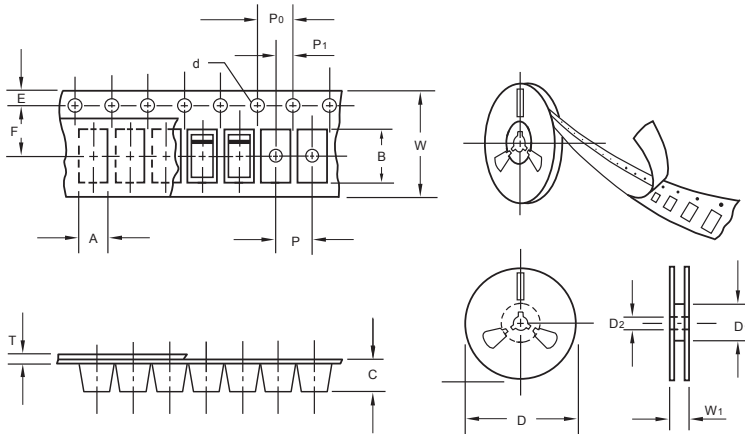

unit:mm

Item	Symbol	Tolerance	SOD-323
Carrier width	A	0.1	2.1
Carrier length	B	0.1	4.0
Carrier depth	C	0.1	1.60
Sprocket hole	d	0.05	1.55
7" Reel outside diameter	D	2.0	178.00
7" Reel inner diameter	D ₁	min	50.0
Feed hole diameter	D ₂	0.5	13.00
Sprocket hole position	E	0.1	1.75
Punch hole position	F	0.1	3.50
Punch hole pitch	P	0.1	4.00
Sprocket hole pitch	P ₀	0.1	4.00
Embossment center	P ₁	0.1	2.00
Overall tape thickness	T	0.1	0.25
Tape width	W	0.3	8.15
Reel width	W ₁	1.0	10.5

Note: Devices are packed in accordance with EIA standard RS-481-A and specifications listed above.

Reel packing

PACKAGE	REEL SIZE	REEL (pcs)	COMPONENT SPACING (m/m)	BOX (pcs)	INNER BOX (m/m)	REEL DIA. (m/m)	CARTON SIZE (m/m)	CARTON (pcs)	APPROX. GROSS WEIGHT (kg)
SOD-323	7"	3,000	4.0	45,000	210*208*203	178	430*430*235	180,000	

Suggested Pad Layout

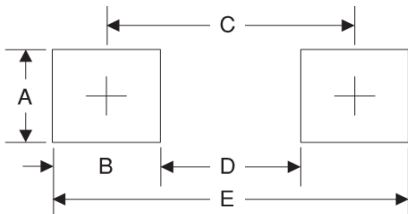

Symbol	Unit (mm)	Unit (inch)
A	0.7	0.028
B	0.7	0.028
C	2.15	0.085
D	1.8	0.071
E	2.85	0.112

X-ON Electronics

Largest Supplier of Electrical and Electronic Components

Click to view similar products for [Zener Diodes](#) category:

Click to view products by [Microdiode Electronics](#) manufacturer:

Other Similar products are found below :

[RKZ13B2KG#P1](#) [DL5234B](#) [1N4682](#) [1N4693](#) [1N4732A](#) [1N4736A](#) [1N4750A](#) [1N4759ARL](#) [1N5241B](#) [1N5365B](#) [1N5369B](#) [1N747A](#)
[1N964B](#) [1N966B](#) [1N968B](#) [1N972B](#) [JANS1N4974US](#) [1N4692](#) [1N4702](#) [1N4704](#) [1N4711](#) [1N4714](#) [1N4745ARL](#) [1N4752ARL](#) [1N4760ARL](#)
[1N5221B](#) [1N5242BTR](#) [1N5350B](#) [1N5352B](#) [1N961BRR1](#) [1N964BRL](#) [RKZ5.1BKU#P6](#) [3SMAJ5946B-TP](#) [3SMAJ5950B-TP](#)
[MMSZ5230BQ-13-F](#) [MMSZ5232BQ-13-F](#) [BZX84C7V5](#) [3SMAJ5945B-TP](#) [3SMAJ5947B-TP](#) [3SMBJ5941B-TP](#) [DZ2S240M0L](#) [SMAZ27-](#)
[TP](#) [ZMM5224B-7](#) [RD16UM-T1-A](#) [RD39S-T1-A](#) [RD10S-T1-A](#) [CDZT2R5.6B](#) [1N4762A G](#) [Z1SMA18](#) [JANTX1N4553B](#)