



BZT52C-Series

Small Signal Zener Diodes

SOD-323 Plastic-Encapsulate Diodes

6 NH) &C&J \$S!6 NH) &C+) S N9B9F DIODE

SOD-323



FEATURES

- Planar die construction.
- V [ca] [, ^! Áã • ä æ] K T æ Æ € { Y Y ã ^ Á
- : ^ } ^! Á ^ ç ^! • ^ Á [| ca ^ Á æ * ^ Á G E X Á Á Í X È
- General purpose, medium current .
- Ù { æ | Á | æ ca Á æ & æ ^ Á ~ ä æ ^ Á | Á ~ | - æ ^ Á { [~ } ç á Á ^ • ä } È
- V [| ^! æ & ^ Á æ] | | ç ä æ ^! t 5 Ä

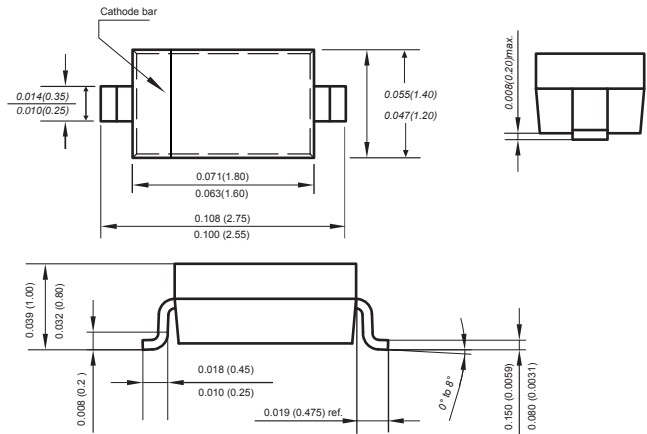

Marking



XX= Device code, see table on page 2 the marking code
The marking bar indicates the cathode

Mechanical Data

- Case** : SOD-323
Terminals : Solderable per MIL-STD-750, Method 2026
Polarity : Polarity symbol marking on body
Mounting Position : Any
Weight : 0.00019 ounce, 0.00548 grams

Maximum Ratings (Ta=25°C unless otherwise specified)

Characteristic	Symbol	Value	Unit
Forward Voltage at I _F = 10mA (Note 2)	V _F	0.9	V
Power Dissipation (Note 1)	P _d	2€0	mW
Typical thermal resistance from junction to ambient (Note 1)	R _{θJA}	117	°C/W
Junction Temperature	T _j	150	°C
Storage Temperature Range	T _{stg}	-55 ~ +150	°C

- Notes: 1. Thermal resistance from junction to ambient at P.C.B. mounted with 2.0" X 2.0" (5 X 5 cm) copper areas pads.
 2. Short duration test pulse used to minimize self-heating effect
 3. f = 1 kHz



BZT52C-Series

Small Signal Zener Diodes

ELECTRICAL CHARACTERISTICS @ Ta=25°C unless otherwise specified

Type	Marking	Zener Voltage Range ⁽¹⁾			I _{ZT} (mA)	Dynamic Impedance Z _{ZT} (at I _{ZT}) Max (Ω)	Reverse Current	
		V _{ZT} (at I _{ZT})					I _R Max (μA)	at V _R (V)
		Min (V)	Nom (V)	Max (V)				
BZT52C2V0S	WY	1.8	2	2.15	5	100	120	0.5
BZT52C2V2S	WZ	2.08	2.2	2.33	5	100	120	0.7
BZT52C2V4S	WX	2.28	2.4	2.56	5	100	120	1
BZT52C2V7S	W1	2.5	2.7	2.9	5	110	120	1
BZT52C3V0S	W2	2.8	3	3.2	5	120	50	1
BZT52C3V3S	W3	3.1	3.3	3.5	5	130	20	1
BZT52C3V6S	W4	3.4	3.6	3.8	5	130	10	1
BZT52C3V9S	W5	3.7	3.9	4.1	5	130	5	1
BZT52C4V3S	W6	4	4.3	4.6	5	130	5	1
BZT52C4V7S	W7	4.4	4.7	5	5	130	2	1
BZT52C5V1S	W8	4.8	5.1	5.4	5	130	2	1.5
BZT52C5V6S	W9	5.2	5.6	6	5	80	1	2.5
BZT52C6V2S	WA	5.8	6.2	6.6	5	50	1	3
BZT52C6V8S	WB	6.4	6.8	7.2	5	30	0.5	3.5
BZT52C7V5S	WC	7	7.5	7.9	5	30	0.5	4
BZT52C8V2S	WD	7.7	8.2	8.7	5	30	0.5	5
BZT52C9V1S	WE	8.5	9.1	9.6	5	30	0.5	6
BZT52C10S	WF	9.4	10	10.6	5	30	0.1	7
BZT52C11S	WG	10.4	11	11.6	5	30	0.1	8
BZT52C12S	WH	11.4	12	12.7	5	35	0.1	9
BZT52C13S	WI	12.4	13	14.1	5	35	0.1	10
BZT52C15S	WJ	13.8	15	15.6	5	40	0.1	11
BZT52C16S	WK	15.3	16	17.1	5	40	0.1	12
BZT52C18S	WL	16.8	18	19.1	5	45	0.1	13
BZT52C20S	WM	18.8	20	21.2	5	50	0.1	15
BZT52C22S	WN	20.8	22	23.3	5	55	0.1	17
BZT52C24S	WO	22.8	24	25.6	5	60	0.1	19
BZT52C27S	WP	25.1	27	28.9	2	70	0.1	21
BZT52C30S	WQ	28	30	32	2	80	0.1	23
BZT52C33S	WR	31	33	35	2	80	0.1	25
BZT52C36S	WS	34	36	38	2	90	0.1	27
BZT52C39S	WT	37	39	41	2	100	0.1	30
BZT52C43S	WU	40	43	46	2	130	0.1	33
BZT52C47S	WV	44	47	50	2	150	0.1	36
BZT52C51S	WW	48	51	54	2	180	0.1	39
BZT52C56S	XW	52	56	60	2	200	0.1	43
BZT52C62S	6E	58	62	66	2	215	0.1	47
BZT52C68S	6F	64	68	72	2	240	0.1	52
BZT52C75S	6H	70	75	79	2	265	0.1	56

(1) V_{ZT} is tested with pulses (20 ms)

Typical Characteristics

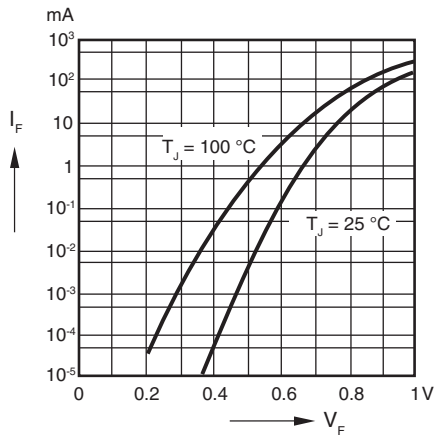

Fig. 1 - Forward characteristics

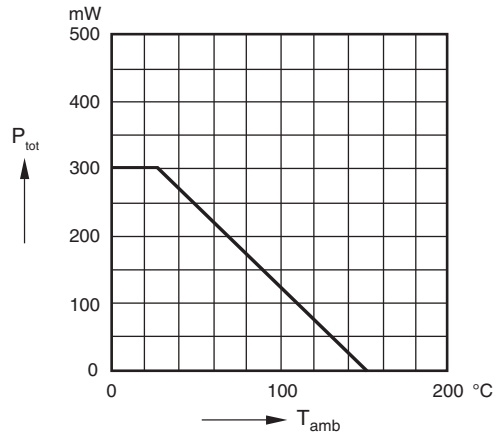

Fig. 2 - Admissible Power Dissipation vs. Ambient Temperature

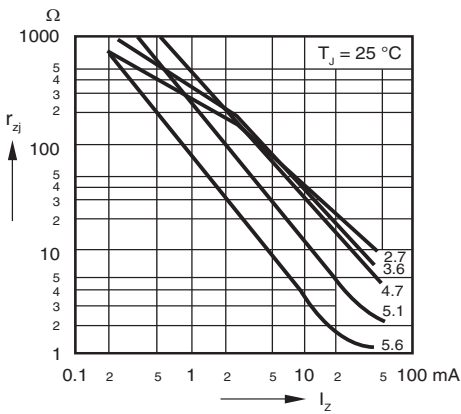

Fig. 3 - Dynamic Resistance vs. Zener Current

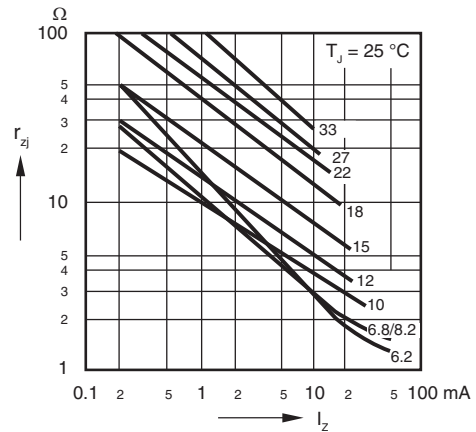

Fig. 4 - Dynamic Resistance vs. Zener Current

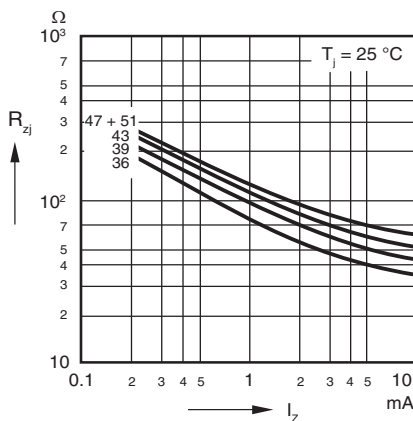

Fig. 5 - Dynamic Resistance vs. Zener Current

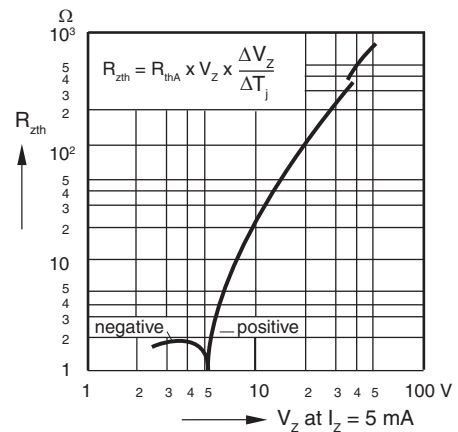

Fig. 6 - Thermal Differential Resistance vs. Zener Voltage

Typical Characteristics

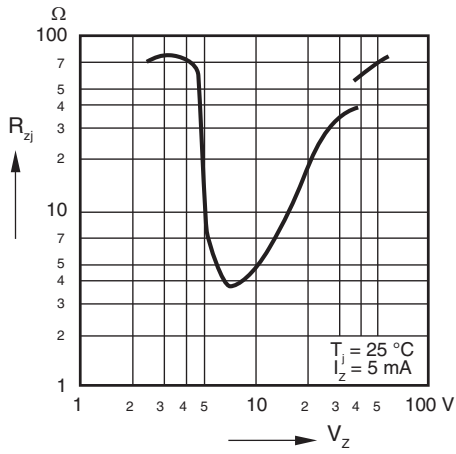

Fig. 7 - Dynamic Resistance vs. Zener Voltage

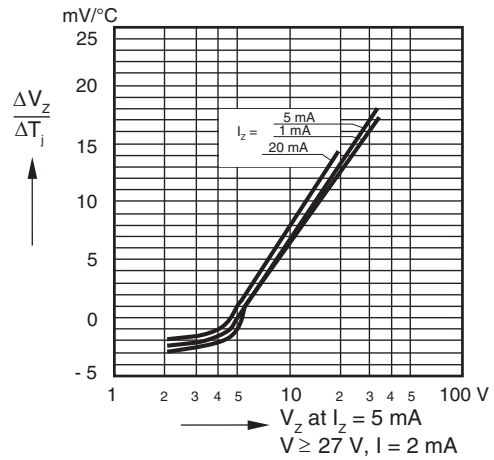

Fig. 8 - Temperature Dependence of Zener Voltage vs. Zener Voltage

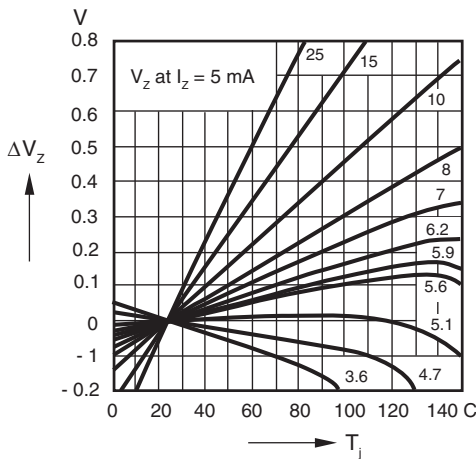

Fig. 9 - Change of Zener Voltage vs. Junction Temperature

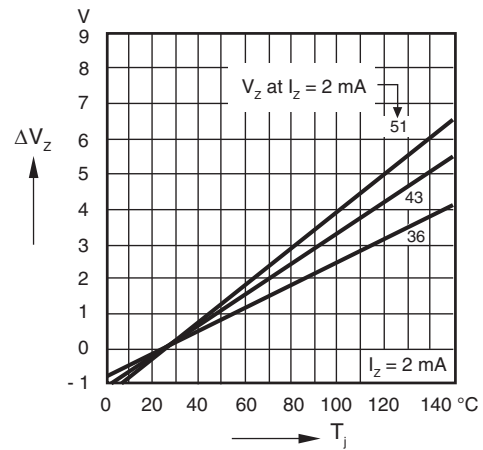

Fig. 10 - Change of Zener Voltage vs. Junction Temperature

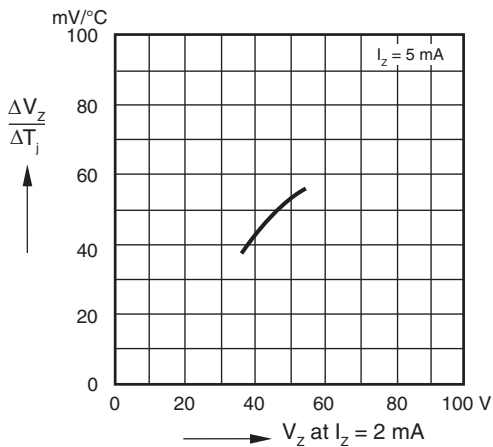

Fig. 11 - Temperature Dependence of Zener Voltage vs. Zener Voltage

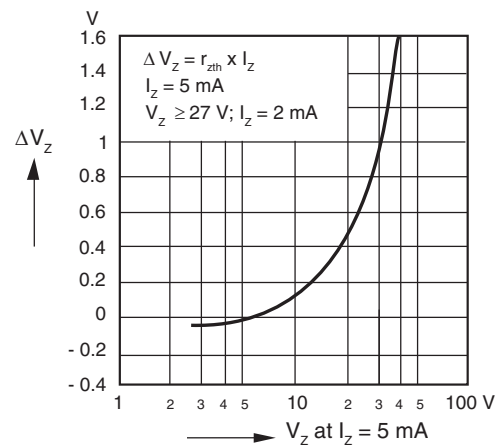

Fig. 12 - Change of Zener Voltage from Turn-on up to the Point of Thermal Equilibrium vs. Zener Voltage

Typical Characteristics

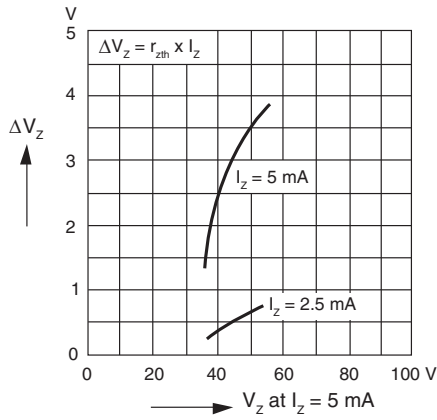

Fig. 13 - Change of Zener Voltage from Turn-on up to the Point of Thermal Equilibrium vs. Zener Voltage

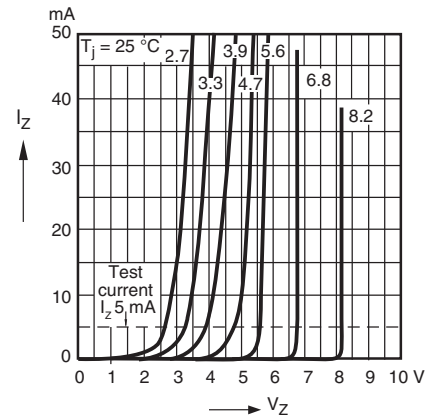

Fig. 14 - Breakdown Characteristics

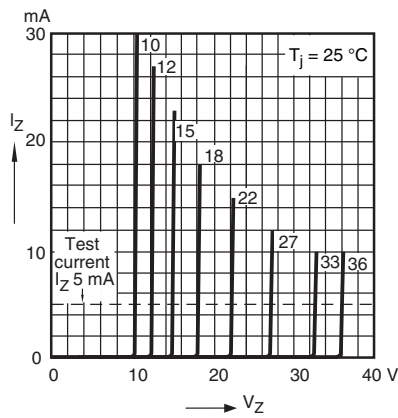

Fig. 15 - Breakdown Characteristics

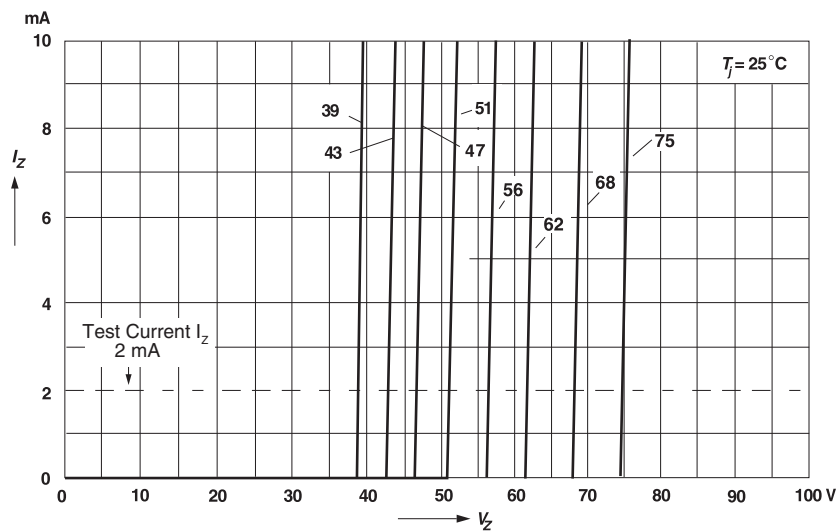

Fig. 16 - Breakdown Characteristics

The curve above is for reference only.



BZT52C-Series

Small Singnal Zener Diodes

Packing information

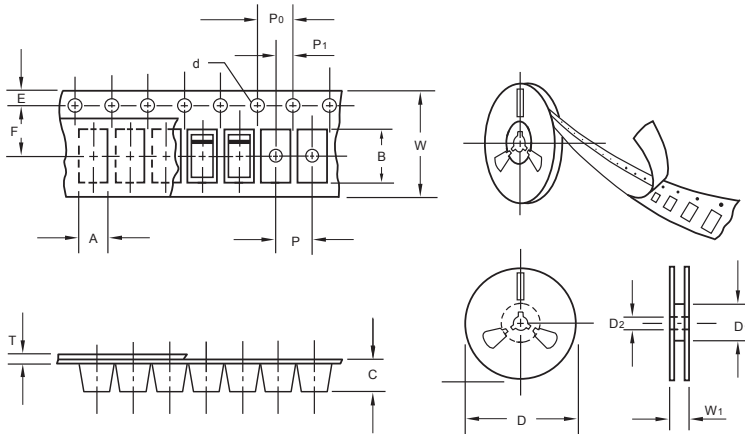

unit:mm

Item	Symbol	Tolerance	SOD-323
Carrier width	A	0.1	2.1
Carrier length	B	0.1	4.0
Carrier depth	C	0.1	1.60
Sprocket hole	d	0.05	1.55
7" Reel outside diameter	D	2.0	178.00
7" Reel inner diameter	D ₁	min	50.0
Feed hole diameter	D ₂	0.5	13.00
Sprocket hole position	E	0.1	1.75
Punch hole position	F	0.1	3.50
Punch hole pitch	P	0.1	4.00
Sprocket hole pitch	P ₀	0.1	4.00
Embossment center	P ₁	0.1	2.00
Overall tape thickness	T	0.1	0.25
Tape width	W	0.3	8.15
Reel width	W ₁	1.0	10.5

Note: Devices are packed in accordance with EIA standard RS-481-A and specifications listed above.

Reel packing

PACKAGE	REEL SIZE	REEL (pcs)	COMPONENT SPACING (m/m)	BOX (pcs)	INNER BOX (m/m)	REEL DIA. (m/m)	CARTON SIZE (m/m)	CARTON (pcs)	APPROX. GROSS WEIGHT (kg)
SOD-323	7"	3,000	4.0	45,000	210*208*203	178	430*430*235	180,000	

Suggested Pad Layout

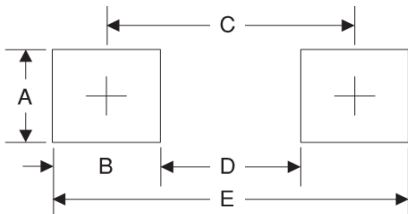

Symbol	Unit (mm)	Unit (inch)
A	0.7	0.028
B	0.7	0.028
C	2.15	0.085
D	1.8	0.071
E	2.85	0.112

X-ON Electronics

Largest Supplier of Electrical and Electronic Components

Click to view similar products for [Zener Diodes](#) category:

Click to view products by [Microdiode Electronics](#) manufacturer:

Other Similar products are found below :

[RKZ13B2KG#P1](#) [DL5234B](#) [EDZTE6113B](#) [1N4682](#) [1N4693](#) [1N4732A](#) [1N4736A](#) [1N4750A](#) [1N4759ARL](#) [1N5241B](#) [1N5365B](#) [1N5369B](#)
[1N747A](#) [1N964B](#) [1N966B](#) [1N968B](#) [1N972B](#) [JANS1N4974US](#) [JANTX1N5907](#) [1N4692](#) [1N4700](#) [1N4702](#) [1N4704](#) [1N4711](#) [1N4714](#)
[1N4745ARL](#) [1N4752ARL](#) [1N4760ARL](#) [1N5221B](#) [1N5242BTR](#) [1N5350B](#) [1N5352B](#) [1N961BRR1](#) [1N964BRL](#) [RKZ5.1BKU#P6](#)
[3SMAJ5946B-TP](#) [3SMAJ5950B-TP](#) [3SMBJ5925B-TP](#) [MMSZ5230BQ-13-F](#) [MMSZ5232BQ-13-F](#) [BZX84C7V5](#) [3SMAJ5945B-TP](#)
[3SMAJ5947B-TP](#) [3SMBJ5941B-TP](#) [DL4732A-T3](#) [DZ2S240M0L](#) [SMAZ27-TP](#) [ZMM5224B-7](#) [RD16UM-T1-A](#) [RD39S-T1-A](#)