

DFN2510 Plastic-Encapsulate Diodes

DESCRIPTION

ESD0524P is an ultra-low capacitance Transient Voltage Suppressor (TVS) designed to protection for high-speed data interfaces. With typical capacitance of 0.2pF (I/O to I/O) only, ESD0524P is designed to protect parasitic-sensitive systems against over-voltage and over-current transient events. It complies with IEC 61000-4-2 (ESD), Level 4(±15KV air, ±8KV contact discharge), IEC61000-4-4 (electrical fast transient-EFT) (40A, 5/50ns),very fast charged device model (CDM) ESD and cable discharge event(CDE), etc.

ESD0524P uses ultra-small DFN2510 package. Each ESD0524P device can protect four high-speed data lines. The combined features of ultra-low capacitance, ultra-small size and high ESD robustness make ESD0524P ideal for high-speed data ports and high-frequency lines (e.g., HDMI &DVI) applications. The low clamping voltage of the ESD0524P guarantees a minimum stress on the protected IC.

Features

- ◆ Transient protection for asymmetrical data lines
- ◆ IEC61000-4-2 (ESD) ±25kV (air), ±20kV (contact)
IEC61000-4-4 (EFT) 40A (5/50ns)
Cable Discharge Event(CDE)
- ◆ Package optimized for high-speed lines
- ◆ Protects four data lines
- ◆ Low capacitance:0.2pF (I/O to I/O)
- ◆ Low leakage current
- ◆ Low clamping voltage
- ◆ Each I/O pin can withstand over 1000 ESD strikes for ±8KV contact discharge

Applications

- ◆ Serial ATA
- ◆ High Definition Multi-Media Interface (HDMI)
- ◆ Desktops, Servers and Notebooks
- ◆ USB 2.0/3.0 Power and Data Line Protection

Mechanical Characteristics

- ◆ Package: DFN2510
- ◆ Flammability Rating: UL 94V-0
- ◆ Terminal: Matte tin plated.
- ◆ High temperature soldering guaranteed:
260 °C/10s
- ◆ Marking: 0524P
- ◆ Packaging: Tape and Reel

Package Outline & Pin Configuration

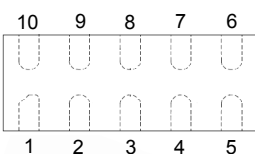

Pin	Identification
1, 2, 4, 5	Input Lines
3, 8	Ground
6, 7, 9, 10	Output Lines (No Internal Connection)



Circuit Diagram

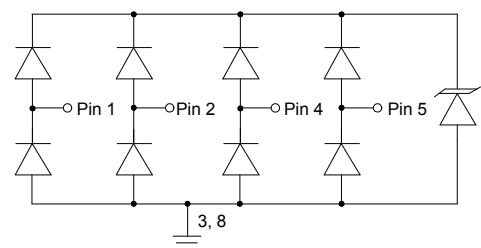

**Absolute Maximum Ratings ($T_A=25^{\circ}\text{C}$ unless otherwise specified)**

Symbol	Parameter	Value	Units
P_{PP}	Peak Pulse Power (8/20 μs)	60	W
V_{ESD}	ESD per IEC 61000-4-2 (Air) ESD per IEC 61000-4-2 (Contact)	± 25 ± 20	kV
T_{OPT}	Operating Temperature	-55/+125	$^{\circ}\text{C}$
T_{STG}	Storage Temperature	-55/+150	$^{\circ}\text{C}$

Electrical Characteristics ($T_A=25^{\circ}\text{C}$ unless otherwise specified)

Symbol	Parameter	Test Condition	Min	Typ	Max	Units
V_{RWM}	Reverse Working Voltage	Any I/O pin to GND			5.0	V
V_{BR}	Reverse Breakdown Voltage	$I_T = 1\text{mA}$ Any I/O pin to GND	6.0		9.0	V
I_R	Reverse Leakage Current	$V_{RWM} = 5\text{V}$ Any I/O pin to GND			1.0	μA
V_C	Clamping Voltage	$I_{PP} = 1\text{A}$, $t_p = 8/20\mu\text{s}$ Any I/O pin to GND			10	V
		$I_{PP} = 4\text{A}$, $t_p = 8/20\mu\text{s}$ Any I/O pin to GND			15	V
C_{ESD}	Capacitance	$V_R = 0\text{V}$, $f = 1\text{MHz}$ Between I/O and GND		0.4	0.5	pF
C_{ESD}	Capacitance	$V_R = 0\text{V}$, $f = 1\text{MHz}$ Between I/O and I/O		0.2	0.3	pF

Note:

- 1) I/O pins are pin 1,2,4,5, GND pins are pin 3,8.
- 2) The above data are for reference only.



ELECTRICAL CHARACTERISTICS CURVE

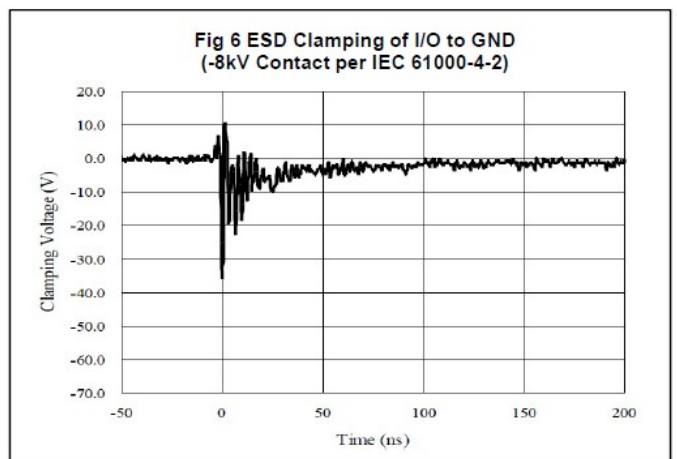
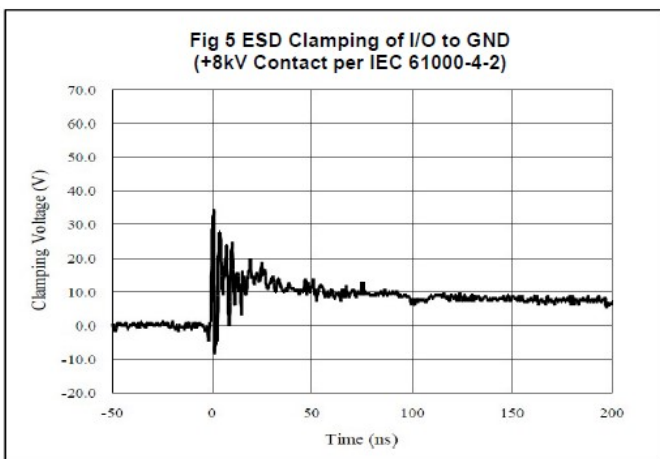
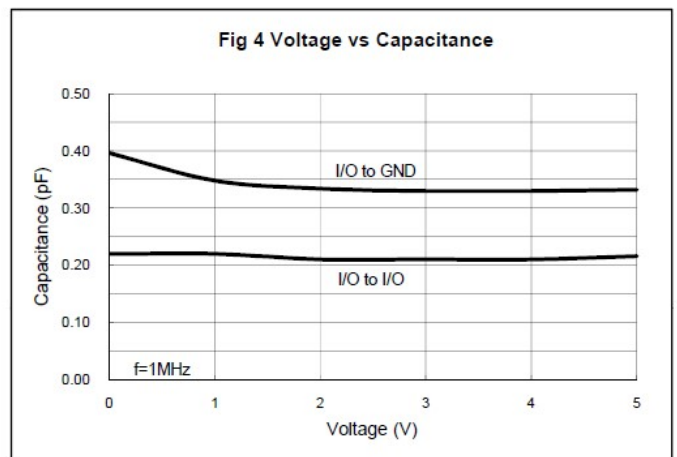
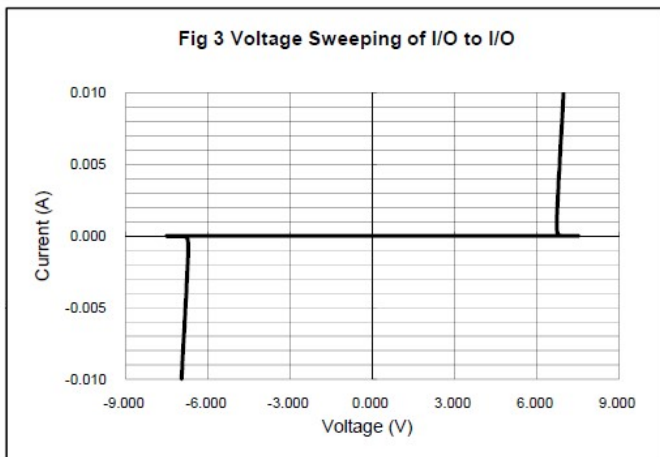
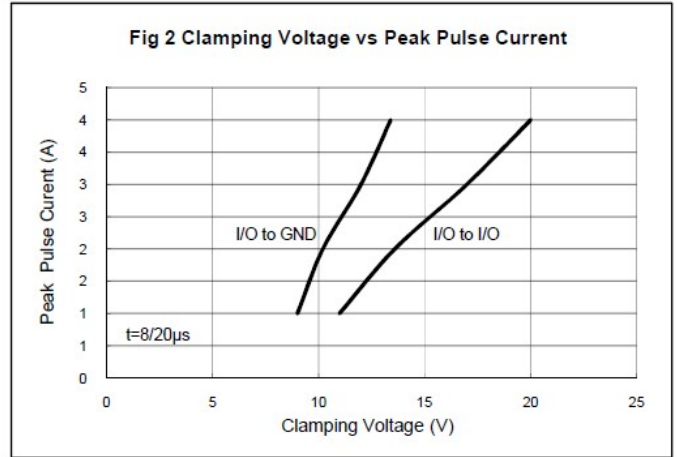
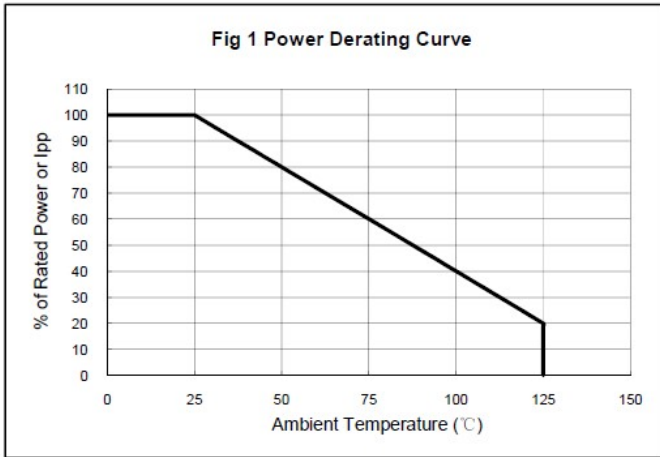

The curve above is for reference only.



Outlitne Drawing

DFN2510 Package Outline Dimensions

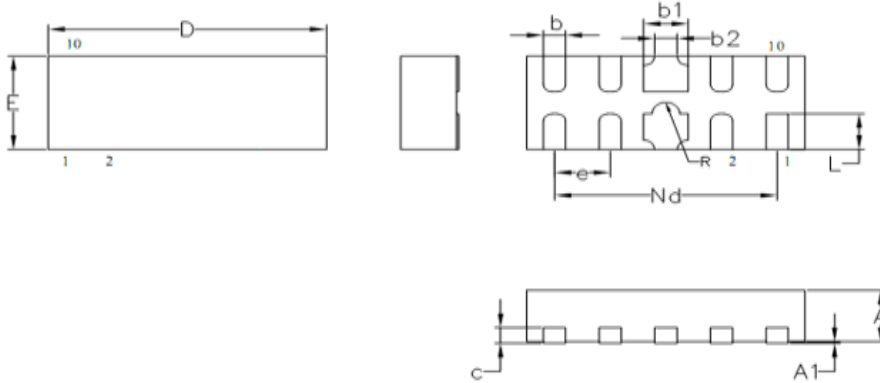

DIM	INCHES			MILLIMETERS		
	MIN	NOM	MAX	MIN	NOM	MAX
A	.018	.020	.022	0.45	0.50	0.55
A1	0.00	.001	.002	0.00	0.03	0.05
C	(0.005)			(0.15)		
b	.006	.008	.010	0.15	0.20	0.25
b1	.014	.016	.018	0.35	0.40	0.45
D	.096	.098	.100	2.45	2.50	2.55
E	.035	.039	.041	0.90	1.00	1.05
e	.020 BSC			0.50 BSC		
L	.012	.015	.017	0.30	0.38	0.43
Nd	0.079 BSC			2.00 BSC		
b2	.008 REF			0.20 REF		
R	.004	.005	0.06	0.10	.125	0.15

Suggested Pad Layout

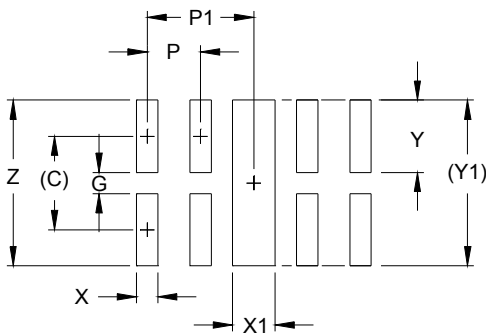

DIM	DIMENSIONS	
	INCHES	MILLIMETERS
C	(.034)	(0.875)
G	.008	0.20
P	.020	0.50
P1	.039	1.00
X	.008	0.20
X1	.016	0.40
Y	.027	0.675
Y1	(.061)	(1.55)
Z	.061	1.55

NOTES:

1. CONTROLLING DIMENSIONS ARE IN MILLIMETERS (ANGLES IN DEGREES).
2. THIS LAND PATTERN IS FOR REFERENCE PURPOSES ONLY. CONSULT YOUR MANUFACTURING GROUP TO ENSURE YOUR COMPANY'S MANUFACTURING GUIDELINES ARE MET.

Important Notice and Disclaimer

Microdiode Electronics (Jiangsu) reserves the right to make changes to this document and its products and specifications at any time without notice. Customers should obtain and confirm the latest product information and specifications before final design, purchase or use.

Microdiode Electronics (Jiangsu) makes no warranty, representation or guarantee regarding the suitability of its products for any particular purpose, not does Microdiode Electronics (Jiangsu) assume any liability for application assistance or customer product design. Microdiode Electronics (Jiangsu) does not warrant or accept any liability with products which are purchased or used for any unintended or unauthorized application.

No license is granted by implication or otherwise under any intellectual property rights of Microdiode Electronics (Jiangsu).

Microdiode Electronics (Jiangsu) products are not authorized for use as critical components in life support devices or systems without express written approval of Microdiode Electronics (Jiangsu).

X-ON Electronics

Largest Supplier of Electrical and Electronic Components

Click to view similar products for [ESD Suppressors / TVS Diodes](#) category:

Click to view products by [Microdiode Electronics](#) manufacturer:

Other Similar products are found below :

[NTE4902](#) [P4SMAJ15A](#) [P4SMAJ26A](#) [SMAJ400CA-TP](#) [TGL34-47CA](#) [ESDAULC45-1BF4](#) [SM1605E3/TR13](#) [SMF20A-TP](#) [P4SMAJ12A](#)
[CPDUR24V-HF](#) [CPDQC5V0USP-HF](#) [CPDQC5V0-HF](#) [MPLAD30KP280A](#) [MPLAD30KP45CAE3](#) [MMBZ27VCLQ-7-F](#) [MMAD1108/TR13](#)
[MPLAD30KP24A](#) [MPLAD30KP30CAE3](#) [ACPDQC5V0R-HF](#) [DFLT170A-7](#) [NTE4900](#) [NTE4926](#) [NTE4938](#) [JANTX1N6144A](#)
[JANTX1N6057A](#) [SMF22A-TP](#) [SMF12A-TP](#) [SLVU2.8-TP](#) [SMLJ6.5CA-TP](#) [SMAJ6.5CA-TP](#) [MMAD1108E3/TR13](#) [JANTX1N6160A](#)
[D5V0M1U2LP3-7](#) [SMAJ400A-TP](#) [AOZ8811DT-03](#) [AOZ8831DI-05](#) [AOZ8831DT-03](#) [SMAJ188CA](#) [3SMC33CA BK](#) [CPDQC3V3C-HF](#)
[CPDQC12VE-HF](#) [GRPADATAJANTX1N6041A](#) [MPLAD30KP170CA](#) [82357120100](#) [5.0SMLJ15CA-TP](#) [5KP18A-TP](#) [P6KE8.2A-TP](#)
[MPLAD30KP43CAE3](#) [SMAJ43A-TP](#) [D26V0H1U2LP16-7](#)