



# MBR1020 THRU MBR10100

## SCHOTTKY BARRIER RECTIFIER

Reverse Voltage - 20 to 100 Volts Forward Current - 10.0 Amperes

### TO-220AC

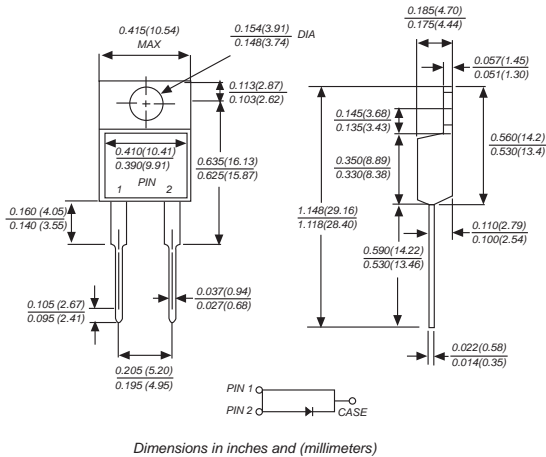

### FEATURES

- ◆ The plastic package carries Underwriters Laboratory Flammability Classification 94V-0
- ◆ Construction utilizes void-free molded plastic technique
- ◆ Low reverse leakage
- ◆ High forward surge current capability
- ◆ High temperature soldering guaranteed: 250°C, 0.25" (6.35mm) from case for 10 seconds

### MECHANICAL DATA

**Case:** TO-220AC molded plastic body  
**Terminals:** Leads solderable per MIL-STD-750, Method 2026  
**Polarity:** As marked  
**Mounting Position:** Any  
**Weight:** 0.064 ounce, 1.81 grams

### MAXIMUM RATINGS AND ELECTRICAL CHARACTERISTICS

Ratings at 25°C ambient temperature unless otherwise specified.  
 Single phase half-wave 60Hz, resistive or inductive load, for capacitive load current derate by 20%.

MDD Catalog Number	SYMBOLS	MBR 1020	MBR 1030	MBR 1040	MBR 1045	MBR 1050	MBR 1060	MBR 1070	MBR 1080	MBR 1090	MBR 10100	UNITS
Maximum repetitive peak reverse voltage	$V_{RRM}$	20	30	40	45	50	60	70	80	90	100	VOLTS
Maximum RMS voltage	$V_{RMS}$	14	21	28	32	35	42	49	56	63	70	VOLTS
Maximum DC blocking voltage	$V_{DC}$	20	30	40	45	50	60	70	80	90	100	VOLTS
Maximum average forward rectified current (see fig. 1)	$I_{(AV)}$	10.0										Amps
Peak forward surge current 8.3ms single half sine-wave superimposed on rated load (JEDEC Method)	$I_{FSM}$	150.0										Amps
Maximum instantaneous forward voltage at 10.0A	$V_F$	0.65			0.75		0.85					Volts
Maximum DC reverse current $T_A=25^\circ\text{C}$ at rated DC blocking voltage $T_A=100^\circ\text{C}$	$I_R$	1.0					50.0					mA
Typical junction capacitance (NOTE 1)	$C_J$	550					450					pF
Typical thermal resistance (NOTE 2)	$R_{\theta JC}$	3.0										°C/W
Operating junction temperature range	$T_J$	-50 to +125					-50 to +150					°C
Storage temperature range	$T_{STG}$	-50 to +150										°C

**Note:** 1. Measured at 1MHz and applied reverse voltage of 4.0V D.C.

2. Thermal resistance from junction to case



# RATINGS AND CHARACTERISTIC CURVES MBR1020 THRU MBR10100

AVERAGE FORWARD RECTIFIED CURRENT, AMPERES

FIG. 1- FORWARD CURRENT DERATING CURVE

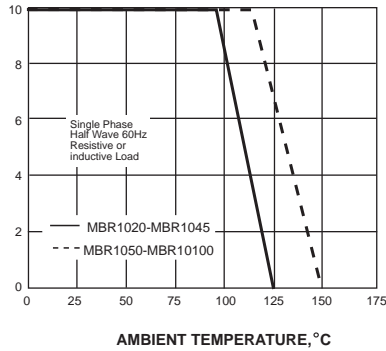

PEAK FORWARD SURGE CURRENT, AMPERES

FIG. 2-MAXIMUM NON-REPETITIVE PEAK FORWARD SURGE CURRENT

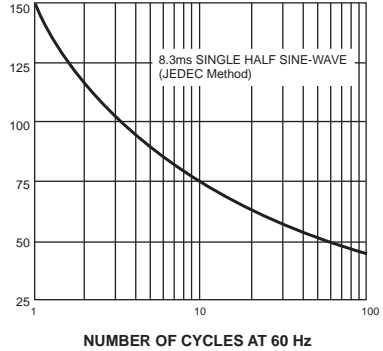
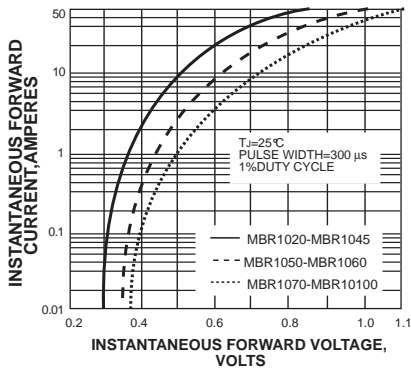

FIG. 3-TYPICAL INSTANTANEOUS FORWARD CHARACTERISTICS



INSTANTANEOUS REVERSE CURRENT, MILLIAMPERES

FIG. 4-TYPICAL REVERSE CHARACTERISTICS

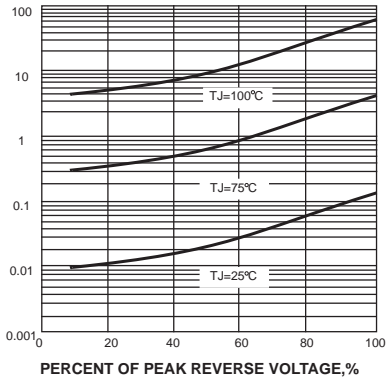
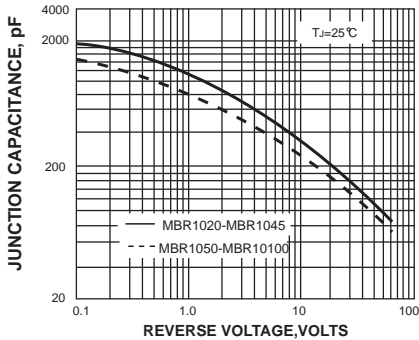
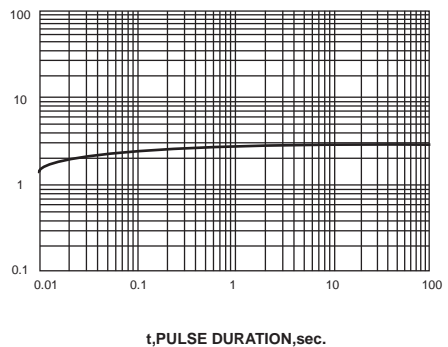

FIG. 5-TYPICAL JUNCTION CAPACITANCE



TRANSIENT THERMAL IMPEDANCE,  $^{\circ}\text{C}/\text{W}$

FIG. 6-TYPICAL TRANSIENT THERMAL IMPEDANCE



The cruve graph is for reference only, can't be the basis for judgment(曲线图仅供参考!)



## X-ON Electronics

Largest Supplier of Electrical and Electronic Components

*Click to view similar products for [Schottky Diodes & Rectifiers](#) category:*

*Click to view products by [Microdiode Electronics](#) manufacturer:*

Other Similar products are found below :

[MA4E2039](#) [MA4E2508M-1112](#) [MBR10100CT-BP](#) [MBR1545CT](#) [MMBD301M3T5G](#) [GS1JE-TP](#) [RB160M-50TR](#) [BAS 3010S-02LRH E6327](#)  
[BAT 54-02LRH E6327](#) [NSR05F40QNXT5G](#) [NSVR05F40NXT5G](#) [NTE555](#) [JANS1N6640](#) [SB07-03C-TB-H](#) [SB1003M3-TL-W](#)  
[SBAT54CWT1G](#) [SBM30-03-TR-E](#) [SK310-T](#) [SK33A-TP](#) [SK34B-TP](#) [SS3003CH-TL-E](#) [PDS3100Q-7](#) [GA01SHT18](#) [CRS10I30A\(TE85L,QM](#)  
[MA4E2501L-1290](#) [MBRB30H30CT-1G](#) [BAS 70-02L E6327](#) [DMJ3940-000](#) [SB007-03C-TB-E](#) [SB10015M-TL-E](#) [SB1003M3-TL-E](#) [SK32A-](#)  
[TP](#) [SK33B-TP](#) [SK35A-TP](#) [SK38B-LTP](#) [SK38B-TP](#) [NTE505](#) [NTSB30U100CT-1G](#) [VS-6CWQ10FNHM3](#) [CRG04\(T5L,TEMQ\)](#)  
[ACDBA1100LR-HF](#) [ACDBA1200-HF](#) [ACDBA140-HF](#) [ACDBA2100-HF](#) [ACDBA240-HF](#) [ACDBA3100-HF](#) [CDBQC0530L-HF](#) [BAT54-](#)  
[13-F](#) [ACDBA340-HF](#) [ACDBA260LR-HF](#)