

$V_{(BR)DSS}$	$R_{DS(on)Max}$	$I_D Max$
30V	9mΩ@10V	50A
	12mΩ@4.5V	

Features

- Trench Power LV MOSFET technology
- Excellent package for heat dissipation
- High density cell design for low $R_{DS(ON)}$
- Halogen Free

Marking

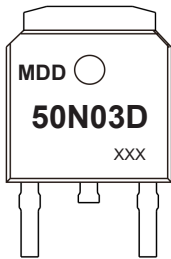

XXX: Date Code

TO-252

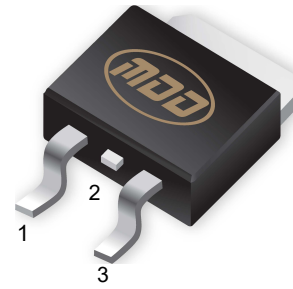

1. Gate
2. Drain
3. Source

Application

- High current load applications
- Load switching
- Hard switched and high frequency circuits
- Uninterruptible power supply

Equivalent Circuit

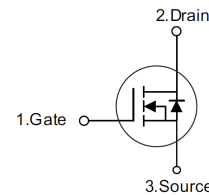

Absolute Maximum Ratings ($T_A=25^\circ\text{C}$ unless otherwise noted)

Parameter	Symbol	Value	Unit
Drain-Source Voltage	V_{DS}	30	V
Gate-Source Voltage	V_{GS}	±20	V
Continuous Drain Current	I_D	50	A
Pulsed Drain Current (Note 1)	I_{DM}	150	A
Avalanche Energy	Single Pulsed (Note 2)	E_{AS}	53 mJ
Power Dissipation	P_D	28	W
Thermal Resistance Junction-to-Case(Note 3)	$R_{\theta JC}$	4.4	$^\circ\text{C}/\text{W}$
Junction Temperature	T_J	150	$^\circ\text{C}$
Storage Temperature	T_{stg}	-50 ~ +150	$^\circ\text{C}$

Notes: 1.Pulse Test: Pulse Width≤300us,Duty cycle ≤2%.

2. $T_J=25^\circ\text{C}$, $V_{DD}=25\text{V}$, $V_G=10\text{V}$, $L=0.5\text{mH}$, $I_{AS}=14.5\text{A}$

3. $R_{\theta JA}$ is the sum of the junction-to-case and case-to-ambient thermal resistance, where the case thermal reference is defined as the solder mounting surface of the drain pins. $R_{\theta JC}$ is guaranteed by design, while $R_{\theta JA}$ is determined by the board design. The maximum rating presented here is based on mounting on a 1 in 2 pad of 2oz copper.



Ta = 25°C unless otherwise specified

Symbol	Parameter	Condition	Min	Typ	Max	Unit
$V_{(BR)DSS}$	Drain-Source Breakdown Voltage	$V_{GS}=0V, I_D=250\mu A$	30	--	--	V
I_{DSS}	Drain-Source Leakage Current	$V_{DS}=30V, V_{GS}=0V$	--	--	1	μA
I_{GSS}	Gate-Source Leakage Current	$V_{GS}=\pm 20V, V_{DS}=0V$	--	--	± 100	nA
$V_{GS(TH)}$	Gate Threshold Voltage	$V_{DS}=V_{GS}, I_D=250\mu A$	1.0	1.5	2.2	V
$R_{DS(ON)}$	Drain-Source On-State Resistance	$V_{GS}=10V, I_D=20A$	--	6.5	9	m Ω
		$V_{GS}=4.5V, I_D=15A$	--	8.3	12	m Ω

Dynamic Electrical Characteristics

Symbol	Parameter	Condition	Min	Typ	Max	Unit
C_{iss}	Input Capacitance	$V_{DS}=15V$ $V_{GS}=0V$ $f=1MHz$	--	1015	--	pF
C_{oss}	Output Capacitance		--	201	--	pF
C_{riss}	Reverse Transfer Capacitance		--	164	--	pF
Q_g	Total Gate Charge	$V_{DS}=20V,$ $V_{GS}=10V,$ $I_D=20A$ (Note1,2)	--	23.6	--	nC
Q_{gs}	Gate Source Charge		--	3.9	--	nC
Q_{gd}	Gate Drain Charge		--	7	--	nC

Switching Characteristics

Symbol	Parameter	Condition	Min	Typ	Max	Unit
$t_{d(on)}$	Turn on Delay Time	$V_{DS}=20V,$ $V_{GS}=10V,$ $I_D=2A,$ $R_G=3\Omega$ (Note1,2)	--	7	--	ns
t_r	Turn on Rise Time		--	19	--	ns
$t_{d(off)}$	Turn Off Delay Time		--	24	--	ns
t_f	Turn Off Fall Time		--	24	--	ns

Source Drain Diode Characteristics

Symbol	Parameter	Condition	Min	Typ	Max	Unit
I_{SD}	Source drain current(Body Diode)		--	--	50	A
I_{SM}	Pulsed Current		--	--	150	A
V_{SD}	Drain-Source Diode Forward Voltage	$I_S=15A, V_{GS}=0V$	--	0.85	1.2	V
t_{rr}	Body Diode Reverse Recovery Time	$I_F=20A, V_{GS}=0V,$ $di/dt=100A/\mu s$	--	5	--	ns
Q_{rr}	Body Diode Reverse Recovery Charge		--	0.2	--	nC

Notes: 1.Pulse test ; Pulse width 300us, duty cycle 2%.
2.Essentially independent of operating temperature.

■ Typical Performance Characteristics

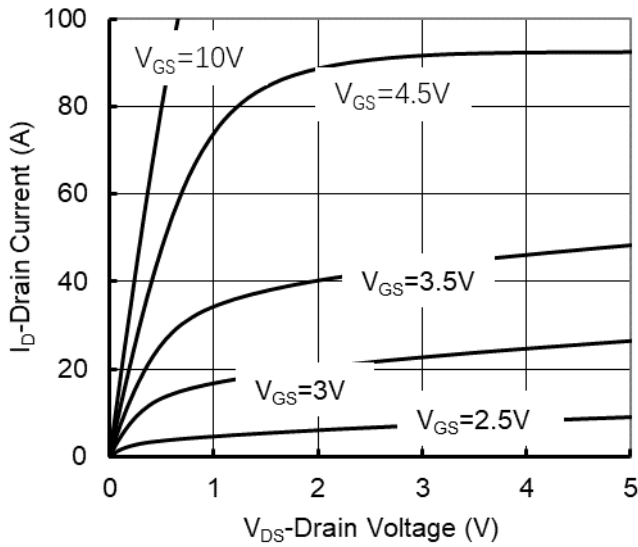

Figure 1. Output Characteristics

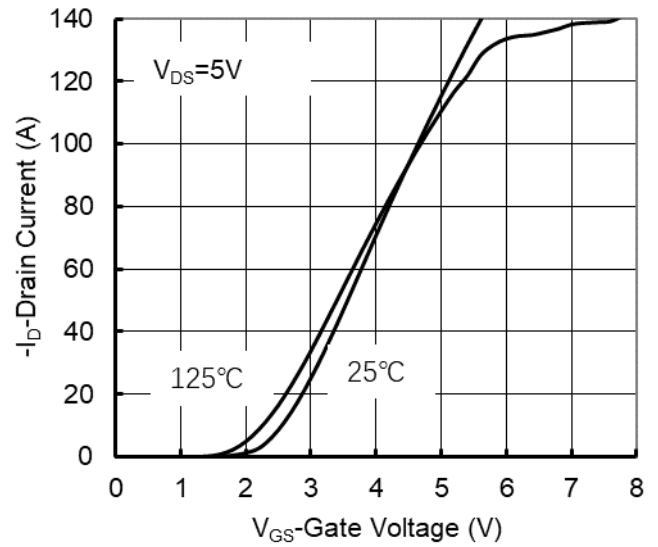

Figure 2. Transfer Characteristics

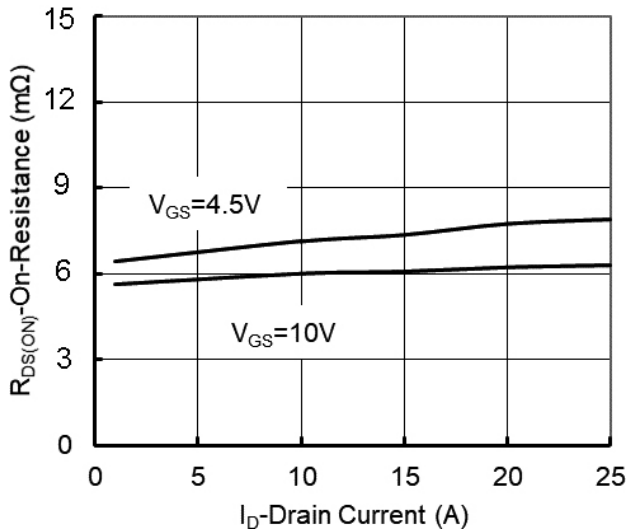

Figure 3. On-Resistance vs. Drain Current and Gate Voltage

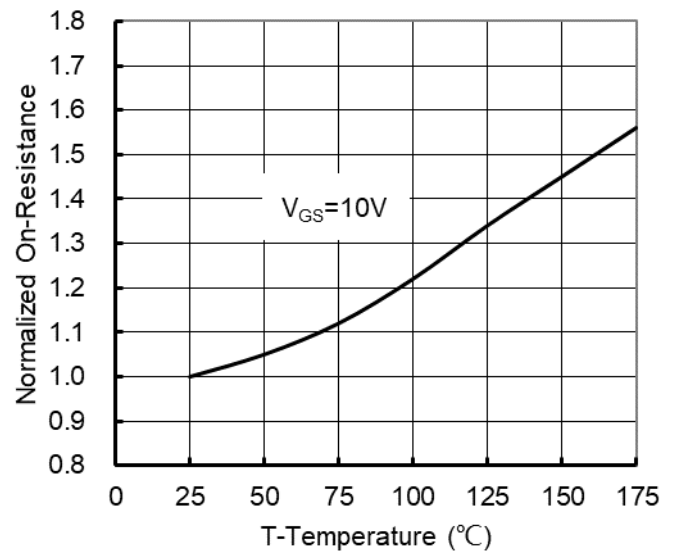

Figure 4. On-Resistance vs. Junction Temperature

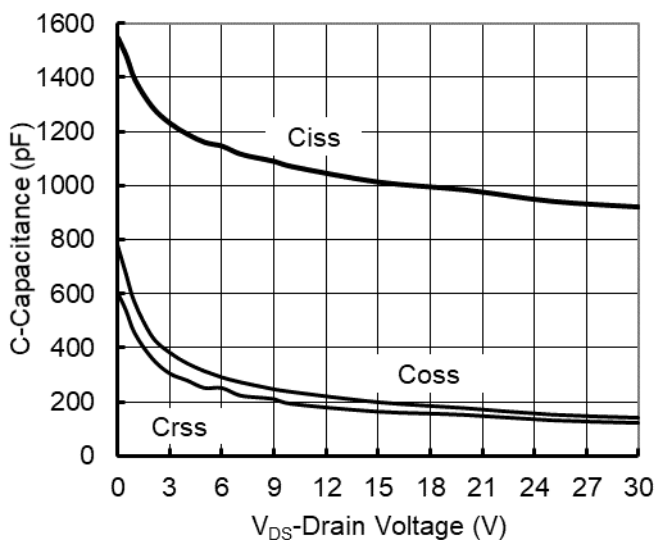

Figure 5. Capacitance Characteristics

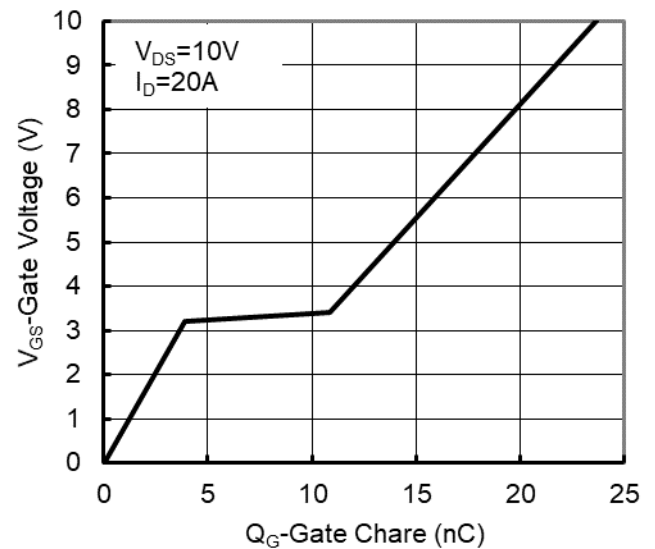

Figure 6. Gate Charge

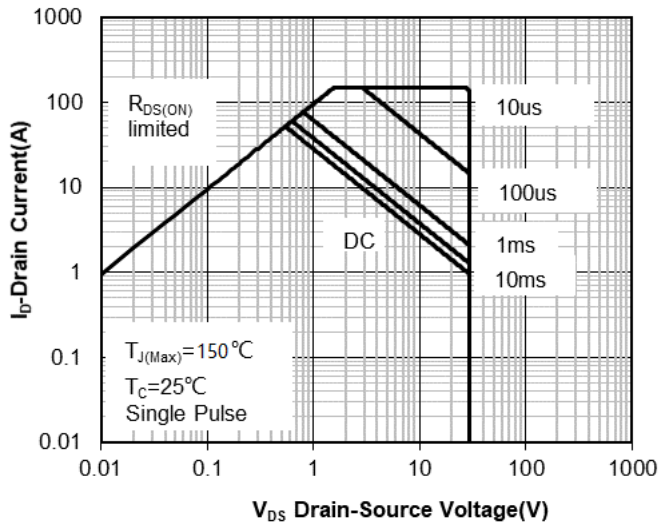

Figure 7. Safe Operation Area

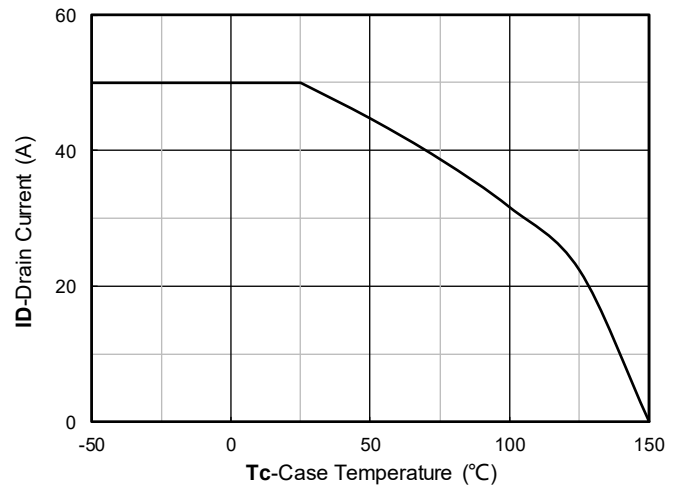

Figure 8. Maximum Continuous Drain Current vs Case Temperature

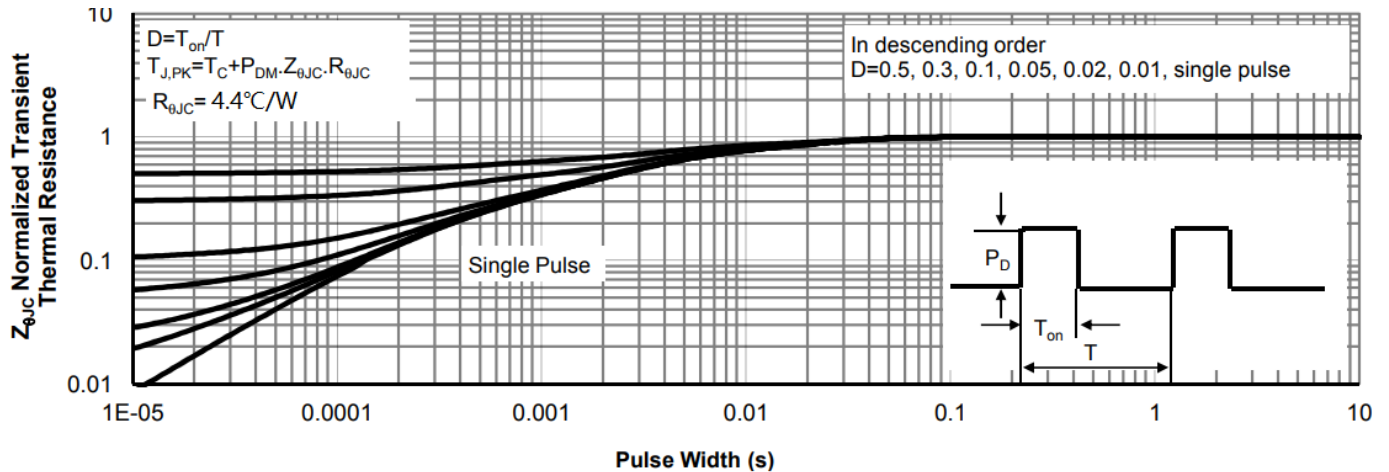
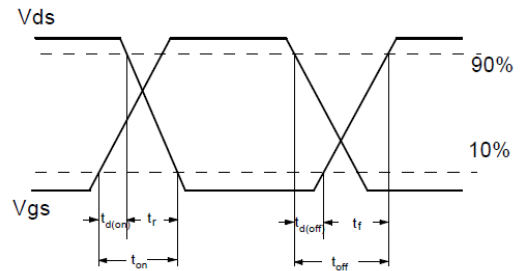
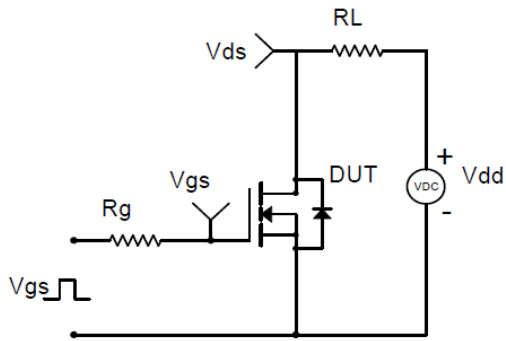
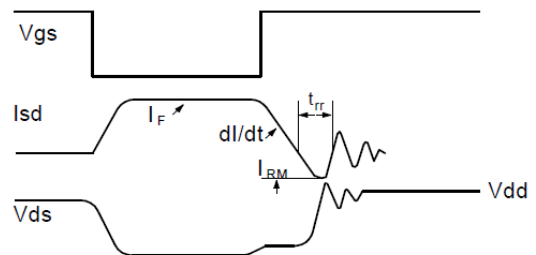
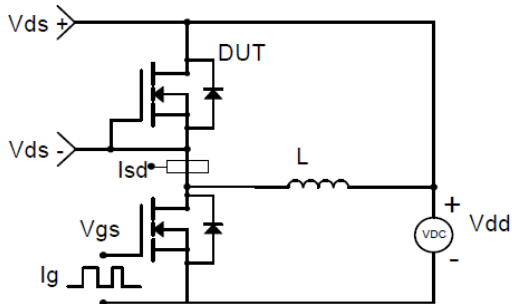

Figure 9. Normalized Maximum Transient Thermal Impedance



Resistive Switching Test Circuit & Waveforms



Diode Recovery Test Circuit & Waveforms

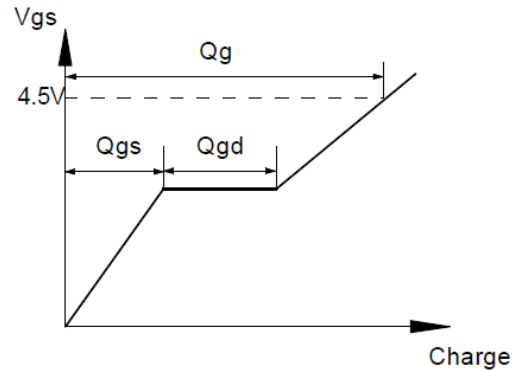
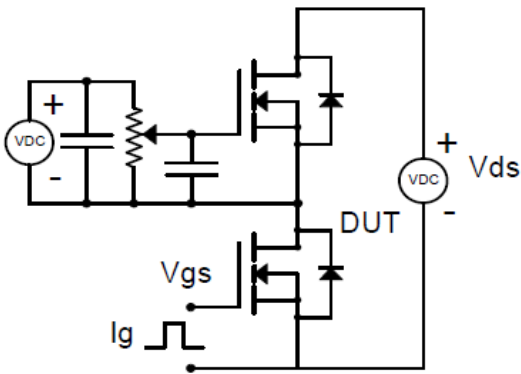

Gate Charge Test Circuit & Waveform

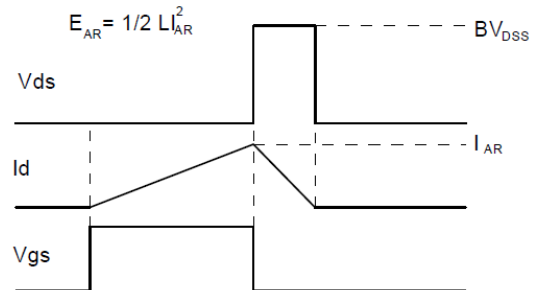
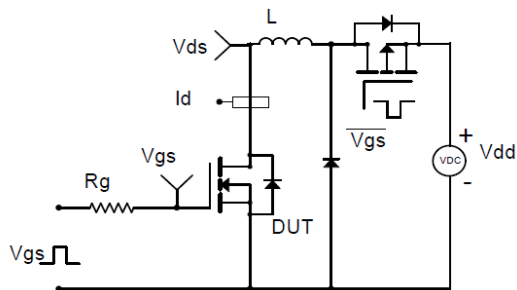

Unclamped Inductive Switching (UIS) Test Circuit & Waveforms

Outline Drawing

TO-252 Package Outline Dimensions

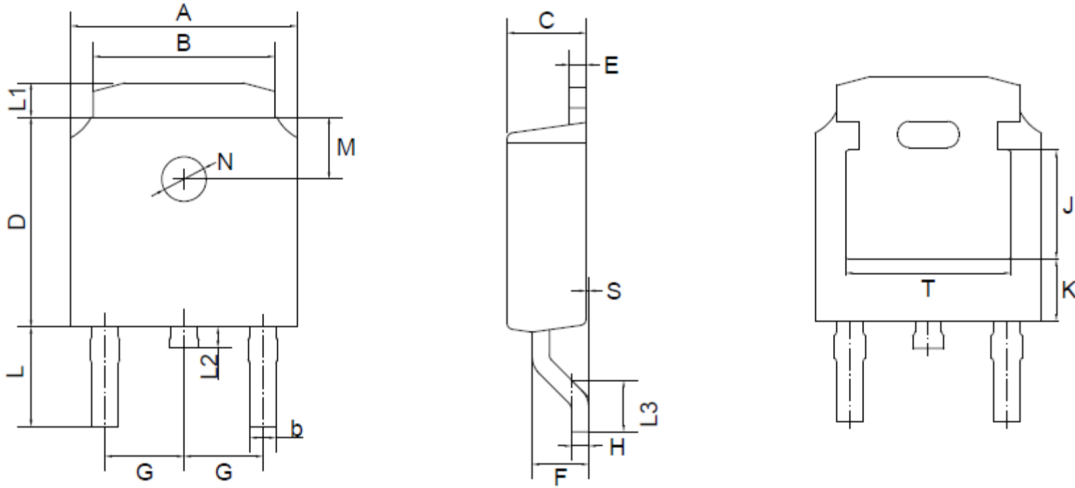

TO-252(D-PAK) mechanical data

UNIT		A	B	b	C	D	E	F	G	H	L	L1	L2	L3	S	M	N	J	K	T
mm	max	6.7	5.5	0.8	2.5	6.3	0.6	1.8	2.29	0.55	3.1	1.2	1.0	1.75	0.1	1.8	1.3	3.16	1.80	4.83
	min	6.3	5.1	0.3	2.1	5.9	0.4	1.3	TYPICAL	0.45	2.7	0.8	0.6	1.40	0.0	TYPICAL	TYPICAL	ref.	ref.	ref.
mil	max	264	217	31	98	248	24	71	90	22	122	47	39	69	4	71	51	124	71	190
	min	248	201	12	83	232	16	51	TYPICAL	18	106	31	24	55	0	TYPICAL	TYPICAL	ref.	ref.	ref.

Suggested Pad Layout

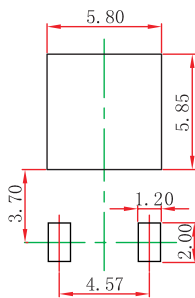

Note:

1. Controlling dimension: in/millimeters.
2. General tolerance: $\pm 0.05\text{mm}$.
3. The pad layout is for reference purposes only.

X-ON Electronics

Largest Supplier of Electrical and Electronic Components

Click to view similar products for [MOSFET](#) category:

Click to view products by [Microdiode Electronics](#) manufacturer:

Other Similar products are found below :

[IRFD120](#) [JANTX2N5237](#) [2SK2267\(Q\)](#) [BUK455-60A/B](#) [TK100A10N1,S4X\(S](#) [MIC4420CM-TR](#) [VN1206L](#) [NDP4060](#) [SI4482DY](#)
[IRS2092STRPBF-EL](#) [IPS70R2K0CEAKMA1](#) [TK31J60W5,S1VQ\(O](#) [TK31J60W,S1VQ\(O](#) [TK16J60W,S1VQ\(O](#) [2SK2614\(TE16L1,Q\)](#)
[DMN1017UCP3-7](#) [EFC2J004NUZTDG](#) [P85W28HP2F-7071](#) [DMN1053UCP4-7](#) [NTE2384](#) [DMC2700UDMQ-7](#) [DMN2080UCB4-7](#)
[DMN61D9UWQ-13](#) [US6M2GTR](#) [DMN31D5UDJ-7](#) [DMP22D4UFO-7B](#) [IPS60R3K4CEAKMA1](#) [DMN1006UCA6-7](#) [DMN16M9UCA6-7](#)
[STF5N65M6](#) [IRF40H233XTMA1](#) [STU5N65M6](#) [DMN6022SSD-13](#) [DMN13M9UCA6-7](#) [DMTH10H4M6SPS-13](#) [IPS60R360PFD7SAKMA1](#)
[DMN2990UFB-7B](#) [SSM3K35CT,L3F](#) [IPLK60R1K0PFD7ATMA1](#) [2N7002W-G](#) [MCAC30N06Y-TP](#) [IPWS65R035CFD7AXKSA1](#)
[MCQ7328-TP](#) [SSM3J143TU,LXHF](#) [DMN12M3UCA6-7](#) [PJMF280N65E1_T0_00201](#) [PJMF380N65E1_T0_00201](#)
[PJMF280N60E1_T0_00201](#) [PJMF600N65E1_T0_00201](#) [PJMF900N65E1_T0_00201](#)