



SOT-23 Plastic-Encapsulate Anode Zeners for ESD Protection Diodes

DESCRIPTION

The dual monolithic silicon Zener diodes are designed for applications requiring transient overvoltage protection capability. They are intended for use in voltage and ESD sensitive equipment such as computers, printers, business machines, communication systems, medical equipment and other applications. Their dual junction common anode design protects two separate lines using only one package. These devices ideal for situations where board space is at a premium.

Features

- ◆ SOT-23 package allows either two separate unidirectional configurations or a single bidirectional configuration.
- ◆ Working peak reverse voltage 3V to 22V
- ◆ Standard Zener breakdown voltage 5.6V to 27V
- ◆ Peak power 24 or Watts @ 1.0ms (unidirectional) per Figure 6 Waveform
- ◆ ESD Rating:
Class 3B (>16kV) per the Human Body Model
Class C (>400V) per Machine Model
- ◆ ESD Rating:
ESD Rating of IEC61000-4-2 level 4, ±30kV contact Discharge
- ◆ Low leakage < 5.0uA
- ◆ Meets MSL 1 Requirements

Schematic & Pin Configuration ROHS COMPLIANT

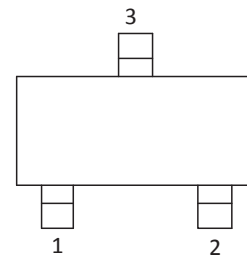

SOT23 (Top View)

Circuit Diagram

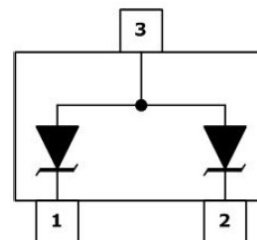

Pin	Description
1	cathode (diode 1)
2	cathode (diode 2)
3	common anode

Applications

- ◆ Computers
- ◆ Printers
- ◆ Business Machines
- ◆ Communication system
- ◆ Medical equipment

Mechanical Characteristics

- ◆ Package: SOT-23
- ◆ Flammability Rating: UL 94V-0
- ◆ Terminal: Matte tin plated.
- ◆ High temperature soldering guaranteed: 260 °C/10s
- ◆ Packaging: Tape and Reel
- ◆ Quantity per reel: 3,000pcs



Absolute Maximum Ratings ($T_A=25^\circ\text{C}$ unless otherwise specified)

Parameter	Symbol	Value	Unit
Peak Dissipation @1.0ms MMBZ5V6AL thru MMBZ9V1AL MMBZ12VAL thru MMBZ27VAL	P_{PK}	24 40	W
Total Power Dissipation	P_D	200	mW
Operating Temperature	T_{OPT}	-55 to +150	$^\circ\text{C}$
Storage Temperature	T_{STG}	-55 to +150	$^\circ\text{C}$
Lead Solder Temperature – Maximum (10 Second Duration)	T_L	260(10 sec.)	$^\circ\text{C}$

Electrical Characteristics ($T_A=25^\circ\text{C}$ unless otherwise specified)

24WATTS UNIDIRECTIONAL (Circuit tied to Pins 1 and 3 or Pins 2 to 3)

Part Number	Device Marking	V_{RWM}	I_R	V_{BR}			Z_{ZT}	Z_{ZK}		V_C		
		(V)	(μA)	(V)			(Ω)	(Ω)	(mA)	(V)	(A)	
			@ V_{RWM}	Min	Nom	Max	@ I_T	Max @ I_{ZT}	Max	@ I_{ZK}	Max	@ I_{PP}
MMBZ5V6AL	5A6	3.0	5.0	5.32	5.6	5.88	20	11	1600	0.25	8.0	3.0
MMBZ6V2AL	6A2	3.0	0.5	5.89	6.2	6.51	1.0	--	--	--	8.7	2.76
MMBZ6V8AL	6A8	4.5	0.5	6.46	6.8	7.14	1.0	--	--	--	9.6	2.5
MMBZ9V1AL	9A1	6.0	0.3	8.65	9.1	9.56	1.0	--	--	--	14	1.7

$V_F=0.9\text{V Max @ } I_F=10\text{mA}$

40WATTS UNIDIRECTIONAL (Circuit tied to Pins 1 and 3 or Pins 2 to 3)

Part Number	Device Marking	V_{RWM}	I_R	V_{BR}				V_C (note1)	
		(V)	(nA)	(V)			(mA)	(V)	(A)
			@ V_{RWM}	Min	Nom	Max	@ I_T	Max	@ I_{PP}
MMBZ12VAL	12A	8.5	200	11.40	12	12.60	1	17	2.35
MMBZ15VAL	15A	12.0	50	14.25	15	15.75	1	21	1.90
MMBZ18VAL	18A	14.5	50	17.10	18	18.90	1	25	1.60
MMBZ27VAL	27A	22.0	50	25.65	27	28.35	1	40	1.0

$V_F=0.9\text{V Max @ } I_F=10\text{mA}$

Note: 1. Surge Current waveform per Figure 5
2. The above data are for reference only.



ELECTRICAL CHARACTERISTICS CURVE

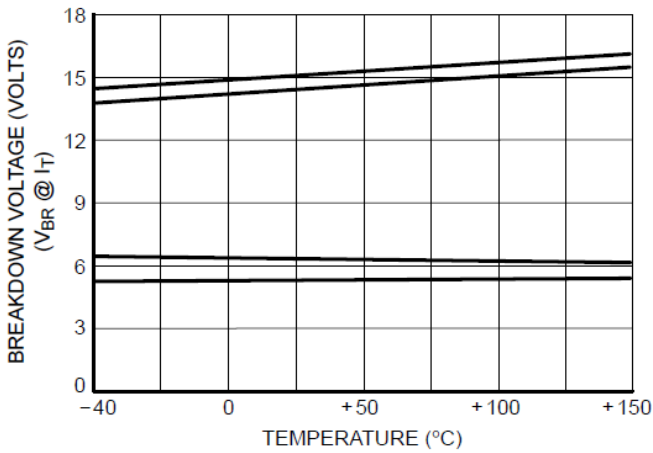

Figure 1. Typical Breakdown Voltage versus Temperature

(Upper curve for each voltage is bidirectional mode, lower curve is unidirectional mode)

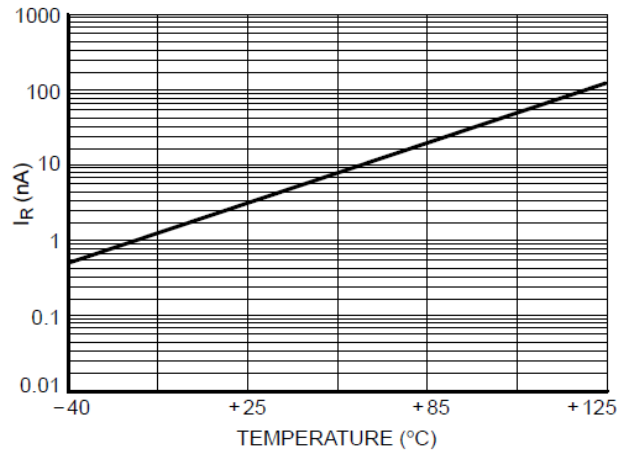

Figure 2. Typical Leakage Current versus Temperature

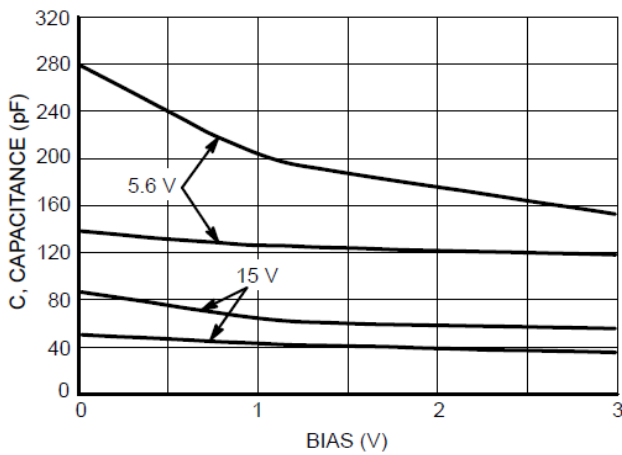

Figure 3. Typical Capacitance versus Bias Voltage

(Upper curve for each voltage is unidirectional mode, lower curve is bidirectional mode)

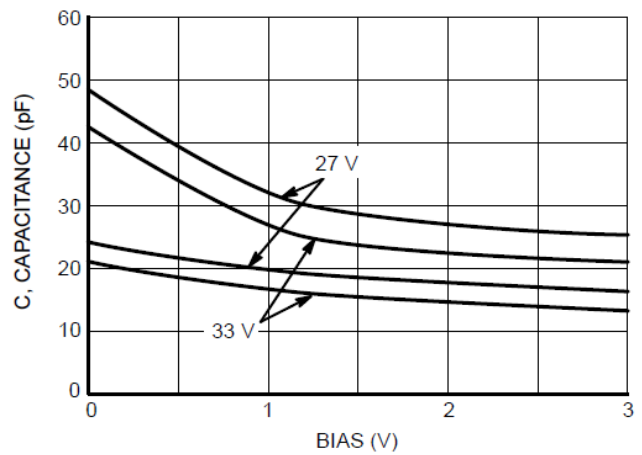

Figure 4. Typical Capacitance versus Bias Voltage

(Upper curve for each voltage is unidirectional mode, lower curve is bidirectional mode)

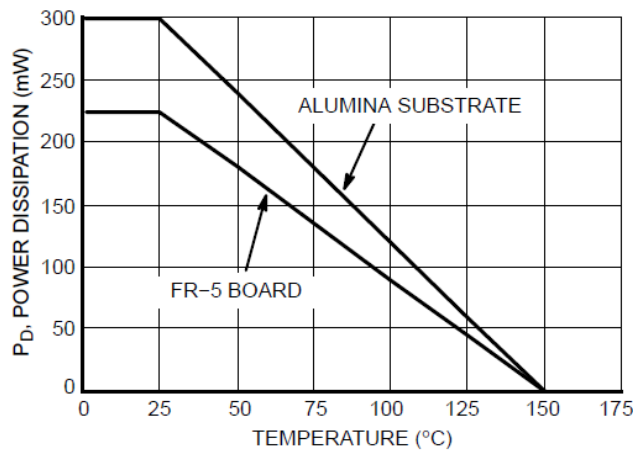

Figure 5. Steady State Power Derating Curve

The curve above is for reference only.



ELECTRICAL CHARACTERISTICS CURVE

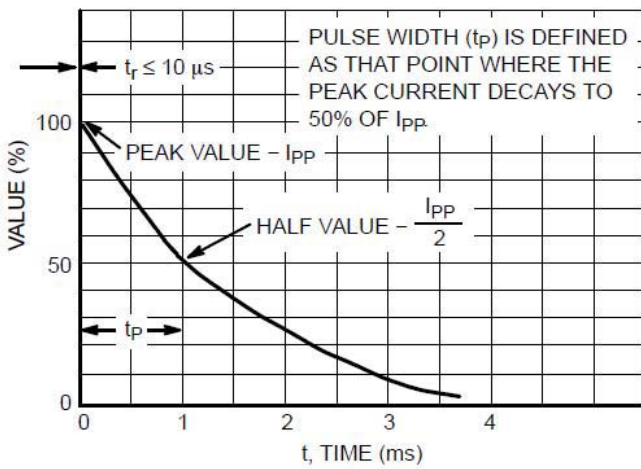

Figure 6. Pulse Waveform

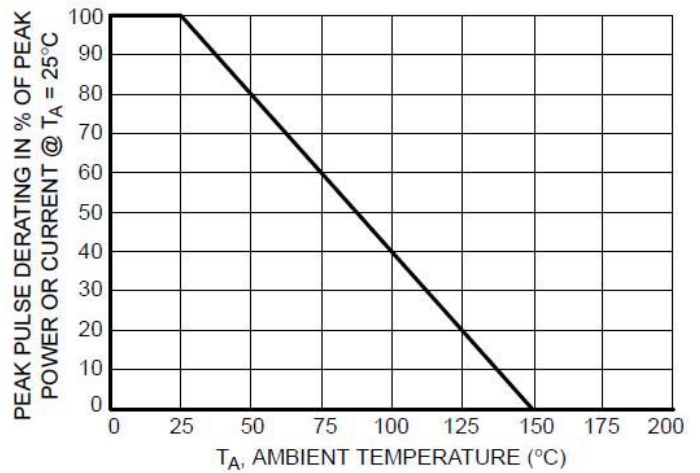

Figure 7. Pulse Derating Curve

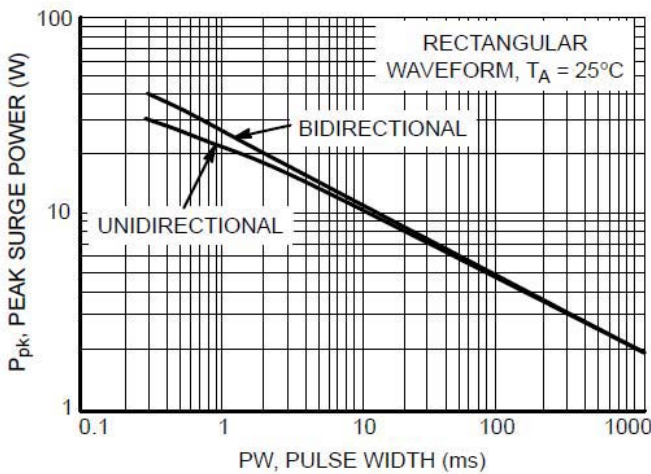

Figure 8. Maximum Non-repetitive Surge Power, P_{pk} versus PW

Power is defined as $V_{RSM} \times I_Z(pk)$ where V_{RSM} is the clamping voltage at $I_Z(pk)$.

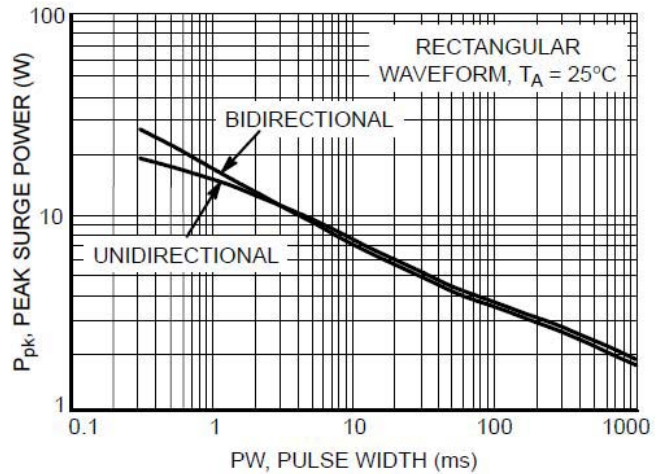

Figure 9. Maximum Non-repetitive Surge Power, $P_{pk(NOM)}$ versus PW

Power is defined as $V_Z(NOM) \times I_Z(pk)$ where $V_Z(NOM)$ is the nominal Zener voltage measured at the low test current used for voltage classification.

The curve above is for reference only.



Outline Drawing

SOT-23 Package Outline Dimensions

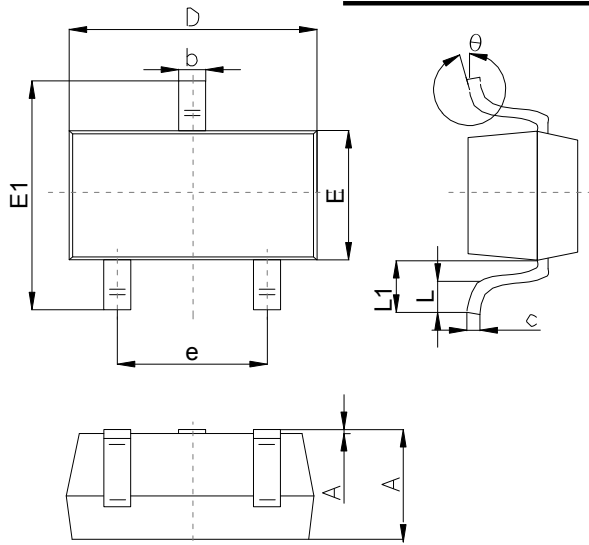

Symbol	Dimensions In Millimeters		
	Min	Typ	Max
A	1.00		1.40
A1			0.10
b	0.35		0.50
c	0.10		0.20
D	2.70	2.90	3.10
E	1.40		1.60
E1	2.4		2.80
e		1.90	
L	0.10		0.30
L1	0.4		
θ	0°		10°

Suggested Pad Layout

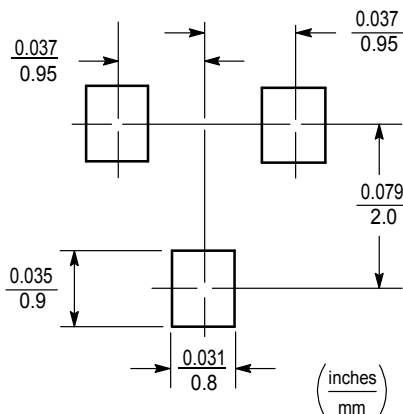

Note:

1. Controlling dimension:in/millimeters.
2. General tolerance: ±0.05mm.
3. The pad layout is for reference purposes only.

Important Notice and Disclaimer

Microdiode Electronics (Jiangsu) reserves the right to make changes to this document and its products and specifications at any time without notice. Customers should obtain and confirm the latest product information and specifications before final design, purchase or use.

Microdiode Electronics (Jiangsu) makes no warranty, representation or guarantee regarding the suitability of its products for any particular purpose, not does Microdiode Electronics (Jiangsu) assume any liability for application assistance or customer product design. Microdiode Electronics (Jiangsu) does not warrant or accept any liability with products which are purchased or used for any unintended or unauthorized application.

No license is granted by implication or otherwise under any intellectual property rights of Microdiode Electronics (Jiangsu).

Microdiode Electronics (Jiangsu) products are not authorized for use as critical components in life support devices or systems without express written approval of Microdiode Electronics (Jiangsu).



SOT-23 Tape and Reel

SOT-23 Embossed Carrier Tape

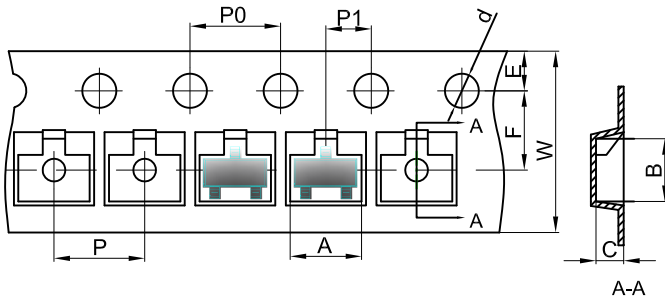

Packaging Description:

SOT-23 parts are shipped in tape. The carrier tape is made from a dissipative (carbon filled) polycarbonate resin. The cover tape is a multilayer film (Heat Activated Adhesive in nature) primarily composed of polyester film, adhesive layer, sealant, and anti-static sprayed agent. These reeled parts in standard option are shipped with 3,000 units per 7" or 17.8cm diameter reel. The reels are clear in color and is made of polystyrene plastic (anti-static coated).

Dimensions are in millimeter										
Pkg type	A	B	C	d	E	F	P0	P	P1	W
SOT-23	3.15	2.77	1.22	Ø1.50	1.75	3.50	4.00	4.00	2.00	8.00

SOT-23 Tape Leader and Trailer

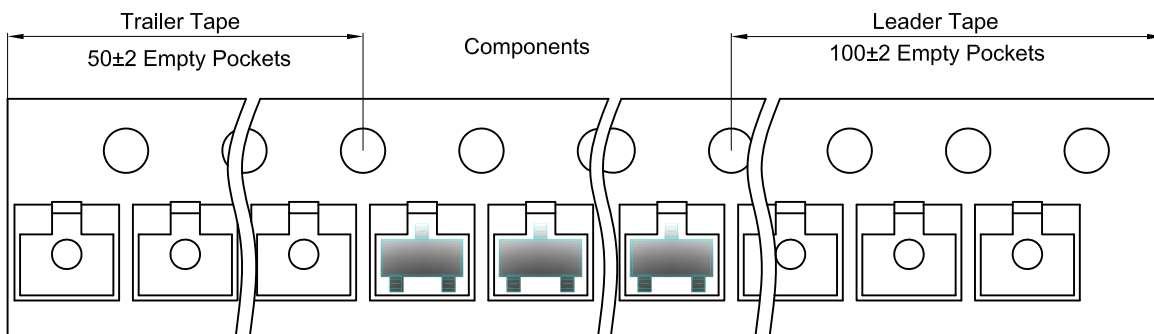

SOT-23 Reel

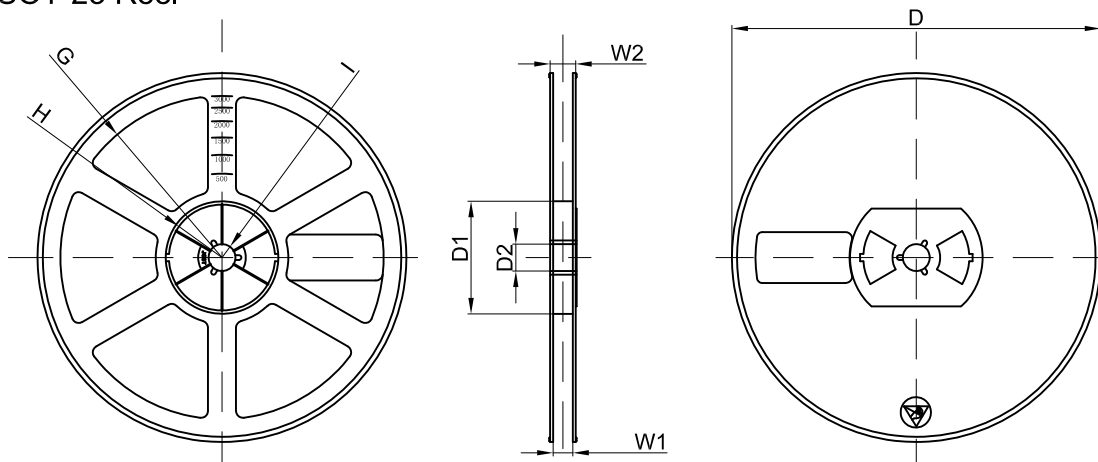

Dimensions are in millimeter								
Reel Option	D	D1	D2	G	H	I	W1	W2
7" Dia	Ø178.00	54.40	13.00	R78.00	R25.60	R6.50	9.50	12.30

REEL	Reel Size	Box	Box Size(mm)	Carton	Carton Size(mm)	G.W.(kg)
3000 pcs	7 Inch	45,000 pcs	203×203×195	180,000 pcs	438×438×220	

X-ON Electronics

Largest Supplier of Electrical and Electronic Components

Click to view similar products for [ESD Suppressors / TVS Diodes](#) category:

Click to view products by [Microdiode Electronics](#) manufacturer:

Other Similar products are found below :

[NTE4902](#) [P4SMAJ15A](#) [P4SMAJ26A](#) [SMAJ400CA-TP](#) [TGL34-47CA](#) [ESDAULC45-1BF4](#) [SM1605E3/TR13](#) [SMF20A-TP](#) [P4SMAJ12A](#)
[CPDUR24V-HF](#) [CPDQC5V0USP-HF](#) [CPDQC5V0-HF](#) [MPLAD30KP45CAE3](#) [MMBZ27VCLQ-7-F](#) [MMAD1108/TR13](#) [MPLAD30KP24A](#)
[ACPDQC5V0R-HF](#) [DFLT170A-7](#) [NTE4900](#) [NTE4926](#) [NTE4938](#) [SMF22A-TP](#) [SMF12A-TP](#) [SLVU2.8-TP](#) [SMLJ6.5CA-TP](#) [SMAJ6.5CA-TP](#)
[MMAD1108E3/TR13](#) [D5V0M1U2LP3-7](#) [SMAJ400A-TP](#) [AOZ8811DT-03](#) [AOZ8831DI-05](#) [AOZ8831DT-03](#) [SMAJ188CA](#) [3SMC33CA](#)
[BK](#) [CPDQC3V3C-HF](#) [CPDQC12VE-HF](#) [MPLAD30KP170CA](#) [82357120100](#) [5.0SMLJ15CA-TP](#) [5KP18A-TP](#) [P6KE8.2A-TP](#)
[MPLAD30KP43CAE3](#) [SMAJ43A-TP](#) [D5V0F6U8LP33-7](#) [TVS5501V10MUT5G](#) [5.0SMLJ24CA-TP](#) [SMAJ110CA-TP](#) [MPLAD15KP75CAE3](#)
[MMAD1103e3/TR13](#) [DFLT40AQ-7](#)