



SMAJ5.0 THRU SMAJ440CA

SURFACE MOUNT TRANSIENT VOLTAGE SUPPRESSOR

Stand-off Voltage: 5.0-440 Volts Peak pulse power: 400 Watts

DO-214AC/SMA

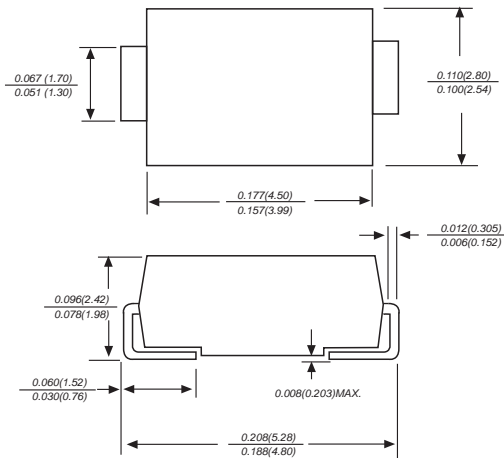

FEATURE

- ◆ For surface mounted applications in order to optimize board space
- ◆ Low profile package
- ◆ Built-in strain relief
- ◆ Glass passivated junction
- ◆ Low inductance
- ◆ Excellent clamping capability
- ◆ 400W peak pulse power capability at 10/1000 μ s waveform,
- ◆ repetition rate (duty cycle): 0.01%
- ◆ Fast response time
- ◆ Typical I_R less than 1 μ A above 10V
- ◆ High Temperature soldering: 260 $^{\circ}$ C/10 seconds at terminals
- ◆ Plastic package has underwriters laboratory flammability 94V-0

MECHANICAL DATA

Case: JEDEC DO-214AC. Molded plastic over glass passivated junction
 Terminal: Solder plated, solderable per MIL-STD-750, Method 2026
 Polarity: Color band denotes cathode except bi-directional models
 Standard Packaging: 12mm tape (EIA STD RS-481)
 Weight: 0.07g

APPLICATIONS

- ◆ I/O interface ◆ AC/DC power supply
- ◆ Low frequency signal transmission line (RS232, RS485, etc.)

MAXIMUM RATINGS AND CHARACTERISTICS

Ratings at 25 $^{\circ}$ C ambient temperature unless otherwise specified.

| | | | |
|---|-----------------|-------------|----------------|
| Peak pulse power dissipation at 10/1000 μ s waveform (Note1, Note2, Fig.1) | P_{PPM} | Minimum 400 | Watts |
| Peak pulse current of at 10/1000 μ s waveform (Note 1, Fig.3) | I_{PPM} | See Table | Amps |
| Steady state power dissipation at $T_A=50^{\circ}$ C (Fig.5) | $P_{M(AV)}$ | 3.3 | Watts |
| Peak forward surge current, 8.3ms single half sine-wave superimposed on rated load, (JEDEC Method) (Note3, Fig.6) | I_{FSM} | 40 | Amps |
| Operating junction and Storage Temperature Range. | T_J, T_{STG} | -65 to +150 | $^{\circ}$ C |
| Typical thermal resistance junction to lead | $R_{\theta JL}$ | 30 | $^{\circ}$ C/W |
| Typical thermal resistance junction to ambient | $R_{\theta JA}$ | 120 | $^{\circ}$ C/W |

Notes: 1. Non-repetitive current pulse, per Fig.3 and derated above $T_A=25^{\circ}$ C per Fig.2.

2. Mounted on 5.0mm \times 5.0mm (0.03mm thick) copper pads to each terminal.

3. 8.3ms single half sine-wave, or equivalent square wave, duty cycle=4 pulses per minutes maximum.



www.microdiode.com

Electrical Characteristics (TA=25°C)

| Part Number | | Device Marking Code | | Reverse Stand-Off Voltage | Breakdown Voltage @I _T | Test Current | Maximum Clamping Voltage @I _{PP} | Peak Pulse Current | Reverse Leakage @V _{RWM} |
|----------------|---------------|---------------------|----|---------------------------|-----------------------------------|--------------|---|--------------------|-----------------------------------|
| | | UNI | BI | | | | | | |
| Unidirectional | Bidirectional | | | | | | | | |
| SMAJ5.0A | SMAJ5.0CA | AE | WE | 5.0 | 6.40~7.00 | 10 | 9.2 | 43.5 | 800 |
| SMAJ6.0A | SMAJ6.0CA | AG | WG | 6.0 | 6.67~7.37 | 10 | 10.3 | 38.8 | 800 |
| SMAJ6.5A | SMAJ6.5CA | AK | WK | 6.5 | 7.22~7.98 | 10 | 11.2 | 35.7 | 500 |
| SMAJ7.0A | SMAJ7.0CA | AM | WM | 7.0 | 7.78~8.60 | 10 | 12.0 | 33.3 | 200 |
| SMAJ7.5A | SMAJ7.5CA | AP | WP | 7.5 | 8.33~9.21 | 1 | 12.9 | 31.0 | 100 |
| SMAJ8.0A | SMAJ8.0CA | AR | WR | 8.0 | 8.89~9.83 | 1 | 13.6 | 29.4 | 50 |
| SMAJ8.5A | SMAJ8.5CA | AT | WT | 8.5 | 9.44~10.40 | 1 | 14.4 | 27.8 | 20 |
| SMAJ9.0A | SMAJ9.0CA | AV | WV | 9.0 | 10.00~11.10 | 1 | 15.4 | 26.0 | 10 |
| SMAJ10A | SMAJ10CA | AX | WX | 10.0 | 11.10~12.30 | 1 | 17.0 | 23.5 | 5 |
| SMAJ11A | SMAJ11CA | AZ | WZ | 11.0 | 12.20~13.50 | 1 | 18.2 | 22.0 | 1 |
| SMAJ12A | SMAJ12CA | BE | XE | 12.0 | 13.30~14.70 | 1 | 19.9 | 20.1 | 1 |
| SMAJ13A | SMAJ13CA | BG | XG | 13.0 | 14.40~15.90 | 1 | 21.5 | 18.6 | 1 |
| SMAJ14A | SMAJ14CA | BK | XK | 14.0 | 15.60~17.20 | 1 | 23.2 | 17.2 | 1 |
| SMAJ15A | SMAJ15CA | BM | XM | 15.0 | 16.70~18.50 | 1 | 24.4 | 16.4 | 1 |
| SMAJ16A | SMAJ16CA | BP | XP | 16.0 | 17.80~19.70 | 1 | 26.0 | 15.4 | 1 |
| SMAJ17A | SMAJ17CA | BR | XR | 17.0 | 18.90~20.90 | 1 | 27.6 | 14.5 | 1 |
| SMAJ18A | SMAJ18CA | BT | XT | 18.0 | 20.00~22.10 | 1 | 29.2 | 13.7 | 1 |
| SMAJ20A | SMAJ20CA | BV | XV | 20.0 | 22.20~24.50 | 1 | 32.4 | 12.3 | 1 |
| SMAJ22A | SMAJ22CA | BX | XX | 22.0 | 24.40~26.90 | 1 | 35.5 | 11.3 | 1 |
| SMAJ24A | SMAJ24CA | BZ | XZ | 24.0 | 26.70~29.50 | 1 | 38.9 | 10.3 | 1 |
| SMAJ26A | SMAJ26CA | CE | YE | 26.0 | 28.90~31.90 | 1 | 42.1 | 9.5 | 1 |
| SMAJ28A | SMAJ28CA | CG | YG | 28.0 | 31.10~34.40 | 1 | 45.4 | 8.8 | 1 |
| SMAJ30A | SMAJ30CA | CK | YK | 30.0 | 33.30~36.80 | 1 | 48.4 | 8.3 | 1 |
| SMAJ33A | SMAJ33CA | CM | YM | 33.0 | 36.70~40.60 | 1 | 53.3 | 7.5 | 1 |
| SMAJ36A | SMAJ36CA | CP | YP | 36.0 | 40.00~44.20 | 1 | 58.1 | 6.9 | 1 |
| SMAJ40A | SMAJ40CA | CR | YR | 40.0 | 44.40~49.10 | 1 | 64.5 | 6.2 | 1 |
| SMAJ43A | SMAJ43CA | CT | YT | 43.0 | 47.80~52.80 | 1 | 69.4 | 5.8 | 1 |
| SMAJ45A | SMAJ45CA | CV | YV | 45.0 | 50.00~55.30 | 1 | 72.7 | 5.5 | 1 |
| SMAJ48A | SMAJ48CA | CX | YX | 48.0 | 53.30~58.90 | 1 | 77.4 | 5.2 | 1 |
| SMAJ51A | SMAJ51CA | CZ | YZ | 51.0 | 56.70~62.70 | 1 | 82.4 | 4.9 | 1 |
| SMAJ54A | SMAJ54CA | RE | ZE | 54.0 | 60.00~66.30 | 1 | 87.1 | 4.6 | 1 |
| SMAJ58A | SMAJ58CA | RG | ZG | 58.0 | 64.40~71.20 | 1 | 93.6 | 4.3 | 1 |
| SMAJ60A | SMAJ60CA | RK | ZK | 60.0 | 66.70~73.70 | 1 | 96.8 | 4.1 | 1 |
| SMAJ64A | SMAJ64CA | RM | ZM | 64.0 | 71.10~78.60 | 1 | 103.0 | 3.9 | 1 |
| SMAJ70A | SMAJ70CA | RP | ZP | 70.0 | 77.80~86.00 | 1 | 113.0 | 3.5 | 1 |
| SMAJ75A | SMAJ75CA | RR | ZR | 75.0 | 83.30~92.10 | 1 | 121.0 | 3.3 | 1 |
| SMAJ78A | SMAJ78CA | RT | ZT | 78.0 | 86.70~95.80 | 1 | 126.0 | 3.2 | 1 |
| SMAJ85A | SMAJ85CA | RV | ZV | 85.0 | 94.40~104.00 | 1 | 137.0 | 2.9 | 1 |
| SMAJ90A | SMAJ90CA | RX | ZX | 90.0 | 100.00~111.00 | 1 | 146.0 | 2.7 | 1 |
| SMAJ100A | SMAJ100CA | RZ | ZZ | 100.0 | 111.00~123.00 | 1 | 162.0 | 2.5 | 1 |
| SMAJ110A | SMAJ110CA | SE | VE | 110.0 | 122.00~135.00 | 1 | 177.0 | 2.3 | 1 |
| SMAJ120A | SMAJ120CA | SG | VG | 120.0 | 133.00~147.00 | 1 | 193.0 | 2.1 | 1 |

Electrical Characteristics (TA=25°C)

| Part Number | | Device Marking Code | | Reverse Stand-Off Voltage | Breakdown Voltage @I _T | Test Current | Maximum Clamping Voltage @I _{PP} | Peak Pulse Current | Reverse Leakage @V _{RWM} |
|----------------|---------------|---------------------|----|---------------------------|-----------------------------------|---------------------|---|---------------------|-----------------------------------|
| Unidirectional | Bidirectional | UNI | BI | V _{RWM} (V) | V _{BR} (V) | I _T (mA) | V _C (V) | I _{PP} (A) | I _R (μA) |
| SMAJ120A | SMAJ120CA | SG | VG | 120.0 | 133.00~147.00 | 1 | 193.0 | 2.1 | 1 |
| SMAJ130A | SMAJ130CA | SK | VK | 130.0 | 144.00~159.00 | 1 | 209.0 | 1.9 | 1 |
| SMAJ150A | SMAJ150CA | SM | VM | 150.0 | 167.00~185.00 | 1 | 243.0 | 1.6 | 1 |
| SMAJ160A | SMAJ160CA | SP | VP | 160.0 | 178.00~197.00 | 1 | 259.0 | 1.5 | 1 |
| SMAJ170A | SMAJ170CA | SR | VR | 170.0 | 189.00~209.00 | 1 | 275.0 | 1.5 | 1 |
| SMAJ180A | SMAJ180CA | ST | VT | 180.0 | 201.00~222.00 | 1 | 292.0 | 1.4 | 1 |
| SMAJ190A | SMAJ190CA | SU | YU | 190.0 | 211.00~233.00 | 1 | 308.0 | 1.3 | 1 |
| SMAJ200A | SMAJ200CA | SV | VV | 200.0 | 224.00~247.00 | 1 | 324.0 | 1.2 | 1 |
| SMAJ210A | SMAJ210CA | SW | YW | 210.0 | 237.00~263.00 | 1 | 340.0 | 1.2 | 1 |
| SMAJ220A | SMAJ220CA | GE | VX | 220.0 | 246.00~272.00 | 1 | 356.0 | 1.1 | 1 |
| SMAJ250A | SMAJ250CA | SZ | VZ | 250.0 | 279.00~309.00 | 1 | 405.0 | 1.0 | 1 |
| SMAJ300A | SMAJ300CA | TE | UE | 300.0 | 335.00~371.00 | 1 | 486.0 | 0.8 | 1 |
| SMAJ350A | SMAJ350CA | TG | UG | 350.0 | 391.00~432.00 | 1 | 567.0 | 0.7 | 1 |
| SMAJ400A | SMAJ400CA | TK | UK | 400.0 | 447.00~494.00 | 1 | 648.0 | 0.6 | 1 |
| SMAJ440A | SMAJ440CA | TM | UM | 440.0 | 492.00~543.00 | 1 | 713.0 | 0.6 | 1 |

Notes: For bidirectional type having V_{RWM} of 10V and less, the I_R limit is double.

Figure 1. Peak Pulse Power Rating Curve

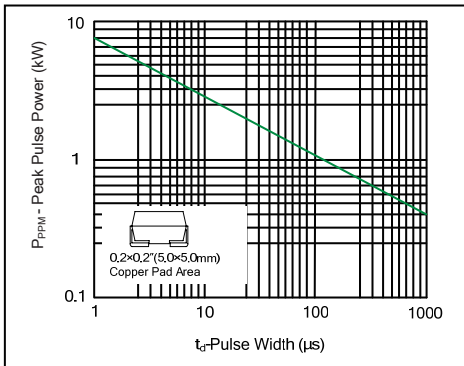

Figure 2. Pulse Derating Curve

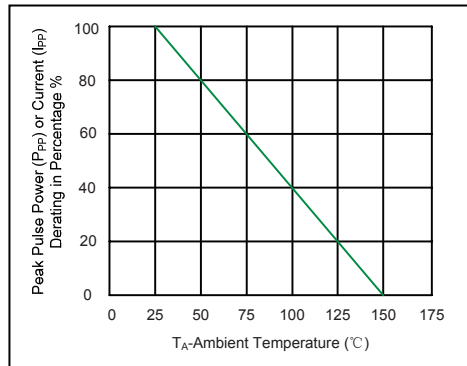

Figure 3. Pulse Waveform

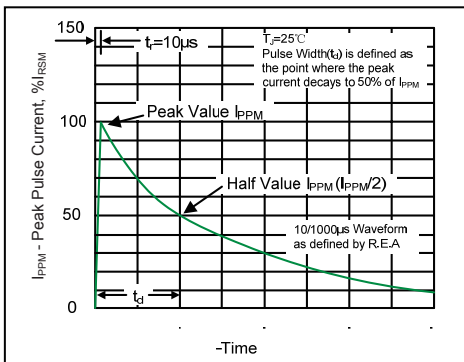

Figure 4. Typical Junction Capacitance

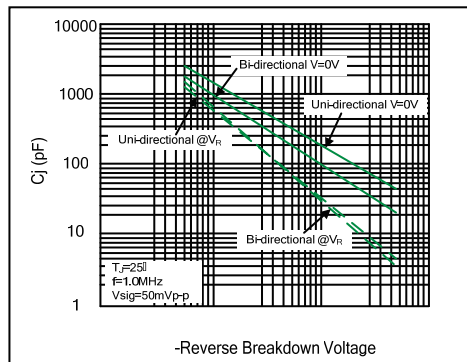

Figure 5. Steady State Power Dissipation Derating Curve

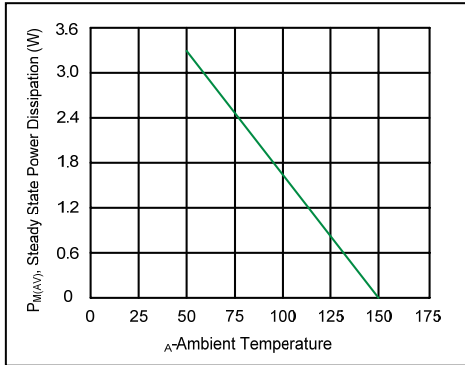
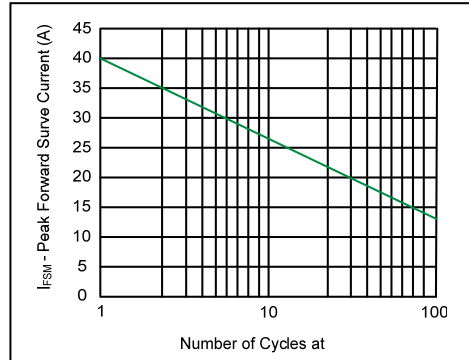
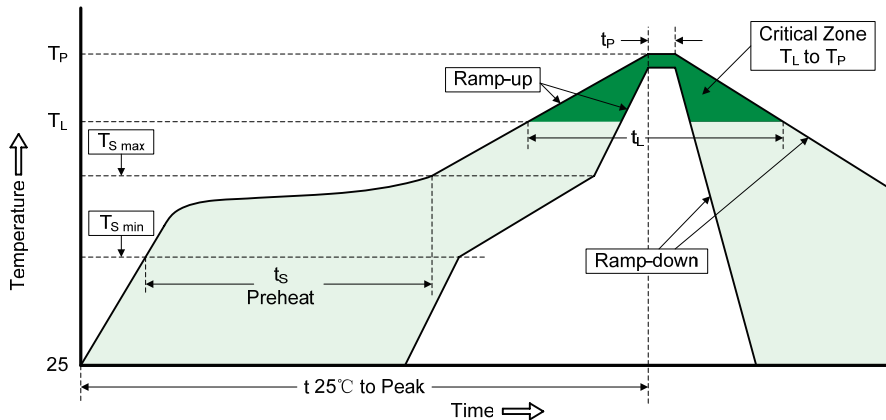

Figure 6. Maximum Non-Repetitive Forward Surge Current Uni-Directional Only



Reflow Soldering



Recommended Conditions

| Profile Feature | Pb-Free Assembly |
|--|------------------|
| Average ramp-up rate (T_L to T_P) | 3°C/second max. |
| Preheat | |
| -Temperature Min ($T_{S\ min}$) | 150°C |
| -Temperature Max ($T_{S\ max}$) | 200°C |
| -Time (min to max) (t_s) | 60-180 seconds |
| $T_{S\ max}$ to T_L | |
| -Ramp-up Rate | 3°C/second max. |
| Time maintained above: | |
| -Temperature (T_L) | 217°C |
| -Time (t_L) | 60-150 seconds |
| Peak Temperature (T_P) | 260°C |
| Time within 5°C of actual Peak Temperature (t_P) | 20-40 seconds |
| Ramp-down Rate | 6°C/second max. |
| Time 25°C to Peak Temperature | 8 minutes max. |

Marking Code

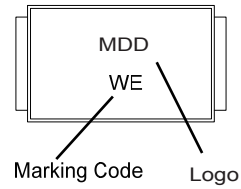
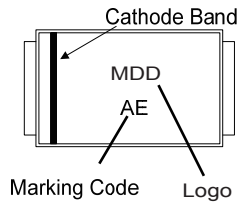

SMAJ XXX C A

5% V_{BR} Voltage Tolerance

Bidirectional

R_{WM} Voltage

Series Code

Packaging

Tape

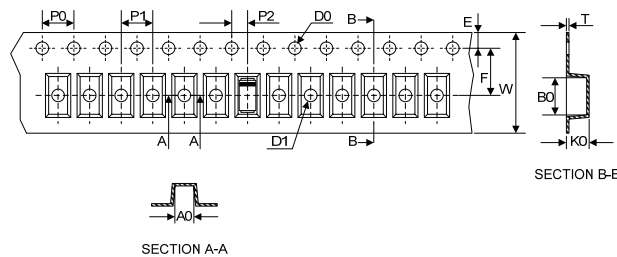

| Symbol | Dimension (mm) |
|--------|----------------|
|--------|----------------|

| | |
|----|------------|
| W | 12.00±0.20 |
| P0 | 4.00±0.10 |
| P1 | 4.00±0.10 |
| P2 | 2.00±0.10 |
| D0 | Φ1.5±0.10 |
| D1 | Φ1.5±0.10 |
| E | 1.75±0.10 |
| F | 5.50±0.05 |
| A0 | 2.79±0.10 |
| B0 | 5.33±0.10 |
| K0 | 2.55±0.15 |
| T | 0.25±0.05 |

7" Reel

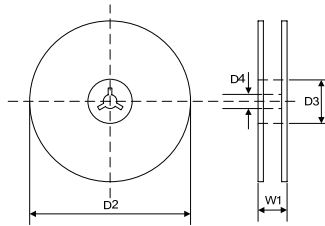

| | |
|----|------------|
| D2 | Φ178.0±2.0 |
| D3 | Φ50.0Min. |
| D4 | Φ13.0±0.5 |
| W1 | 16.0±2.0 |

Quantity: 2000PCS

13" Reel

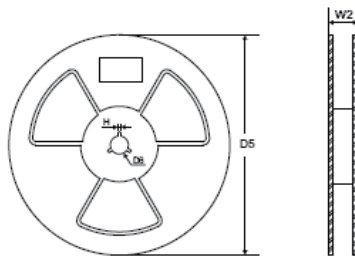

| | |
|----|------------|
| D5 | Φ330.0±2.0 |
| D6 | Φ13.5±0.5 |
| H | 2.5±1.0 |
| W2 | 16.0±2.0 |

Quantity: 5000PCS

X-ON Electronics

Largest Supplier of Electrical and Electronic Components

Click to view similar products for [ESD Suppressors / TVS Diodes](#) category:

Click to view products by [Microdiode Electronics](#) manufacturer:

Other Similar products are found below :

[60KS200C](#) [D18V0L1B2LP-7B](#) [D5V0F4U5P5-7](#) [DESD5V0U1BB-7](#) [NTE4902](#) [P4KE27CA](#) [P6KE11CA](#) [P6KE39CA-TP](#) [P6KE8.2A](#)
[SA110CA](#) [SA60CA](#) [SA64CA](#) [SMBJ12CATR](#) [SMBJ33CATR](#) [SMBJ8.0A](#) [ESD101-B1-02ELS E6327](#) [ESD105-B1-02EL E6327](#) [ESD112-B1-02EL E6327](#) [ESD119B1W01005E6327XTSA1](#) [ESD5V0L1B02VH6327XTSA1](#) [ESD7451N2T5G](#) [19180-510](#) [CPDT-5V0USP-HF](#)
[3.0SMCJ33CA-F](#) [3.0SMCJ36A-F](#) [HSPC16701B02TP](#) [D3V3Q1B2DLP3-7](#) [D55V0M1B2WS-7](#) [DESD5V0U1BL-7B](#) [DRTR5V0U4SL-7](#)
[SCM1293A-04SO](#) [ESD200-B1-CSP0201 E6327](#) [SM12-7](#) [SMF8.0A-TP](#) [SMLJ45CA-TP](#) [CEN955 W/DATA](#) [82350120560](#) [VESD12A1A-](#)
[HD1-GS08](#) [CPDUR5V0R-HF](#) [CPDQC5V0U-HF](#) [CPDQC5V0USP-HF](#) [CPDQC5V0-HF](#) [D1213A-01LP4-7B](#) [D1213A-02WL-7](#)
[MMAD1108/TR13](#) [5KP100A](#) [5KP15A](#) [5KP18A](#) [5KP48A](#) [5KP90A](#)