



SS32 THRU SS3200

Reverse Voltage - 20 to 200 Volts Forward Current - 3.0 Ampere

SURFACE MOUNT SCHOTTKY BARRIER RECTIFIER

Features

- ◆ The plastic package carries Underwriters Laboratory Flammability Classification 94V-0
- ◆ For surface mounted applications
- ◆ Metal silicon junction, majority carrier conduction
- ◆ Low power loss, high efficiency
- ◆ Built-in strain relief, ideal for automated placement
- ◆ High forward surge current capability
- ◆ High temperature soldering guaranteed:
250 °C/10 seconds at terminals

DO-214AC/SMA

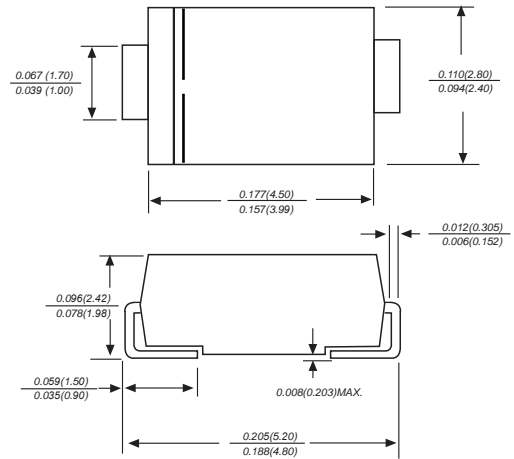

Dimensions in inches and (millimeters)

Mechanical Data

Case: JEDEC DO-214AC/SMA molded plastic body
 Terminals: Solderable per MIL-STD-750, Method 2026
 Polarity: Color band denotes cathode end Mounting
 Position: Any
 Weight: 0.0018 ounce, 0.064 grams

Maximum Ratings And Electrical Characteristics

Ratings at 25°C ambient temperature unless otherwise specified.

Single phase half-wave 60Hz, resistive or inductive load, for capacitive load current derate by 20%.

Parameter	SYMBOLS	MDD SS32	MDD SS33	MDD SS34	MDD SS35	MDD SS36	MDD SS38	MDD SS310	MDD SS3150	MDD SS3200	UNITS	
Marking Code												
Maximum repetitive peak reverse voltage	V_{RRM}	20	30	40	50	60	80	100	150	200	V	
Maximum RMS voltage	V_{RMS}	14	21	28	35	42	56	70	105	140	V	
Maximum DC blocking voltage	V_{DC}	20	30	40	50	60	80	100	150	200	V	
Maximum average forward rectified current at TL (see fig. 1)	$I_{(AV)}$	3.0									A	
Peak forward surge current 8.3ms single half sine-wave superimposed on rated load (JEDEC Method)	I_{FSM}	80									A	
Maximum instantaneous forward voltage at 3.0A	V_F	0.55			0.70			0.85		0.95	V	
Maximum DC reverse current $T_A=25^\circ\text{C}$ at rated DC blocking voltage $T_A=125^\circ\text{C}$	I_R	0.5						10		0.2	mA	
Typical junction capacitance (NOTE 1)	C_J	500					300					pF
Typical thermal resistance (NOTE 2)	$R_{\theta JA}$	55.0									°C/W	
Operating junction temperature range	T_J	-55 to +125					-55 to +150					°C
Storage temperature range	T_{STG}	-55 to +150									°C	

Note: 1. Measured at 1MHz and applied reverse voltage of 4.0V D.C.
 2. P.C.B. mounted with 0.2x0.2" (5.0x5.0mm) copper pad areas



SS32 THRU SS3200

Reverse Voltage - 20 to 200 Volts Forward Current - 3.0 Ampere

Typical Characteristics

Fig.1 Forward Current Derating Curve

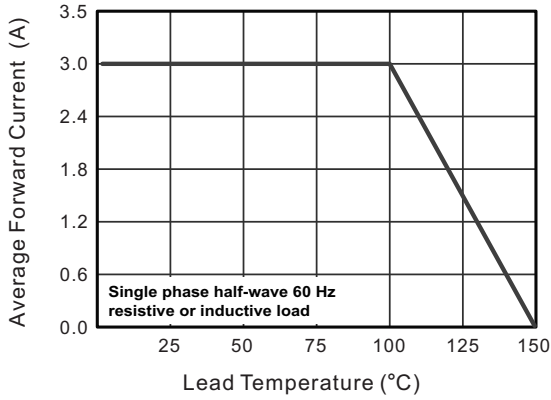

Fig.2 Typical Reverse Characteristics

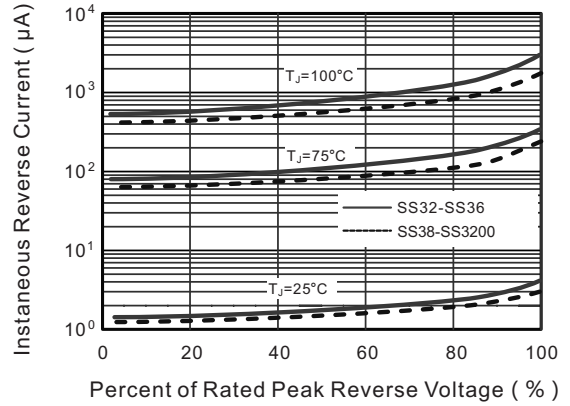

Fig.3 Typical Forward Characteristic

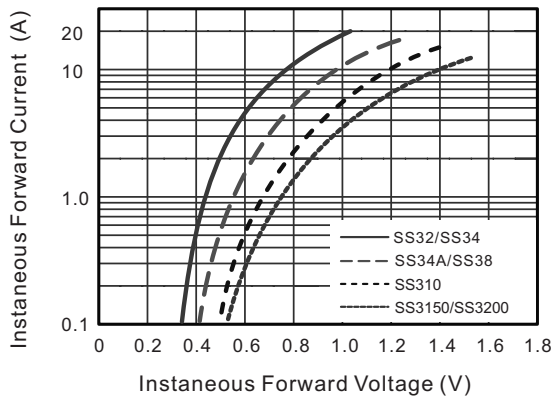

Fig.4 Typical Junction Capacitance

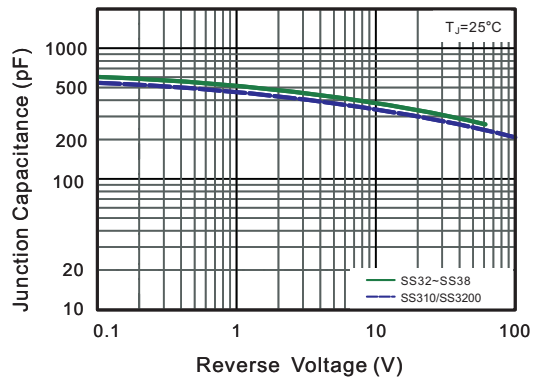

Fig.5 Maximum Non-Repetitive Peak Forward Surge Current

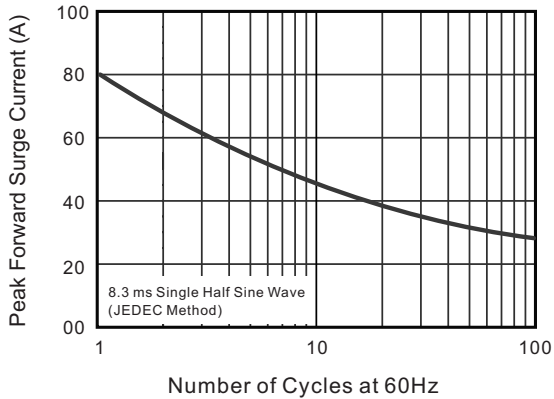
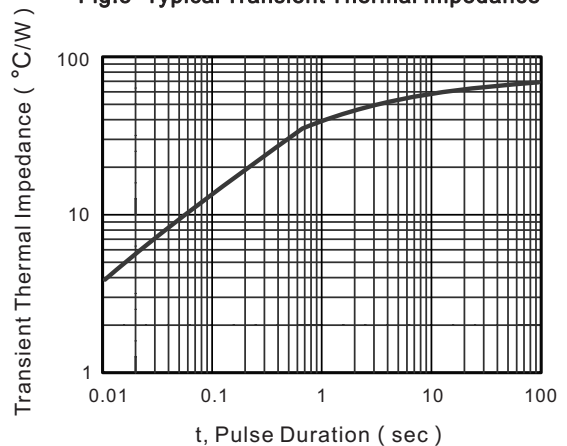

Fig.5- Typical Transient Thermal Impedance



The curve above is for reference only.



SS32 THRU SS3200

Reverse Voltage - 20 to 200 Volts Forward Current - 3.0 Ampere

Packing information

unit:mm

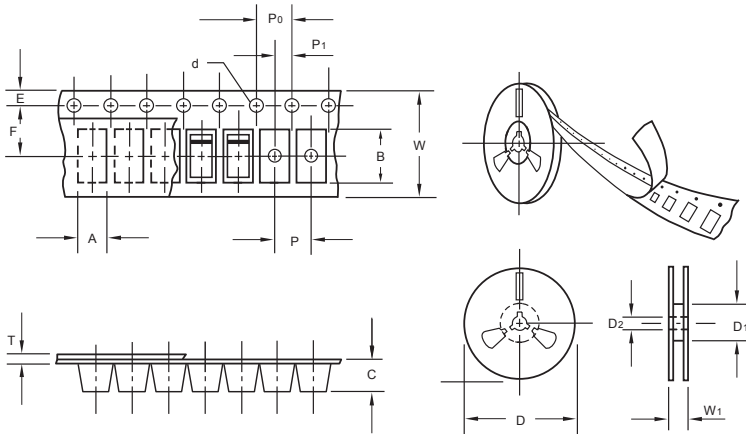

Item	Symbol	Tolerance	SMA
Carrier width	A	0.1	2.80
Carrier length	B	0.1	5.33
Carrier depth	C	0.1	2.36
Sprocket hole	d	0.05	1.50
13" Reel outside diameter	D	2.0	330.00
13" Reel inner diameter	D1	min	50.00
7" Reel outside diameter	D	2.0	178.00
7" Reel inner diameter	D1	min	62.00
Feed hole diameter	D2	0.5	13.00
Sprocket hole position	E	0.1	1.75
Punch hole position	F	0.1	5.50
Punch hole pitch	P	0.1	4.00
Sprocket hole pitch	P0	0.1	4.00
Embossment center	P1	0.1	2.00
Overall tape thickness	T	0.1	0.28
Tape width	W	0.3	12.00
Reel width	W1	1.0	18.00

Note: Devices are packed in accordance with EIA standard RS-481-A and specifications listed above.

Reel packing

PACKAGE	REEL SIZE	REEL (pcs)	COMPONENT SPACING (m/m)	BOX (pcs)	INNER BOX (m/m)	REEL DIA, (m/m)	CARTON SIZE (m/m)	CARTON (pcs)	APPROX. GROSS WEIGHT (kg)
SMA	7"	2,000	4.0	4,000	183*155*183	178	382*356*392	80,000	16.0
SMA	11"	5,000	4.0	10,000	290*290*38	330	310*310*360	80,000	11.0
SMA	13"	7,500	4.0	15,000	335*335*38	330	350*330*360	120,000	14.5

Suggested Pad Layout



Symbol	Unit (mm)	Unit (inch)
A	1.68	0.066
B	1.52	0.060
C	3.90	0.154
D	2.41	0.095
E	5.45	0.215

X-ON Electronics

Largest Supplier of Electrical and Electronic Components

Click to view similar products for [Schottky Diodes & Rectifiers](#) category:

Click to view products by [Microdiode Electronics](#) manufacturer:

Other Similar products are found below :

[MA4E2039](#) [MA4E2508M-1112](#) [MBR10100CT-BP](#) [MBR1545CT](#) [MMBD301M3T5G](#) [GS1JE-TP](#) [RB160M-50TR](#) [BAS 3010S-02LRH E6327](#)
[BAT 54-02LRH E6327](#) [NSR05F40QNXT5G](#) [NSVR05F40NXT5G](#) [NTE555](#) [JANS1N6640](#) [SB07-03C-TB-H](#) [SBS818-TL-E](#) [SK310-T](#)
[SK33A-TP](#) [SK34B-TP](#) [SS3003CH-TL-E](#) [PDS3100Q-7](#) [GA01SHT18](#) [CRS10I30A\(TE85L,QM](#) [MA4E2501L-1290](#) [MBRB30H30CT-1G](#)
[DMJ3940-000](#) [SB007-03C-TB-E](#) [SK32A-TP](#) [SK33B-TP](#) [SK35A-TP](#) [SK38B-LTP](#) [SK38B-TP](#) [NRVBM120LT1G](#) [NTE505](#)
[NTSB30U100CT-1G](#) [SS0503SH-TL-E](#) [VS-6CWQ10FNHM3](#) [CRG04\(T5L,TEMQ\)](#) [ACDBA1100LR-HF](#) [ACDBA1200-HF](#) [ACDBA2100-HF](#)
[ACDBA240-HF](#) [ACDBA3100-HF](#) [CDBQC0530L-HF](#) [ACDBA260LR-HF](#) [ACDBA1100-HF](#) [MA4E2502L-1246](#) [10BQ060-M3/5BT](#)
[NRVB130LSFT1G](#) [CRS08TE85LQM](#) [PMAD1108-LF](#)