

CUSTOMER: _____

DATE: _____

APPROVAL SPECIFICATION



PRODUCT NAME: SMD power inductor

YOUR PART NO.:

OUR PART NO.: MAPM0630F series

VERSION: V1.0

RECEPTION		
THE SPECIFICATION HAS BEEN ACCEPTED.		
COMPANY:		DATE:
CFMD	CHKD	RCVD

MANUFACTURING NAME

SHENZHEN MICROGATE TECHNOLOGY CO., LTD

Address: Yuxing road, Golf Street, Guanlan Town

Longhua District Shenzhen P.R.C

Postcode: 518110

TEL: 86-755-28085000

FAX: 86-755-28085605

CFMD.	CHKD.	DSGD.
Charles	Wang Yusheng	Liu Wei

CATALOG

	Component SPEC Version Record.....	3
1	Scope.....	4
2	Product Identification.....	4
3	Appearance, Dimensions and Material.....	4
4	Testing Conditions.....	5
5	Electrical Characteristics.....	5-6
6	Reliability.....	7-9
7	Recommended Soldering Condition.....	9
8	Packaging.....	10
9	Products Storage.....	11

Component SPEC Version Record

Rev.	Effective Date	Changed Contents	Change Reasons	Approved By
V1.0	2014.12.04	New released	/	Charles
V1.1	2018.03.08	Update the specifications	/	Charles

1. Scope

This specification applies to the MAPM0630F series of SMD Power inductors.

2. Product Identification

MAPM 0630F -1R5 M -LF
 ① ② ③ ④ ⑤

- ① Product Symbol
- ② Dimensions
- ③ Inductance Value (1R5:1.5uH 100: 10uH; 101:100uH)
- ④ Inductance Tolerance (K:10% ; M:20% ; N:30%)
- ⑤ Lead-Free

3. Appearance, Dimensions and Material

(1) Appearance and dimensions

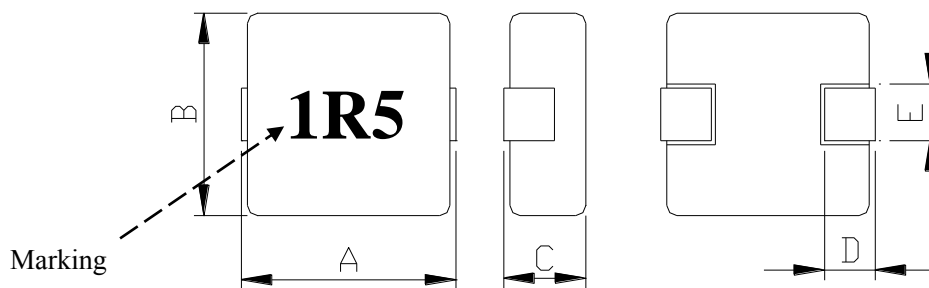

Recommend
Land Patter

Dimensions in mm				
A	B	C	D	E
7.8Max.	7.0Max.	3.0 Max.	1.5±0.5	3.0±0.3

(2) Recommend Land Pattern

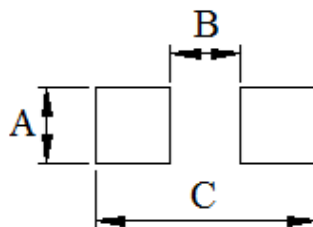

Dimensions in mm	
A	3.5
B	3.7
C	8.4

(3)Material List

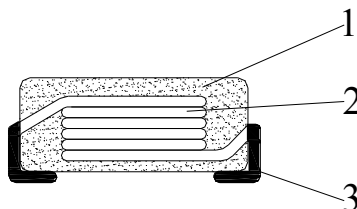

No.	Item	Material
1	Core	Alloy Material
2	Wire	Enameled Copper Wire
3	Terminal	Tin Covered Copper

SHENZHEN MICROGATE TECHNOLOGY CO., LTD.

Add** Yuxing road, Golf Street, Guanlan Town Longhua District Shenzhen P.R.C

Tel** +86-755-28085000

Fax** +86-755-28085605

Postcode** 518110

4. Testing Conditions

Unless otherwise specified, the standard conditions for measurement/test as:

Ambient Temperature : 5 to 35°C
 Relative Humidity: 25 to 85% RH
 Atmospheric Pressure: 86 to 106 kPa

If any doubt on the results, measurements/tests should be made within the following limits:

Ambient Temperature : 25±1°C
 Relative Humidity: 60 to 70% RH
 Atmospheric Pressure: 86 to 106 kPa

5. Electrical Characteristics And Test Instruments

Microgate Part No.	Inductance L0 (uH) 100KHz/1V	DCR (mΩ) Max	DCR (mΩ) typ.	Isat (A) Typ.	Irms (A) Typ.
MAPM0630F-R15M-LF	0.15±20%	2.7	2.3	40	23
MAPM0630F-R22M-LF	0.22±20%	3.5	3.0	32	20
MAPM0630F-R33M-LF	0.33±20%	4.0	3.5	28	19
MAPM0630F-R47M-LF	0.47±20%	4.5	3.2	25	18
MAPM0630F-R56M-LF	0.56±20%	5.5	4.7	24	16
MAPM0630F-R68M-LF	0.68±20%	5.8	5.5	23	15
MAPM0630F-R82M-LF	0.82±20%	8.0	6.5	20	13
MAPM0630F-1R0M-LF	1.0±20%	9.0	7.5	16	11
MAPM0630F-1R5M-LF	1.5±20%	16	13.8	14	9.0
MAPM0630F-1R8M-LF	1.8±20%	16	14	13	9.0
MAPM0630F-2R2M-LF	2.2±20%	20	16	12	8.0
MAPM0630F-3R3M-LF	3.3±20%	30	28	10	6.0
MAPM0630F-4R7M-LF	4.7±20%	40	38	9.0	5.5
MAPM0630F-5R6M-LF	5.6±20%	54	50	7.0	5.0
MAPM0630F-6R8M-LF	6.8±20%	60	51	6.0	4.5
MAPM0630F-8R2M-LF	8.2±20%	80	75	5.7	4.0
MAPM0630F-100M-LF	10±20%	95	78	5.5	3.5
MAPM0630F-150M-LF	15±20%	140	130	3.5	2.8
MAPM0630F-220M-LF	22±20%	167	150	3.0	2.5

Test instruments and remarks

- * L test by CHROMA 3302 meter or equivalent
- * DCR test by Tonghui TH2516B meter or equivalent
- * CHROMA 3302 and 1320 meter for IDC;
- * Isat: DC current (A) that will cause L0 to drop approximately 30%.
- * Irms: DC current (A) that will cause an temperature rise Δ T approximate to 40°C.
- * The rated current as listed is either the saturation current or the heating current depending on which value is lower.
- * Operating temperature: -55°C to +125°C
- * The part temperature (ambient + temp rise) should not exceed 125°C under worse case operating conditions. Circuit design, component placement, PCB trace size and thickness, airflow and other

SHENZHEN MICROGATE TECHNOLOGY CO., LTD.

Add** Yuxing road, Golf Street, Guanlan Town Longhua District Shenzhen P.R.C

Tel** +86-755-28085000 Fax** +86-755-28085605 Postcode** 518110

cooling provision all affect the part temperature. Part temperature should be verified in the end application.

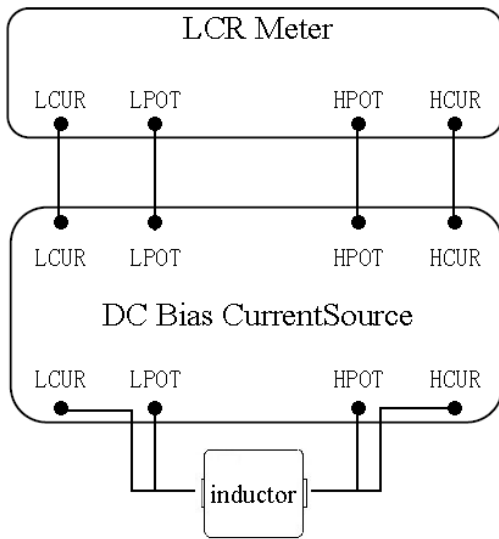

Isat test schematic diagram

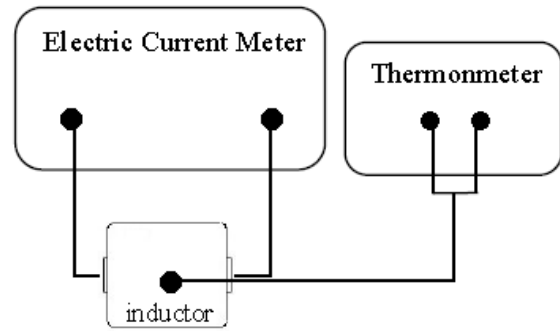

Irms test schematic diagram

6. Reliability

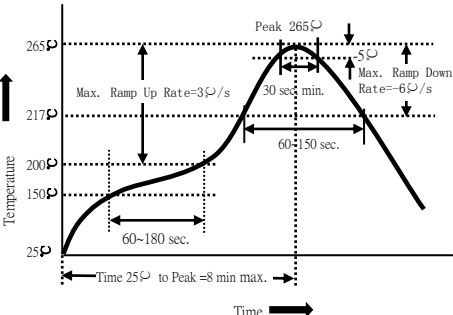
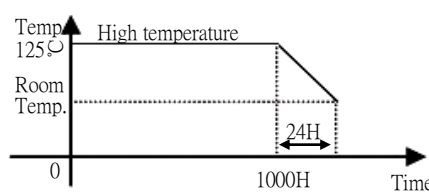
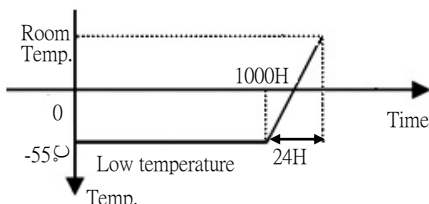
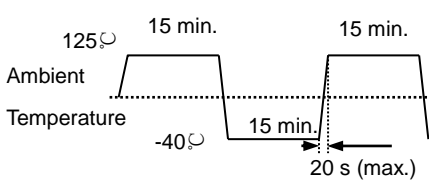
No.	Item	Requirements	Test Methods and Remarks	Reference	Sample Size
1	Solderability	(1) No case deformation or change in appearance. (2) Terminal area must have 95% min. solder coverage.	①Temperature: 255± 5℃, flux 5-10 s. ②Sample immersion tin furnace 5 ±0.5s. ③Immersed and in and out of speed: 25 ± 6mm/s.	AEC-Q200 (J-STD-002)	15
2	Resistance to Soldering Heat		①The peak temperature: 260+5/-0℃. ②Reflow: 3times. ③Temperature curve is as below: 	AEC-Q200 (MIL-STD-202 Method 210)	30
3	High Temperature Storage	(1) No case deformation or change in appearance.	①Temperature: 125±2℃. ②Time : 1000 hours. ③Measurement at 24±4 hours after test conclusion. 	AEC-Q200 (MIL-STD-202 Method 108)	77
4	Low Temperature Storage	(2) $ \Delta L/L \leq 10\%$	①Temperature: -55±2℃. ②Time : 1000 hours. ③Measurement at 24±4 hours after test conclusion. 	JESD22-A119	77
5	Thermal shock		①First -40℃ for 15 minutes, last 125℃ 15minutes as 1 cycle. Go through 300 cycles. ②Max transfer time is 20 second. ③Measurement at 24±4 hours after test conclusion. 	MIL-STD-202 Method 107	30

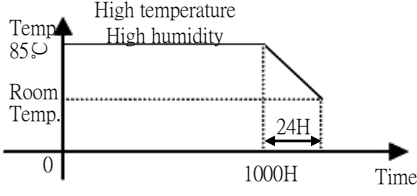
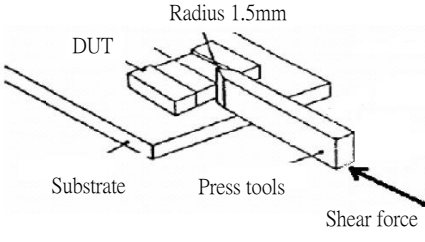
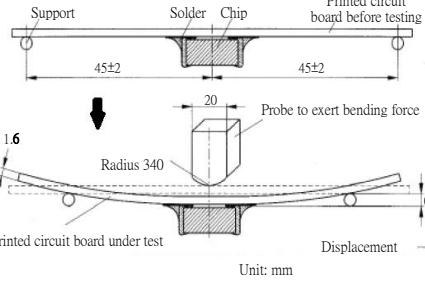
No.	Item	Requirements	Test Methods and Remarks	Reference	Sample Size
6	Humidity Resistance	(1) No case deformation or change in appearance. (2) $ \Delta L_0/L_0 \leq 10\%$	<p>①1000 hours, 85°C/85%RH. ②Unpowered. ③Measurement at 24±4 hours after test conclusion.</p> 	AEC-Q200 (MIL-STD-202 Method 103)	77
7	Terminal Strength	No case deformation or change in appearance.	<p>①The test samples shall be soldered to the board. ②17.64N, 60s,X,Y direct.</p> 	AEC-Q200 (AEC-Q200-06)	30
8	Board Flex	(1) No case deformation or change in appearance. (2) $ \Delta L_0/L_0 \leq 10\%$	<p>①Part mounted on a 100mm*40mm FR4 PCB board, which is 1.6±0.2 mm thick and as a Layer-thickness 35 μm ± 10 μm. ②Bending speed is 1mm/s. ③Keeping the P.C Board 2 mm minimum for 60 seconds.</p> 	AEC-Q200 (AEC-Q200-05)	30
9	Drop		<p>①Height: 1 m, Free fall, 10times. ②Direction: 1 Angle, 1side, 2surface.</p>	JESD22-B111	30
10	Vibration		<p>①Frequency range : 10~2000Hz. ②Amplitude: 1.5mm or 20 G. ③Sweep time and duration: 10~2000~10Hz for 20 minutes. ④Each four hours(12 times) in X,Y,Z direction, 12 hours in total.</p>	AEC-Q200 (MIL-STD-202 Method 204)	30

No.	Item	Requirements	Test Methods and Remarks	Reference	Sample Size
11	Loading at High Temperature	(1) No case deformation or change in appearance. (2) $ \Delta L_0/L_0 \leq 10\%$	① Temperature: $85 \pm 2^\circ\text{C}$. ② Time : 1000 hours. ③ Applied Current : Rated current. ④ Measurement at 24 ± 4 hours after test conclusion.	AEC-Q200 (MIL-PRF-27)	77

*All above experiments items need 3 Lot., sample size is as specified in the table above.

*Sample size standard is from AEC-Q200 : qualification sample size requirements.

7. Recommended Soldering Conditions

(1) Reflow soldering conditions

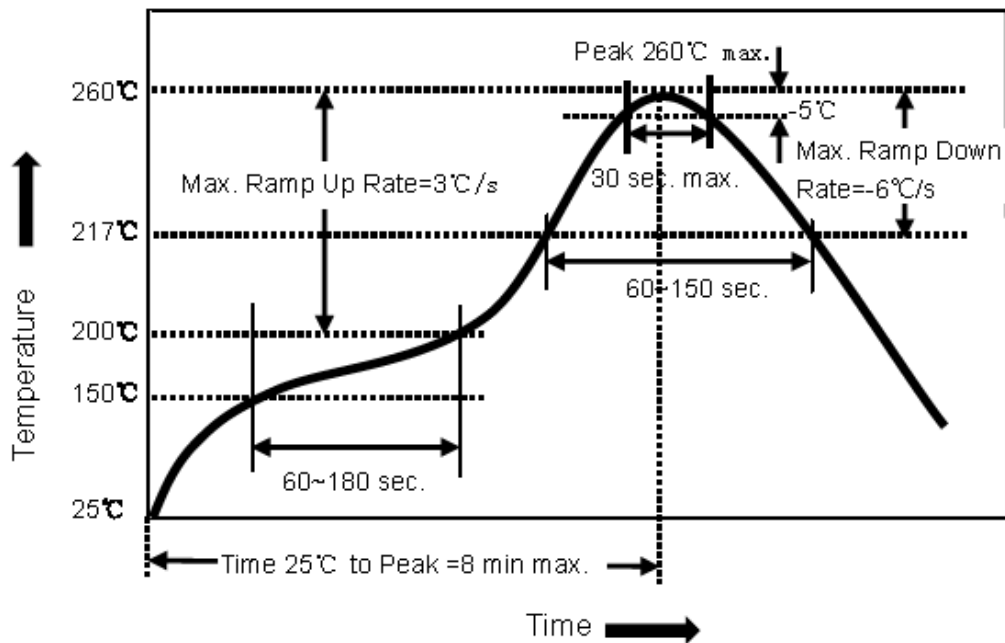

*Above reflow soldering curve is from J-STD-020D.

(2) Iron soldering

The following conditions must be strictly followed when using a soldering iron.

Pre-heating	150°C 1 minute
Tip temperature	350°C max
Soldering iron output	30w max
End of soldering iron	Φ 1mm max
Soldering time	3 seconds max

8.Packaging

(1) Dimension of tape (Unit: mm)

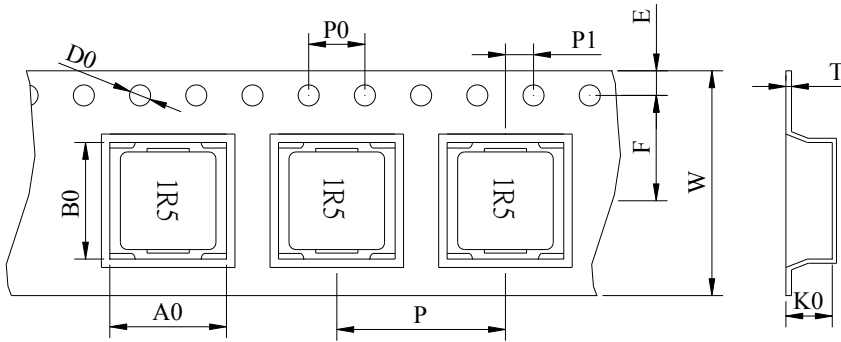

W	16.0±0.3
F	7.5±0.1
E	1.75±0.1
A0	7.15±0.2
B0	8.3±0.2
P	12.0±0.1
P0	4.0±0.1
P1	2.0±0.05
K0	3.3±0.2
T	0.40±0.1
φ D0	1.5+0.1/-0.0

(2) Dimension of reel (Unit: mm)

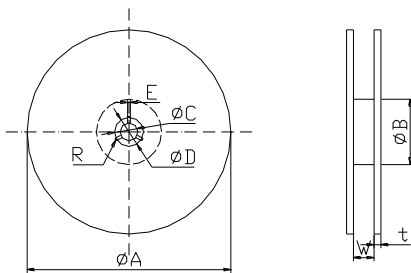

A	330
B	100
C	13.0±1.0
D	20.0±1.0
E	2.0±0.5
R	R1.0
W	17.0±1.0
t	2.0±0.2

(3) Taping figure and drawing direction

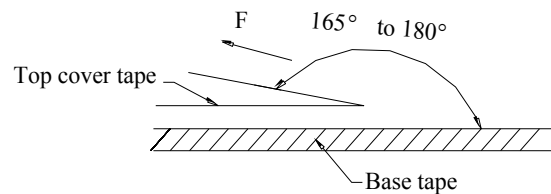

9. Products Storage

(1) Storage period

Products which inspected in MICROGATE over 12 months ago should be examined and used, which can be confirmed with inspection No. marked on the container. Solderability should be checked if this period is exceeded.

(2) Storage conditions

Products should be storage in the warehouse on the following conditions:

Temperature: -10 ~+ 35°C

Humidity : Less than 70% relative and humidity

No rapid change on temperature and humidity.

- (3) Don't keep products in corrosive gases such as sulfur, chlorine gas or acid, or it may cause oxidization of electrode, resulting in poor solderability.
- (4) Products should be storage on the palette for the prevention of the influence from humidity, dust and so on.
- (5) Products should be storage in the warehouse without heat shock, vibration, direct sunlight and so on.
- (6) Products should be storage under the airtight packaged condition.

X-ON Electronics

Largest Supplier of Electrical and Electronic Components

Click to view similar products for [Fixed Inductors](#) category:

Click to view products by [microgate](#) manufacturer:

Other Similar products are found below :

[MLZ1608M6R8WTD25](#) [MLZ1608N6R8LT000](#) [MLZ1608N3R3LTD25](#) [MLZ1608N3R3LT000](#) [MLZ1608N150LT000](#)

[MLZ1608M150WTD25](#) [MLZ1608M3R3WTD25](#) [MLZ1608M3R3WT000](#) [MLZ1608M150WT000](#) [MLZ1608A1R5WT000](#)

[MLZ1608N1R5LT000](#) [B82432C1333K000](#) [PCMB053T-1R0MS](#) [PCMB053T-1R5MS](#) [PCMB104T-1R5MS](#) [CR32NP-100KC](#) [CR32NP-](#)

[151KC](#) [CR32NP-180KC](#) [CR32NP-181KC](#) [CR32NP-1R5MC](#) [CR32NP-390KC](#) [CR32NP-3R9MC](#) [CR32NP-680KC](#) [CR32NP-820KC](#)

[CR32NP-8R2MC](#) [CR43NP-390KC](#) [CR43NP-560KC](#) [CR43NP-680KC](#) [CR54NP-181KC](#) [CR54NP-470LC](#) [CR54NP-820KC](#) [CR54NP-8R5MC](#)

[MGDQ4-00004-P](#) [MGDU1-00016-P](#) [MHL1ECTTP18NJ](#) [MHL1JCTTD12NJ](#) [PE-51506NL](#) [PE-53601NL](#) [PE-53630NL](#) [PE-53824SNLT](#) [PE-](#)

[62892NL](#) [PE-92100NL](#) [PG0434.801NLT](#) [PG0936.113NLT](#) [PM06-2N7](#) [PM06-39NJ](#) [HC2LP-R47-R](#) [HC2-R47-R](#) [HC3-2R2-R](#) [HC8-1R2-R](#)