

CUSTOMER: _____

DATE: _____

APPROVAL SPECIFICATION

PRODUCT NAME: SMD power inductor

CUSTOMER PART NO.:

OUR PART NO.: MPIT3015 Series

RECEPTION THE SPECIFICATION HAS BEEN ACCEPTED.		
COMPANY:		DATE:
CFMD	CHKD	RCVD

MANUFACTURING NAME

深圳市麦捷微电子科技股份有限公司

SHENZHEN MICROGATE TECHNOLOGY CO., LTD

Address: Yuxing road, Golf Street, Guanlan Town

Bao'an District Shenzhen P.R.C

Postcode :518110

TEL: 86-755-28085000

FAX: 86-755-28085605

CFMD.	CHKD.	DSGD.

目录 CATALOG

规格书版本控制 Component SPEC Version Record.....	2
1 适用范围 Scope.....	3
2 品名构成 Product Identification.....	3
3 形状、尺寸和材料 Appearance, Dimensions and Material.....	3
4 测试条件 Testing Conditions.....	4
5 电气特性 Electrical Characteristics.....	4
6 工作条件 Condition of work.....	5
7 信赖性试验 Reliable Performance.....	5-7
8 焊接条件 Recommended Soldering Conditions.....	8
9 包装 Packaging.....	9
10 产品外观检查标准 Visual inspection standard of product.....	10
11 存贮条件 Products Storage.....	10

深圳市麦捷微电子科技股份有限公司

地址：深圳市宝安区观澜镇高尔夫大道裕新路

电话(Tel): 0755-28085000

传真(Fax): 0755-28085605

邮编(Postcode): 518110

Component SPEC Version Record

Rev.	Effective Date	Changed Contents	Change Reasons	Approved By
01	Dec. 10.2010	New released	/	Charles

1. Scope

This specification applies to the MPIT3015 series of SMD power inductor.

2. Product Identification

$\frac{\text{MPIT}}{\text{①}}$ $\frac{3015}{\text{②}}$ - $\frac{6R8}{\text{③}}$ $\frac{M}{\text{④}}$ - $\frac{LF}{\text{⑤}}$

- ① Product Symbol (T type SMD power inductor)
- ② Product dimensions (3.0×3.0×1.5mm)
- ③ Inductance Value: (4R7: 4.7uH 100: 10uH; 101: 100uH)
- ④ Inductance Tolerance: (M: ±20% ; N: ±30%)
- ⑤ Lead free product.

3. Construction

3.1 Shape and dimensions

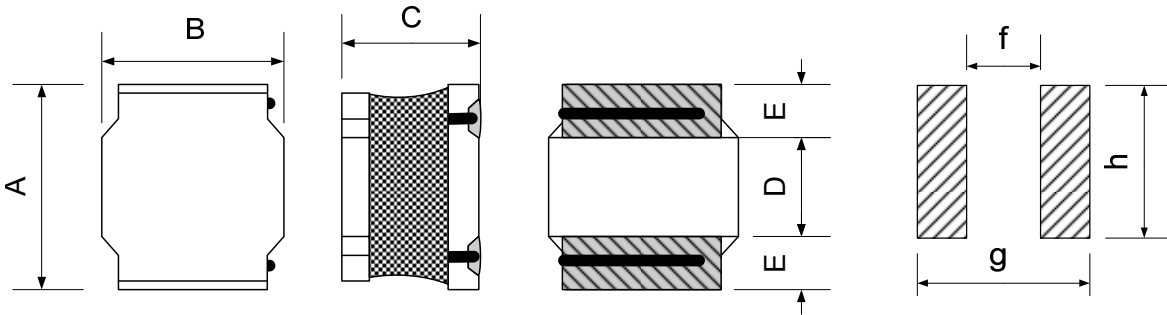

Recommended Land Pattern

Dimensions in mm								
Model	A	B	C	D	E	f	g	h
MPIT3015	3.00±0.20	3.00±0.20	1.50 Max.	1.50±0.20	0.75±0.20	1.50Typ.	3.10 Typ.	2.70 Typ.

3.2 Material List

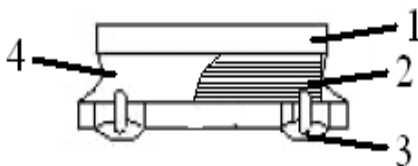

No.	Item	Material
1	Ferrite Core	Ni-Zn Ferrite
2	Wire	Enameled Copper Wire
3	Terminal Electrode	Ag/Ni/Sn/Cu
4	Magnetic Glue	Epoxy resin and magnetic powder

4. Testing Conditions

Unless otherwise specified

Temperature : Ordinary Temperature (5 to 35°C)
 Humidity : Ordinary Humidity (25 to 85% RH)
 Atmospheric Pressure : 86 to 106 kPa

In case of doubt

Temperature : 20±2°C
 Humidity : 60 to 75% RH
 Atmospheric Pressure : 86 to 106 kPa

5. Electrical Characteristics And Test Instruments

Microgate Part No.	Customer Part No.	Inductance (uH)	DCR (Ω) ±30%	Isat ¹ (A)	Irms ² (A)	SRF (MHz)
MPIT3015-1R0N-LF		1.0±30%	0.030	2.32	2.35	152
MPIT3015-1R2N-LF		1.2±30%	0.040	2.50	1.95	111
MPIT3015-1R5N-LF		1.5±30%	0.050	2.30	1.70	100
MPIT3015-1R8M-LF		1.8±20%	0.050	1.75	1.70	93
MPIT3015-2R2M-LF		2.2±20%	0.060	1.65	1.60	86
MPIT3015-2R7M-LF		2.7±20%	0.075	1.52	1.43	64
MPIT3015-3R3M-LF		3.3±20%	0.080	1.35	1.40	68
MPIT3015-3R6M-LF		3.6±20%	0.105	1.30	1.20	60
MPIT3015-4R3M-LF		4.3±20%	0.115	1.20	1.14	52
MPIT3015-4R7M-LF		4.7±20%	0.120	1.20	1.20	46
MPIT3015-5R1M-LF		5.1±20%	0.125	1.08	1.09	48
MPIT3015-6R8M-LF		6.8±20%	0.160	0.90	0.90	39
MPIT3015-100M-LF		10±20%	0.230	0.75	0.77	41
MPIT3015-120M-LF		12±20%	0.315	0.70	0.69	31
MPIT3015-150M-LF		15±20%	0.350	0.70	0.65	30
MPIT3015-180M-LF		18±20%	0.430	0.56	0.59	24
MPIT3015-220M-LF		22±20%	0.460	0.55	0.57	23
MPIT3015-270M-LF		27±20%	0.670	0.48	0.47	22
MPIT3015-330M-LF		33±20%	0.795	0.44	0.44	20
MPIT3015-390M-LF		39±20%	0.995	0.41	0.39	15
MPIT3015-430M-LF		43±20%	1.060	0.37	0.37	15
MPIT3015-470M-LF		47±20%	1.095	0.35	0.36	14
MPIT3015-560M-LF		56±20%	1.280	0.33	0.34	13
MPIT3015-620M-LF		62±20%	1.430	0.33	0.32	13
MPIT3015-680M-LF		68±20%	2.460	0.29	0.24	11

T-I characteristic curve

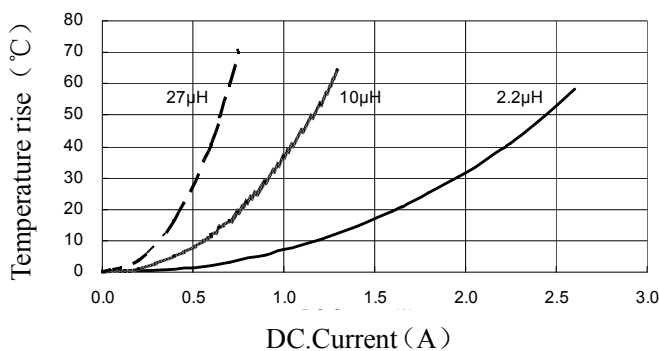

L-I characteristic curve

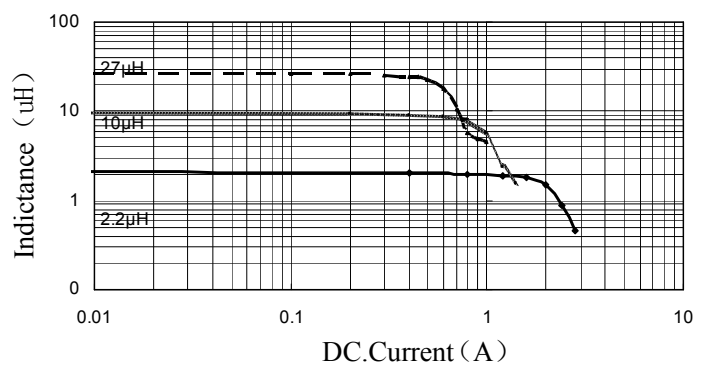

Test instruments and remarks

* CHROMA 3302 meter for L and DCR. /CHROMA 3302 and 1320 meter for IDC.

* L test condition: 100KHz&1V at 20°C ambient;

* Rated current: Isat or Irms, whichever is smaller:

¹: Isat: direct current at which the inductance drops approximate 30% from its value without current;

²: Irms: direct current when the temperature of the product rise ($\Delta T=40^{\circ}\text{C}$) from 20°C ambient.

6. Condition of work

1. The part normal work be allowed ambient temperature: $-25^{\circ}\text{C} \sim +85^{\circ}\text{C}$.
2. The part must be allowed high temperature: $+125^{\circ}\text{C}$.
3. The part normal work be allowed temperature dependent: 40°C
4. Ambient temperature of the part is allowed storage temperature: $-25^{\circ}\text{C} \sim +85^{\circ}\text{C}$.
5. Storage life: half a year
6. The part be allowed work ambient frequency: $0.1\text{MHz} \sim 1\text{MHz}$

7. Reliability and Test Condition

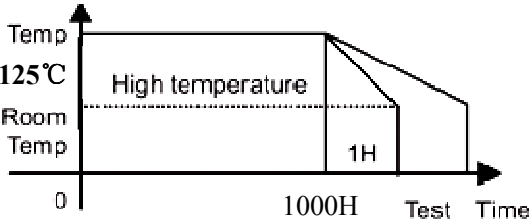
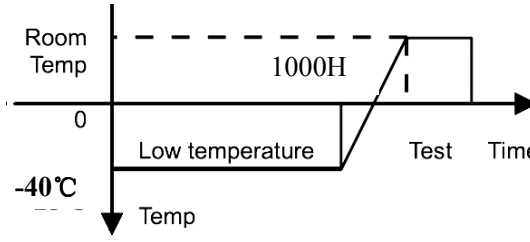
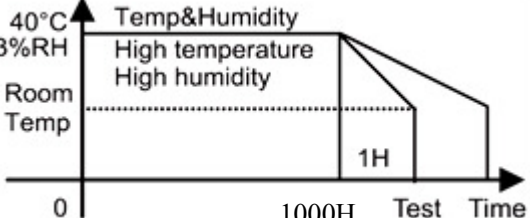
Item	Required Characteristics	Test Method/Condition
High temperature resistance		<p>Temperature: $125\pm 2^{\circ}\text{C}$ Time : 1000 hours Tested not less than 1 hours, nor more than 2 hours at room temperature.</p> 
Low temperature resistance	<ol style="list-style-type: none"> 1. No case deformation or change in appearance. 2. $\Delta L /L \leq 10\%$ 	<p>Temperature : $-40\pm 2^{\circ}\text{C}$ Time : 1000 hours Tested not less than 1 hour, nor more than 2 hours at room temperature.</p> 
Humidity test		<ol style="list-style-type: none"> 1. Exposure : Temperature:$60\pm 2^{\circ}\text{C}$, Humidity : $93\pm 3\%$ RH Time : 1000 hours. 2. Tested while the specimens are still in the chamber. 3. Tested not less than 1 hour, nor more than 2 hours at room temperature. 

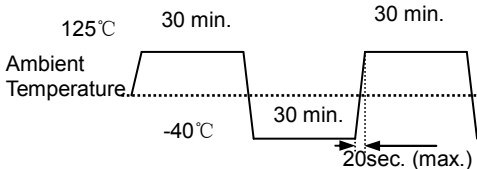
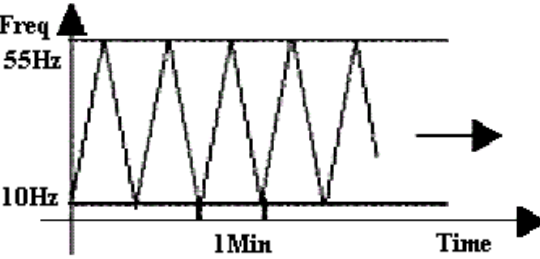
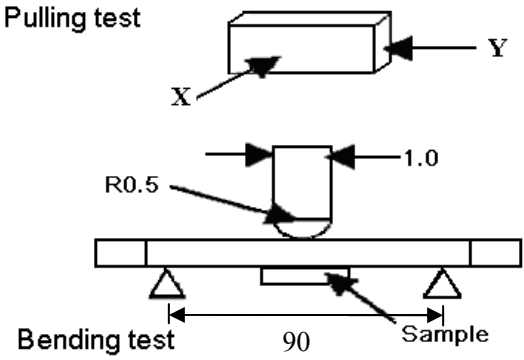
Item	Required Characteristics	Test Method/Condition
Thermal shock test	1. No case deformation or change in appearance. 2. $ \Delta L /L \leq 10\%$	First -40°C for T time, last 125°C T time as 1 cycle. Go through 100 cycles. 
Solderability test	Terminal area must have 90% min. solder coverage.	Dip pads in flux then dip in solder pot at $245 \pm 5^\circ\text{C}$ for <5 second. Solder: lead free Flux: rosin flux.
Heat endurance of reflow soldering	1. No case deformation or change in appearance. 2. $ \Delta L /L \leq 10\%$	Refer to the next page reflow curve Go through 3 times. The peak temperature: $260 + 5 / - 0^\circ\text{C}$
Vibration test		Apply frequency 10~55Hz. 1.5mm amplitude in each of perpendicular direction for 2 hours in each 3 mutually perpendicular directions.(total 6 hours) 
Drop test		Packaged & drop down from 1m with $981\text{m/s}^2(100\text{G})$ attitude in 1 angle 1 ridges & 2surfaces orientations.
Terminal strength push test	Pulling test: Define: Solder the products on testing PCB using eutectic solder. Then apply a force in the direction of the arrow. 10N force. Keep time $\geq 5\text{s}$ Bending test: Soldering the products on PCB, after the pulling test and bending test, terminal should not pull off.	Bend the testing PCB at middle point, the deflection shall be 2mm. Pressurizing Speed: 0.5mm/sec, Keep time: $30 \pm 1\text{s}$, 

Item	Required Characteristics	Test Method/Condition
Resistance to solvent test	No case deformation or change in appearance, or obliteration of marking	To dip parts into IPA solvent for 50.5Min, then drying them at room temp for 5Min., at last, to brushing marking 10 times.
Loading Under Humidity Heat	1. No case deformation or change in appearance. 2. $ \Delta L /L \leq 10\%$	1. Exposure : Temperature: $60 \pm 2^\circ\text{C}$, Humidity : $93 \pm 3\%$ RH Time : 1000 hours. Apply rated current 2. Tested while the specimens are still in the chamber. 3. Tested not less than 1 hour, nor more than 2 hours at room temperature.
Loading at High Temperature	1. No case deformation or change in appearance. 2. $ \Delta L /L \leq 10\%$	1. Temperature: $85 \pm 2^\circ\text{C}$ 2. Time : 1000 hours 3. Apply rated current 4. Tested not less than 1 hours, nor more than 2 hours at room temperature.

8. Recommended Soldering Conditions

Product can be applied to flow and reflow soldering.

(1) Flux, Solder

① Use rosin-based flux. Don't use highly acidic flux with halide content exceeding 0.2wt% (chlorine conversion value).

② Use Sn solder.

(2) Flow soldering conditions

① Pre-heating should be in such a way that the temperature difference between solder and product surface is limited to 150°C max. Cooling into solvent after soldering also should be in such a way that temperature difference is limited to 100°C max. Unwrought pre-heating may cause cracks on the product, resulting in the deterioration of products quality.

② Standard soldering profile.

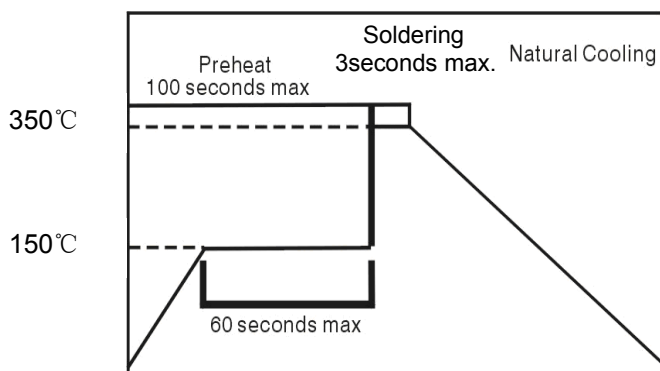

Pre-heating	150°C, 1 minute min
Peak	350°C, 3 seconds max

(3)Reflow soldering conditions

Reflow curve :

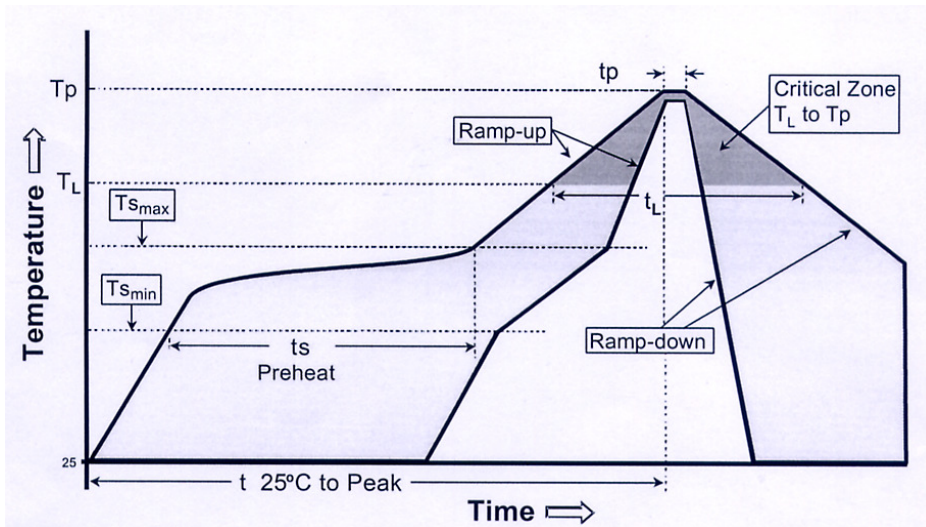

Profile Feature		Lead-Free Assembly
Average Ramp-Up Rate (Ts max. to Tp)		3°C /second max.
Preheat	<ul style="list-style-type: none"> - Temperature Min (Ts min.) - Temperature Max (Ts max.) - Time (ts min to ts max.) 	150 °C 200 °C 60-180 seconds
Time maintained above	<ul style="list-style-type: none"> - Temperature (TL) - Time (tL) 	217 °C 60-150 seconds
Peak/Classification Temperature (Tp)		260 °C
Peak/Classification Time (Tp)		3-4 seconds
Time within 5 °C of actual Peak Temperature (tp)		20-40 seconds
Ramp-Down Rate		6°C/second max.
Time 25 °C to Peak Temperature		8 minutes max.

Note 1: All temperatures refer to topside of the package, measured on the package body surface.

(4) The method on Re-work with using the iron:

The following conditions must be strictly followed when using a soldering iron

Pre-heating	150°C, 1 minute
Tip temperature	350°C max
Soldering iron output	80w max
End of soldering iron	φ1mm max
Soldering time	3 seconds max

Product once removes from the circuit board may not be used again.

9. Package Information

9.1 Dimension of tape (Unit: mm)

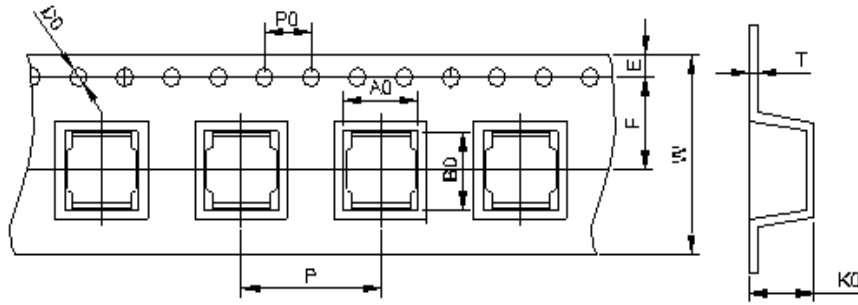

W	A0	B0	K0	E	F	P	P0	D0	T
8.0±0.3	3.3±0.1	3.3±0.1	1.9±0.1	1.75±0.1	3.5±0.05	4.0±0.1	4.0±0.1	1.5+0.1/-0.0	0.25±0.05

9.2 Dimension of reel (Unit: mm)

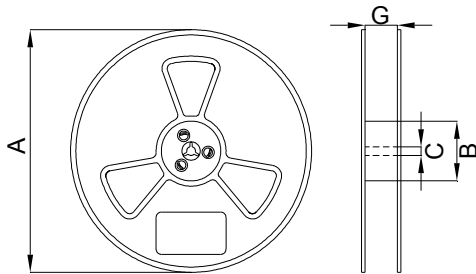

Symbol	Dimension
A	178±2
B	58±2
C	13.5±0.2
G	9.0±1.5

9.3 Taping figure and drawing direction

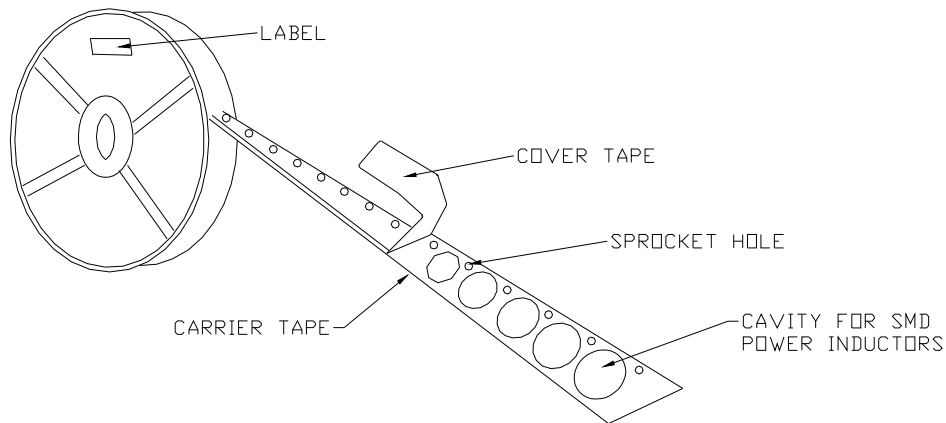

9.4 Packaging quantities:2000PCS/Reel.

9.5 Peeling strength of cover tape:

The peel force of top cover tape shall be between 0.1N to 1.0 N

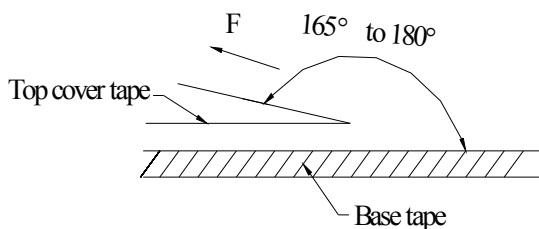

Room Temp. (°C)	Room Humidity (%)	Room aim (hpa)	Peel Speed Mm/min
5-35	45-85	860-1060	300

10. Visual inspection standard of product

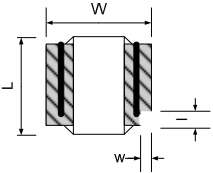
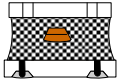
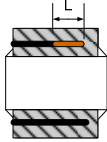
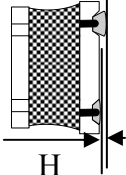
No.	Defect Item	Graphic	Rejection identification	Acceptance
1	Core defect		$l > L/6$ or $w > W/6$, NG.	AQL=0.65
2	Missing resin		The area of missing resin more than single face, NG	AQL=0.65
3	Cold solder		L more than 1 mm, NG.	AQL=0.65
4	Solder uneven		$H > 0.1\text{mm}$. NG.	AQL=0.65

11. Products Storage

(1) Storage period

Products which inspected in MICROGATE over 6 months ago should be examined and used, which can be confirmed with inspection No. marked on the container. Solderability should be checked if this period is exceeded.

(2) Storage conditions

Products should be storage in the warehouse on the following conditions:

Temperature: $-10 \sim +40^{\circ}\text{C}$

Humidity : Less than 80% relative and humidity

No rapid change on temperature and humidity

- (3) Don't keep products in corrosive gases such as sulfur, chlorine gas or acid, or it may cause oxidization of electrode, resulting in poor solderability.
- (4) Products should be storage on the palette for the prevention of the influence from humidity, dust and so on.
- (5) Products should be storage in the warehouse without heat shock, vibration, direct sunlight and so on.
- (6) Products should be storage under the airtight packaged condition.

X-ON Electronics

Largest Supplier of Electrical and Electronic Components

Click to view similar products for [Fixed Inductors](#) category:

Click to view products by [microgate](#) manufacturer:

Other Similar products are found below :

[MLZ1608M6R8WTD25](#) [MLZ1608N6R8LT000](#) [MLZ1608N3R3LTD25](#) [MLZ1608N3R3LT000](#) [MLZ1608N150LT000](#)

[MLZ1608M150WTD25](#) [MLZ1608M3R3WTD25](#) [MLZ1608M3R3WT000](#) [MLZ1608M150WT000](#) [MLZ1608A1R5WT000](#)

[MLZ1608N1R5LT000](#) [B82432C1333K000](#) [PCMB053T-1R0MS](#) [PCMB053T-1R5MS](#) [PCMB104T-1R5MS](#) [CR32NP-100KC](#) [CR32NP-](#)

[151KC](#) [CR32NP-180KC](#) [CR32NP-181KC](#) [CR32NP-1R5MC](#) [CR32NP-390KC](#) [CR32NP-3R9MC](#) [CR32NP-680KC](#) [CR32NP-820KC](#)

[CR32NP-8R2MC](#) [CR43NP-390KC](#) [CR43NP-560KC](#) [CR43NP-680KC](#) [CR54NP-181KC](#) [CR54NP-470LC](#) [CR54NP-820KC](#) [CR54NP-8R5MC](#)

[MGDQ4-00004-P](#) [MGDU1-00016-P](#) [MHL1ECTTP18NJ](#) [MHL1JCTTD12NJ](#) [PE-51506NL](#) [PE-53601NL](#) [PE-53630NL](#) [PE-53824SNLT](#) [PE-](#)

[62892NL](#) [PE-92100NL](#) [PG0434.801NLT](#) [PG0936.113NLT](#) [PM06-2N7](#) [PM06-39NJ](#) [HC2LP-R47-R](#) [HC2-R47-R](#) [HC3-2R2-R](#) [HC8-1R2-R](#)