

1. Scope

This specification applies to the MPIT series of SMD power inductors.

2. Product Identification

MPIT 5040 – 100 M - LF
 ① ② ③ ④ ⑤

- ① Series name
- ② Product dimensions
- ③ Inductance Value: (6R3:6.3uH 100: 10uH; 101:100uH)
- ④ Inductance Tolerance: (K:10% ; M:20% ; N:30%)
- ⑤ Lead free products

3. Construction

3.1 Shape and dimensions

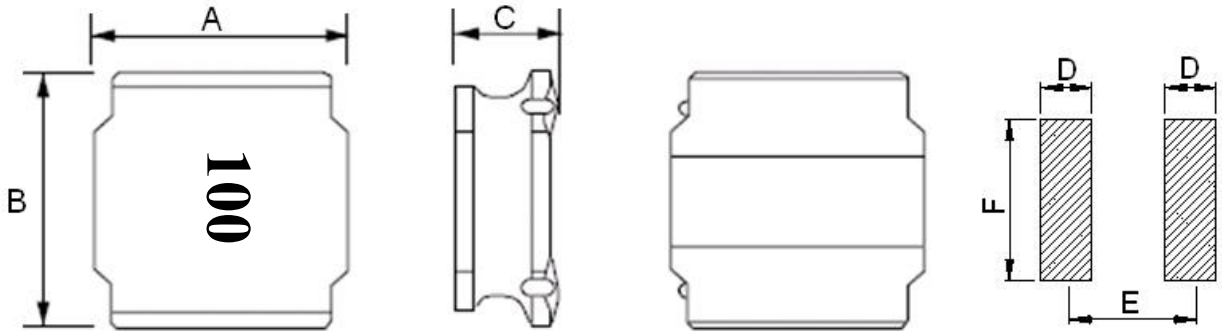

Dimensions in mm						
Model	A	B	C	D	E	F
MPIT5040	5.0±0.3	5.0±0.3	4.0 Max.	1.4 ref.	3.7 ref.	4.2 ref.

3.2 Material List

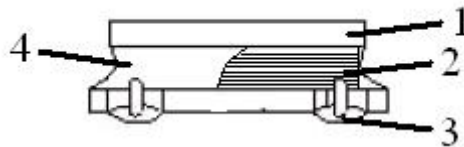

No.	Item	Material
1	DR Core	Ferrite
2	Wire	Enameled Copper Wire
3	Solder	Sn99.7-Cu0.3
4	Epoxy	Epoxy Adhesive

4. Testing Conditions

Unless otherwise specified

Temperature : Ordinary Temperature (5 to 35°C)

Humidity : Ordinary Humidity (25 to 85% RH)

Atmospheric Pressure : 86 to 106 kPa

In case of doubt

Temperature : 20±2°C

Humidity : 60 to 75% RH

Atmospheric Pressure : 86 to 106 kPa

5. Electrical Characteristics And Test Instruments

Operating temperature:-40~85°C

Storage temperature and Humidity Range: -40~125°C & 30% to 70%

Part No.	Customer Part No.	Inductance (uH)	DCR (mΩ)max	Isat (A) max	Irms (A) max
MPIT5040-1R0N-LF		1.0±30%	13	7.35	4.9
MPIT5040-1R5N-LF		1.5±30%	15	6.30	4.2
MPIT5040-2R2N-LF		2.2±30%	19	4.90	3.7
MPIT5040-3R3N-LF		3.3±30%	24	3.95	3.4
MPIT5040-4R7M-LF		4.7±20%	30	3.50	3.0
MPIT5040-5R6M-LF		5.6±20%	33	3.2	2.5
MPIT5040-6R8M-LF		6.8±20%	49	3.0	2.3
MPIT5040-100M-LF		10±20%	64	2.85	2.1
MPIT5040-150M-LF		15±20%	86	2.5	2.0
MPIT5040-220M-LF		22±20%	129	1.8	1.4
MPIT5040-330M-LF		33±20%	188	1.5	1.2
MPIT5040-470M-LF		47±20%	270	1.25	1.0
MPIT5040-680M-LF		68±20%	400	0.96	0.77
MPIT5040-101M-LF		100±20%	560	0.82	0.66
MPIT5040-221M-LF		220±20%	1030	0.55	0.45

1. L,DC: LCR Meter HP4263A, CH3302+1310 ,or equivalent
2. RDC:CH3302,or equivalent.
3. Isat: DC current (A) that will cause L0 to drop 30% Max.
4. Irms: DC current (A) that will cause an approximate ΔT : 40°C .Max
5. Operating temperature range from -25°C to 85°C

6. Reliability and Test Condition

Item	Specifications	Test Method/Condition
Operating temperature range	-25°C ~ +85°C	Including temperature rise due to self-generated heat
Terminal strength-pull test	Terminal shall not be loosened or ruptured	A 5N. load shall be applied to both terminals in the axis direction for 60 sec.
Solderability test	The terminal shall be at least 90% covered with solder.	After fluxing, Inductor shall be dipped in a melted solder bath at 230±5 °C for 5 seconds.
Resistance to solvent test	There shall be no case deformation change in appearance obliteration of marking.	MIL-STD-105E II
Vibration test (low frequency)	1. Inductors shall be no evidence of electrical and mechanical damage. 2. Inductance shall not change more than=5%. 3. Q shall not change more than=20%	1. Amplitude: 1.5mm. 2. Frequency: 10~55~10Hz/min. 3. Direction: X.Y.Z. 4. Duration: 2 hrs/X.Y.Z.
Shock test		Inductors shall be dropped 10 from a height of 1m onto 3cm wooden board.
Resistance to soldering heat		Temp: 260±5°C, Time: 10±1sec
High temperature load life test	There shall be no evidence of Short or open circuiting.	1. temp: 85±2°C. 2. time: 1000±12 hours. 3. load: allowed DC current.
Humidity load life		1. temp: 40±2°C. 2. R.H: 90-95%. 3. time: 1000±12 hours. 4. load: allowed DC current.

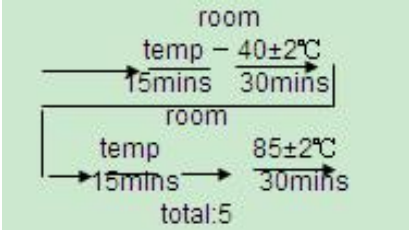
Item	Required Characteristics	Test Method/Condition
Temperature characteristic		-25°C ~ +85°C
Humidity test		1. Temp:40±2°C. 2. R.H:90-95%. 3. Time:96±2 hours.
Cold test	1. Inductors shall be no evidence of electrical and mechanical damage 2. Inductance shall not change more than±5%.	1. Temp:-40±2°C. 2. Time:96±2 hours.
Thermal shock test	3. Q shall not change more than ±30%.	 <p>The diagram illustrates a thermal shock test cycle. It starts with a 15-minute dwell at room temperature. This is followed by a 30-minute dwell at -40±2°C. The cycle then returns to room temperature for another 15-minute dwell. This sequence is repeated, with a total of 5 cycles. The final dwell is at 85±2°C for 30 minutes.</p>
Dry heat test		1. temp:85±2°C 2. time: 96±2 hours

7. Recommended Soldering Conditions

Product can be applied to flow and reflow soldering.

(1) Flux, Solder

① Use rosin-based flux. Don't use highly acidic flux with halide content exceeding 0.2wt% (chlorine conversion value).

② Use Sn solder.

(2) Flow soldering conditions

① Pre-heating should be in such a way that the temperature difference between solder and product surface is limited to 150°C max. Cooling into solvent after soldering also should be in such a way that temperature difference is limited to 100°C max. Unwrought pre-heating may cause cracks on the product, resulting in the deterioration of products quality.

② Standard soldering profile.

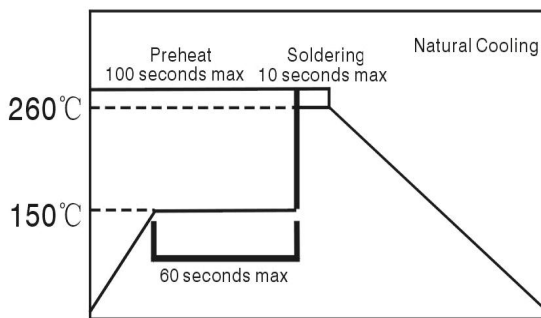

Pre-heating	150°C, 1 minute min
Peak	260°C, 10 seconds max

(3) Reflow soldering conditions

Profile Feature		Lead-Free Assembly
Average Ramp-Up Rate (Ts max. to Tp)		3°C /second max.
Preheat	- Temperature Min (Ts min.)	150 °C
	- Temperature Max (Ts max.)	200 °C
	- Time (ts min to ts max.)	60-180 seconds
Time maintained above	- Temperature (TL)	217 °C
	- Time (tL)	60-150 seconds
Peak/Classification Temperature (Tp)		260 °C
Peak/Classification Time (Tp)		3-4 seconds
Time within 5 °C of actual Peak Temperature (tp)		20-40 seconds
Ramp-Down Rate		6°C/second max.
Time 25 °C to Peak Temperature		8 minutes max.

Note 1: All temperatures refer to topside of the package, measured on the package body surface.

Reflow curve

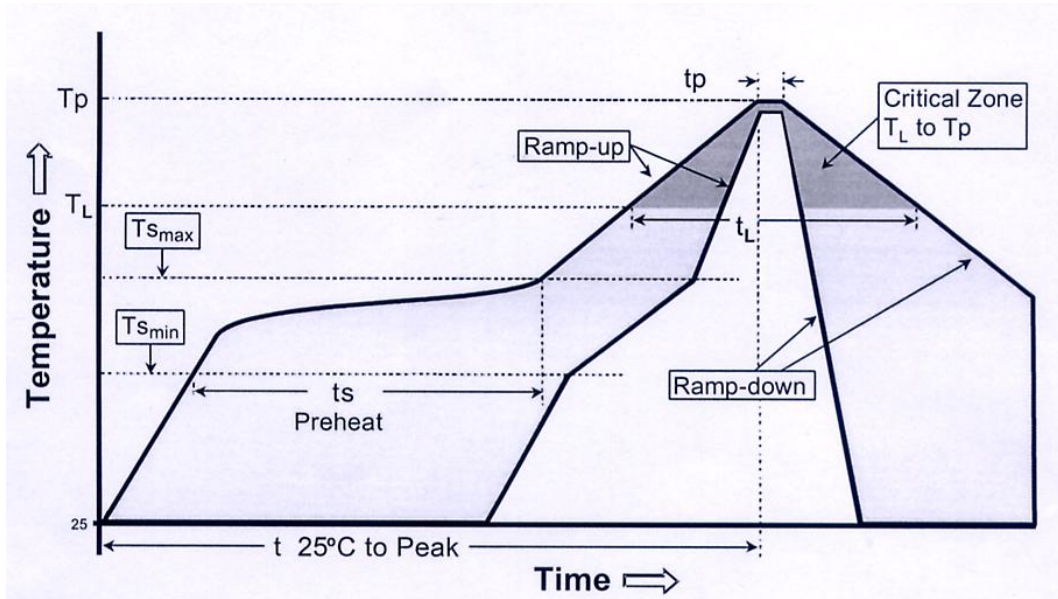

(4) The method on Re-work with using the iron:

The following conditions must be strictly followed when using a soldering iron

Pre-heating	150°C, 1 minute
Tip temperature	280°C max
Soldering iron output	20w max
End of soldering iron	ϕ 1mm max
Soldering time	3 seconds max

8. Cleaning Conditions

Products shall be cleaned on the following conditions.

- (1) Cleaning temperature shall be limited to 60°C max.(40°C max for fluoride and alcohol type cleaner.)
- (2) Ultrasonic cleaning shall comply with the following conditions with avoiding the resonance phenomenon at the mounted products and P.C.B.

Power : 20W/t max
 Frequency: below 40 kHz
 Time : 5 minutes max

(3) Cleaner

- a) Alternative cleaner
Isopropyl alcohol (IPA) HCFC-225
- b) Aqueous agent
Surface Active Agent Type (CLEANTHROUGH 750H)
Hydrocarbon Type (TECHNOCLEANER 335)
Higher Alcohol Type (PINE ALPHA ST-100S)
Alkali Saponification Type (*AQUACLEANER 240)

(4) There shall be no residual flux and residual cleaner after cleaning. In the case of using aqueous agent, products shall be dried completely after rinse with de-ionized water in order to remove the cleaner.

(5) Other cleaning

Please contact us.

9. Package Information (Unit: mm)

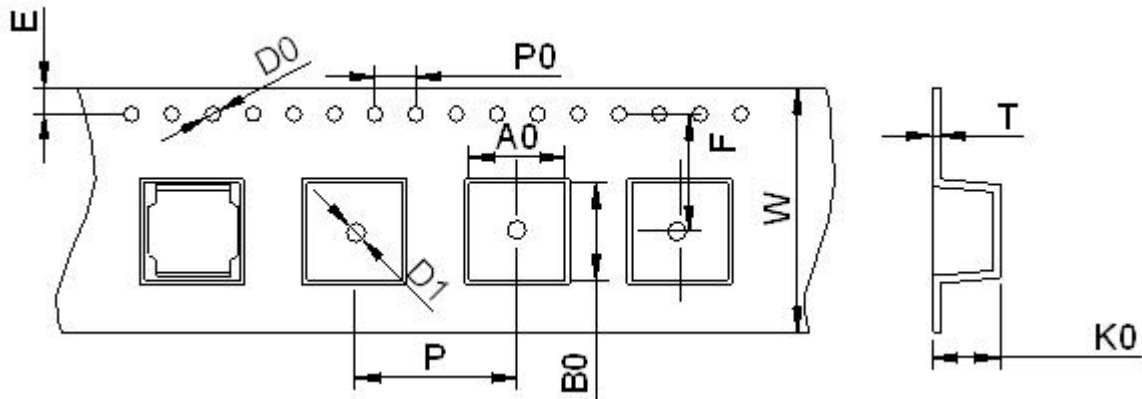

16.0±0.3	6.4±0.10	6.4±0.10	4.80±0.10	/	1.75±0.10	7.5±0.10	12.0±0.10	4.00±0.10	1.50±0.10	1.50±0.30	0.35±0.05
W	A0	B0	K0	K1	E	F	P	P0	D0	D1	T

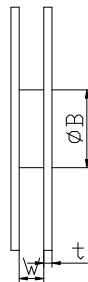
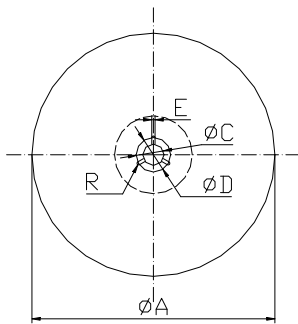

A	330±2.0
B	100±2.0
C	13.5±0.5
D	21±0.5
E	2.2
R	R1.0
W	16.5
t	2.5

Packing quantity: 2000pcs/reel

9.1 Peeling strength of cover tape:

The force tearing off cover tape is 30 to60 grams in the arrow direction under the following conditions.

Room Temp. (°C)	Room Humidity (%)	Room aim (hpa)	Peel Speed Mm/min
5-35	45-85	860-1060	300

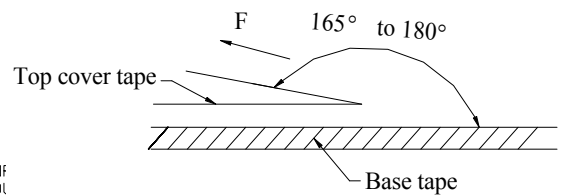
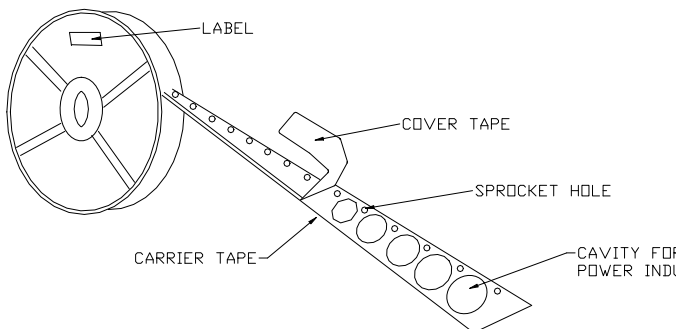

10. Products Storage

(1) Storage period

Products which inspected in MICROGATE over 6 months ago should be examined and used, which can be confirmed with inspection No. marked on the container. Solderability should be checked if this period is exceeded.

(2) Storage conditions

Products should be storage in the warehouse on the following conditions:

Temperature: -10 ~+ 40°C

Humidity : Less than 80% relative and humidity

No rapid change on temperature and humidity

- (3) Don't keep products in corrosive gases such as sulfur, chlorine gas or acid, or it may cause oxidization of electrode, resulting in poor solderability.
- (4) Products should be storage on the palette for the prevention of the influence from humidity, dust and so on.
- (5) Products should be storage in the warehouse without heat shock, vibration, direct sunlight and so on.
- (6) Products should be storage under the airtight packaged condition.

X-ON Electronics

Largest Supplier of Electrical and Electronic Components

Click to view similar products for [Fixed Inductors](#) category:

Click to view products by [microgate](#) manufacturer:

Other Similar products are found below :

[MLZ1608M6R8WTD25](#) [MLZ1608N6R8LT000](#) [MLZ1608N3R3LTD25](#) [MLZ1608N3R3LT000](#) [MLZ1608N150LT000](#)

[MLZ1608M150WTD25](#) [MLZ1608M3R3WTD25](#) [MLZ1608M3R3WT000](#) [MLZ1608M150WT000](#) [MLZ1608A1R5WT000](#)

[MLZ1608N1R5LT000](#) [B82432C1333K000](#) [PCMB053T-1R0MS](#) [PCMB053T-1R5MS](#) [PCMB104T-1R5MS](#) [CR32NP-100KC](#) [CR32NP-](#)

[151KC](#) [CR32NP-180KC](#) [CR32NP-181KC](#) [CR32NP-1R5MC](#) [CR32NP-390KC](#) [CR32NP-3R9MC](#) [CR32NP-680KC](#) [CR32NP-820KC](#)

[CR32NP-8R2MC](#) [CR43NP-390KC](#) [CR43NP-560KC](#) [CR43NP-680KC](#) [CR54NP-181KC](#) [CR54NP-470LC](#) [CR54NP-820KC](#) [CR54NP-8R5MC](#)

[MGDQ4-00004-P](#) [MGDU1-00016-P](#) [MHL1ECTTP18NJ](#) [MHL1JCTTD12NJ](#) [PE-51506NL](#) [PE-53601NL](#) [PE-53630NL](#) [PE-53824SNLT](#) [PE-](#)

[62892NL](#) [PE-92100NL](#) [PG0434.801NLT](#) [PG0936.113NLT](#) [PM06-2N7](#) [PM06-39NJ](#) [HC2LP-R47-R](#) [HC2-R47-R](#) [HC3-2R2-R](#) [HC8-1R2-R](#)