

CUSTOMER:

客户名称: _____

DATE:

日期: _____

APPROVAL SPECIFICATION 规格承认书

产品名称 PRODUCT NAME: 贴片功率电感 SMD power inductor

客户料号 CUSTOMER PART NO.: _____

麦捷料号 OUR PART NO.: MPIT5040 系列 MPIT5040 series

版本号 VERSION.: Rev1.0

RECEPTION 接受 THE SPECIFICATION HAS BEEN ACCEPTED. 该纳入仕様书已被我司接受 <div style="display: flex; justify-content: space-between;"> COMPANY 公司: DATE 日期: </div>		
CFMD 批准	CHKD 审核	RCVD 接收

制造公司 MANUFACTURING NAME

深圳市麦捷微电子科技股份有限公司

SHENZHEN MICROGATE TECHNOLOGY CO., LTD

地址: 深圳市龙华区观澜高尔夫大道裕新路

Address: Yuxing road, Golf Street, Guanlan Town

Longhua District Shenzhen P.R.C

邮编:518110 Postcode :518110

电话: 86-755-28085000 TEL: 86-755-28085000

传真: 86-755-28085605 FAX: 86-755-28085605

CFMD. 批准	CHKD. 审核	DSGD. 担当
charles	王玉生	刘维

目录 CATALOG

	规格书版本控制 Component SPEC Version Record.....	2
1	适用范围 Scope.....	3
2	品名构成 Product Identification.....	3
3	形状、尺寸和材料 Appearance, Dimensions and Material.....	3
4	测试条件 Testing Conditions.....	4
5	电气特性 Electrical Characteristics.....	4
6	工作条件 Condition of work.....	4
7	信赖性试验 Reliable Performance.....	5-6
8	焊接条件 Recommended Soldering Conditions.....	7-8
9	包装 Packaging.....	9
10	产品外观检验标准 Visual inspection standard of product.....	10
11	存储 Storage.....	11

深圳市麦捷微电子科技股份有限公司

地址：深圳市宝安区观澜镇高尔夫大道裕新路

电话(Tel): 0755-28085000

传真(Fax): 0755-28085605

邮编(Postcode): 518110

1. 适用范围 Scope

本规格书适用于 MPIT5040 系列贴片功率电感

This specification applies to the MPIT5040 series of SMD power inductors.

2. 品名构成 Product Identification

$\frac{\text{MPIT}}{\text{①}} \quad \frac{5040}{\text{②}} - \frac{100}{\text{③}} \quad \frac{\text{M}}{\text{④}} - \frac{\text{LF}}{\text{⑤}}$

- ① 产品系列 Series name
- ② 产品尺寸 Product dimensions
- ③ 电感值 Inductance Value: (3R3: 3.3uH 100: 10uH; 101: 100uH)
- ④ 电感公差 Inductance Tolerance: (K: 10% ; M: 20% ; N: 30%)
- ⑤ 环保产品 Lead free products.

3. 外形尺寸和材料 Appearance, Dimensions and Material

3.1 外形尺寸 Appearance and dimensions

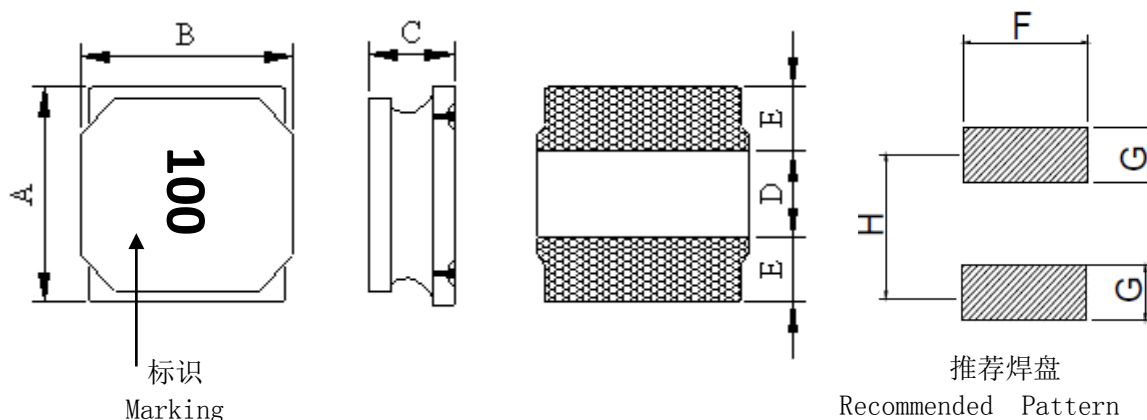

Dimensions in mm							
A	B	C	D	E	F	G	H
5.0±0.2	5.0±0.2	4.1Max.	2.0±0.3	1.5±0.3	4.0Typ.	1.5 Typ.	3.6 Typ.

3.2 材料表 Material List

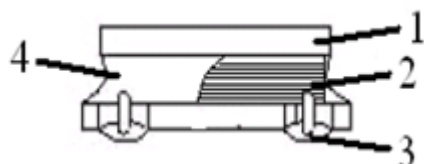

No.	项目 Item	材料 Material
1	磁材 Core	镍锌铁氧体 Ni-Zn Ferrite
2	线材 Wire	漆包铜线 Enameled Copper Wire
3	端子 Terminal Electrode	银/镍/锡/铜 Ag/Ni/Sn/Cu
4	磁胶 Magnetic Glue	环氧胶和磁粉 Epoxy resin and magnetic powder

4.测试条件 Testing Conditions

除非另有规定，否则在以下条件下测试 Unless otherwise specified

温度：常温(5 to 35°C) Temperature : Ordinary Temperature (5 to 35°C)
 湿度：常湿(25 to 85% RH) Humidity : Ordinary Humidity (25 to 85% RH)

当对测量结果有疑问时 In case of doubt

温度: 20±2°C Temperature : 20±2°C
 湿度: 60 to 75% RH Humidity : 60 to 75% RH
 大气压: 86 to 106 kPa Atmospheric Pressure : 86 to 106 kPa

5. 电性和测试仪器 Electrical Characteristics And Test Instruments

麦捷料号 Microgate Part No.	电感量 Inductance (uH)	直流电阻 DCR ±30% (Ω)	饱和电流 Isat (A) Max.	温升电流 Irms (A) Max.	自谐振频率 SRF (MHz)
MPIT5040-1R0N-LF	1.0 ±30%	0.012	7.35	4.90	117
MPIT5040-1R5N-LF	1.5 ±30%	0.015	6.30	4.30	86
MPIT5040-2R2N-LF	2.2 ±30%	0.019	4.90	3.80	50
MPIT5040-2R7N-LF	2.7 ±30%	0.022	4.30	3.60	37
MPIT5040-3R3N-LF	3.3 ±30%	0.024	3.95	3.40	32
MPIT5040-3R9N-LF	3.9 ±30%	0.027	3.55	3.20	29
MPIT5040-4R7N-LF	4.7 ±30%	0.030	3.50	3.00	28
MPIT5040-6R8M-LF	6.8 ±20%	0.043	2.90	2.50	21
MPIT5040-100M-LF	10 ±20%	0.064	2.35	2.10	18
MPIT5040-150M-LF	15 ±20%	0.086	2.00	2.00	13
MPIT5040-220M-LF	22 ±20%	0.129	1.60	1.50	11
MPIT5040-330M-LF	33 ±20%	0.188	1.30	1.20	9
MPIT5040-470M-LF	47 ±20%	0.272	1.10	1.00	7
MPIT5040-680M-LF	68 ±20%	0.400	0.90	0.80	6
MPIT5040-101M-LF	100 ±20%	0.560	0.75	0.70	5

测试仪器及说明 Test instruments and remarks

- * CHROMA 3302 仪器测试电感值及直流电阻
CHROMA 3302 meter for L and DCR.
- * CHROMA 3302 叠加 1320 仪器测试电流
CHROMA 3302 and 1320meter for IDC.
- * 电感值测试条件: 100KHz/1V.L test condition: 100KHz/1V.
- * 饱和电流: 基于电感值变化($|L_1-L|/L \leq 30\%$)
Isat:Based on inductance change ($|L_1-L|/L \leq 30\%$)
- * 温升电流: 基于温度变化($\Delta T:40^\circ\text{C}$ TYP).
Irms:Based on temperature rise($\Delta T:40^\circ\text{C}$ TYP).
- * Agilent E4991A 测试自谐振频率
Agilent E4991A for SRF

6. 工作条件 Condition of work

产品允许工作温度: $-40^\circ\text{C} \sim +125^\circ\text{C}$.

The part normal work be allowed ambient temperature: $-40^\circ\text{C} \sim +125^\circ\text{C}$.

7. 可靠性测试 Reliability and Test Condition

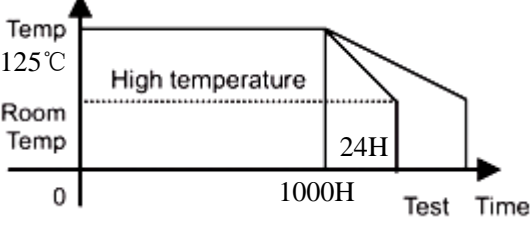
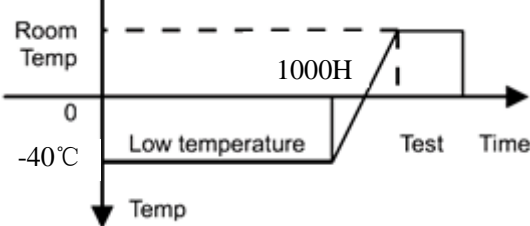
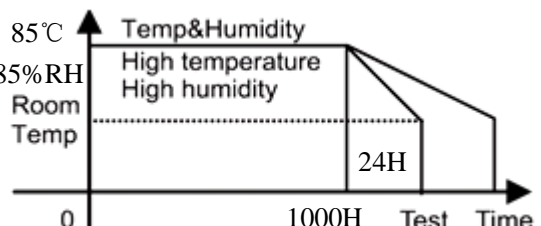
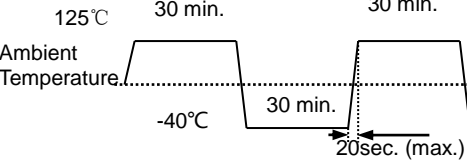
项目 Item	特性 Required Characteristics	测试方法 Test Method/Condition
高温储存 High temperature storage test	1.外形没有变形 No case deformation or change in appearance. 2.电感值变化小于等于 10% $\Delta L/L \leq 10\%$	温度: $125 \pm 2^\circ\text{C}$ Temperature: $125 \pm 2^\circ\text{C}$ 时间: 1000 小时 Time : 1000 hours 试验后在室温下放置 24 ± 4 小时后测试 Measurement at 24 ± 4 hours after test conclusion. 
低温贮存 Low temperature storage test		温度: $-40 \pm 2^\circ\text{C}$ Temperature : $-40 \pm 2^\circ\text{C}$ 时间: 1000 小时 Time : 1000 hours 试验后在室温下放置 24 ± 4 小时后测试 Measurement at 24 ± 4 hours after test conclusion. 
潮湿测试 Humidity test		温度: $25-85^\circ\text{C}$ Temperature: $25-85^\circ\text{C}$, 湿度: 85% RH Humidity :85% RH 时间: 1000 小时 Time : 1000 hours. 试验后在室温下放置 24 ± 4 小时后测试 Measurement at 24 ± 4 hours after test conclusion. 
热冲击 Thermal shock test		-40°C 放置 30 分钟然后到 125°C 放置 30 分钟为一个循环， 一共进行 1000 个循环 First -40°C for 30min. time, last 125°C 30min. time as 1 cycle. Go through 1000 cycles. 

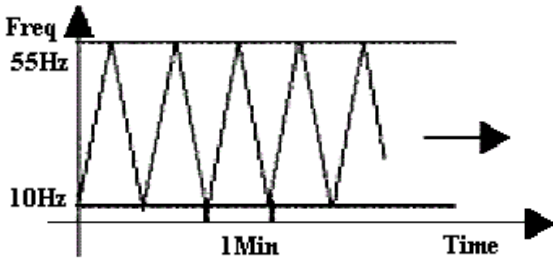
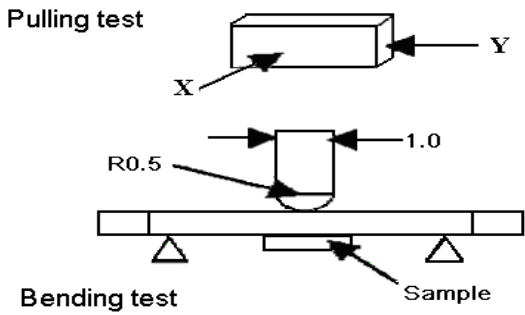
项目 Item	特性 Required Characteristics	测试方法 Test Method/Condition
可焊性 Solderability test	端子焊锡面上锡 90%以上 Terminal area must have 90% min. solder coverage.	产品沾助焊剂后放入 245±5℃ 锡中 5±0.1 秒 Dip pads in flux then dip in solder pot at 245±5℃ for 5±0.1 second. 焊料: Sn96.5%、Ag3%、Cu0.5% Solder: Sn96.5%、Ag3%、Cu0.5% 助焊剂:松香焊剂 Flux: rosin flux.
耐焊性 Heat endurance of reflow soldering		参考下页回流焊曲线,进行 3 次回流焊 回流焊最高温度: 260+5/-0℃ Refer to the next page reflow curve , Go through 3 times. The peak temperature: 260+5/-0℃
振动 Vibration test	1.外形没有变形 No case deformation or change in appearance. 2.电感值变化小于等于 10% $\Delta L/L \leq 10\%$	振幅:10~55Hz. 1.5mm,每个方向振动 2 小时,共三个方向 6 小时 Apply frequency 10~55Hz. 1.5mm amplitude in each of perpendicular direction for 2 hours in each 3 mutually perpendicular directions.(total 6 hours) 
跌落 Drop test		从距混凝土地面 1 米高自由落下, 重复 10 次 Drop 10 times on a concrete floor from a height of 1m.
端头强度 Terminal strength push test	拉力测试: 产品焊在板上后施加 17.64N 推力保持 10 秒 抗弯试验: 产品焊在板上弯曲后产品不会掉落 Pulling test: Solder the products on testing PCB using eutectic solder. Then apply a force in the direction of the arrow. 17.64N force. Keep time ≥ 10 s Bending test: Soldering the products on PCB, after the pulling test and bending test, terminal should not pull off.	拉力测试: 沿 X、Y 方向施加力 弯曲测试: 以 0.5 毫米/秒速度在 PCB 板中间点施加压力,向下弯曲 2 毫米, 保持时间:60±1 s Pulling test: The application of force X、Y direction Bend the testing PCB at middle point, the deflection shall be 2mm. Pressurizing Speed: 0.5mm/sec, Keep time: 60±1s, 
Loading at High Temperature 高温负载	1. No case deformation or change in appearance. 2. $ \Delta L /L \leq 10\%$	1. 温度: 85±2℃ Temperature: 85±2℃ 2. 时间: 1000 小时 Time : 1000 hours 3. 叠加额定电流 Apply rated current 4. 试验后在室温下放置 24±4 小时后测试 Measurement at 24±4 hours after test conclusion

8. 焊接条件 Recommended Soldering Conditions

产品可用于波峰焊和回流焊 Product can be applied to flow and reflow soldering.

[1] 焊剂 Flux, Solder

- ① 使用松香助焊剂，禁止使用卤化物含量超过 0.2wt% 的强酸性助焊剂

Use rosin-based flux. Don't use highly acidic flux with halide content exceeding 0.2wt% (chlorine conversion value).

- ② 焊料使用纯锡

Use Sn solder.

[2] 波峰焊条件 Flow soldering conditions

- ① 预热时，产品表面温度与焊料温度的温差最大不允许超出 150°C，焊接完成后冷却时，产品表面温度与溶剂温度之间的温差最大不允许超出 100°C。预热不足有可能引发产品表面裂纹，导致产品品质下降。

Pre-heating should be in such a way that the temperature difference between solder and product surface is limited to 150°C max. Cooling into solvent after soldering also should be in such a way that temperature difference is limited to 100°C max. Unwrought pre-heating may cause cracks on the product, resulting in the deterioration of products quality.

- ② 标准波峰焊曲线 Standard soldering profile.

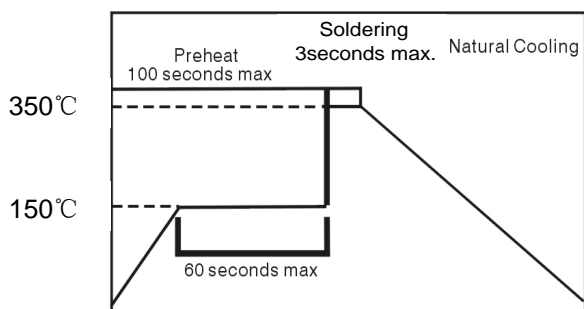

预热	150°C, 最大 1 分钟
Pre-heating	150°C, 1 minute max.
最高温度	350°C, 3 秒钟最大
Peak	350°C, 3 seconds max

[3] 回流焊条件 Reflow soldering conditions

回流焊曲线
Reflow curve

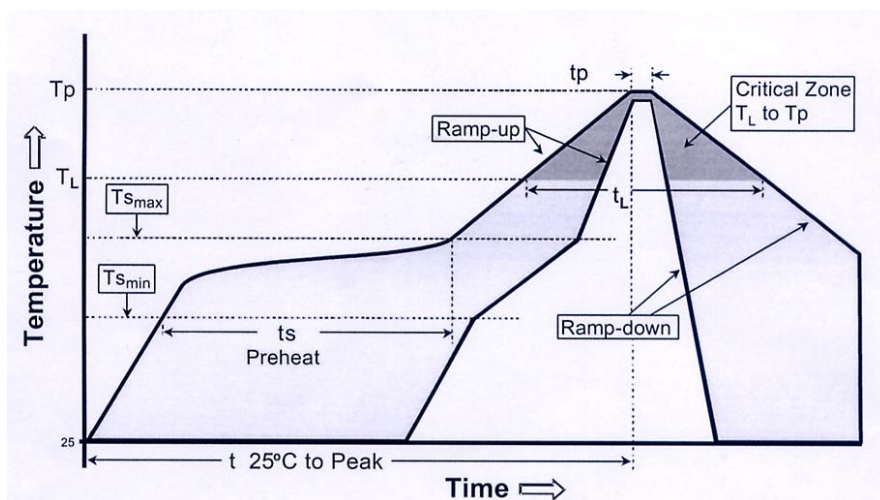

曲线特性 Profile Feature		无铅制程 Lead-Free Assembly
平均上升速率 Average Ramp-Up Rate (Ts max. to Tp)		每秒钟 3℃最大 3℃/second max.
预热 Preheat	最低温度 Temperature Min (Ts min.)	150 °C
	最高温度 Temperature Max (Ts max.)	200 °C
	时间 Time (ts min to ts max.)	60-180 seconds (秒)
持续时间 Time maintained above	温度 Temperature (TL)	217 °C
	时间 Time (tL)	60-150 seconds(秒)
峰值温度 Peak/Classification Temperature (Tp)		260 °C
峰值时间 Peak/Classification Time (Tp)		3-4 seconds(秒)
Time within 5 °C of actual Peak Temperature (Tp)		20-40 seconds(秒)
缓降率 Ramp-Down Rate		每秒钟 6℃最大 / 6℃/second max.
从 25 °C 升至峰值温度时间 Time 25 °C to Peak Temperature		8 分钟最长 8 minutes max.

注意：所有的温度参考上表，测量温度为产品表面温度

Note: All temperatures refer to topside of the package, measured on the package body surface.

[4]手工返工 The method on Re-work with using the iron:

当使用电烙铁进行手工焊接时，以下条件必须严格遵守

The following conditions must be strictly followed when using a soldering iron

预热 Pre-heating	150°C, 1 分钟 / 150°C, 1 minute
尖端温度 Tip temperature	350°C 最高 / 350°C max
输出功率 Soldering iron output	80w 最大/80w max
电烙铁头尖端尺寸 End of soldering iron	φ1mm 最大 /φ1mm max
焊接时间 Soldering time	3 秒种最长/3 seconds max

产品脱离电路板后请不要再次使用

Product once removes from the circuit board may not be used again.

9. 包装信息 Package Information

9.1 编带尺寸(单位: mm) Dimension of tape (Unit: mm)

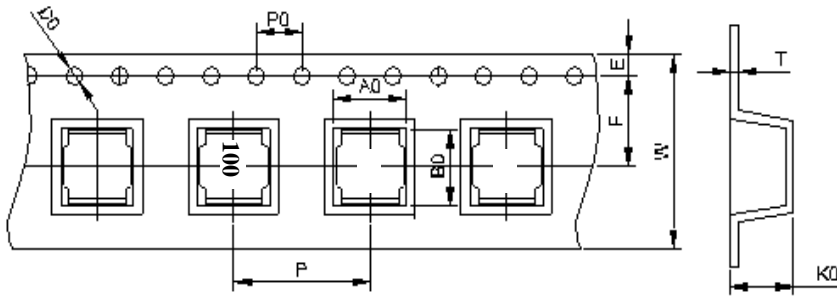

W	A0	B0	K0	E	F	P	P0	D0	T
12±0.3	5.4±0.1	5.4±0.1	4.4±0.1	1.75±0.1	5.5±0.1	8.0±0.1	4.0±0.1	1.5±0.1	0.40±0.05

9.2 带轮尺寸 Dimension of reel (Unit: mm)

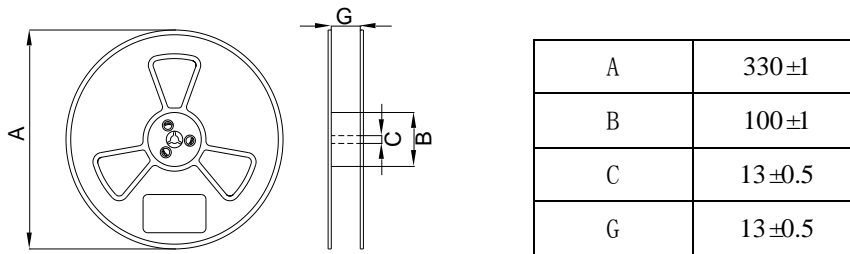

9.3 编带简图及拉伸方向 Taping figure and drawing direction

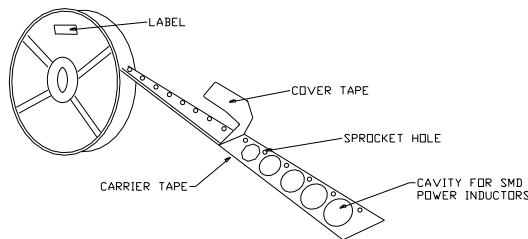

9.4 包装数量 Packaging quantities: 1500PCS/Reel.

9.5 盖带剥离力 Peeling strength of cover tape:

上盖带拉力在 0.1N 至 1.3N 之间

The peel force of top cover tape shall be between 0.1N to 1.3N

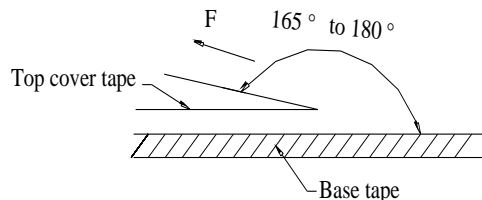

室温 Room Temp. (°C)	湿度 Room Humidity (%)	气压 Room aim (hpa)	速度 Peel Speed Mm/min
5-35	45-85	860-1060	300

10. 产品外观检验标准 Visual inspection standard of product

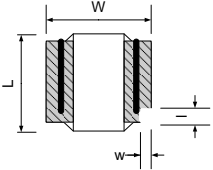
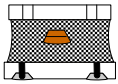
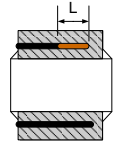
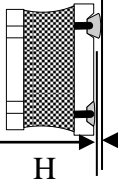
No.	缺陷 Defect Item	图示 Graphic	拒收标准 Rejection identification	验收水准 Acceptance
1	磁体缺陷 Core defect		$l > L/6$ 或 $w > W/6$, 不合格. $l > L/6$ or $w > W/6$, NG.	AQL=0.65
2	缺胶 Missing resin		缺胶面积超过单一面积的 1/3, 不合格 The area of missing resin more than 1/3 single face, NG	AQL=0.65
3	冷焊 Cold solder		L 超过 1 毫米, 不合格 L more than 1 mm, NG.	AQL=0.65
4	平整度 Solder uneven		$H > 0.1\text{mm}$. 不合格 $H > 0.1\text{mm}$. NG.	AQL=0.65

11. 存储 Storage

(1) 保管期限 Storage period

距麦捷出厂检验时间 12 个月内，产品可以使用；检验时间可以通过包装外侧标记的检验号确认；若时间超出六个月，应检查焊接性能后方可使用。

Products which inspected in MICROGATE over 12 months ago should be examined and used, which can be confirmed with inspection No. marked on the container. Solder ability should be checked if this period is exceeded.

(2) 保管条件 Storage conditions

① 存放货物的库房应满足以下条件

Products should be storage in the warehouse on the following conditions

温度 Temperature: $-10^{\circ}\text{C}\sim 40^{\circ}\text{C}$

湿度 Humidity : $\leq 70\%$ relative humidity

不允许温、湿度有极剧变化。

No rapid change on temperature and humidity

② 禁止将产品保管在腐蚀性物质中，例如硫磺、氯气或者酸，否则将引起端头氧化，导致降低焊接性。

Don't keep products in corrosive gases such as sulfur, chlorine gas or acid, or it may cause oxidization of electrode, resulting in poor solder ability.

③ 为了避免受潮气、灰尘等物质的影响，产品应保管于货架上。

Products should be storage on the palette for the prevention of the influence from humidity, dust and so on.

④ 产品保管在库房中时，应避免热冲击，振动以及直接光照等等。

Products should be storage in the warehouse without heat shock, vibration, direct sunlight and so on.

⑤ 产品应密封包装

Products should be storage under the airtight packaged condition.

X-ON Electronics

Largest Supplier of Electrical and Electronic Components

Click to view similar products for [Fixed Inductors](#) category:

Click to view products by [microgate](#) manufacturer:

Other Similar products are found below :

[MLZ1608M6R8WTD25](#) [MLZ1608N6R8LT000](#) [MLZ1608N3R3LTD25](#) [MLZ1608N3R3LT000](#) [MLZ1608N150LT000](#)
[MLZ1608M150WTD25](#) [MLZ1608M3R3WTD25](#) [MLZ1608M3R3WT000](#) [MLZ1608M150WT000](#) [MLZ1608A1R5WT000](#)
[MLZ1608N1R5LT000](#) [B82432C1333K000](#) [PCMB053T-1R0MS](#) [PCMB053T-1R5MS](#) [PCMB104T-1R5MS](#) [CR32NP-100KC](#) [CR32NP-151KC](#) [CR32NP-180KC](#) [CR32NP-181KC](#) [CR32NP-1R5MC](#) [CR32NP-390KC](#) [CR32NP-3R9MC](#) [CR32NP-680KC](#) [CR32NP-820KC](#)
[CR32NP-8R2MC](#) [CR43NP-390KC](#) [CR43NP-560KC](#) [CR43NP-680KC](#) [CR54NP-181KC](#) [CR54NP-470LC](#) [CR54NP-820KC](#) [CR54NP-8R5MC](#)
[MGDQ4-00004-P](#) [MGDU1-00016-P](#) [MHL1ECTTP18NJ](#) [MHL1JCTTD12NJ](#) [PE-51506NL](#) [PE-53601NL](#) [PE-53630NL](#) [PE-53824SNLT](#) [PE-62892NL](#) [PE-92100NL](#) [PG0434.801NLT](#) [PG0936.113NLT](#) [PM06-2N7](#) [PM06-39NJ](#) [HC2LP-R47-R](#) [HC2-R47-R](#) [HC3-2R2-R](#) [HC8-1R2-R](#)