

## DC/DC Step up Converter ME2108 Series

### General Description:

**ME2108 Series** is a PFM Step-up DC/DC converter IC with low supply current by CMOS process. High frequency noise that occurs during switching is reduced by using advanced circuit designed, output voltage is programmable in 0.1V steps between 2.0~7.0V and maximum frequency is 180KHz(Typ.). A low ripple, high efficiency step-up DC/DC converter can be constructed of ME2108Xxx with only three external components. Also available is a CE(chip enable) function that reduce power dissipation During shut-down mode. ME2108Xxx is suitable for use with battery-powered instruments with low noise and low supply current.

### Features:

- Low ripple and low noise
- Operating voltage range: 0.9V~6.5V
- Output voltage range: 2.0V~7.0V(step 0.1V)
- Output voltage accuracy:  $\pm 2.5\%$
- Output Current: if  $V_{in}=3.0V$  and  $V_{out}=5.0V$ , then  $I_{out}=400mA$
- Low start voltage:  $\leq 0.9V$ (at  $I_{out}=1mA$ );
- Maximum oscillator frequency: 180KHz(Typ.)
- High Efficiency: 85%(Type)
- PACKAGE: SOT23, SOT89

### Selection Guide:

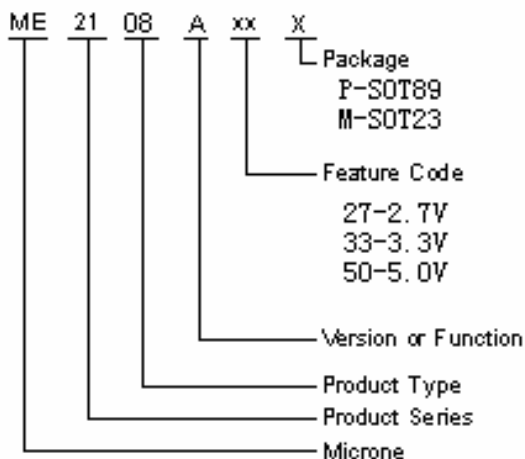

### Applications:

- Power source for battery-powered equipment
- Power source for wireless mouse, wireless keyboard, toys, cameras, camcorders, VCRs, PDAs, and hand-held communication equipment
- Power source for appliances which require higher cell voltage than that of batteries used in the appliances

TYPE	POSTFIX	PACKAGE	SWITCHING TRANSISTOR	CE FUNCTION	FEATURES
ME2108Axx	M3	SOT23-3	Build in Transistor	No	Lx
	P	SOT89-3			
ME2108Bxx	M3	SOT23-3	External Transistor	No	Ext
	P	SOT89-3			
ME2108Cxx	M5	SOT23-5	Build in Transistor	Yes	Lx CE
	P	SOT89-5			
ME2108Dxx	M5	SOT23-5	External Transistor	Yes	Ext CE
	P	SOT89-5			
ME2108Dxx	M5	SOT23-5	External Transistor	Yes	Ext

### Pin Configuration:

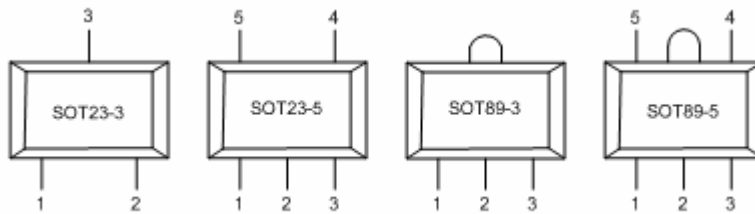

### Pin Assignment:

#### ME2108Axx

PIN Number		PIN NAME	FUNCTION
SOT23-3	SOT89-3		
1	1	Vss	Ground
3	2	Vout	Output voltage monitor, IC internal power supply
2	3	Lx	Switch

#### ME2108Bxx

PIN Number		PIN NAME	FUNCTION
SOT23-3	SOT89-3		
1	1	Vss	Ground
3	2	Vout	Output voltage monitor, IC internal power supply
2	3	Ext	External switch transistor drive

#### ME2108Cxx

PIN Number		PIN NAME	FUNCTION
SOT23-5	SOT89-5		
4	5	Vss	Ground
2	2	Vout	Output voltage monitor, IC internal power supply
5	4	Lx	Switch
1	3	CE	Chip enable
3	1	NC	NC

ME2108Dxx

PIN Number		PIN NAME	FUNCTION
SOT23-5	SOT89-5		
4	5	Vss	Ground
2	2	Vout	Output voltage monitor, IC internal power supply
5	4	Ext	External switch transistor drive
1	3	CE	Chip enable
3	1	NC	NC

ME2108Fxx

PIN Number		PIN NAME	FUNCTION
SOT23-5			
1		FB	Feed Back
2		Vdd	Output voltage monitor, IC internal power supply
3		NC	NC
4		Vss	Ground
5		EXT	External switch transistor drive

Block Diagram:

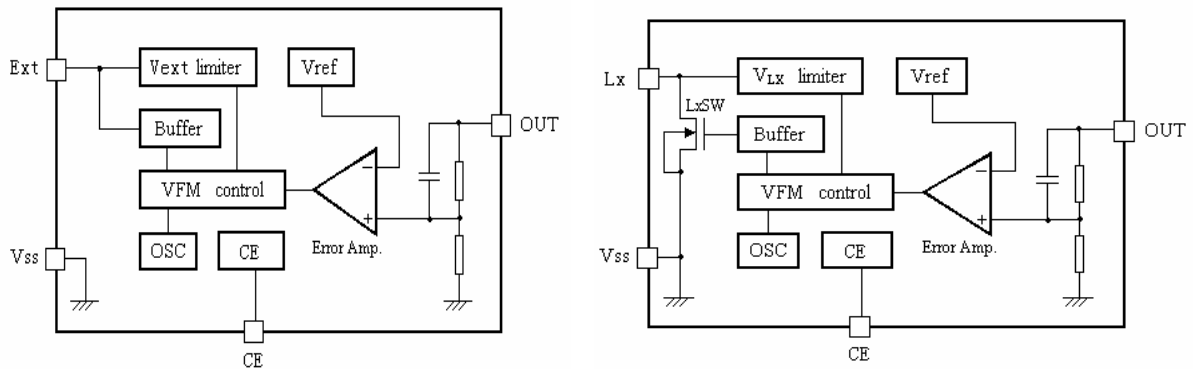

Absolute Maximum Ratings:

PARAMETER	SYMBOL	RATINGS	UNITS
V <sub>IN</sub> Input Voltage	V <sub>IN</sub>	6.5	V
L <sub>x</sub> Pin voltage	V <sub>LX</sub>	6.5	V
EXT Pin voltage	V <sub>EXT</sub>	-0.3~Vout+0.3	V
CE Pin voltage	V <sub>CE</sub>	-0.3~Vout+0.3	V
L <sub>x</sub> Pin current	I <sub>LX</sub>	600	mA
EXT Pin current	I <sub>EXT</sub>	±30	mA
V <sub>dd</sub> input voltage	V <sub>dd</sub>	6.5	V
Continuous Total Power Dissipation	SOT23	Pd	300
	SOT89	Pd	500
Operating Ambient Temperature	T <sub>Opr</sub>	-25~+85	°C
Storage Temperature	T <sub>stg</sub>	-40~+125	°C
Soldering temperature and time	T <sub>solder</sub>	260°C, 10s	

## Electrical Characteristics:

Measuring conditions: Unless otherwise specified,  $V_{IN}=V_{out} \times 0.6$ ,  $V_{SS}=0V$ ,  $I_{OUT}=10mA$ ,  $T_{opt}=25^{\circ}C$ 。

ME2108Axx/Cxx  $F_{osc}=180kHz$

SYMBOL	PARAMETER	CONDITIONS	MIN	TYP	MAX	UNITS
$V_{OUT}$	Output Voltage		$V_{out} \times 0.975$	$V_{out}$	$V_{out} \times 1.025$	V
$V_{start}$	Oscillation Start-up Voltage	$I_{OUT}=1mA$ , $V_{IN}: 0 \rightarrow 2V$		0.8	0.9	V
$V_{hold}$	Oscillation Hold Voltage	$I_{OUT}=1mA$ , $V_{IN}: 2 \rightarrow 0V$		0.45		V
$I_{DD1}$	Supply Current 1	No external component $V_{out}=V_{out} \times 0.95$ ,		50		$\mu A$
$I_{DD2}$	Supply Current 2	$V_{out}=V_{out}+0.5V$		9		$\mu A$
$I_{LX}$	Lx Switching Current	$V_{LX}=0.4V$ , $V_{out}=V_{out} \times 0.95$		360		mA
$I_{LXleak}$	Lx Leakage Current	$V_{out}=V_{LX}=6V$			0.5	$\mu A$
$F_{osc}$	Oscillation Frequency	$V_{out}=\text{set}$ $V_{out} \times 0.95$		180		kHz
Maxdty	Duty Ratio	on( $V_{LX}$ “L”)side		84		%
EFFI	Efficiency			85		%

ME2108Bxx/Dxx  $F_{osc}=180kHz$

SYMBOL	PARAMETER	CONDITIONS	MIN	TYP	MAX	UNITS
$V_{OUT}$	Output Voltage		$V_{out} \times 0.975$	$V_{out}$	$V_{out} \times 1.025$	V
$V_{start}$	Oscillation Start-up Voltage	$I_{OUT}=1mA$ , $V_{IN}: 0 \rightarrow 2V$		0.8	0.9	V
$V_{hold}$	Oscillation Hold Voltage	$I_{OUT}=1mA$ , $V_{IN}: 2 \rightarrow 0V$		0.45		V
$I_{DD1}$	Supply Current 1	No external component $V_{out}=V_{out} \times 0.95$ ,		80		$\mu A$
$I_{DD2}$	Supply Current 2	$V_{out}=V_{out}+0.5V$		12		$\mu A$
$I_{LX}$	Lx Switching Current	$V_{LX}=0.4V$ , $V_{out}=V_{out} \times 0.95$		360		mA
$I_{LXleak}$	Lx Leakage Current	$V_{out}=V_{LX}=6V$			0.5	$\mu A$
$F_{osc}$	Oscillation Frequency	$V_{out}=\text{set}$ $V_{out} \times 0.95$		180		kHz
Maxdty	Duty Ratio	on( $V_{LX}$ “L”)side		84		%
EFFI	Efficiency			85		%

ME2108F VFB=3.3V, Fosc=180kHz

SYMBOL	PARAMETER	CONDITIONS	MIN	TYP	MAX	UNITS
$V_{FB}$	Output Feedback Voltage		3.22	3.3	3.38	V
$V_{start}$	Oscillation Start-up Voltage	$I_{OUT}=1mA$ , $V_{IN}: 0 \rightarrow 2V$		0.8	0.9	V
$V_{hold}$	Oscillation Hold Voltage	$I_{OUT}=1mA$ , $V_{IN}: 2 \rightarrow 0V$		0.45		V
$I_{DD1}$	Supply Current 1	No external component $V_{out}=V_{out} \times 0.95$ ,		80		$\mu A$
$I_{DD2}$	Supply Current 2	$V_{out}=V_{out}+0.5V$		10		$\mu A$
$I_{LX}$	Lx Switching Current	$V_{LX}=0.4V$ , $V_{out}=V_{out} \times 0.95$		360		mA
$I_{LXleak}$	Lx Leakage Current	$V_{out}=V_{LX}=6V$			0.5	$\mu A$
$F_{osc}$	Oscillation Frequency	$V_{out}=\text{set } V_{out} \times 0.95$		180		kHz
Maxdty	Duty Ratio	on( $V_{LX}$ “L”)side		84		%
EFFI	Efficiency			85		%

Note: 1、Diode use Schottky diode such as IN5817 or IN5819 (forward voltage drop:0.2V)

2、Inductor: 33 $\mu H$  ( $r < 0.5\Omega$ )

3、Capacitor: Tantalum type 100 $\mu F$

## Operation:

ME2108 step-up DC/DC converter charges energy in the inductor when Lx Transistor is on, and discharges the energy with the addition of the energy from input power source thereto, so that a higher output voltage than the input voltage is obtained. Following is the operation diagram.

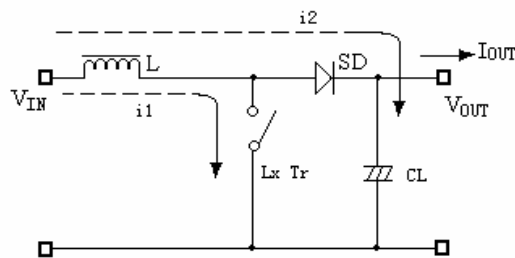

Switching DC/DC Step up Converter operating process

## Selection of Peripheral Components and Application Notes

Peripheral components should be selected carefully because they are greatly affect the performances of ME2108:

- Use capacitor with a capacity of 10 $\mu$ F or more ( too small capacity will lead to high output ripple), and with good frequency characteristics ( it is better to use Tantalum type). Besides, it is recommended the use of a capacitor with an allowable voltage which is at least three times the output set voltage. This is because there may be the case where a spike-shaped high voltage is generated by the inductor when L<sub>X</sub> transistor is turned OFF.
- Choose such an inductor that has sufficiently small d.c. resistance and large allowable current, and hardly reaches magnetic saturation. When the inductance value of the inductor is small, there may be the case where I<sub>LX</sub> exceeds the absolute maximum ratings at the maximum load.
- Use a diode of a Schottky type with high switching speed.

### PCBLAYOUT:

- Set external components as close as possible to the IC and minimize the connection between the components and the IC. In particular, when an external component is connected to V<sub>OUT</sub> Pin, make minimum connection with the capacitor.
- Make V<sub>SS</sub> pin sufficient grounding, otherwise, the zero level within IC will varied with the switching current. This may result in unstable operation of IC.

## Typical Applications:

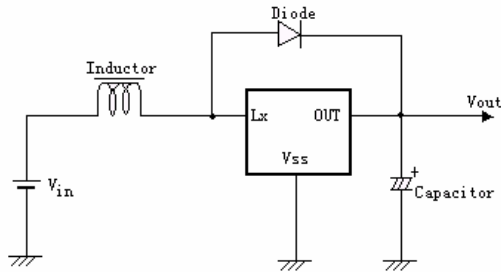

For use Build\_in Transistor

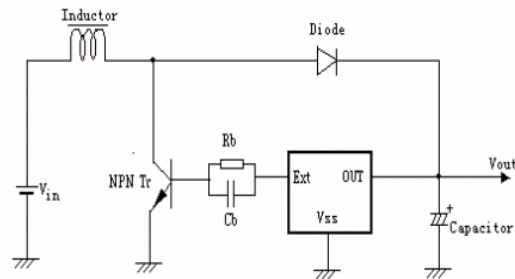

For use External Transistor

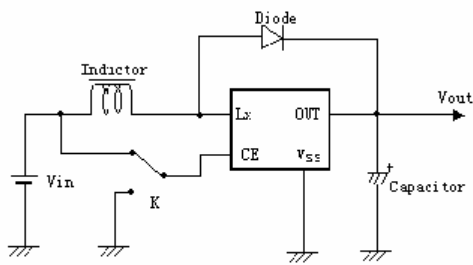

For use Chip Enable(CE)

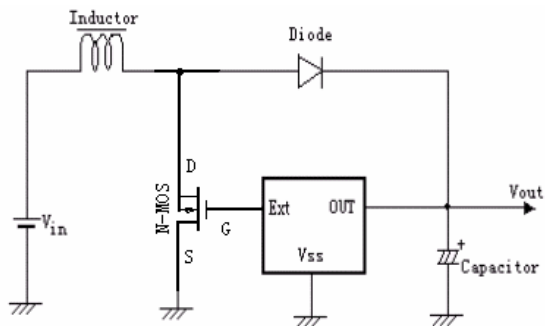

For use external transistor(N\_MOS)

Components: Inductor: 47uH(Sumida )

Diode: IN5817、IN5819

Capacitor: 47uF/16V(Tantalum type)

Transistor: 2SD1628G、2SD3279

NMOS: AAT9460、XP151、XP161

Base Resistor(Rb): 1KΩ

Base Capacitor(Cb): 2200pF

$R_{FB}$  :Set up so that  $R_{FB1}/R_{FB2}=V_{out} / V_{FB}-1$ ( $V_{out}$ =set-up output voltage),

Please use with  $R_{FB1}+R_{FB2}\leq 2M\Omega$ ;

$C_{FB}$ :Set up that  $Fzfb=1/(2\times\pi\times C_{FB}\times R_{FB1})$  is within the Adjustments necessary in respect of  $L,C_L$ .

## Type Characteristics

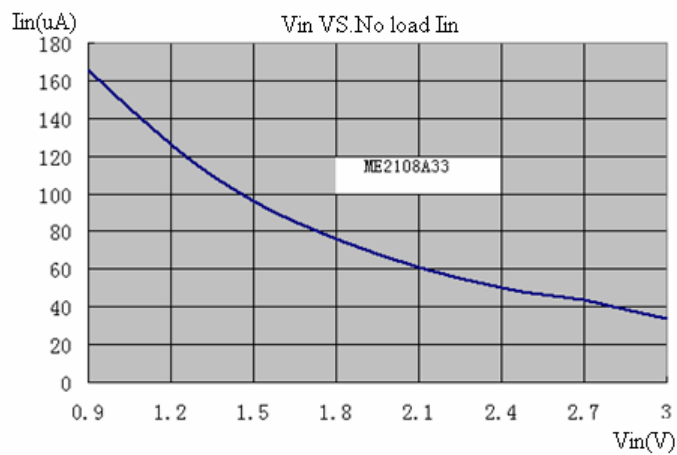
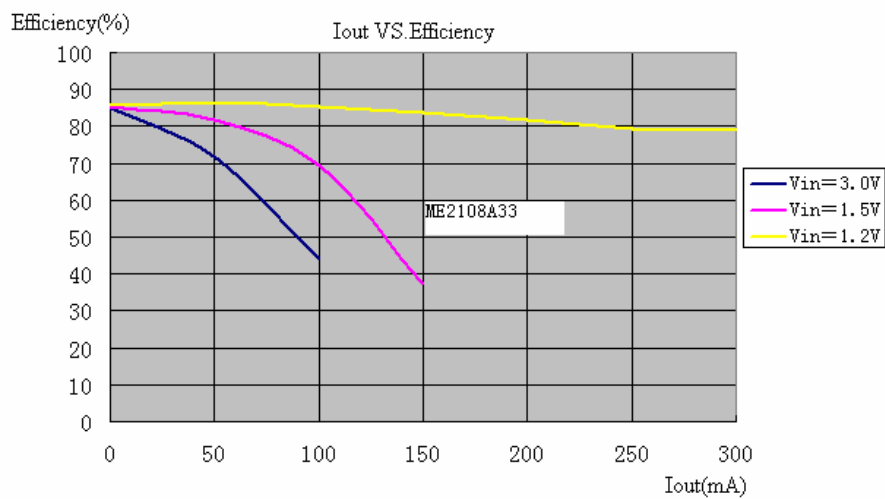
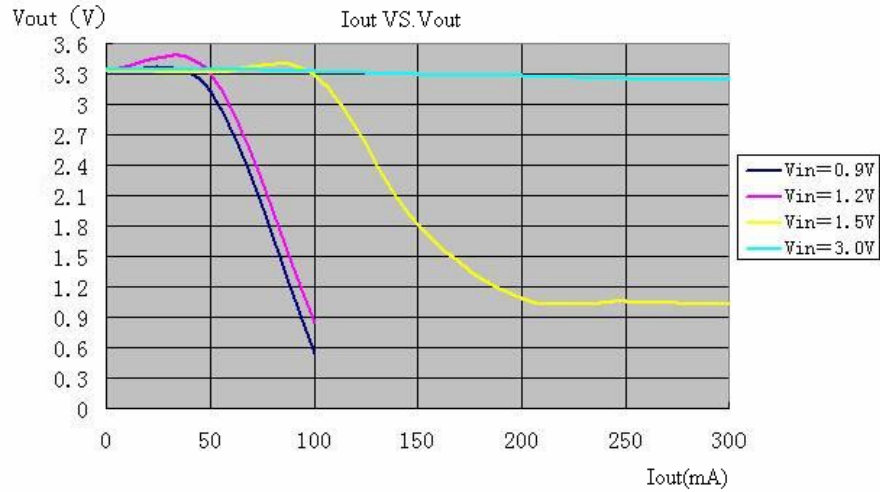



$L=47\mu\text{H}$ ,  $C_{out}=47\mu\text{F}$ ,  $V_{out}=100\mu\text{F}$ , SD: 1N5717/5819

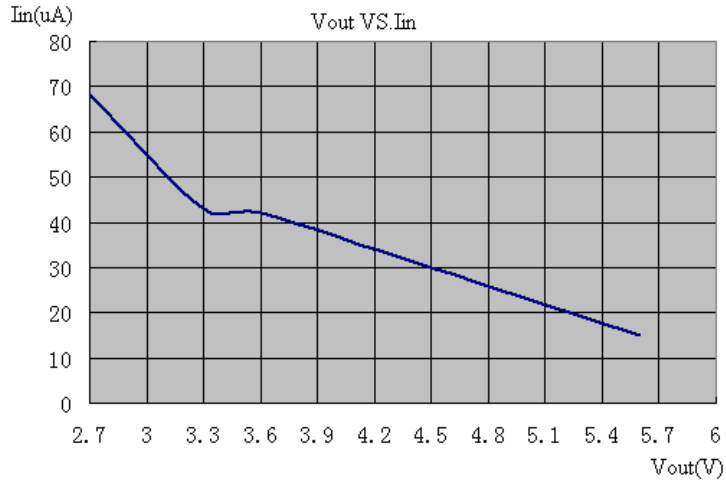

$V_{DD}=V_{OUT}*0.95$

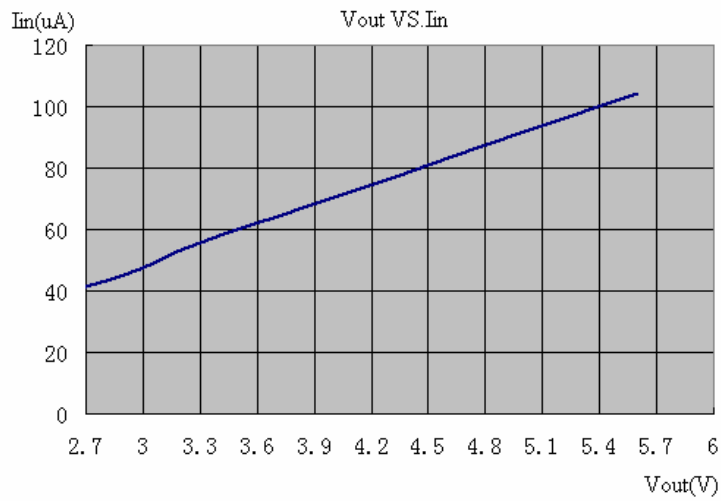

$$V_{DD} = V_{OUT} + 0.5$$

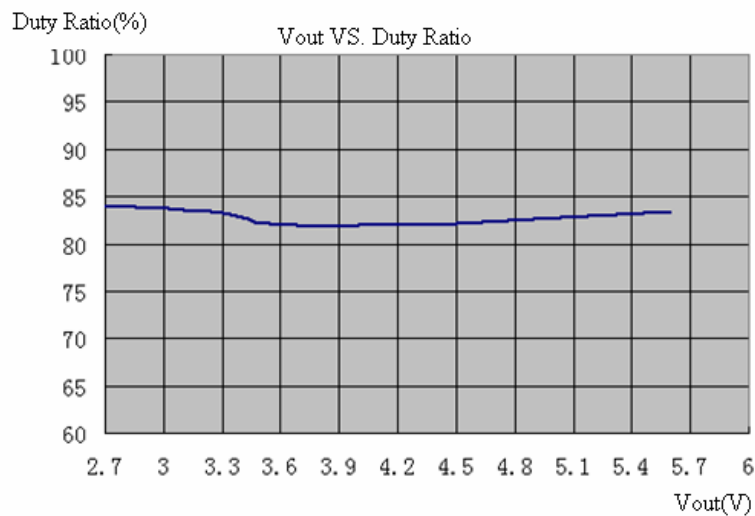
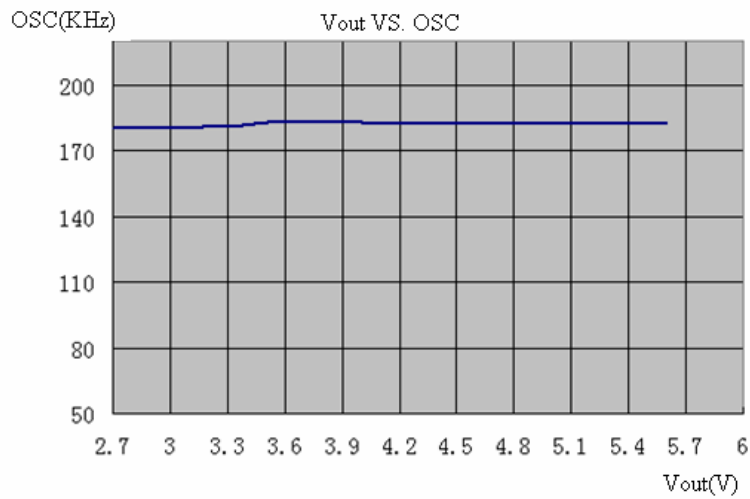
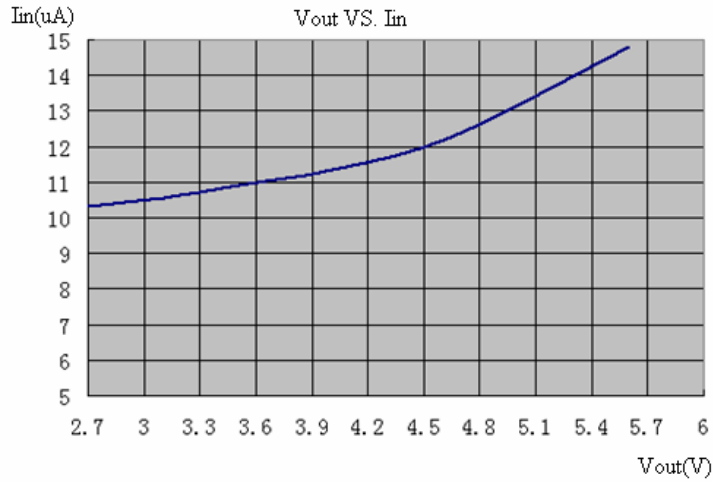

Package Dimensions:

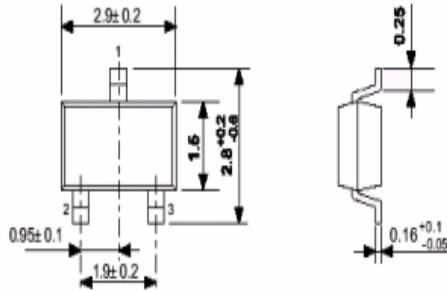

SOT23-3

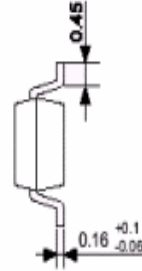
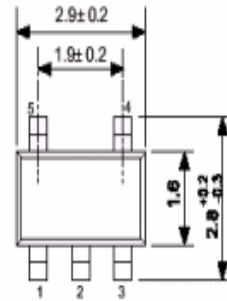

SOT23-5

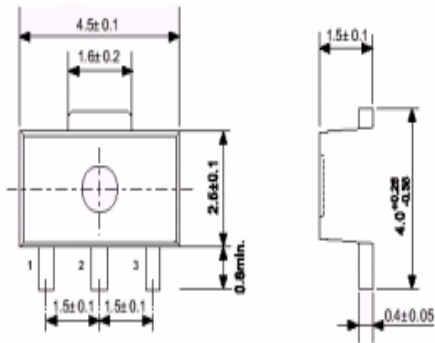
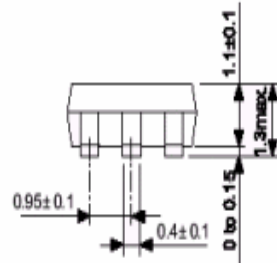
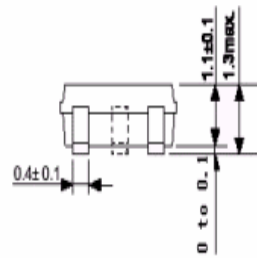

SOT89-3

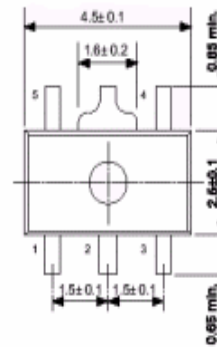

SOT89-5

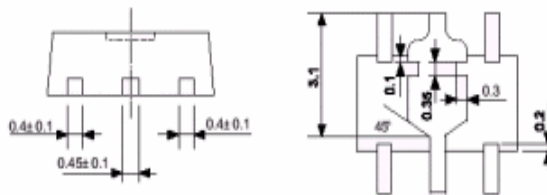
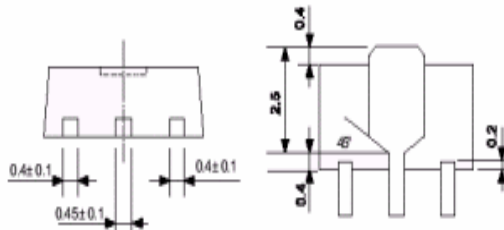

- The information described herein is subject to change without notice.
- Nanjing Micro One Electronics Inc is not responsible for any problems caused by circuits or diagrams described herein whose related industrial properties, patents, or other rights belong to third parties. The application circuit examples explain typical applications of the products, and do not guarantee the success of any specific mass-production design.
- Use of the information described herein for other purposes and/or reproduction or copying without the express permission of Nanjing Micro One Electronics Inc is strictly prohibited.
- The products described herein cannot be used as part of any device or equipment affecting the human body, such as exercise equipment, medical equipment, security systems, gas equipment, or any apparatus installed in airplanes and other vehicles, without prior written permission of Nanjing Micro One Electronics Inc.
- Although Nanjing Micro One Electronics Inc exerts the greatest possible effort to ensure high quality and reliability, the failure or malfunction of semiconductor products may occur. The user of these products should therefore give thorough consideration to safety design, including redundancy, fire-prevention measures, and malfunction prevention, to prevent any accidents, fires, or community damage that may ensue.

## X-ON Electronics

Largest Supplier of Electrical and Electronic Components

*Click to view similar products for [Switching Controllers](#) category:*

*Click to view products by [Micro One](#) manufacturer:*

Other Similar products are found below :

[LV5065VB-TLM-H](#) [LV5066V-TLM-H](#) [LV5725JAZ-AH](#) [633888R](#) [MP2908AGF](#) [AZ7500EP-E1](#) [NCP1012AP133G](#) [NCP1217P133G](#)  
[NCP1218AD65R2G](#) [NCP1234AD100R2G](#) [NCP1244BD065R2G](#) [NCP1336ADR2G](#) [NCP1587GDR2G](#) [NCP6153MNTWG](#)  
[NCP81005MNTWG](#) [NCP81101BMNTXG](#) [NCP81205MNTXG](#) [HV9123NG-G-M934](#) [IR35207MTRPBF](#) [ISL6367HIRZ](#) [CAT874-80ULGT3](#)  
[SJ6522AG](#) [SJE6600](#) [TLE63893GV50XUMA1](#) [IR35215MTRPBF](#) [SG3845DM](#) [NCP1216P133G](#) [NCP1236DD65R2G](#) [NCP1247BD100R2G](#)  
[NCP1250BP65G](#) [NCP4202MNR2G](#) [NCP4204MNTXG](#) [NCP6132AMNR2G](#) [NCP81141MNTXG](#) [NCP81142MNTXG](#) [NCP81172MNTXG](#)  
[NCP81203MNTXG](#) [NCP81206MNTXG](#) [NX2155HCUPTR](#) [UC3845ADM](#) [UBA2051C](#) [IR35201MTRPBF](#) [MAX8778ETJ+](#)  
[MAX17500AAUB+T](#) [MAX17411GTM+T](#) [MAX16933ATIR/V+](#) [NCP1010AP130G](#) [NCP1063AD100R2G](#) [NCP1216AP133G](#)  
[NCP1217AP100G](#)