



## 1A Adjustable Voltage High Speed LDO Regulators ME6118 Series

### General Description

The ME6118 series are highly accurate, low noise, LDO Voltage Regulators that are capable of providing an output current that is in excess of 1A with a maximum dropout voltage of 1.3V at 1A (ME6118A33). This series contains four fixed output voltages of 1.2V, 1.8V, 2.5V and 3.3V that have no minimum load requirement to maintain regulation. On chip trimming adjusts the reference/output voltage to within  $\pm 2\%$  accuracy. Internal protection features consist of output current limiting, safe operating area compensation, and thermal shutdown. The ME6118 series can operate with up to 18V input.

### Features

- Output Current in Excess of 1A
- Dropout Voltage: 80mV @  $I_{OUT} = 100\text{mA}$  (ME6118A33)
- Operating Voltage Range: 2.5V ~ 18V
- Highly Accuracy:  $\pm 2\%$
- Adjustable Output Voltage Option
- Standby Current: 52uA (TYP.)
- High Ripple Rejection: 70dB @ 1KHz (ME6118A33)
- Line Regulation: 2mV (TYP.)
- Temperature Stability  $\leq 0.5\%$
- Thermal Shutdown Protection: 160°C

### Typical Application

- Consumer and Industrial Equipment Point of Regulation
- Switching Power Supply Post Regulation
- Hard Drive Controllers
- Battery Chargers

### Package

- 3-pin SOT223, SOT23-3, SOT89-3, TO252-2L

### Typical Application Circuit

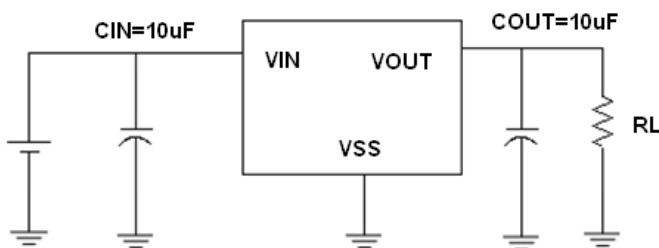

## Selection Guide

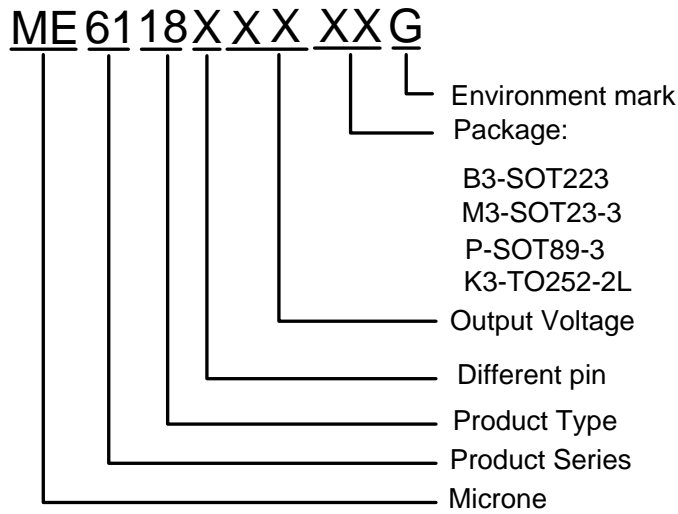

product series	product description
ME6118A12B3G	V <sub>OUT</sub> =1.2V; Package: SOT223
ME6118A18B3G	V <sub>OUT</sub> =1.8V; Package: SOT223
ME6118A25B3G	V <sub>OUT</sub> =2.5V; Package: SOT223
ME6118A33B3G	V <sub>OUT</sub> =3.3V; Package: SOT223
ME6118A50B3G	V <sub>OUT</sub> =5.0V; Package: SOT223
ME6118E25B3G	V <sub>OUT</sub> =2.5V; Package: SOT223; Different pin
ME6118E33B3G	V <sub>OUT</sub> =3.3V; Package: SOT223; Different pin
ME6118A33M3G	V <sub>OUT</sub> =3.3V; Package: SOT23-3
ME6118H33M3G	V <sub>OUT</sub> =3.3V; Package: SOT23-3; Different pin
ME6118A33PG	V <sub>OUT</sub> =3.3V; Package: SOT89-3
ME6118L50K3G	V <sub>OUT</sub> =5.0V; Package: TO252-2L; Different pin

**NOTE:** At present ,there are five kinds of voltage value: 1.2V、1.8V、2.5V、3.3V、5.0V。  
If you need other voltage and package, please contact our sales staff。

## Pin Configuration

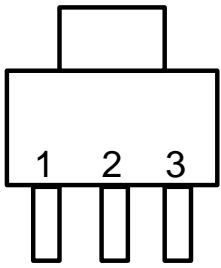

SOT223

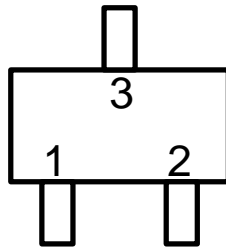

SOT23-3

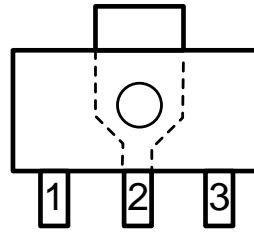

SOT89-3

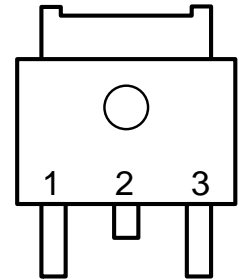

TO252-2L

## Pin Assignment

### ME6118AXX

Pin Number				Pin Name	Functions
SOT223	SOT89-3	TO252-2L	SOT23-3		
1	1	1	1	GND	Ground
2	3	2	2	$V_{OUT}$	Output
3	2	3	3	$V_{IN}$	Power Input

### ME6118EXX

Pin Number		Pin Name	Functions
SOT223	TO252-2L		
1	1	GND	Ground
2	2	$V_{IN}$	Power Input
3	3	$V_{OUT}$	Output

### ME6118HXX

Pin Number		Pin Name	Functions
SOT223	TO252-2L		
1	1	$V_{OUT}$	Output
2	2	GND	Ground
3	3	$V_{IN}$	Power Input

### ME6118LXX

Pin Number		Pin Name	Functions
SOT223	TO252-2L		
1	1	$V_{IN}$	Power Input
2	2	GND	Ground
3	3	$V_{OUT}$	Output

## Block Diagram

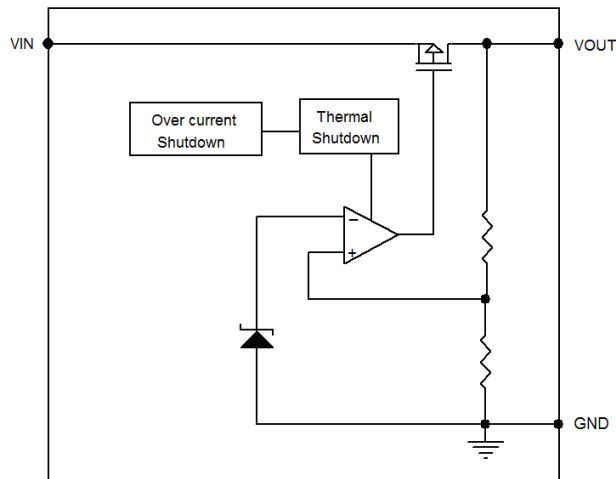

## Absolute Maximum Ratings

Parameter		Symbol	Ratings	Units
Input Voltage		$V_{IN}$	18	V
Output Current		$I_{OUT}$	1.1	A
Output Voltage		$V_{OUT}$	$V_{SS}-0.3 \sim V_{IN}+0.3$	V
ThetaJa	SOT223	$\theta_{ja}$	70	°C/W
	SOT89-3		100	
	TO252-2L		56	
	SOT23-3		230	
Operating Temperature Range		$T_{OPR}$	-40~+125	°C
Storage Temperature Range		$T_{STG}$	-40~+150	°C
Lead Temperature			260°C, 4sec	

## Electrical Characteristics

ME6118A12/E12/H12/L12 (Packages:SOT223 , SOT89-3,TO252-2L)

( $V_{IN}=V_{OUT}+1.3V$ ,  $C_{IN}=C_L=10\mu F$ ,  $T_a=25^\circ C$ , unless otherwise noted)

Parameter	Symbol	Conditions	Min.	Typ.	Max.	Units
Output Voltage	$V_{OUT(E)}$ (Note 2)	$I_{OUT}=10mA$ , $V_{IN}=V_{OUT}+1.3V$	X 0.98	$V_{OUT(T)}$ (Note 1)	X 1.02	V
Maximum Output Current	$I_{OUTMAX}$	$V_{IN}=V_{OUT}+1.3V$		800		mA
Load Regulation	$\Delta V_{OUT}$	$V_{IN}=V_{OUT}+1.3V$ , $1mA \leq I_{OUT} \leq 800mA$		3		mV
Dropout Voltage (Note 3)	$V_{DIF1}$	$I_{OUT}=100mA$		195		mV
	$V_{DIF2}$	$I_{OUT}=400mA$		665		mV
	$V_{DIF3}$	$I_{OUT}=800mA$		1250		mV
	$V_{DIF4}$	$I_{OUT}=1000mA$		1600		mV
Quiescent Current	$I_{SS}$	$V_{IN}=V_{OUT}+1.3V$		53		uA
Line Regulation	$\Delta V_{OUT}$	$I_{OUT}=0mA$		2		mV

		$V_{OUT}+1.3V \leq V_{IN} \leq 18V$			
Thermal Shutdown Protection	$T_{sd}$	$I_{OUT}=10mA,$ $V_{IN}= V_{OUT}+1.3V$		155	$^{\circ}C$
Over Current Protection	$I_{limit}$	$V_{IN}=3V$		1.1	A

### ME6118A18/E18/H18/L18 (Packages:SOT223 , SOT89-3,TO252-2L)

( $V_{IN}= V_{OUT}+1.2V$ ,  $C_{IN}=C_L=10\mu F$ ,  $T_a=25^{\circ}C$ , unless otherwise noted)

Parameter	Symbol	Conditions	Min.	Typ.	Max.	Units
Output Voltage	$V_{OUT}(E)$ (Note 2)	$I_{OUT}=10mA$ $V_{IN}= V_{OUT}+1.2V$	X 0.98	$V_{OUT}(T)$ (Note 1)	X 1.02	V
Maximum Output Current	$I_{OUTMAX}$	$V_{IN}= V_{OUT}+1.2V$		800		mA
Load Regulation	$\Delta V_{OUT}$	$V_{IN}= V_{OUT}+1.2V$ , $1mA \leq I_{OUT} \leq 800mA$		5		mV
Dropout Voltage (Note 3)	$V_{DIF1}$	$I_{OUT} =100mA$		115		mV
	$V_{DIF2}$	$I_{OUT} =400mA$		450		mV
	$V_{DIF3}$	$I_{OUT} =800mA$		940		mV
	$V_{DIF4}$	$I_{OUT} =1000mA$		1600		mV
Quiescent Current	$I_{ss}$	$V_{IN}= V_{OUT}+1.2V$		52		$\mu A$
Line Regulation	$\Delta V_{OUT}$	$I_{OUT} =0mA$ $V_{OUT}+1.2V \leq V_{IN} \leq 18V$		2		mV
Thermal Shutdown Protection	$T_{sd}$	$I_{OUT}=10mA$ $V_{IN}= V_{OUT}+1.2V$		160		$^{\circ}C$
Over Current Protection	$I_{limit}$	$V_{IN}=3.5V$		1.1		A

### ME6118A25/E25/H25/L25 (Packages:SOT223 , SOT89-3,TO252-2L)

( $V_{IN}= V_{OUT}+1.2V$ ,  $C_{IN}=C_L=10\mu F$ ,  $T_a=25^{\circ}C$ , unless otherwise noted)

Parameter	Symbol	Conditions	Min.	Typ.	Max.	Units
Output Voltage	$V_{OUT}(E)$ (Note 2)	$I_{OUT}=10mA,$ $V_{IN}= V_{OUT}+1.2V$	X 0.98	$V_{OUT}(T)$ (Note 1)	X 1.02	V
Maximum Output Current	$I_{OUTMAX}$	$V_{IN}= V_{OUT}+1.2V$		800		mA
Load Regulation	$\Delta V_{OUT}$	$V_{IN}= V_{OUT}+1.2V$ , $1mA \leq I_{OUT} \leq 800mA$		5		mV
Dropout Voltage (Note 3)	$V_{DIF1}$	$I_{OUT} =100mA$		90		mV
	$V_{DIF2}$	$I_{OUT} =500mA$		450		mV
	$V_{DIF3}$	$I_{OUT} =800mA$		790		mV
	$V_{DIF4}$	$I_{OUT} =1000mA$		1300		mV
Quiescent Current	$I_{ss}$	$V_{IN}= V_{OUT}+1.2V$		53		$\mu A$
Line Regulation	$\Delta V_{OUT}$	$I_{OUT} =0mA$ $V_{OUT}+1.2V \leq V_{IN} \leq 18V$		2		mV
Thermal Shutdown	$T_{sd}$	$I_{OUT}=10mA,$		160		$^{\circ}C$

Protection		$V_{IN} = V_{OUT} + 1.2V$			
Over Current Protection	$I_{limit}$	$V_{IN} = 4.0V$		1.1	A

### ME6118A33/E33/H33/L33 (Packages: SOT223, SOT89-3, TO252-2L)

( $V_{IN} = V_{OUT} + 1.2V$ ,  $C_{IN} = C_L = 10\mu F$ ,  $T_a = 25^\circ C$ , unless otherwise noted)

Parameter	Symbol	Conditions	Min.	Typ.	Max.	Units
Output Voltage	$V_{OUT(E)}$ (Note 2)	$I_{OUT} = 10mA$ , $V_{IN} = V_{OUT} + 1.2V$	X 0.98	$V_{OUT(T)}$ (Note 1)	X 1.02	V
Maximum Output Current	$I_{OUTMAX}$	$V_{IN} = V_{OUT} + 1.2V$		800		mA
Load Regulation	$\Delta V_{OUT}$	$V_{IN} = V_{OUT} + 1.2V$ , $1mA \leq I_{OUT} \leq 800mA$		7		mV
Dropout Voltage (Note 3)	$V_{DIF1}$	$I_{OUT} = 100mA$		80		mV
	$V_{DIF2}$	$I_{OUT} = 500mA$		400		mV
	$V_{DIF3}$	$I_{OUT} = 800mA$		680		mV
	$V_{DIF4}$	$I_{OUT} = 1000mA$		1300		mV
Quiescent Current	$I_{SS}$	$V_{IN} = V_{OUT} + 1.2V$		53		$\mu A$
Line Regulation	$\Delta V_{OUT}$	$I_{OUT} = 0mA$ $V_{OUT} + 1.2V \leq V_{IN} \leq 18V$		2		mV
Thermal Shutdown Protection	$T_{sd}$	$I_{OUT} = 10mA$ , $V_{IN} = V_{OUT} + 1.2V$		160		$^\circ C$
Over Current Protection	$I_{limit}$	$V_{IN} = 5.0V$		1.1		A

### ME6118A33 (Package: SOT23-3)

( $V_{IN} = V_{OUT} + 1.2V$ ,  $C_{IN} = C_L = 10\mu F$ ,  $T_a = 25^\circ C$ , unless otherwise noted)

Parameter	Symbol	Conditions	Min.	Typ.	Max.	Units
Output Voltage	$V_{OUT(E)}$ (Note 2)	$I_{OUT} = 10mA$ , $V_{IN} = V_{OUT} + 1.2V$	X 0.98	$V_{OUT(T)}$ (Note 1)	X 1.02	V
Maximum Output Current	$I_{OUTMAX}$	$V_{IN} = V_{OUT} + 1.2V$		500		mA
Load Regulation	$\Delta V_{OUT}$	$V_{IN} = V_{OUT} + 1.2V$ , $1mA \leq I_{OUT} \leq 500mA$		10		mV
Dropout Voltage (Note 3)	$V_{DIF1}$	$I_{OUT} = 100mA$		70		mV
	$V_{DIF2}$	$I_{OUT} = 300mA$		220		mV
	$V_{DIF3}$	$I_{OUT} = 500mA$		385		mV
Quiescent Current	$I_{SS}$	$V_{IN} = V_{OUT} + 1.2V$		53		$\mu A$
Line Regulation	$\Delta V_{OUT}$	$I_{OUT} = 0mA$ $V_{OUT} + 1.2V \leq V_{IN} \leq 18V$		2		mV
Thermal Shutdown Protection	$T_{sd}$	$I_{OUT} = 10mA$ , $V_{IN} = V_{OUT} + 1.2V$		160		$^\circ C$
Over Current Protection	$I_{limit}$	$V_{IN} = 5.0V$		1.1		A

## ME6118A50/E50/H50/L50 (Packages:SOT223 , SOT89-3,TO252-2L)

( $V_{IN}=V_{OUT}+1.2V$ ,  $C_{IN}=C_L=10\mu F$ ,  $T_a=25^{\circ}C$ , unless otherwise noted)

Parameter	Symbol	Conditions	Min.	Typ.	Max.	Units
Output Voltage	$V_{OUT(E)}$ (Note 2)	$I_{OUT}=10mA$ , $V_{IN}=V_{OUT}+1.2V$	X 0.98	$V_{OUT(T)}$ (Note 1)	X 1.02	V
Maximum Output Current	$I_{OUTMAX}$	$V_{IN}=V_{OUT}+1.2V$		800		mA
Load Regulation	$\Delta V_{OUT}$	$V_{IN}=V_{OUT}+1.2V$ , $1mA \leq I_{OUT} \leq 800mA$		8		mV
Dropout Voltage (Note 3)	$V_{DIF1}$	$I_{OUT}=100mA$		60		mV
	$V_{DIF2}$	$I_{OUT}=500mA$		300		mV
	$V_{DIF3}$	$I_{OUT}=800mA$		500		mV
	$V_{DIF4}$	$I_{OUT}=1000mA$		900		mV
Quiescent Current	$I_{SS}$	$V_{IN}=V_{OUT}+1.2V$		53		uA
Line Regulation	$\Delta V_{OUT}$	$I_{OUT}=0mA$ $V_{OUT}+1.2V \leq V_{IN} \leq 18V$		2		mV
Thermal Shutdown Protection	$T_{SD}$	$I_{OUT}=10mA$ , $V_{IN}=V_{OUT}+1.2V$		160		$^{\circ}C$
Over Current Protection	$I_{LIMIT}$	$V_{IN}=6.5V$		1.1		A

Note :

- $V_{OUT(T)}$  : Specified Output Voltage
- $V_{OUT(E)}$  : Effective Output Voltage ( ie. The output voltage when " $V_{OUT(T)}+1.2V$ " is provided at the  $V_{IN}$  pin while maintaining a certain  $I_{OUT}$  value.)
- $V_{DIF}$ :  $V_{IN1}-V_{OUT(E)}$   
 $V_{IN1}$  : The input voltage when  $V_{OUT(E)}$  appears as input voltage is gradually decreased.  
 $V_{OUT(E)}$  = A voltage equal to 98% of the output voltage whenever an amply stabilized  $I_{OUT}$  and  $\{V_{OUT(T)}+1.2V\}$  is input.

## Type Characteristics

(1) Output Voltage VS. Output Current

**ME6118A12B3G** ( $V_{IN}=V_{OUT}+1.3V$ )

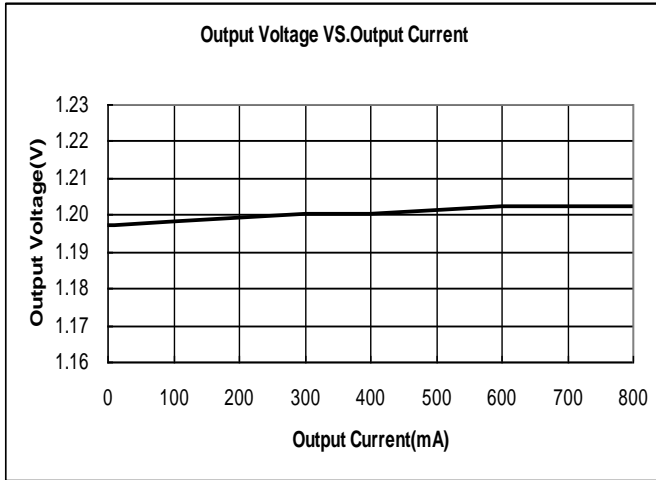

**ME6118A18B3G** ( $V_{IN}=V_{OUT}+1.2V$ )

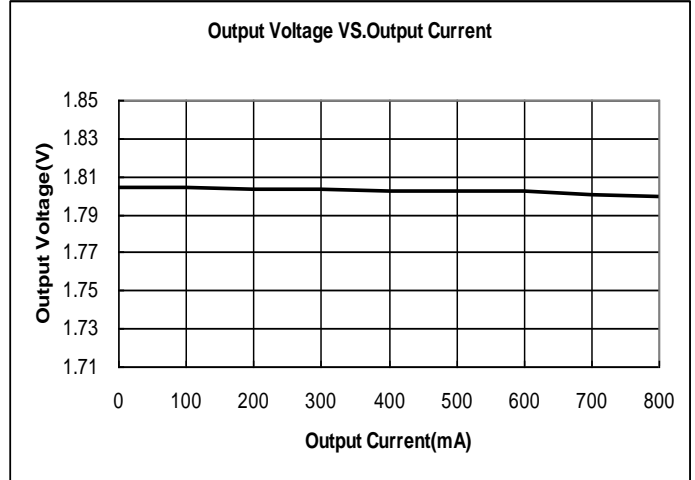

**ME6118A25B3G** ( $V_{IN}=V_{OUT}+1.2V$ )

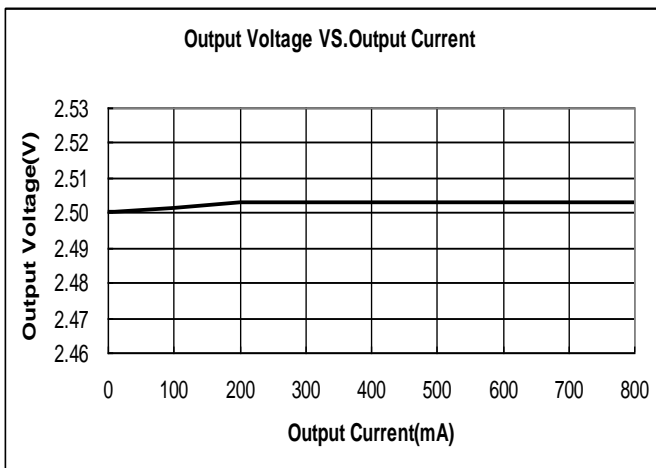

**ME6118A33B3G** ( $V_{IN}=V_{OUT}+1.2V$ )

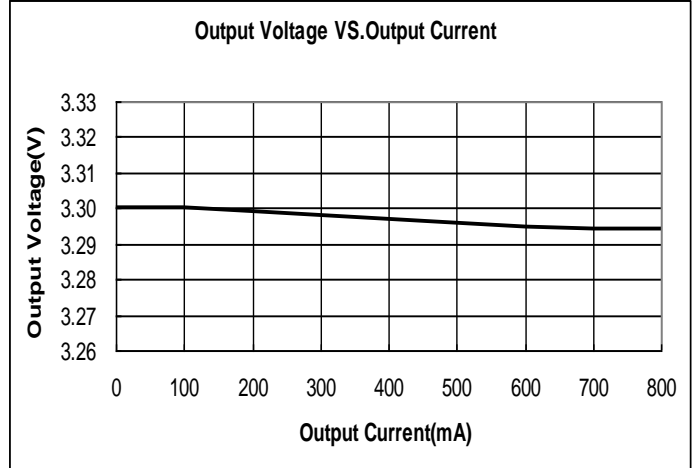

(2) Output Voltage VS. Temperature

**ME6118A12B3G** ( $V_{IN}=V_{OUT}+1.3V$ ,  $I_{OUT}=10mA$ )

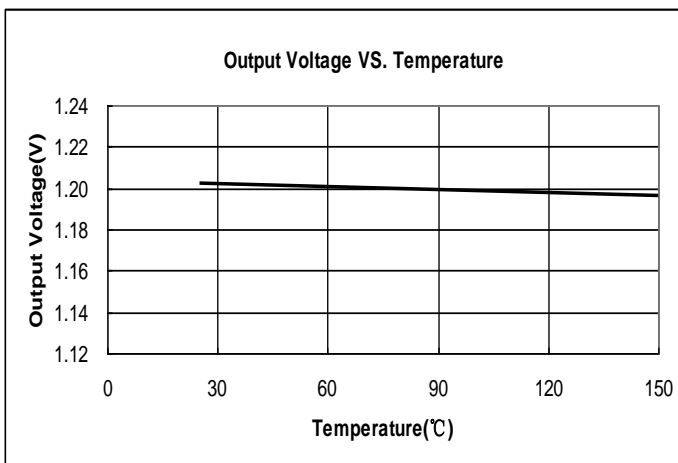

**ME6118A18B3G** ( $V_{IN}=V_{OUT}+1.2V$ ,  $I_{OUT}=10mA$ )

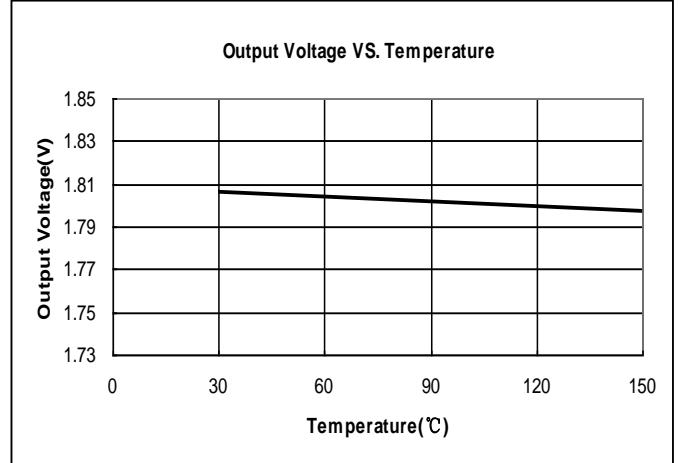



**ME6118A25B3G** ( $V_{IN}=V_{OUT}+1.2V$ ,  $I_{OUT}=10mA$ )

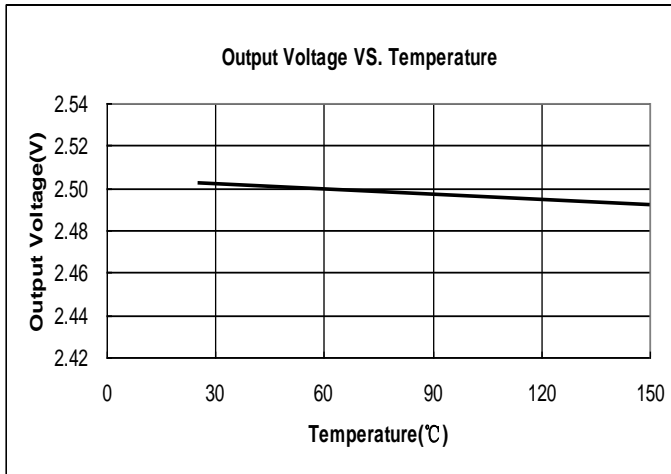

**ME6118A33B3G** ( $V_{IN}=V_{OUT}+1.2V$ ,  $I_{OUT}=10mA$ )

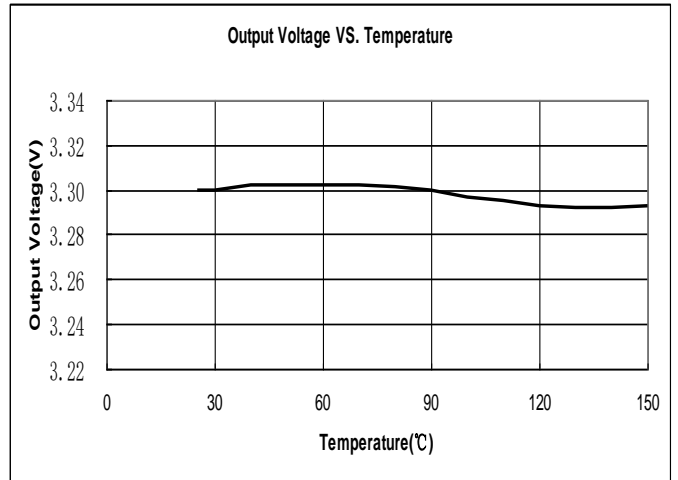

(3) Dropout Voltage VS. Output Current ( $T_a = 25^\circ C$ )

**ME6118A12B3G**

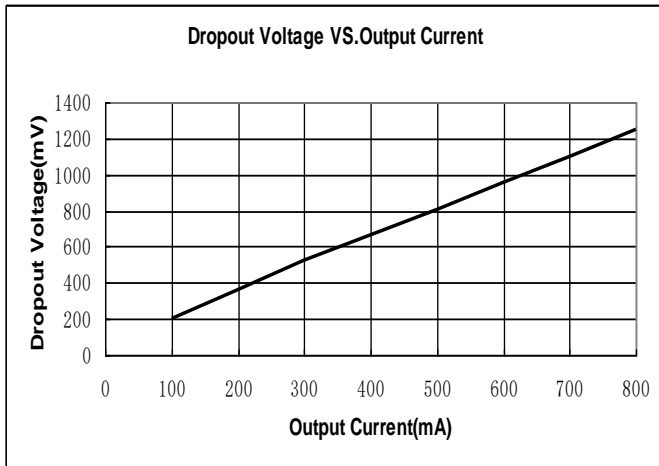

**ME6118A18B3G**

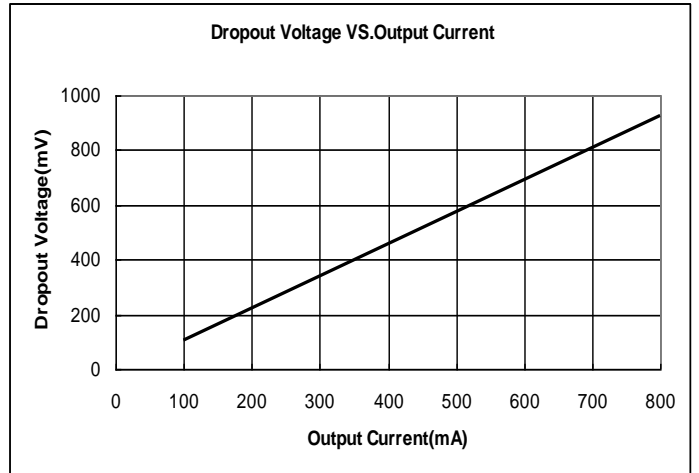

**ME6118A25B3G**

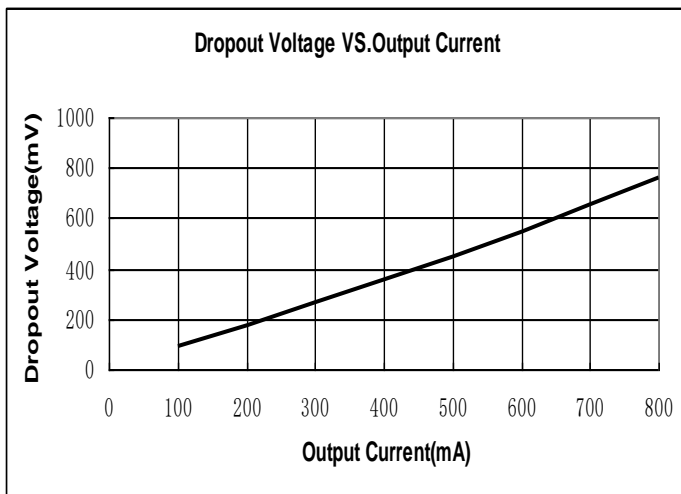

**ME6118A33B3G**

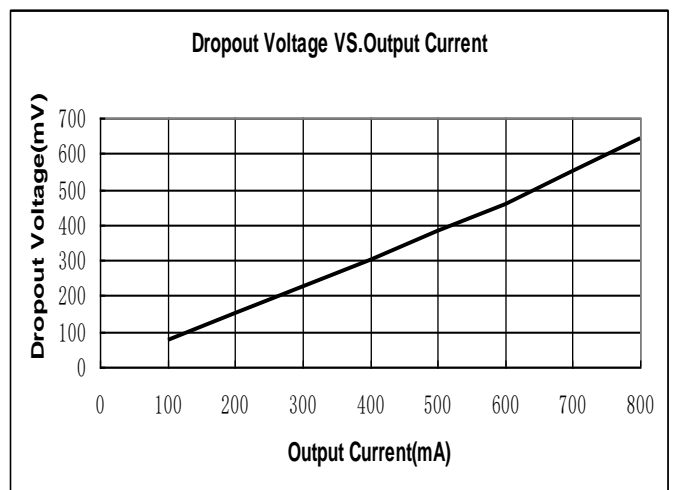

(4) Output Voltage VS. Input Voltage (Ta = 25 °C)

**ME6118A12B3G**

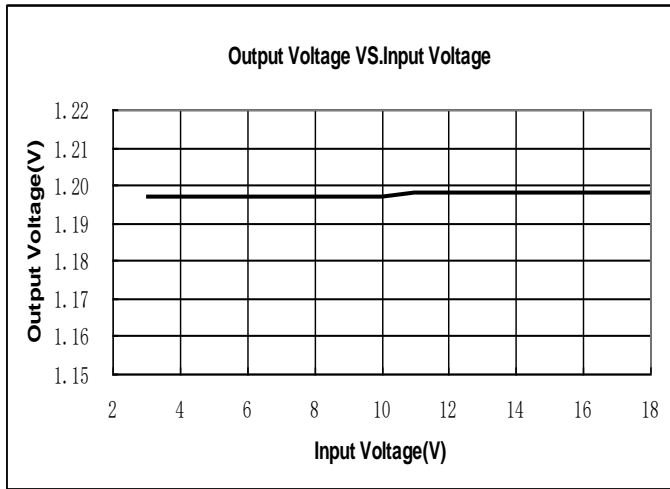

**ME6118A18B3G**

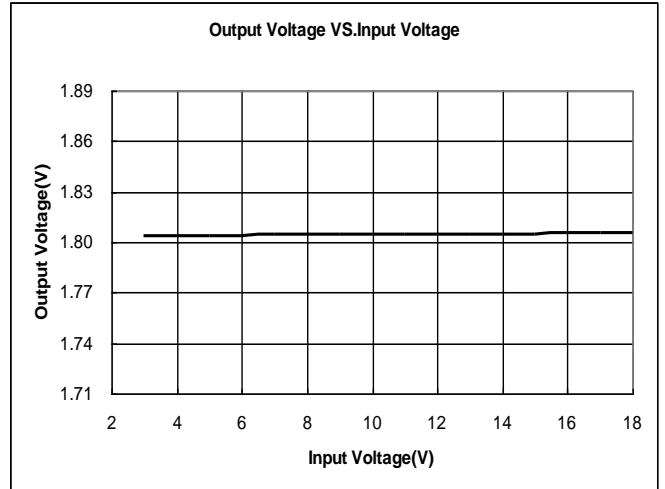

**ME6118A25B3G**

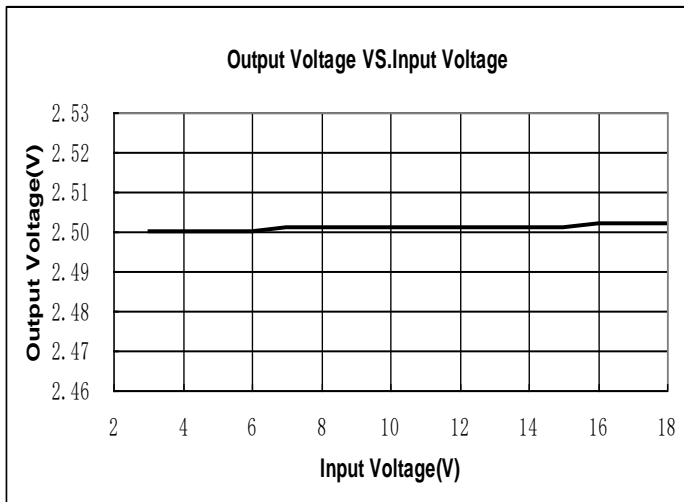

**ME6118A33B3G**

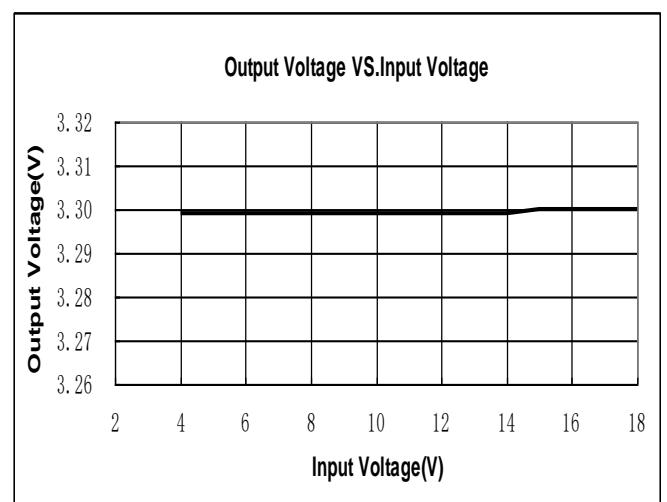

(5) Quiescent Current VS. Input Voltage

**ME6118A12B3G**

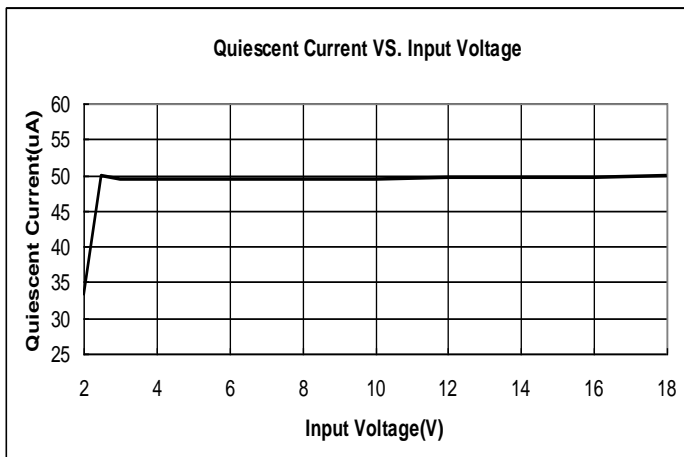

**ME6118A18B3G**

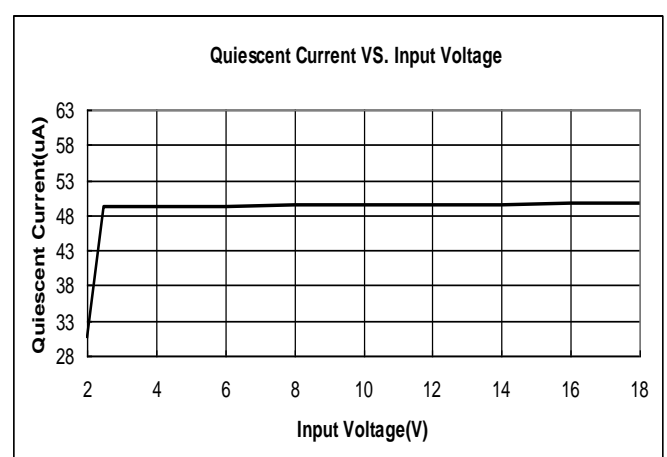

## ME6118A25B3G

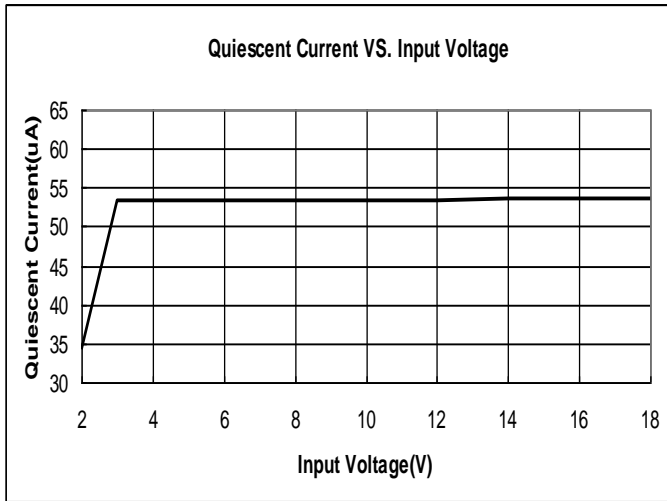

## ME6118A33B3G

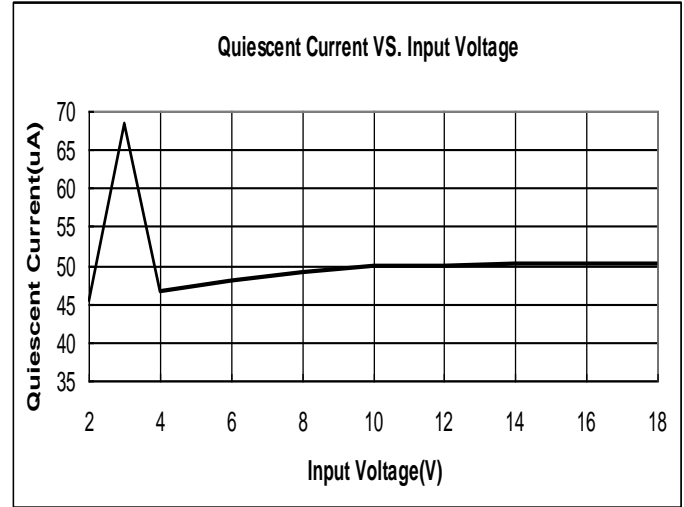

## Applications Information

### 1. Input Bypass Capacitor

An input capacitor is recommended. A 10uF tantalum on the input is a suitable input bypassing for almost all applications.

### 2. Output Capacitor

The output capacitor is critical in maintaining regulator stability, and must meet the required conditions for both minimum amount of capacitance and ESR (Equivalent Series Resistance). The minimum output capacitance required by the ME6118 is 10μF, if a tantalum capacitor is used. Any increase of the output capacitance will merely improve the loop stability and transient response. The ESR of the output capacitor should be less than 0.5Ω.

### 3. Load Regulation

The ME6118 regulates the voltage that appears between its output and ground pins, or between its output and adjust pins. In some cases, line resistances can introduce errors to the voltage across the load. To obtain the best load regulation, a few precautions are needed. Figure1, shows a typical application using a fixed output regulator. The  $R_{t1}$  and  $R_{t2}$  are the line resistances. It is obvious that the  $V_{LOAD}$  is less than the  $V_{OUT}$  by the sum of the voltage drops along the line resistances. In this case, the load regulation seen at the  $R_{LOAD}$  would be degraded from the datasheet specification. To improve this, the load should be tied directly to the output terminal on the positive side and directly tied to the ground terminal on the negative side.

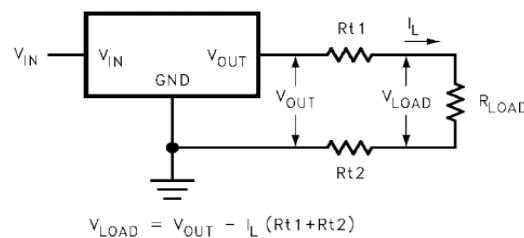
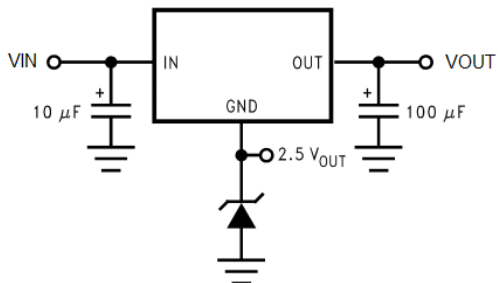

FIGURE 1. Typical Application using Fixed Output Regulator

## Application Circuit

(1) Regulator with Reference



(2) Adjusting Output of Fixed Voltage Regulators

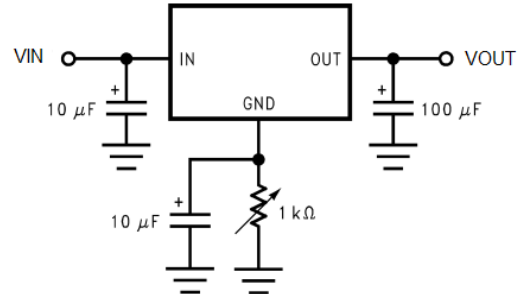

(3) Battery Backed-Up Power Supply

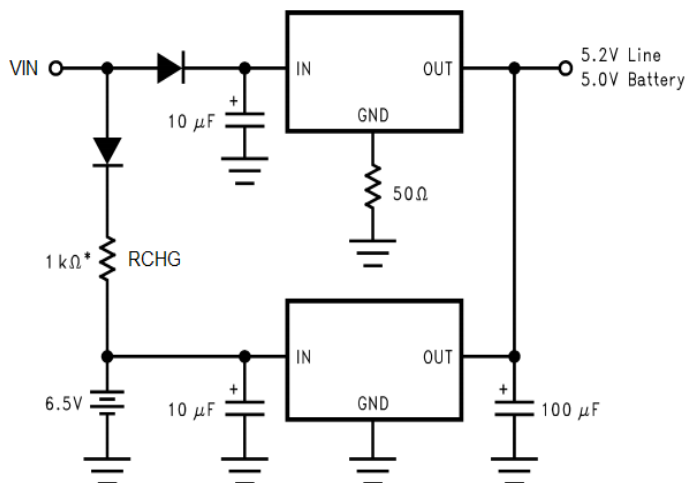

\* Select for charge rate.

(4) Low Dropout Negative Supply

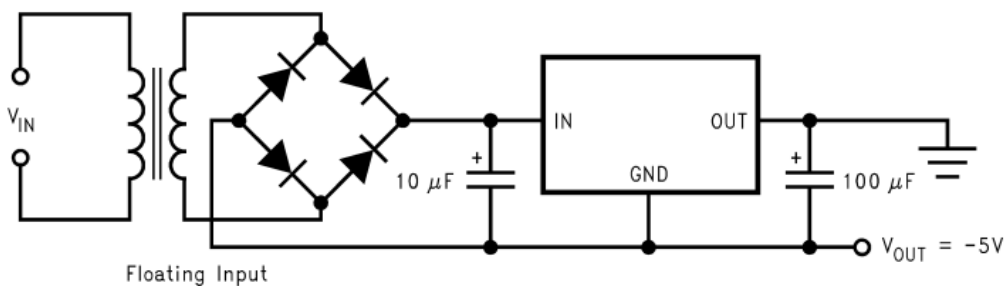

## Packaging Information

- SOT223

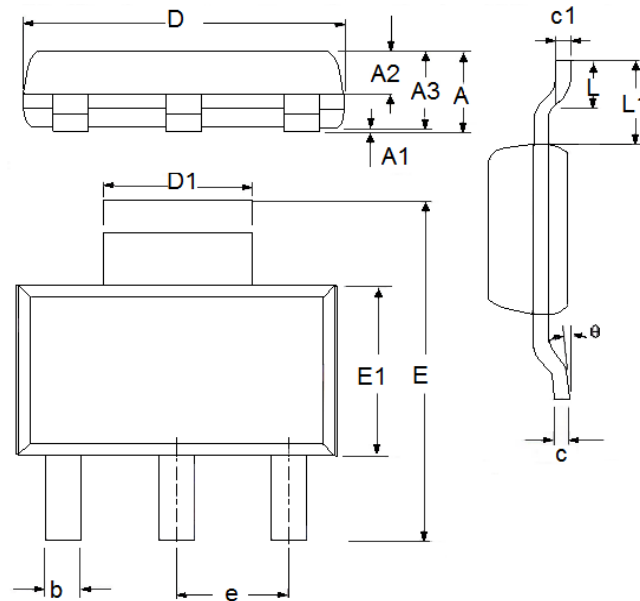

DIM	Millimeters		Inches	
	Min	Max	Min	Max
A	1.5	1.8	0.0591	0.0709
A1	0	0.12	0.0000	0.0047
A2	1.45	1.75	0.0571	0.0689
A3	0.85	0.95	0.0335	0.0374
b	0.6	0.82	0.0236	0.0323
c	0.24	0.35	0.0094	0.0138
D	6.2	6.6	0.2441	0.2598
D1	3.0(TYP)		0.1181(TYP)	
E	6.7	7.3	0.2638	0.2784
E1	3.3	3.7	0.1299	0.1457
e	2.3(TYP)		0.0906(TYP)	
L	0.9	1.15	0.0354	0.0453
L1	1.75(TYP)		0.0689(TYP)	
θ	0	10°	0.0000	10°
c1	0.25(TYP)		0.0098(TYP)	

● SOT23-3

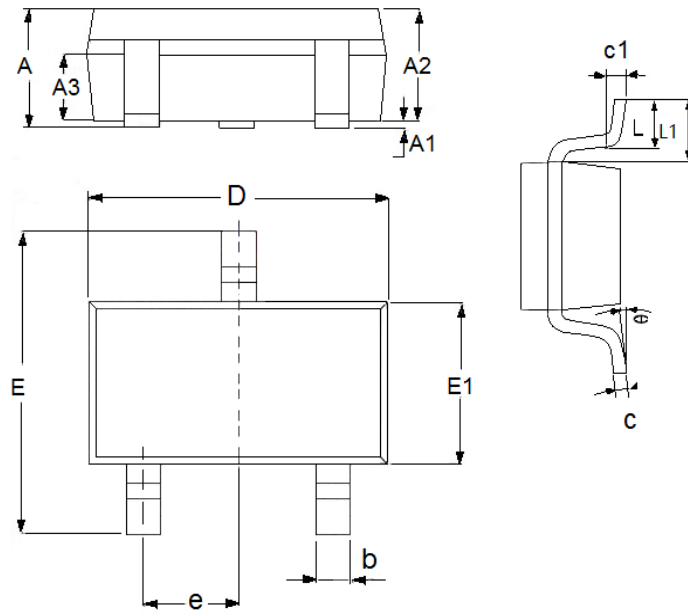

DIM	Millimeters		Inches	
	Min	Max	Min	Max
A	1.0	1.5	0.0394	0.0591
A1	0	0.15	0.0000	0.0059
A2	0.9	1.3	0.0354	0.0512
A3	0.6	0.7	0.0236	0.0276
b	0.25	0.5	0.0098	0.0197
c	0.1	0.25	0.0039	0.0098
D	2.8	3.1	0.1102	0.1220
E	2.6	3.1	0.1023	0.1220
E1	1.5	1.8	0.0591	0.0709
e	0.95(TYP)		0.0374(TYP)	
L	0.25	0.6	0.0098	0.0236
L1	0.59(TYP)		0.0232(TYP)	
$\theta$	0	8°	0.0000	8°
c1	0.2(TYP)		0.0079(TYP)	
L1	0.59(TYP)		0.0232(TYP)	
$\theta$	0	8°	0.0000	8°
c1	0.2(TYP)		0.0079(TYP)	

● TO252-2L

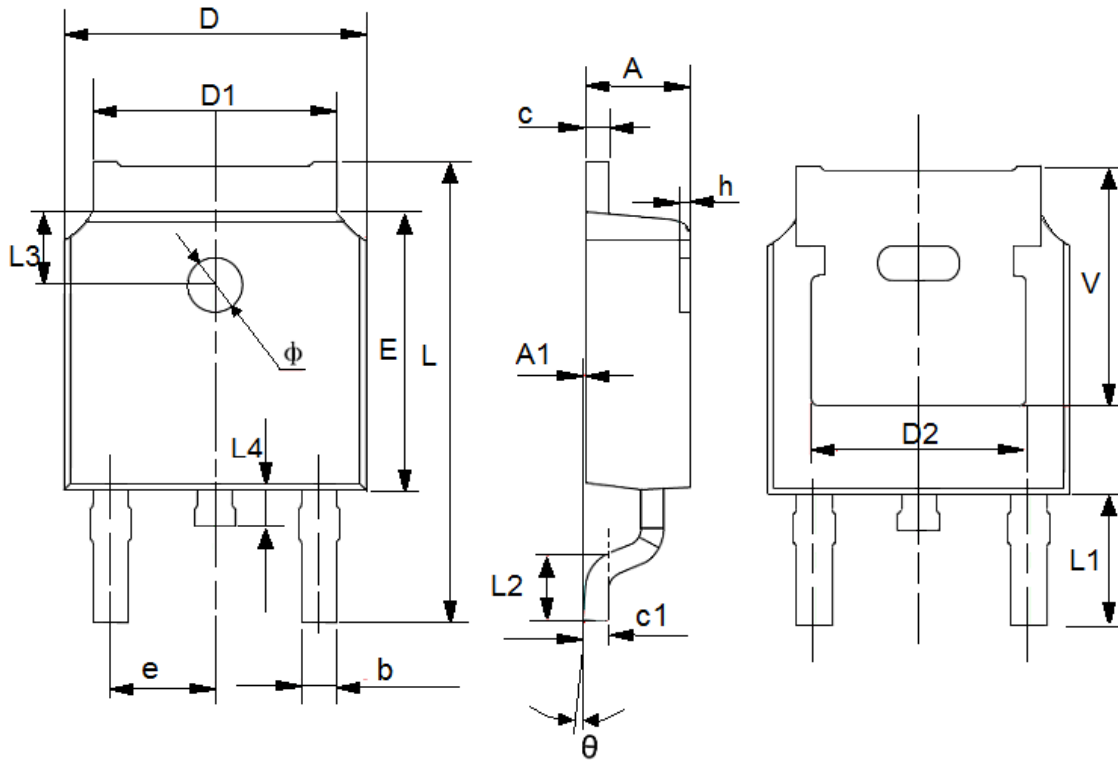

DIM	Millimeters		Inches	
	Min	Max	Min	Max
A	2.2	2.4	0.0866	0.0945
A1	0	0.127	0	0.005
b	0.66	0.86	0.026	0.0339
c	0.46	0.58	0.0181	0.0228
c1	0.498	0.6	0.0196	0.0236
D	6.5	6.7	0.2559	0.2638
D1	5.33(TYP)		0.2098(TYP)	
D2	4.83(TYP)		0.1902(TYP)	
E	6	6.2	0.2362	0.2441
e	2.286(TYP)		0.09(TYP)	
L	9.8	10.4	0.3858	0.4094
L1	2.9(TYP)		0.1142(TYP)	
L2	1.4	1.7	0.0551	0.0669
L3	1.8(TYP)		0.07(TYP)	
L4	0.6	1	0.0236	0.0394
h	0	0.3	0	0.0118
Φ	1.1	1.3	0.0433	0.0512
V	5.3(TYP)		0.2087(TYP)	
θ	0	8°	0	8°

● SOT89-3

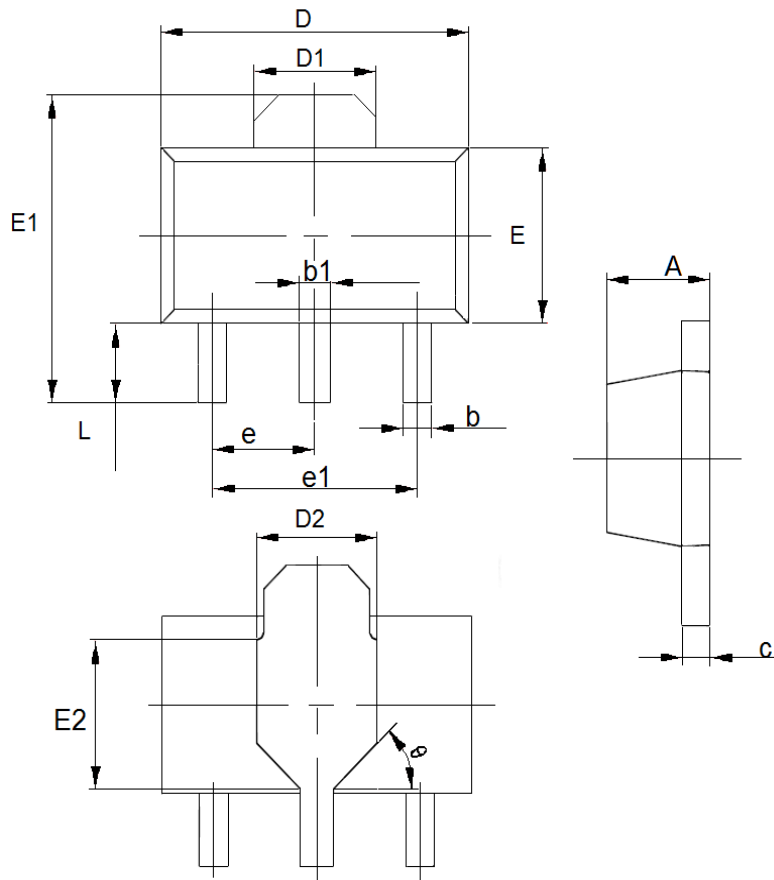

DIM	Millimeters		Inches	
	Min	Max	Min	Max
A	1.4	1.6	0.0551	0.0630
b	0.32	0.52	0.0126	0.0205
b1	0.4	0.58	0.0157	0.0228
c	0.35	0.45	0.0138	0.0177
D	4.4	4.6	0.1732	0.1811
D1	1.55(TYP)		0.061(TYP)	
D2	1.75(TYP)		0.0689(TYP)	
e1	3.0(TYP)		0.1181(TYP)	
E	2.3	2.6	0.0906	0.1023
E1	3.94	4.4	0.1551	0.1732
E2	1.9(TYP)		0.0748(TYP)	
e	1.5(TYP)		0.0591(TYP)	
L	0.8	1.2	0.0315	0.0472
$\theta$	45°		45°	



- The information described herein is subject to change without notice.
- Nanjing Micro One Electronics Inc is not responsible for any problems caused by circuits or diagrams described herein whose related industrial properties, patents, or other rights belong to third parties. The application circuit examples explain typical applications of the products, and do not guarantee the success of any specific mass-production design.
- Use of the information described herein for other purposes and/or reproduction or copying without the express permission of Nanjing Micro One Electronics Inc is strictly prohibited.
- The products described herein cannot be used as part of any device or equipment affecting the human body, such as exercise equipment, medical equipment, security systems, gas equipment, or any apparatus installed in airplanes and other vehicles, without prior written permission of Nanjing Micro One Electronics Inc.
- Although Nanjing Micro One Electronics Inc exerts the greatest possible effort to ensure high quality and reliability, the failure or malfunction of semiconductor products may occur. The user of these products should therefore give thorough consideration to safety design, including redundancy, fire-prevention measures, and malfunction prevention, to prevent any accidents, fires, or community damage that may ensue.

## X-ON Electronics

Largest Supplier of Electrical and Electronic Components

*Click to view similar products for [LDO Voltage Regulators](#) category:*

*Click to view products by [Micro One](#) manufacturer:*

Other Similar products are found below :

[AP7363-SP-13](#) [L79M05TL-E](#) [AP7362-HA-7](#) [PT7M8202B12TA5EX](#) [TCR3DF185,LM\(CT](#) [TCR3DF45,LM\(CT](#) [TLE4473G V52](#) [059985X](#)  
[NCP4687DH15T1G](#) [701326R](#) [NCV8170AXV250T2G](#) [AP7315-25W5-7](#) [AP2111H-1.2TRG1](#) [ZLDO1117QK50TC](#) [AZ1117ID-ADJTRG1](#)  
[TCR3DG12,LF](#) [MIC5514-3.3YMT-T5](#) [SCD7912BTG](#) [NCP154MX180270TAG](#) [SCD33269T-5.0G](#) [NCV8170BXV330T2G](#)  
[NCV8170BMX330TCG](#) [NCV8170AMX120TCG](#) [NCP706ABMX300TAG](#) [NCP153MX330180TCG](#) [NCP114BMX075TCG](#) [MC33269T-3.5G](#)  
[CAT6243-ADJCMT5T](#) [TCR3DG33,LF](#) [TCR4DG35,LF](#) [TAR5S15U\(TE85L,F\)](#) [TAR5S18U\(TE85L,F\)](#) [TCR3UG19A,LF](#) [TCR4DG105,LF](#)  
[MPQ2013AGG-5-P](#) [NCV8170AMX360TCG](#) [TLE4268GSXUMA2](#) [NCP715SQ15T2G](#) [MIC5317-3.0YD5-T5](#) [NCV563SQ18T1G](#)  
[NCP715MX30TBG](#) [NCV8702MX25TCG](#) [NCV8170BXV120T2G](#) [MIC5317-1.2YD5-T5](#) [NCV8170AMX150TCG](#) [NCV8170BMX150TCG](#)  
[AP2213D-3.3TRG1](#) [NCV8170BMX120TCG](#) [NCV8170BMX310TCG](#) [NCV8170BMX360TCG](#)