

12/01/2014

Features:

- High Reliability
- Electrically similar to 4N47, 4N48, 4N49
- Base lead eliminated for improved noise immunity
- Rugged package
- +1 kV electrical isolation
- Stability over wide temperature range

Applications:

- Eliminate ground loops
- Level shifting
- Line receiver
- Switching power supplies
- Motor control

DESCRIPTION

The **66133** contains an infrared LED optically coupled to a silicon phototransistor in a hermetic 4 lead TO-18 package. The collector of the phototransistor is electrically connected to the case. The internal base connection has been eliminated for improved noise immunity. The 3N261, 3N262 and 3N263 can be supplied to commercial or screened quality levels as well as to customer specifications.

ABSOLUTE MAXIMUM RATINGS

Input to Output Voltage.....	1000 V
Emitter-Collector Voltage.....	7 V
Collector-Emitter Voltage.....	40 V
Reverse Input Voltage	2 V
Input Diode Continuous Forward Current at (or below) 65°C Free-Air Temperature (see note 1).....	40 mA
Continuous Collector Current	20 mA
Continuous Transistor Power Dissipation at (or below) 25°C Free-Air Temperature (see Note 2)	190 mW
Storage Temperature.....	-55°C to +150°C
Operating Free-Air Temperature Range.....	-55°C to +125°C
Lead Solder Temperature (10 seconds max, 1/16" from case).....	240°C

Notes:

1. Derate linearly to 125°C free-air temperature at the rate of 0.67 mA/°C.
2. Derate linearly to 125°C free-air temperature at the rate of 1.9 mW/°C.

Package Dimensions

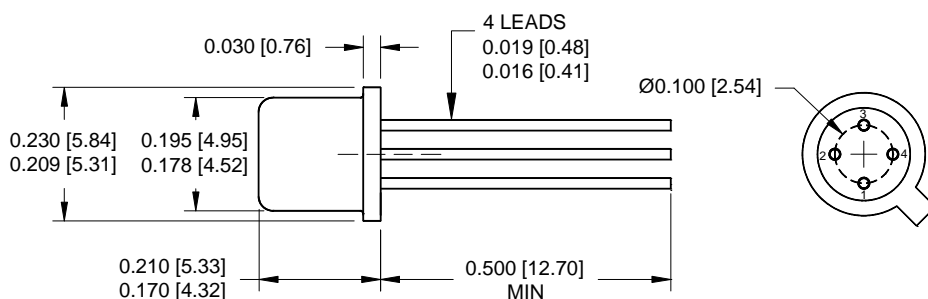

ALL DIMENSIONS ARE IN INCHES [MILLIMETERS]

Schematic Diagram

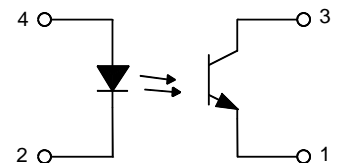

THE COLLECTOR IS IN ELECTRICAL CONTACT WITH THE CASE.

Micropac Industries cannot assume any responsibility for any circuits shown or represent that they are free from patent infringement. Micropac reserves the right to make changes at any time in order to improve design and to supply the best product possible.

66133 **3N261**
3N262
3N263

TO-18 OPTOCOUPLEDERS

12/01/2014

ELECTRICAL CHARACTERISTICS
INPUT LED

T_A = 25°C

PARAMETER	SYMBOL	MIN	TYP	MAX	UNITS	TEST CONDITIONS
Input Diode Static Reverse Current	I _R			100	nA	V _R = 2 V
Input Diode Static Forward Voltage	V _F	0.8		1.5	V	I _F = 10 mA

OUTPUT TRANSISTOR

T_A = 25°C

PARAMETER	SYMBOL	MIN	TYP	MAX	UNITS	TEST CONDITIONS
Collector-Emitter Breakdown Voltage	V _{(BR)CEO}	40			V	I _C = 1 mA, I _F = 0
Emitter-Collector Breakdown Voltage	V _{(BR)ECO}	7			V	I _E = 100 μA, I _F = 0
Collector Dark Current	I _D			100	nA	V _{CE} = 20 V, I _F = 0 mA

COUPLED CHARACTERISTICS

T_A = 25°C

PARAMETER	SYMBOL	MIN	TYP	MAX	UNITS	TEST CONDITIONS
On State Collector Current	I _{C(ON)}	0.5			mA	V _{CE} = 5 V, I _F = 1 mA
On State Collector Current	I _{C(ON)}	1			mA	V _{CE} = 5 V, I _F = 1 mA
On State Collector Current	I _{C(ON)}	2			mA	V _{CE} = 5 V, I _F = 1 mA
Collector-Emitter Saturation Voltage	V _{CE(SAT)}			0.3	V	I _F = 2 mA, I _C = 0.5 mA I _F = 2 mA, I _C = 1 mA I _F = 2 mA, I _C = 2 mA
Rise Time	t _r		10 10 15	20 20 25	μs	V _{CE} = 10 V, I _F = 5 mA, R _L = 100 Ω
Fall Time	t _f		10 10 15	20 20 25	μs	V _{CE} = 10 V, I _F = 5 mA, R _L = 100 Ω
DC Isolation Voltage	V _{IO}	1000			V	I _{IO} = 100 nA

RECOMMENDED OPERATING CONDITIONS:

PARAMETER	SYMBOL	MIN	MAX	UNITS
Input Current, Low Level	I _{FL}	0	10	μA
Input Current, High Level	I _{FH}	1	20	mA
Supply Voltage	V _{CE}	5	10	V

SELECTION GUIDE

PART NUMBER	PART DESCRIPTION
66133-001	3N261, Commercial
66133-002	3N262, Commercial
66133-003	3N263, Commercial
66133-101	3N261R, Screened
66133-102	3N262R, Screened
66133-103	3N263R, Screened

Micropac Industries cannot assume any responsibility for any circuits shown or represent that they are free from patent infringement. Micropac reserves the right to make changes at any time in order to improve design and to supply the best product possible.

12/01/2014

PARAMETER MEASUREMENT INFORMATION

ADJUST AMPLITUDE OF INPUT PULSE FOR $I_{F(ON)} = 5 \text{ mA}$

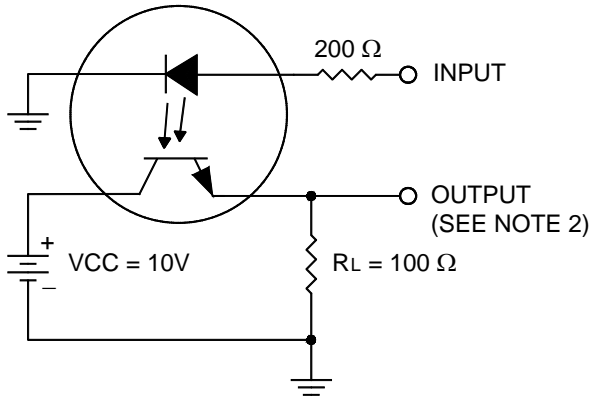

TEST CIRCUIT

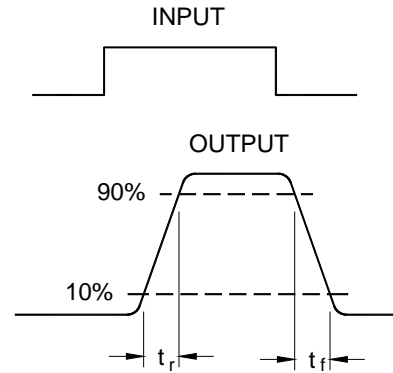

VOLTAGE WAVEFORM

- NOTES: 1. The input waveform is supplied by a generator with the following characteristics: $Z_{OUT} = 50 \Omega$, $t_r \leq 15 \text{ ns}$, Duty cycle $\approx 1\%$, $t_w = 100 \mu\text{s}$.
 2. Waveforms are monitored on an oscilloscope with the following characteristics: $t_r \leq 12 \text{ ns}$, $R_{IN} \geq 1 \text{ M}\Omega$, $C_{IN} \leq 20 \text{ pF}$

TYPICAL CHARACTERISTICS

INPUT DIODE FORWARD CONDUCTION CHARACTERISTICS

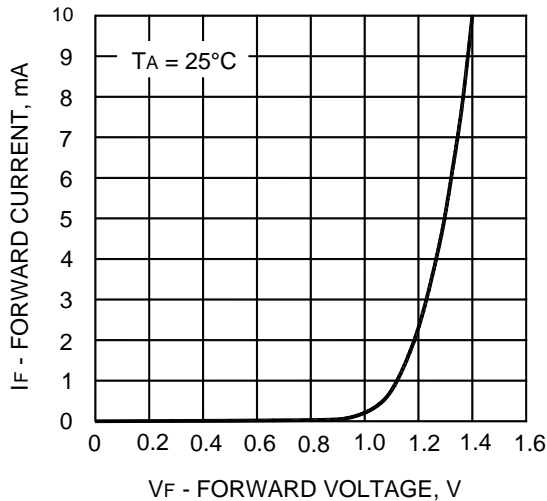

3N262
 COLLECTOR CURRENT
 vs
 INPUT DIODE FORWARD CURRENT

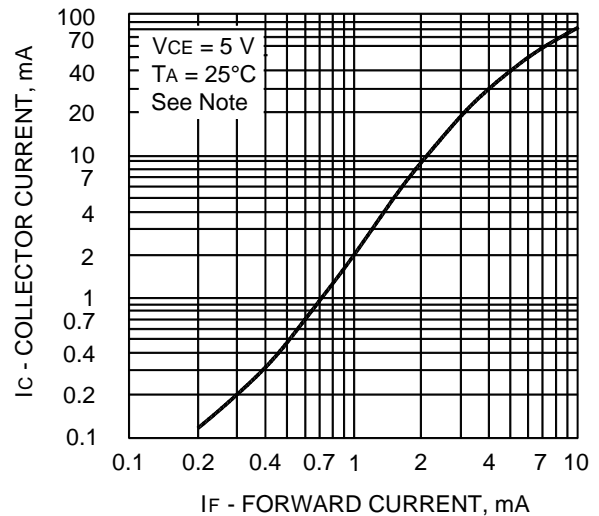

NOTE: This parameter was measured using pulse techniques. $t_w = 100 \mu\text{s}$, duty cycle = 1%.

Micropac Industries cannot assume any responsibility for any circuits shown or represent that they are free from patent infringement. Micropac reserves the right to make changes at any time in order to improve design and to supply the best product possible.

12/01/2014

TYPICAL CHARACTERISTICS (CONTINUED)

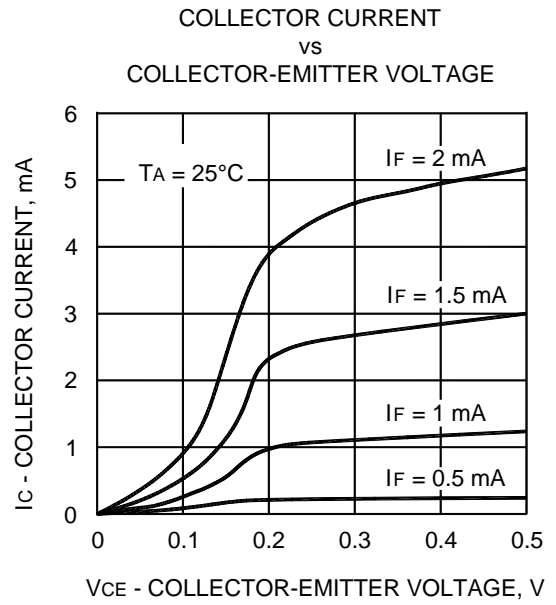
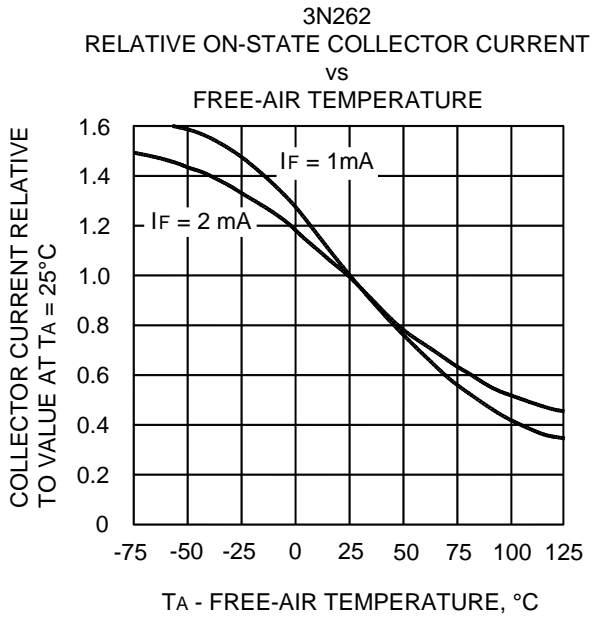

Micropac Industries cannot assume any responsibility for any circuits shown or represent that they are free from patent infringement. Micropac reserves the right to make changes at any time in order to improve design and to supply the best product possible.

X-ON Electronics

Largest Supplier of Electrical and Electronic Components

Click to view similar products for [Transistor Output Optocouplers](#) category:

Click to view products by [Micropac](#) manufacturer:

Other Similar products are found below :

[LTV-814S-TA](#) [LTV-815S-TA](#) [LTV-8241S](#) [LTV-824HS](#) [LTV-852S](#) [66095-001](#) [6N136-X017T](#) [6N136-X019T](#) [MCT6-X007](#) [MCT6-X007T](#)
[MOC8101-X009](#) [MOC8101-X017T](#) [PS2561-1-A](#) [PS2561A-1-W-A](#) [PS2561B-1-L-A](#) [PS2561DL-1Y-V-A](#) [PS2561L1-1-A](#) [PS2561L-1-V-A](#)
[PS2581AL2-A](#) [PS2706-1-A](#) [PS2815-1-A](#) [MRF658](#) [ELD207\(TA\)](#) [IL755-1X007](#) [IL755-2](#) [ILD2-X006](#) [ILD74-X001](#) [ILQ615-2X017](#) [ILQ615-3X016](#) [LDA102S](#) [LDA110S](#) [LDA202](#) [SFH601-4X007T](#) [SFH615A-2X009T](#) [SFH615A-4X001](#) [SFH615AGR-X007T](#) [SFH618A-3X006](#)
[SFH620A-2X007](#) [SFH690BT3](#) [PS2561-1-V-W-A](#) [PS2561A-1-V-A](#) [PS2561AL1-1-V-A](#) [PS2561AL-1-H-A](#) [PS2561AL-1-V-A](#) [PS2561BL-1-F3-Q-A](#) [PS2561DL-1Y-F3-A](#) [PS2561L1-1-L-A](#) [PS2561L1-1-V-Q-A](#) [PS2562-1-V-A](#) [PS2565L-1-A](#)