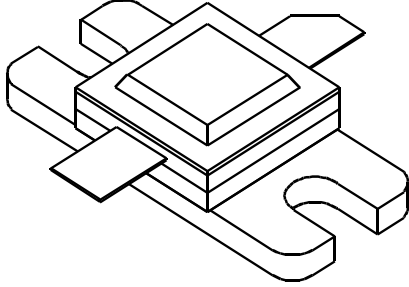

<p>GENERAL DESCRIPTION The 1214-30 is an internally matched, COMMON BASE transistor capable of providing 30 Watts of pulsed RF output power at two milliseconds pulse width, twenty percent duty factor across the band 1200 to 1400 MHz. This hermetically solder-sealed transistor is specifically designed for long pulse radar applications. It utilizes gold metalization and diffused emitter ballasting to provide high reliability and supreme ruggedness.</p>	<p>CASE OUTLINE 55AW, STYLE 1</p> 													
<p>ABSOLUTE MAXIMUM RATINGS Maximum Power Dissipation @ 25°C 88 Watts</p> <p>Maximum Voltage and Current</p> <table style="width: 100%; border: none;"> <tr> <td style="width: 15%;">BVces</td> <td style="width: 45%;">Collector to Emitter Voltage</td> <td style="width: 40%; text-align: right;">50 Volts</td> </tr> <tr> <td>BVebo</td> <td>Emitter to Base Voltage</td> <td style="text-align: right;">3.5 Volts</td> </tr> <tr> <td>Ic</td> <td>Collector Current</td> <td style="text-align: right;">4.0 Amps</td> </tr> </table> <p>Maximum Temperatures</p> <table style="width: 100%; border: none;"> <tr> <td style="width: 45%;">Storage Temperature</td> <td style="text-align: right;">- 65 to + 200°C</td> </tr> <tr> <td>Operating Junction Temperature</td> <td style="text-align: right;">+ 200°C</td> </tr> </table>	BVces	Collector to Emitter Voltage	50 Volts	BVebo	Emitter to Base Voltage	3.5 Volts	Ic	Collector Current	4.0 Amps	Storage Temperature	- 65 to + 200°C	Operating Junction Temperature	+ 200°C	
BVces	Collector to Emitter Voltage	50 Volts												
BVebo	Emitter to Base Voltage	3.5 Volts												
Ic	Collector Current	4.0 Amps												
Storage Temperature	- 65 to + 200°C													
Operating Junction Temperature	+ 200°C													

ELECTRICAL CHARACTERISTICS @ 25 °C

SYMBOL	CHARACTERISTICS	TEST CONDITIONS	MIN	TYP	MAX	UNITS
Pout	Power Out	F = 1200-1400 MHz	30			Watts
Pin	Power Input	Vcc = 28 Volts			6.0	Watts
Pg	Power Gain	Pulse Width = 2 ms	7.0			dB
η_c	Collector Efficiency	Duty = 20%		48		%
VSWR	Load Mismatch Tolerance	Rated Conditions			3:1	

BVces	Collector to Emitter Breakdown	Ic = 50 mA	50			Volts
BVebo	Emitter to Base Breakdown	Ie = 5 mA	3.5			Volts
Hfe	DC Current Gain	Vce=5 V, Ic =500mA	20			
Cob	Output Capacitance*	F=1 MHz, Vcb=28V				pF
θ_{jc}	Thermal Resistance	Rated Pulse Condition			2.0	°C/W

* Not measureable due to internal prematch network

IssueA July 1997

GHz TECHNOLOGY INC. RESERVES THE RIGHT TO MAKE CHANGES WITHOUT FURTHER NOTICE. GHz RECOMMENDS THAT BEFORE THE PRODUCT(S) DESCRIBED HEREIN ARE WRITTEN INTO SPECIFICATIONS, OR USED IN CRITICAL APPLICATIONS, THAT THE PERFORMANCE CHARACTERISTICS BE VERIFIED BY CONTACTING THE FACTORY.

GHz Technology Inc. 3000 Oakmead Village Drive, Santa Clara, CA 95051-0808 Tel. 408 / 986-8031 Fax 408 / 986-8120

POWER OUTPUT vs POWER INPUT

Vcc = 28 V, PW = 2 ms, Duty = 20%

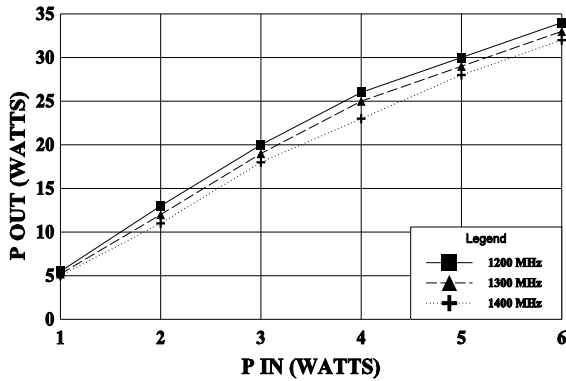

POWER OUPUT AND EFF. vs FREQUENCY

Vcc = 28 V, Pin = 6 W, 2 ms, 20%

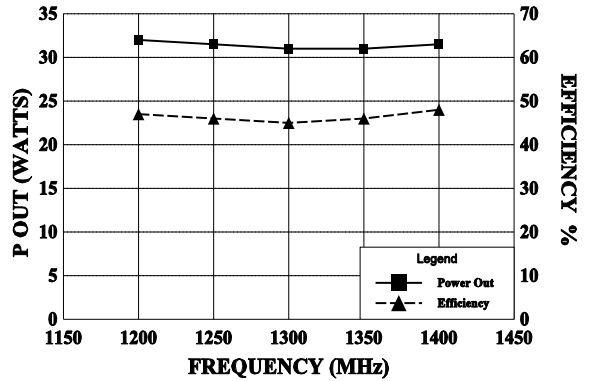

Typical Impedances

INPUT IMPEDANCE vs FREQUENCY

Zin = R + jX (Vcc = 28 V, Pin = 6 W)

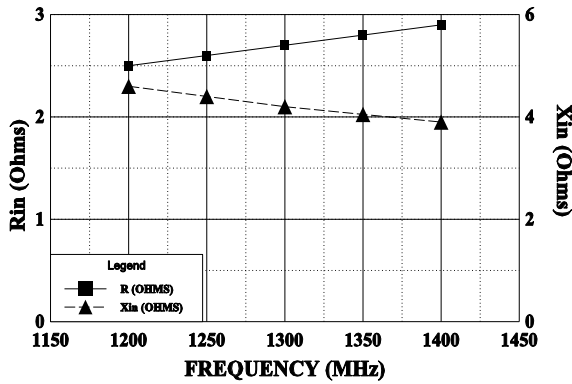

LOAD IMPEDANCE vs FREQUENCY

Zcl = Rcl - jXcl (Vcc = 28 V, Pin = 6 W)

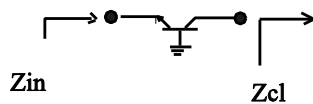
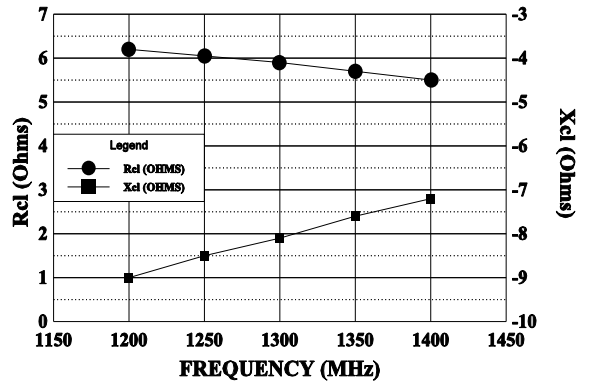

REVISIONS

ZONE	REV	DESCRIPTION	DATE	APPROVED
------	-----	-------------	------	----------

DIM	INCHES
A	.730
B	.332
C	.280
D	.030
E	.165
F	.120
G	.525
H	.270
I	.205
J	.300
K	.285
L	.433
M	.190
N	.130
O	.030
P	.250
Q	.155
R	.185
S	.185
T	.270

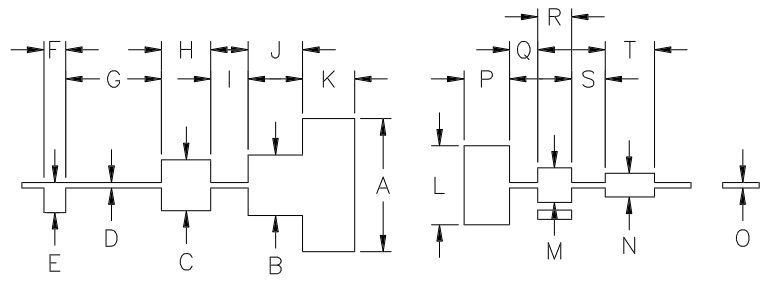

1214-30 TEST CIRCUIT

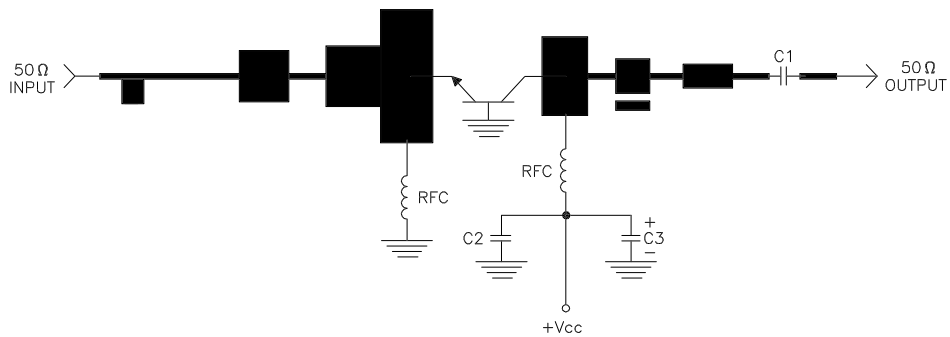

DIELECTRIC = 10 MIL THICK
 DUROID, Er = 2.3
 C1, C2 = 82pF CHIP ATC "A"
 C3 = 100MFD @ 35V
 RFC = 5 turns #22 wire 1/16" I.D.



CAGE OPJR2	DWG NO. 1214-30	REV A
	SCALE 1/1	SHEET

X-ON Electronics

Largest Supplier of Electrical and Electronic Components

Click to view similar products for [RF Bipolar Transistors](#) category:

Click to view products by [Microsemi](#) manufacturer:

Other Similar products are found below :

[MAPRST0912-50](#) [MCH4016-TL-H](#) [MMBT5551-G](#) [MRF10120](#) [15GN01CA-TB-E](#) [PH1214-25M](#) [MAPRST0912-350](#) [MMBTH10-TP](#) [BFP640F H6327](#) [BFR 360F H6765](#) [MRF10031](#) [NSVF4009SG4T1G](#) [BFP 182R E7764](#) [BFP405H6740XTSA1](#) [MRF10350](#) [ASMA201](#) [BFR360FH6765XTSA1](#) [BFP410H6327XTSA1](#) [BFP620FH7764XTSA1](#) [BFP720ESDH6327XTSA1](#) [BFP720FH6327XTSA1](#) [BFR360L3E6765XTMA1](#) [BFP420H6433XTMA1](#) [BFP420H6740XTSA1](#) [BFP420H6801XTSA1](#) [MCH4015-TL-H](#) [BF888H6327XTSA1](#) [MMBT2222A-G](#) [BFP196WH6327XTSA1](#) [BFP405FH6327XTSA1](#) [BFP640ESDH6327XTSA1](#) [BFR193L3E6327XTMA1](#) [BFS483H6327XTSA1](#) [NSVF4020SG4T1G](#) [NSVF6003SB6T1G](#) [MRF10005](#) [BFP420FH6327XTSA1](#) [BFP740FESDH6327XTSA1](#) [BFR181E6327HTSA1](#) [BFR181WH6327XTSA1](#) [BFR182E6327HTSA1](#) [BFR193E6327HTSA1](#) [BFP181E7764HTSA1](#) [BFP183WH6327XTSA1](#) [BFP720H6327XTSA1](#) [BFR182WH6327XTSA1](#) [BFU590GX](#) [MAPR-000912-500S00](#) [BFR340FH6327XTSA1](#) [STGWT30HP65FB](#)